

# Panasonic



## GENERAL CATALOGUE 2025 / 2026

PANASONIC TOTAL SOLUTION



heating & cooling solutions

## EDITORIAL



Panasonic – leading the way in Heating and Cooling. With 65 years of experience, selling to more than 120 countries around the world, Panasonic is one of the leaders in the heating and cooling sector.

### Bringing nature's balance indoors.

nanoe™ X, technology with the benefits of hydroxyl radicals that have the capacity to inhibit pollutants, viruses, and bacteria and deodorise.



## AQUAREA



Aquarea is a ground breaking low energy system for heating and domestic hot water production: delivering outstanding performance, even at extreme outdoor temperatures.

### Big Aquarea T-CAP M Series, for centralised heating and DHW.

The Big Aquarea M Series offers a flexible, compact and energy-efficient solution for central heating and/or domestic hot water installations in multi-family or commercial buildings.



## DOMESTIC



Panasonic has developed a range of domestic products designed for you and your clients.

### Power Heat multi, the multi split system engineered for cold climates.

Powerful heating of two or three rooms with one outdoor unit, even at -25 °C low outdoor temperatures.



## COMMERCIAL AIR TO AIR - PACi



The commercial range is continuously being improved to offer the optimal solutions. High performance, silent operation and a wide range of indoor units and connectivity available.

### Jet Air Stream.

The new PACi NX indoor units designed for large spaces that require high air distribution, such as gymnasiums, production areas, and warehouses. They ensure optimal user comfort, a quiet environment, and are much easier to install than other systems.

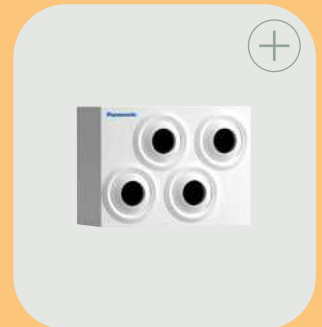

## COMMERCIAL VRF SYSTEMS - ECOi AND ECO G



Panasonic provides an extensive range of solutions for medium and large sized buildings, combining the best options to satisfy all needs and site restrictions.

### New ECOi EX MZ1 Series R32.

Extreme efficiency, quality, compact. With advanced R32 refrigerant technology and optimised system design, this series offers a more sustainable solution compared to R410A.



## VENTILATION



Panasonic ventilation solutions for maximum savings and easy integration.

### Energy recovery ventilation.

Panasonic energy recovery ventilations (ERV) help to improve your comfort and energy-saving plan. Introducing the ERV with DX coil - HRPT Series, specifically designed for commercial applications or collective residential buildings, offering highly efficient heat recovery.

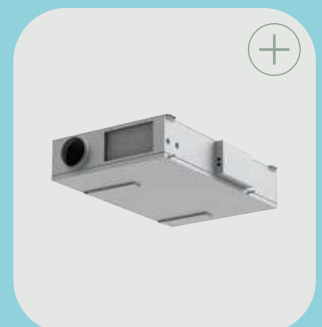

## CONTROL AND CONNECTIVITY



From the individual remote controller for the residential single units up to the newest technology capable of controlling your building anywhere in the world.

### Panasonic AC Smart Cloud.

Panasonic AC Smart Cloud provides building mapping, remote monitoring, error notification and schedule setting for site managers. Panasonic AC Service Cloud help maintenance companies to manage multiple sites with remote checking and advance failure prediction functions.



## CHILLERS AND HEAT PUMPS, AND WATER SOURCE HEAT PUMPS



Panasonic solutions to suit a variety of commercial and industrial applications. Our systems provide the optimal performance in any climatic condition.

### ECOi-W AQUA-G BLUE R290. A revolutionary solution.

ECOi-W AQUA-G BLUE powered by R290, a natural refrigerant. It delivers both sustainability and efficiency in one innovative package.



## FAN COIL UNITS



Stylish, premium units for residential projects with a sophisticated, compact design and customizable, flexible units for commercial applications.

### New fan coil wall.

The new fan coil wall with modern, stylish design comes with the nanoe™ X technology (Generator Mark 3) for improved indoor air quality. It is ideal for both residential and commercial applications.



## ROOFTOPS



Rooftop units provide air-based cooling and heating for commercial buildings to ensure thermal comfort and proper indoor air quality (IAQ) through ventilation.

### Rooftops.

With Rooftop units, you get a complete compact and mono-bloc solution to heat and cool large buildings such as shopping centers, industries or airports that need high capacities. It is an easy to install, space saving solution, directly on the roof or close to a building.



## REFRIGERATION



Panasonic CO<sub>2</sub> condensing units - CR Series with natural refrigerant. Natural refrigerant solution for showcases and cold rooms. Reliable quality - made in Japan.

### CR Series 20 HP MT/LT model.

The CR Series now includes a 20 HP medium/low temperature model, a highly efficient multi-compressor solution. The smaller footprint of the unit and the maximum piping length of 100 m allow for flexible installation in tight refrigeration projects.



## DIMENSIONS



## WIRING DIAGRAMS



Quality Management System Certificate



ISO 9001: 2015  
Panasonic Appliances Air-Conditioning  
Malaysia, Sdn.Bhd.  
Cert. No.: QMS 00413



GB/T 19001-2016/ISO 9001: 2015  
Panasonic Appliances Air-Conditioning  
(GuangZhou) Co., Ltd.  
Registration Number: 01218Q30835RBL

Environmental Management System Certificate



ISO 14001: 2015  
Panasonic Appliances Air-Conditioning  
Malaysia Sdn.Bhd.  
Cert. No.: EMS 00109



GB/T 24001-2016/ISO 14001: 2015  
Panasonic Appliances Air-Conditioning  
(GuangZhou) Co., Ltd.  
Registration Number: 02118E10944R7M

# Panasonic environmental vision 2050

To achieve “a better life” and “a sustainable global environment,” Panasonic will work towards creation and more efficient utilisation of energy which exceeds the amount of energy used, aiming for a society with clean energy and a more comfortable lifestyle.

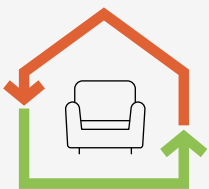

## Energy used < Energy created

One initiative in the Panasonic environmental vision 2050 is offering products with greater energy efficiency. In 2018, we celebrated the 60th anniversary of our Heating & Cooling Solutions business. Our expertise gained over the years has helped us launch a range of products that contribute to a more carbon-free society.

### Current status of energy used and energy created

Energy used by Panasonic business activities and products.



Clean energy created and / or made available by Panasonic products, etc.

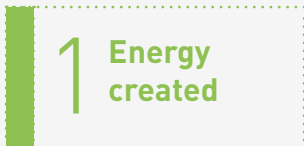

### Working to realise environmental vision 2050

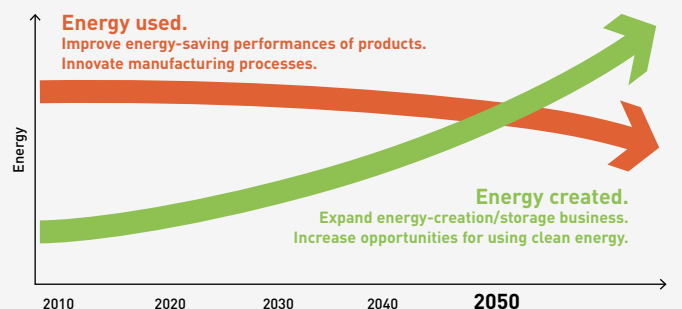

# Heating and cooling solution with R290 natural refrigerant

Following Panasonic's Environmental Vision 2050, Panasonic presents an advanced, high-energy-saving heating and cooling solution utilising the natural refrigerant R290 with a low GWP of 0,02. These solutions not only minimise environmental impact but also enhance energy efficiency and comfort in heating and cooling.



**Aquarea M and L Series (5 - 300 kW\*).**

**ECOi-W AQUA-G BLUE (50 - 640 kW\*).**

The R290 refrigerant technology has been integrated across a wide range of heating and cooling solutions, meeting both residential and commercial needs. These solutions are available in capacities from 5 to 640 kW\*.

\* Cascade control required.

## Contributing to the decarbonisation of society.

Natural refrigerant R290 has low Global Warming Potential (GWP) of just 0,02\* (R32:675 and R410A: 2088), helping reduce CO<sub>2</sub> emissions and environmental impact. It's a green alternative solution for any residential and commercial projects and delivers outstanding performance, aligning with Panasonic vision of a carbon-free society and our GREEN IMPACT plan.

\* GWP 0,02 (AR6). Based on the Sixth Assessment Report adopted by the Intergovernmental Panel on Climate Change (IPCC).

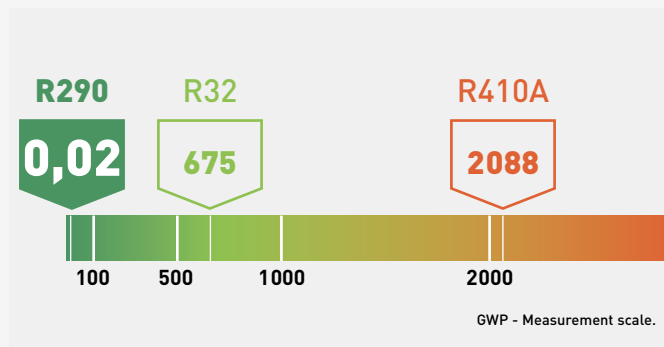

## Industry leading Panasonic technology with natural refrigerant R290.

Panasonic's heating and cooling solution with R290 natural refrigerant, is not only a 'green solution' but also delivers outstanding performance to meet the demands of the most challenging projects. An ideal solution with high performance and quality, coupled with minimized environmental impact, making it a worthwhile investment for the future.

 <p><b>High water outlet temperature up to 75 °C.</b></p>	 <p><b>Quiet operation.</b></p>	 <p><b>High quality, made in Europe.</b></p>	 <p><b>Range from 5 to 80 kW, boost capacity up to 640 kW with a cascade control.</b></p>
--	------------------------------------	---	--

\* The specification varies depending on the series. Please check the detailed information on each product page.

## Case studies

Panasonic, your partner with the knowledge and experience to realize your projects, both at the national and international levels, implementing them on time and within budget. Solutions that not only cut costs but are also efficient, environmentally friendly, user-friendly, reliable, and innovative.



**Arctic Treehouse Hotel.**  
Rovaniemi, Lapland, Finland.  
**Power Heat Multi.**

The multi system for extremely cold weather is installed in the cosy Arctic Glasshouse to ensure comfort and air quality in the lounge and 2 bedrooms of the cabin on the coldest days.



**Single family house.**  
Höllviken, Sweden.  
**Aquarea with natural refrigerant R290.**

Aquarea L Series with R290 replaced an old heating system, providing comfort in cold weather and reducing energy costs. Being connected to the Aquarea Service Cloud, the heat pump can be monitored remotely by a service company.



**Public school.**  
Białystok, Poland.  
**ECOi-W AQUA-G BLUE.**

Panasonic ECOi-W series air cooled heat pumps 80 kW with sustainable R290 refrigerant were installed in a cascade system at an elementary school to provide energy-efficient heating.



**Weinbuch Butcher's Shop.**  
Shop - Restaurant.  
Öpfingen, Germany.  
**VRF, Domestic and Refrigeration.**

The entire meat production cold rooms are equipped with Panasonic CO<sub>2</sub> condensing units, and ECOi EX systems for cooling and a part of the heating for areas such as the Bistro, production facility, and Drive-in stations.

As a global company, Panasonic offers European coverage for support, providing financial, logistical, and technical resources to develop comprehensive and wide-ranging solutions at both national and international levels. This ensures timely and budget-conscious implementation.



Belfast Grand Opera House.  
Public building.  
Belfast, United Kingdom.  
**PACi, VRF and Control.**



Varna Wave Building.  
Residential building.  
Varna, Bulgaria.  
**Aquarea and Aquarea Smart Cloud.**



Passivhouse in Miño.  
Residential passive house.  
Miño, Spain.  
**Aquarea.**



Flumen Plus.  
Residential passive house building.  
Zaragoza, Spain.  
**PACi.**



Hotel Moxy Oriente.  
Hotel.  
Lisboa, Portugal.  
**PACi, VRF and Control.**



Gutenfels.  
Hotel.  
Kaub, Germany.  
**Aquarea and Aquarea Smart Cloud.**



Maison Tirel Guerin.  
Hotel- Restaurant.  
Saint Méloir-des- Ondes, France.  
**Mini ECOi.**



Crosslight House.  
Residential building.  
Mulazzano, Italy.  
**PACi and nanoe™ X.**



Gurewicz Spa Resort.  
Hotel- Restaurant - Spa.  
Otwock, Poland.  
**PACi, VRF and Control.**



Nobelhorst.  
Residential building.  
Almere, Nederland.  
**Aquarea.**



Amandiers.  
Sports complex.  
Carrierre sur Seine, France.  
**ECOi-W.**



Hungarian Cédrus Liget. A complex facility including apartments, offices and commercial units.  
Szeged, Hungary.  
**ECOi-W, ECOi and ERV.**



Stemcell Technologies.  
Global biotechnology company.  
Saint-Egrève, France.  
**Refrigeration.**



South Lodge.  
Luxury 5 star Hotel and Spa.  
West Sussex, United Kingdom.  
**PACi, Control and nanoe™ X.**



Pervalkos Jūra.  
Residential.  
Pervalka, Lithuania.  
**Aquarea.**



Thon Hotel Harstad.  
Hotel.  
Harstad, Norway.  
**PACi, VRF and Refrigeration.**

# A desire to create things of value

“Recognising our responsibilities as industrialists, we will devote ourselves to the progress and development of society and the well-being of people through our business activities, thereby enhancing the quality of life throughout the world.”

Panasonic Corporation’s Basic Management Objective, formulated in 1929 by the company’s founder, Konosuke Matsushita.



**1958**  
First room air conditioner launched for domestic installation.

**1975**  
Panasonic becomes one of the first Japanese air conditioner manufacturers in Europe.

**1985**  
Introduces first GHP (gas heat pump) VRF air conditioner.

**2008**  
World’s first air conditioner equipped with nanoe™.

**2015**  
CO<sub>2</sub> condensing units in Europe. The ideal solution for supermarkets, shops and gas stations.

**1971**  
Starts production of absorption chillers.

**1982**  
Panasonic launches the first highly efficient air to water heat pump in Japan.

**1989**  
Introduces world’s first simultaneous 3-Pipe heating / cooling VRF System.

**2010**  
New Aquarea. Panasonic introduces Aquarea, an innovative new, low-energy system in Europe.

**2012**  
New Panasonic GHP units. The gas-driven VRF Systems are ideal for projects where power restrictions apply.





# Vitalize the future with air

These are times of exceptional challenge.

If the world is to move forward confidently, it must overcome the serious threats of the new global pandemics and the degrading of the environment. It must find ways large and small to reduce the stresses that affect people's health and the stability of their communities.

At Panasonic, we're utilizing the power of air to create positive change.

Air that benefits body and mind.

Air that energizes the places where people gather to work and play.

Air that reduces our burden on the Earth.

With more than a century of research and expertise to guide us, we're using air to open a more hopeful and vital future for all.



**2016**  
New VRF Systems ECOi EX with extraordinary energy saving performance.

**2019**  
Panasonic introduces a new Chiller Series which is named as ECOi-W.

**2021**  
Mini VRF R32 up to 10 HP. Outstanding efficiency in a compact body.  
— A2W maintenance.

**2023**  
Aquarea Heat Pumps with natural refrigerant R290.  
— New European factories for hydronics products.

**2025**  
Aquarea Heat Pumps + tado°, the integrated solution for maximum energy savings and comfort.

**2018**  
The first Hybrid System with VRF and GHP in Europe.  
— Opening heat pump production line in Czech Republic, Europe.

**2020**  
nanoe™ X, technology with the benefits of hydroxyl radicals. Improving protection 24/7. Built-in nanoe™ X technology expanded to commercial solutions.

**2022**  
ECOi-W R32, the new range of sustainable chiller solutions to suit a variety of commercial and industrial applications.

**2024**  
ECOi-W AQUA-G BLUE. Air to water reversible heat pumps. Powered by R290, a natural refrigerant.  
— Collaboration with key partners.

Looking ahead



# Panasonic HVAC&R solution map

HYDRONIC



## AQUAREA. Air to water heat pumps.

Peripherals: Fan coil units / Water Loop heat pumps / DHW Heat Pump / Hot water tanks / Smart solutions and connectivity / Room control.

5 kW - 30 kW (up to 300 kW with a cascade controller)



MULTI-FAMILY HOUSES



SINGLE HOUSES



LIGHT COMMERCIAL

2 kW - 7,1 kW



## ETHEREA & More. Domestic air to air heat pumps.

Peripherals: Wi-Fi control and connectivity.



2,5 kW - 25 kW



## PACi NX. Light commercial air to air heat pumps.

Peripherals: Air to air indoor units / Low temperature configuration / Water Heat Exchanger.



DIRECT EXPANSION

VENTILATION

90 m<sup>3</sup>/h - 455 m<sup>3</sup>/h



## Residential ventilation.

Peripherals: Air distribution solutions / Wi-Fi control and connectivity.



Panasonic offers a wide range of HVAC&R solutions for various applications, from residential and multi-family houses to commercial buildings and specialised applications such as data centres and refrigeration. Each range delivers highly efficient and reliable performance, meeting the needs of every application.



**ECOi-W. Commercial chiller & heat pump.**

Peripherals: Fan coil units / Water source heat pumps / Connectivity.

20 kW - 1550 kW



**TECNAIR\*. Close Control.**

10 kW - 500 kW



COMMERCIAL / INDUSTRIAL

40 kW - 210 kW



**ECOi-RT. Commercial Rooftop.**



4 HP - 80 HP



**ECOi, ECO G. Commercial VRF.**

Peripherals: Air to air indoor units / Water Heat Exchanger / Connectivity.



150 m<sup>3</sup>/h - 2000 m<sup>3</sup>/h



**Commercial ventilation.**

Energy recovery ventilation with DX / Air curtains / AHU connection kit.



DATA CENTER



REFRIGERATION

2 HP - 20 HP



**CR Series. Light commercial refrigeration.**



HYDRONIC

DIRECT EXPANSION

VENTILATION

# Bringing nature's balance indoors



nanoe™ X, technology with the benefits of hydroxyl radicals.



In today's health-conscious world, we care about taking exercise, we care about what we eat and what we touch, we also care about what we breathe – and technology exists to bring good outdoor air, indoors.

Cumulative global shipments of nanoe™ devices exceed 100 million units\*

\* From July 2024, the results apply to all other products with nanoe™ X devices, including heating and cooling.



Abundant in nature, hydroxyl radicals (also known as OH radicals) have the capacity to inhibit pollutants, viruses, and bacteria to clean and deodorise. nanoe™ X technology can bring these incredible benefits indoors so that hard surfaces, soft furnishings, and the indoor environment can be a cleaner and more pleasant place to be, whether at home, work, or visiting hotels, shops and restaurants etc.

## A naturally occurring process

Hydroxyl radicals are unstable molecules looking to react with other elements like hydrogen, capturing it. Thanks to this reaction, hydroxyl radicals have the potential to inhibit the growth of pollutants such as bacteria, viruses, moulds, and odours, breaking them down and neutralising the unpleasant effects. This naturally occurring process has major benefits to improve indoor environments.



Hydroxyl radicals in nature.



Hydroxyl radicals contained in water.

By creating hydroxyl radicals contained in water, nanoe™ X technology significantly boosts their effectiveness, increasing hydroxyl radicals lifetime from less than a second in nature, to more than 600 seconds – 10 minutes so that nanoe™ X can spread easily around the room.

Panasonic's nanoe™ X technology takes this a step further and brings nature's detergent – hydroxyl radicals – indoors to help create an ideal environment

Thanks to the nanoe™ X properties, several types of pollutants can be inhibited such as certain types of bacteria, viruses, mould, allergens, pollen and certain hazardous substances.



1 | nanoe™ X reliably reaches pollutants.



2 | Hydroxyl radicals denature pollutants' proteins.



3 | Pollutants activity is inhibited.

## The well-being benefits of nature are well known – but do you know the power of hydroxyl radicals?

### What is unique about nanoe™ X?

Hydroxyl radicals inhibit pollutants, certain types of viruses, and bacteria to clean and deodorise. Thanks to this advanced technology, even tightly woven fabrics can be treated using this solution, meaning that curtains, blinds, carpets and furniture can all benefit from this technology to inhibit hazardous substances – including on hard surfaces and, of course, the air that we breathe.



#### Effective on fabrics and surfaces.

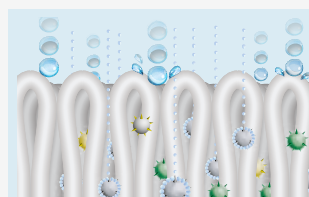

1 | At one billionth of a metre, nanoe™ X is much smaller than steam and can deeply penetrate cloth fabrics to deodorise.

#### Longer lifespan.



2 | Contained in tiny water particles, nanoe™ X has a long lifespan, which is about 600 seconds, to spread easily around the room.

#### Huge quantity.



3 | nanoe X Generator Mark 3 produces 48 trillion hydroxyl radicals per second. Greater amounts of hydroxyl radicals contained in nanoe™ X lead to higher performance on inhibition of pollutants.

#### Maintenance-free.



The image shows nanoe X Generator Mark 3.

4 | No service and maintenance required. nanoe™ X is a filter free solution that does not require maintenance, as its atomisation electrode is enveloped with water during its generation process and it is made with Titanium.

### 7 effects of nanoe™ X – Panasonic unique technology

#### Deodorises



Odours

#### Capacity to inhibit 5 types of pollutants



Bacteria and viruses



Mould



Allergens



Pollen



Hazardous substances



Skin and hair

\* Refer to <https://aircon.panasonic.eu> for more details and validation data.

### First nanoe™ device was developed by Panasonic in 2003

Introducing nanoe X Generator Mark 3, the latest of the continuously evolving nanoe™ X technology, it has the largest amount of hydroxyl radical in the history of nanoe™ (48 trillion hydroxyl radical per second, 100 times the traditional nanoe™). The increased number of hydroxyl radical, which are the key to nanoe™ effectiveness, means you can expect an even higher level of performance.

#### Generator: nanoe™

2003

480 billion hydroxyl radicals/sec

#### Ion particle structure

Hydroxyl radicals

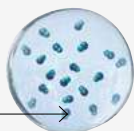

#### Generator: nanoe™ X

Mark 1 - 2016

4,8 trillion hydroxyl radicals/sec

10x times

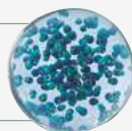

Mark 2 - 2019

9,6 trillion hydroxyl radicals/sec

20x times

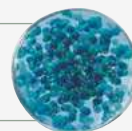

Mark 3 - 2022

48 trillion hydroxyl radicals/sec

100x times

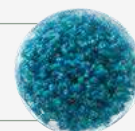

nanoe™ X, internationally-validated technology in testing facilities.

The effectiveness of nanoe™ X technology has been tested by 3rd party laboratories in Germany, France, Denmark, Japan and China.

The nanoe™ X performance varies depending on the room size, environment and usage and it may take several hours to reach the full effect. nanoe™ X is not medical device, local regulations on building design and sanitary recommendations must be followed. Test results conducted under controlled laboratory conditions. Performance of nanoe™ X might differ in real life environment.

**Panasonic heat pump with nanoe™ X technology verified against SARS-CoV-2**

Virus SARS-CoV-2: 91,4% inhibited. Test conducted by TEXCELL (France), using a gauze saturated with SARS-CoV-2 virus solution exposed to Panasonic heat pump with nanoe™ X in a space of 6,7 m³ over 8 hours. Test report: 1140-01 C3. Performance of nanoe™ X might differ in real life environment.

	Tested contents	Generator	Result	Capacity	Time	Testing organisation	Report No.	
Airborne	Virus	Influenza (H1N1)	98,3% inhibited	30 m³	1,5 h	China Electronic Product Reliability and Environmental Testing Research Institute	J2003WT8888-00889	
		Bacteriophage ΦX174	99,2% inhibited	Approx. 25 m³	6 h	Kitasato Research Center for Environmental Science	24_0300_1	
	Bacteria	Staphylococcus aureus	99,7% inhibited	Approx. 25 m³	4 h	Kitasato Research Center for Environmental Science	24_0301_1	
Adhering	Virus	SARS-CoV-2	91,4% inhibited	6,7 m³	8 h	Texcell (France)	1140-01 C3	
		SARS-CoV-2	99,9% inhibited	45 L	2 h	Texcell (France)	1140-01 A1	
		Bacteriophage ΦX174	99,8% inhibited	Approx. 25 m³	8 h	Japan Food Research Laboratories	13001265005-01	
		Xenotropic murine leukemia virus	99,999% inhibited	45 L	6 h	Charles River Biopharmaceutical Services GmbH	—	
		Coxsackie virus (CA16)	99,9% inhibited	30 m³	4 h	China Electronic Product Reliability and Environmental Testing Research Institute	J2002WT8888-00439	
		Bacteriophage	Mark 3	98,81% inhibited	Approx. 139,3 m³	4 h	SGS Inc	SHES210901902584
	Bacteria	Staphylococcus aureus	Mark 1	99,9% inhibited	20 m³	8 h	Danish Technological Institute	868988
		Pollen	Cedar pollen	Mark 3	99% inhibited	Approx. 24 m³	12 h	Panasonic Product Analysis Center
	Ambrosia pollen		Mark 1	99,4% inhibited	20 m³	8 h	Danish Technological Institute	868988
	Odours	Cigarette smoke odour	Mark 1	Odour intensity reduced by 2,4 levels	Approx. 23 m³	0,2 h	Panasonic Product Analysis Center	4AA33-160615-N04
			Mark 3	Odour intensity reduced 1,7 levels	Approx. 139,3 m³	0,5 h	SGS Inc	SHES210901902478

Licensed in VDI 6022

Certification of a HVAC system under VDI 6022 guarantees that the system fulfills the market's strictest hygiene requirements.



**VDI 6022 – Part 5 <sup>1)</sup> Certification.**

**Avoidance of allergenic exposure.**

Inhibits a wide range of harmful bacteria, viruses, mould, pollen and allergens.



**VDI 6022 – Part 1 <sup>1)</sup> & 1.1 <sup>2)</sup> Certification.**

**Ventilation and indoor-air quality.**

Panasonic nanoe™ X technology improving indoor air quality.

1) Certification mark only valid for nanoe X Generator Mark 3. 2) Certification mark only valid for nanoe X Generator Mark 2 and Mark 3.

Effectiveness in large space with Generator Mark 3

**Inhibits virus.**

An air conditioner equipped with nanoe X Generator Mark 3 inhibits activity of adhered virus (Bacteriophage) by 98,81% in 4 hours <sup>1)</sup>.

Test ambient.

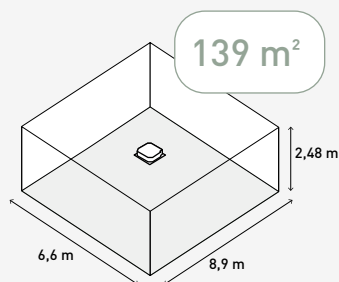

Test result (bacteriophage).

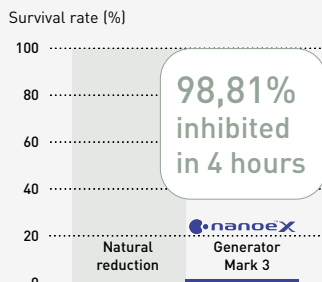

**Inhibits pollen.**

The result of nanoe X Generator Mark 3. Inhibits pollen in 1/4 the time of nanoe X Generator Mark 2 <sup>2)</sup>.

Comparison of time required to inhibit 99% of cedar pollen <sup>3)</sup>.

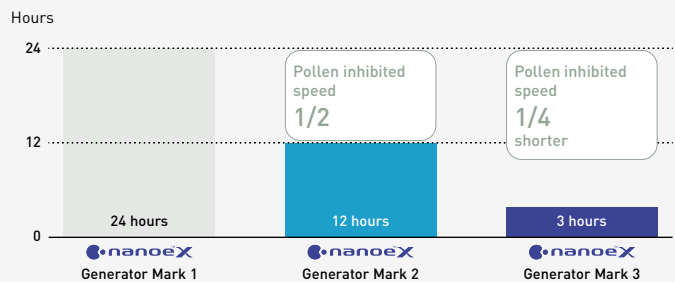

1) Testing organisation: SGS Inc / Test subject: Adhered Bacteriophage / Test volume: Approx. 139 m³ large space (6,6 x 8,9 x 2,48 m). Test result: Inhibited 98,81% in 4 hours. Test report no.: SHES210901902583.  
 2) Effect after 3 hours in a test space of approx. 24 m³. The figures are not the results of testing in an actual operating space. 3) nanoe X Generator Mark 1: [Testing organisation] Panasonic Product Analysis Center [Test method] ELISA method of measuring allergens adhering to fabric in a test room (approx. 24 m³) [Method of inhibition] Release of nanoe™ [Target] Adhered allergen (cedar pollen) [Test Result] Inhibition of 99% or more in 24 hours (4AA33-151001-F01). nanoe X Generator Mark 2: [Testing organisation] Panasonic Product Analysis Center, [Test method] ELISA method of measuring allergens adhering to fabric in a test room (approx. 24 m³) [Method of inhibition] Release of nanoe™ [Target] Adhered allergen (cedar pollen) [Test Result] Inhibition of 99% or more in 12 hours confirmed (L19YA009). nanoe X Generator Mark 3: [Testing organisation] Panasonic Product Analysis Center [Test method] ELISA method of measuring allergens adhering to fabric in a test room (approx. 24 m³) [Method of inhibition] Release of nanoe™ [Target] Adhered allergen (cedar pollen) [Test Result] Inhibition of 99% or more in 3 hours (H21YA017-1).

## Where is nanoe™ X technology used?

Since 2003, nanoe™ has become a part of people's lives in Japan and other regions.

Such technology can be found in diverse applications for cleaning air and surfaces, inside trains, elevators, cars, home appliances and personal beauty ... as well as in air conditioning.

Panasonic Heating & Cooling Solutions is incorporating nanoe™ technology in a wide range of equipment for residential applications as well as for commercial spaces and, it is a solution that does not require filters or maintenance and can work independently from heating or cooling.



Home



Shop



Gym



Hotel



Office



Clinic



Restaurant



Hospital

It has been adopted in people's homes as well as in public facilities where improved air quality is desired, such as offices, hospitals, healthcare centres and hotels etc.

## nanoe™ X: improving protection 24/7



## Panasonic Heating & Cooling Solutions is incorporating nanoe™ technology in a wide range of equipment

### Home.

Built-in nanoe X Generator Mark 3.



**Wall-mounted Ethera.**  
CS-XZ\*\*ZKEW-H.  
4 capacities: 2,0 - 4,2 kW.  
CS-XZ\*\*ZKEW.  
4 capacities: 2,0 - 5,0 kW.  
CS-(M)Z\*\*ZKE(W).  
7 capacities: 1,6 - 7,1 kW.

Built-in nanoe X Generator Mark 2.



**Aquaera EcoFlex ducted unit.**  
S-71WF3E.

Built-in nanoe X Generator Mark 1.



**Wall-mounted TZ super-compact.**  
CS-(M)TZ\*\*ZKE(W).  
8 capacities: 1,6 - 7,1 kW.



**Floor console.**  
CS-Z\*\*UFEAW.  
4 capacities: 2,0 - 5,0 kW.

Built-in nanoe™.



**Wall-mounted VZ Heatcharge.**  
CS-VZ\*\*SKE.  
2 capacities: 2,5 - 3,5 kW.

### Commercial.

PACi NX. Built-in nanoe X Generator Mark 1.



**4 way 90x90 cassette - PU3.**  
S-\*\*\*\*PU3E.  
7 capacities: 3,6 - 14,0 kW.

PACi NX. Built-in nanoe X Generator Mark 2.



**Wall-mounted - PK4.**  
S-\*\*\*\*PK4E.  
5 capacities: 3,6 - 10,0 kW.



**4 way 60x60 cassette - PY3.**  
S-\*\*\*PY3E.  
4 capacities: 2,5 - 6,0 kW.



**Ceiling - PT3.**  
S-\*\*\*\*PT3E.  
7 capacities: 3,6 - 14,0 kW.



**Adaptive ducted unit - PF3.**  
S-\*\*\*\*PF3E.  
7 capacities: 3,6 - 14,0 kW.



**High static pressure hide-away.**  
S-\*\*\*PE4E.  
2 capacities: 20,0 and 25,0 kW.

Fan coils units. Built-in nanoe X Generator Mark 3.



**Fan coil wall - FK1.**  
S-\*\*\*FK1E.  
6 capacities: 1,9 - 5,23 kW.

VRF. Built-in nanoe X Generator Mark 3.



**U2 type 4 way 90x90 cassette.**  
S-\*\*\*\*MU2E5C.  
11 capacities: 2,2 - 16,0 kW.



**Y3 type 4 way 60x60 cassette.**  
S-\*\*\*MY3EB.  
6 capacities: 1,5 - 5,6 kW.



**F3 type adaptive duct.**  
S-\*\*\*MF3E5D.  
12 capacities: 1,5 - 16,0 kW.



**M2 type hide-away.**  
S-\*\*\*MM2EB.  
7 capacities: 1,0 - 5,6 kW.



**K3 type wall-mounted.**  
S-\*\*\*MK3E.  
8 capacities: 1,5 - 10,6 kW.

VRF. Built-in nanoe X Generator Mark 1.



**G1 type floor console.**  
S-\*\*\*MG1E5N.  
5 capacities: 2,2 - 5,6 kW.

Ventilation. Built-in nanoe X Generator Mark 1.



**Ceiling mounted air-e.**  
FV-15CSD1G.  
1 capacity.

## nanoe™ X: improving protection 24/7

## 100% Panasonic, the DNA of Japanese craftsmanship

Applying advanced technologies that truly make life better, we live by an unparalleled commitment to product quality.

Panasonic is building on the Japanese tradition of uncompromising quality control worldwide, developing and manufacturing fine products and delivering them to customers everywhere.





At Panasonic, we believe that the best air conditioner is one that works quietly and effectively in the background whilst minimising its impact on the environment.

People who use our products can look forward to long years of high-quality performance without the need for constant service. As part of our rigorous design and development process, Panasonic air conditioners undergo a variety of stringent tests to ensure their effectiveness and long-term reliability. Tests for durability, waterproofing, shock resistance, and noise are conducted on component parts or on the finished products themselves.

As a result of all of these time consuming efforts, Panasonic air conditioners meet industrial standards and regulations in every country where they are sold.

### International Standard Quality

To uphold the company's reputation around the world, Panasonic strives continuously to offer quality with minimized environmental impact.



#### Reliable parts that meet or exceed industrial standards.

In every country where they are sold, Panasonic air conditioners comply with all required industrial standards and regulations. In addition, Panasonic conducts stringent testing to ensure the reliability of parts and materials. The strength of the resin material used in a propeller fan is confirmed by a tension test.



#### Compliance with RoHS / REACH substance restrictions.

Panasonic products and used materials strictly comply with chemical substance restrictions as defined by RoHS or REACH. During the development and production of parts, stringent inspections are conducted on over 100 materials to ensure that no hazardous substances are included.



#### Sophisticated production process.

Panasonic's air conditioner production lines employ state-of-the-art factory automation technologies to ensure products are manufactured with high attention to quality to meet expectations of reliability and trustworthiness.

### Durability

At Panasonic we know the importance of a long service life with minimal maintenance. That's why we subject our air conditioners to a wide range of stringent durability tests.



#### Long-term durability test.

To ensure durability and stable operation for many years, we conduct a long-term continuous operation test under conditions that are much more severe than actual operating conditions.



#### Compressor reliability test.

After the continuous operation test, we remove the compressor from a selected outdoor unit, disassemble it, and examine the internal mechanisms and parts for potential failure. This helps ensure reliable long-term performance under harsh conditions.



#### Waterproofing test.

The unit - which is subject to rain and wind - complies with IPX4 waterproof specifications. Contact sections on printed circuit boards are resin-potted to prevent adverse effects caused by exposure to water (an unlikely occurrence).

## A globally trusted air conditioning brand

Panasonic – leading the way in Heating and Cooling. With more than 50 years of experience, selling to more than 120 countries around the world, Panasonic is one of the leaders in the heating and cooling sector. With a diverse network of production and R&D facilities, Panasonic delivers innovative products incorporating cutting-edge technologies that set the standard for air conditioners worldwide.



From, for and by Europe.

**Panasonic R&D Centers in Europe.**

The European Research and Development Centers of Panasonic in Germany and Italy are focused on technology development for intelligent and environmentally friendly future solutions.

**Our European factories.**

In 2018, Panasonic began producing air to water heat pumps at its factory in Pilsen, Czech Republic. By 2023, production expanded to include air to water and water to water chillers and heat pumps, fan coils, water source heat pumps, and rooftops at Panasonic's factories in Italy and France. Additionally, Panasonic's new refrigeration factory in Poland further strengthens its commitment to the European market.

With a combination of highly skilled teams and advanced production automation, Panasonic is well-positioned to meet Europe's growing demand while maintaining exceptional quality standards.

**More than 40 years of experienced organization in Europe.**

At Panasonic, we know that the best is always yet to come. This is why our air conditioning and heat pump solutions are constantly upgraded. Panasonic is committed to offering our customers innovative products in the heating and cooling market across Europe, and has the ambition to not only meet but also exceed their requirements. Our Technology and Design teams anticipate the needs of tomorrow. We look to produce smaller, quieter, efficient solutions - with better technological features - that can reduce energy consumption while providing suitable temperature conditions for the user.

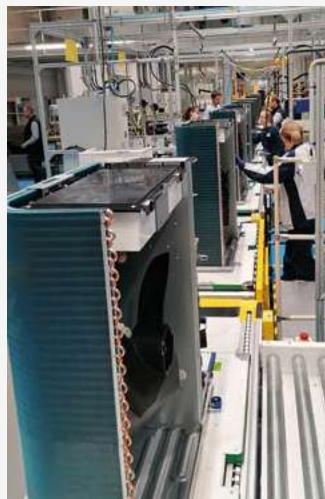

Czech



Italy



France



Poland

**39 Training Center in 22 countries in Europe**

**The Panasonic PRO Academy.**

Heating and Cooling business is changing rapidly, new technologies, new regulations, new solutions that require continuous update for professionals. Panasonic takes its responsibility to its distributors, specifiers and installers seriously and has developed a comprehensive training programme with 39 Training Center in 22 countries in Europe.

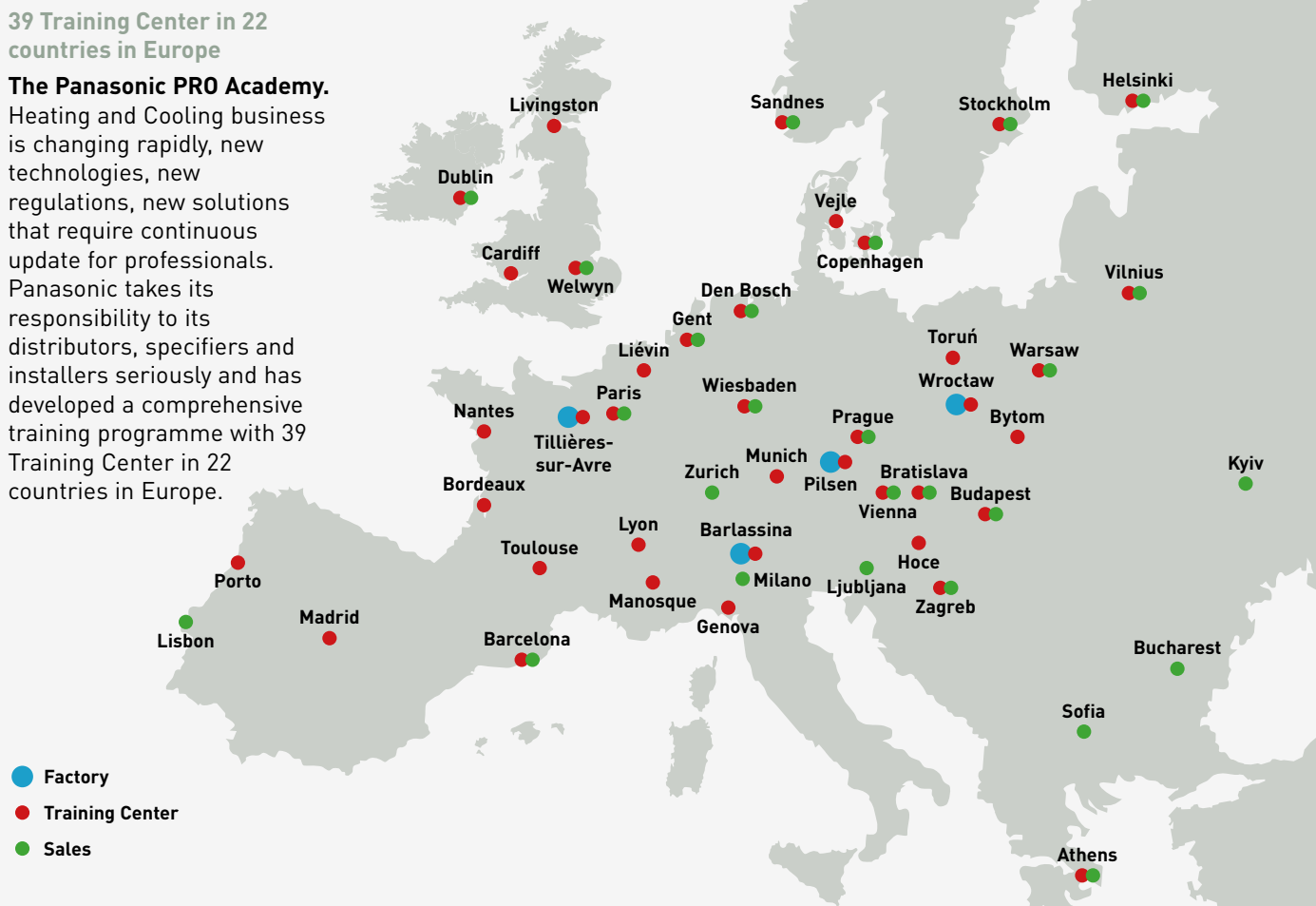

## PRO Club. The professional website of Panasonic

Panasonic has an impressive range of support services for designers, specifiers, engineers and distributors working in the heating and cooling markets.

Panasonic PRO Club ([www.panasonicproclub.com](http://www.panasonicproclub.com)) is the online tool which makes your life easier! You just have to register and a lot of functionalities are freely available to you, where ever you are, from your computer or smartphone!



- Print catalogues with your logo and contact details
- Access to the extensive library of professional design, selection and calculation tools (Aquarea Designer, VRF software, chiller selector, etc.)
- Get documents of conformity and all other documents you may need
- Download all the service manuals, end user manuals and installation manuals
- Download energy labels in PDF format using the energy label generators
- Download Revit and CAD files and specification texts
- Know what to do with error codes (error code search by error code or unit ref.)
- PRO Academy: register for training
- Download product images in high resolutions, advertisements, deco guidelines
- Get to know special offers and promotions
- Find out about the latest news first



Easy download Panasonic service documentation and brochures.



Customise leaflets with your logo and contact details. Save and print the PDF.



Energy label generator. Download Energy labels of any device in PDF format.



Error Code on your smartphone and your PC. Search by error code or model reference. Online version + downloadable version for offline use.

Panasonic PRO Club is fully compatible with tablet computer and smartphone.

Visit [www.panasonicproclub.com](http://www.panasonicproclub.com) or connect simply with your smartphone to the PRO Club using this QR.



Panasonic provides bespoke software and tools helping system designers, installers and dealers to very quickly select, design and size systems or create wiring or hydraulic diagrams at the push of a button.

### Aquarea Designer - online tool

With Panasonic's online tool, projects can be developed simply and easily. The newly developed tool is optimised to help HVAC professionals easily identify the most appropriate Aquarea air to water heat pump for a particular application.

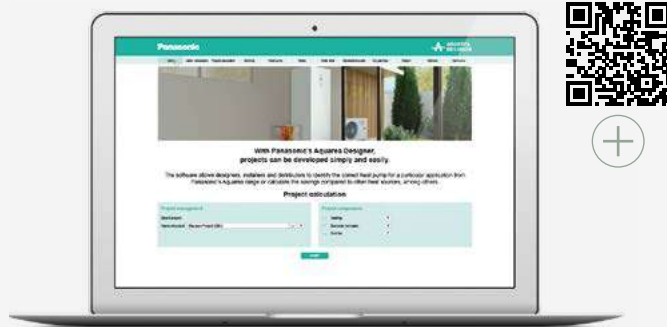

### Vent PRO

From selecting the right ventilation unit to planning the air distribution system and choosing the appropriate components, the Vent PRO guides you through every step to ensure the optimal solution for your project.

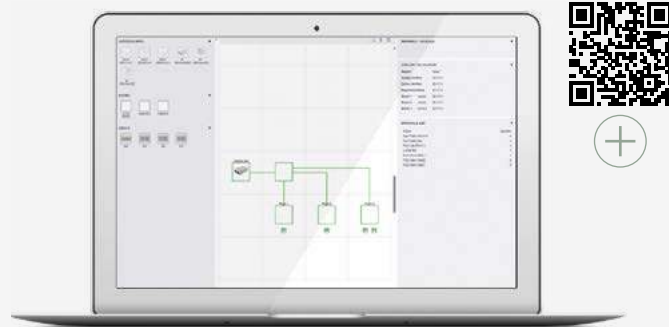

### Panasonic DX PRO Designer

The Panasonic DX PRO Designer will be rebuilt with an improved user experience. The software runs in the cloud and is always up to date with the latest products. An intuitive interface supports the most complicated designs, allows online sharing and project collaboration with multilingual support.



### AC SELECT

Use AC SELECT to choose and configure your hydronic solution. Panasonic online selection tool offers an easy and quick solution to specify all the hydronics ranges and rooftops at required conditions.

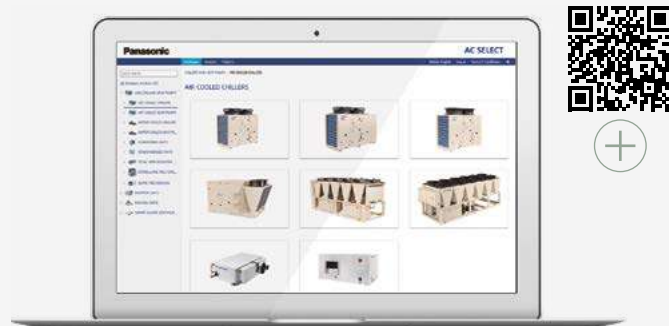

### Refrigeration designer

This simple design tool supports engineers, installers, and technicians to make a quick calculation for commercial refrigeration systems.

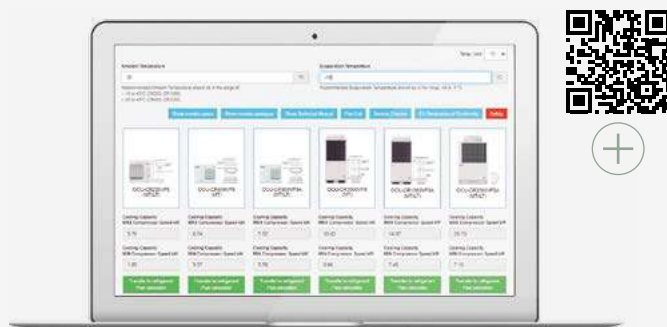

### OPEN BIM - BIM & AutoCAD Support

Panasonic offers a wide range of HVAC&R products with BIM (Building Information Modelling) objects in Revit format and AutoCAD files, providing comprehensive support for design offices, consultants, and installers in planning projects.

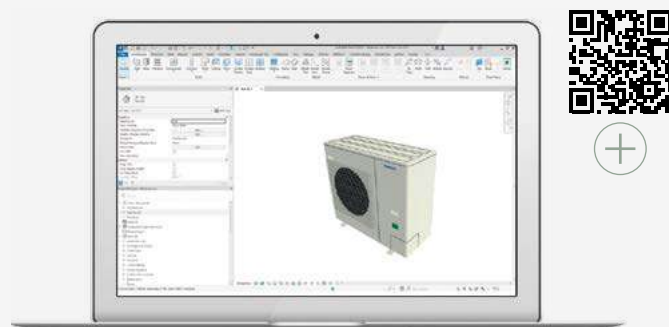

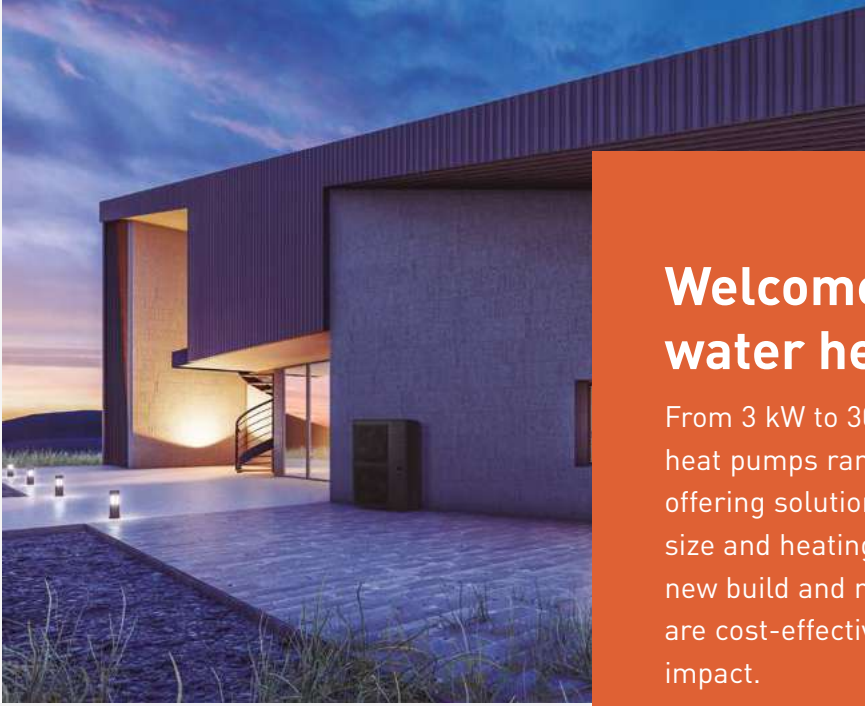

## Welcome to Aquarea air to water heat pumps

From 3 kW to 30 kW, Panasonic's Aquarea air to water heat pumps range is one of the widest on the market, offering solutions for most properties, whatever their size and heating and cooling demands. Suitable for new build and refurbishment projects, the solutions are cost-effective with minimised environmental impact.

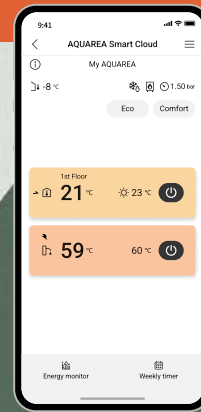



# AQUAREA

Highlighted features	→ 24
Aquarea – comprehensive heating solution by Panasonic	→ 26
Discover the Aquarea Heat Pump range	→ 28
Comfort heating and peace of mind with Aquarea solution	→ 30
At the forefront of heating innovation: Panasonic expands Aquarea series with natural refrigerant R290	→ 32
Aquarea T-CAP M Series, the latest generation of Aquarea Heat Pumps with R290	→ 34
Big Aquarea T-CAP M Series	→ 37
Big Aquarea for centralised heating and DHW installations	→ 38
Aquarea Loop	→ 40
Aquarea All in One Hydraulic M Series	→ 42
Aquarea K Series	→ 44
Aquarea EcoFlex	→ 46
Smart Solutions for Aquarea systems	→ 50
Aquarea Home App	→ 51
Panasonic Comfort Cloud App	→ 52
Aquarea Service Cloud	→ 53
Aquarea Heat Pumps + tado°	→ 54
Control for Aquarea Heat Pumps	→ 56
Connectivity	→ 57
Cascade manager	→ 58
P-Smart Edge for Aquarea Cascade Edge	→ 60
Nearly Zero Energy Buildings (nZEB)	→ 62
Aquarea and PV integration	→ 63
Aquarea design tools to make your life easier	→ 64
Validating efficiency and performance of Aquarea Heat Pumps	→ 75
Aquarea Hydraulic	→ 66
Aquarea Split	→ 68
Aquarea DHW Heat Pump	→ 68

## Aquarea High Performance

Hydraulic L Series · R290	→ 70
Hydraulic M Series · R290	→ 72
Mono-bloc J Series · R32	→ 74
All in One 185 L K Series · R32	→ 82
All in One 185 L K Series with Electrical Anode · R32	→ 83
All in One 260 L K Series / with Electrical Anode · R32	→ 84
All in One 185 L K Series 2 zones · R32	→ 85
All in One 185 L K Series · R32	→ 86
All in One 185 L K Series with Electrical Anode · R32	→ 87
All in One 260 L K Series · R32	→ 88
All in One 260 L K Series with Electrical Anode · R32	→ 89
Bi-bloc K Series · R32	→ 90

## Aquarea EcoFlex

→ 81

## Aquarea T-CAP

Hydraulic M Series · R290	→ 76
Mono-bloc J Series · R32	→ 80
All in One 185 L K Series · R32	→ 93
All in One 185 L K Series with Electrical Anode · R32	→ 94
All in One 260 L K Series · R32	→ 95
All in One 260 L K Series with Electrical Anode · R32	→ 96
Bi-bloc K Series · R32	→ 97
All in One H Series. Super Quiet outdoor unit · R410A	→ 98
Bi-bloc H Series. Super Quiet outdoor unit · R410A	→ 99

## Aquarea Air Smart fan coils

Fan coil floor standing	→ 104
Fan coil wall-mounted	→ 105
Fan coil ducted thin / ducted	→ 106
Fan coil ducted multi zone thin / ducted multi zone	→ 108
Fan coil comfort	→ 110
Fan coil wall – FK1	→ 114

## More options for your home

Aquarea Loop	→ 100
Sanitary tanks	→ 116
Heat recovery ventilation unit	→ 118
Aquarea Vent - Counter flow ventilation	→ 120
Aquarea DHW Heat Pumps	→ 122
Accessories and control	→ 124
Heating and cooling capacity tables	→ 140
Examples of installations	→ 149

## Highlighted features

Panasonic's Aquarea range of heat pumps deliver major energy savings thanks to its incredible efficiency even at -20 °C. The Panasonic Aquarea Heat Pumps are designed and produced by Panasonic and not by other companies.





Panasonic Aquarea Heat Pumps are part of a new generation of heating solutions that use a renewable, free energy source (air) to heat or cool the home and produce hot water by transferring heat rather than generating it.

The heat pump is one of the technologies listed on the International Energy Agency's (IEA) Blue Map, which aims to reduce CO<sub>2</sub> emissions to half of 2005 levels by 2050.

## Energy saving



### Natural refrigerant R290 with GWP 0,02.

Natural refrigerant R290 has low Global Warming Potential (GWP) of just 0,02, helping reduce CO<sub>2</sub> emissions and environmental impact.



### Refrigerant R32.

Our heat pumps containing R32 refrigerant show a drastic reduction in the value of Global Warming Potential (GWP).



### Better efficiency and value for medium temperature applications.

Energy efficiency class up to A++ in a scale from A+++ to D.



ErP 35°C

### Better efficiency and value for low temperature applications.

Energy efficiency class up to A+++ in a scale from A+++ to D.



DHW

### Better efficiency and value for domestic hot water.

Energy efficiency class up to A+ in a scale from A+ to F.



INVERTER+

### Inverter Plus system.

Inverter Plus system classification highlights Panasonic's highest performing systems.



AUTO SPEED

### A class water pump.

Aquarea are built-in with A class energy efficiency water pump. High efficiency circulating the water in the heating installation.



ErP

### ERP 2018.

Compliant following COMMISSION REGULATION (EU) No2016/2281.



EC MOTOR GREEN VENTILATION

### EC motor green ventilation.

Range of fan coils with improved efficiency and optional EC fan motors.

## High performance and indoor air quality



### Aquarea High Performance for low consumption houses.

From 3 to 16 kW. For a house with low temperature radiators or under-floor heating, our high performance Aquarea HP is a good solution. \* COP of 5,33 for 3 kW K series.



### Aquarea T-CAP for extremely low temperatures.

From 9 to 16 kW. It can work at outdoor temperatures as low as -28 °C and maintain the rated capacity down to -20 °C.



DHW

### DHW.

With Aquarea Heat Pumps, DHW can be produced efficiently, achieving high DHW COP of 3,6 with the L Series All in One indoor unit.



HEATING MODE

### Down to -20 °C in heating mode.

The heat pumps operate in heating mode with an outside temperature down to -20 °C.



WATER FILTER WITH MAGNET

### Water filter with magnet.

Easy access and fast clip technology for J Series onwards. Water filter only for H Series.



75°C OUTPUT WATER FLOW TEMPERATURE

### 75 °C output water.

Reaches water outlet temperature up to 75 °C for L and M Series.



65°C OUTPUT WATER FLOW TEMPERATURE

### 65 °C output water.

Reaches water outlet temperature up to 65 °C.



FLOW SENSOR

### Water flow sensor.

Included on H Series onwards.



5 YEARS COMPRESSOR WARRANTY

### 5 Years compressor warranty.

We guarantee the outdoor unit compressors in the entire range for five years.

## High connectivity



BOILER CONNECTION

### Renovation.

Our Aquarea Heat Pumps can be connected to an existing or new boiler for optimum comfort even at very low outdoor temperatures.



SOLAR KIT

### Solar kit.

For even greater efficiency, Aquarea Heat Pumps can be connected to photovoltaic solar panels with the optional PCB.



ADVANCED CONTROL

### Advanced control.

Remote controller with full dotted 3,5" wide back light screen. Menu with 17 available languages easy to use for installer and user. Included on H Series onwards.



INTERNET CONTROL

### Internet control.

The Panasonic Comfort Cloud App allows users to conveniently manage and monitor Panasonic residential heat pumps from a mobile device, anytime, anywhere.



BMS CONNECTIVITY

### BMS connectivity.

Aquarea Heat Pumps offer seamless integration into a Building Management System (BMS) using an optional gateway.



SG READY



APPROVED PRODUCT



MCS CERTIFICATE



CERTIFIED COMPANIES

Aquarea H and J Series heat pumps in combination with the optional PCB CZ-NSP4 hold the SG Ready Label (Smart Grid Ready Label), given by Bundesverband Wärmepumpe (German Heat Pump Association). This Label shows the real capacity of Aquarea to be connected in an intelligent grid control.

MCS Certificate number: MCS HP0086\*. Keymark: Check all our certified heat pumps on: [www.heatpumpkeymark.com](http://www.heatpumpkeymark.com). Passive House Institute: Certified models can be checked in <https://database.passivehouse.com>.

\* Not all products certified. As the certification process is on-going and the list of certified products constantly changing, please check for latest details on the official websites.

**Warning on quality of water and groundwater use:** This product is designed to comply with the European drinking water standard (EU) 2020/2184. The lifespan of the product is not guaranteed in the case of the use of groundwater, such as spring water or well water, the use of tap water when salt or other impurities are contained, nor in areas of acidic water quality. Maintenance and warranty costs related to these cases are the customer's responsibility.

# Aquarea – comprehensive heating solution by Panasonic

Welcome home. Experience comfort heating, energy savings and peace of mind with Aquarea heating solution.



**Introducing the Panasonic Aquarea – air source heat pump.**

Panasonic Aquarea Heat Pumps are designed to provide exceptional indoor comfort and energy efficiency. These advanced heat pumps offer a range of benefits, making them an ideal choice for heating, cooling and DHW production.

- High comfort all year-round
- High flexibility
- High energy savings in heating, cooling and DHW production
- Contributing to the decarbonisation of society

As much as 79% of the energy consumption of European homes comes from heating and producing DHW\*. That's why, compared to conventional boilers and electric heaters, highly efficient Panasonic air to water heat pump technology can make a significant difference. Moreover, by converting heat energy in the air into household warmth, this technology helps reduce CO<sub>2</sub> emissions and environmental impact.

\* <https://ec.europa.eu/eurostat>.

Up to 80%\* energy savings with Aquarea

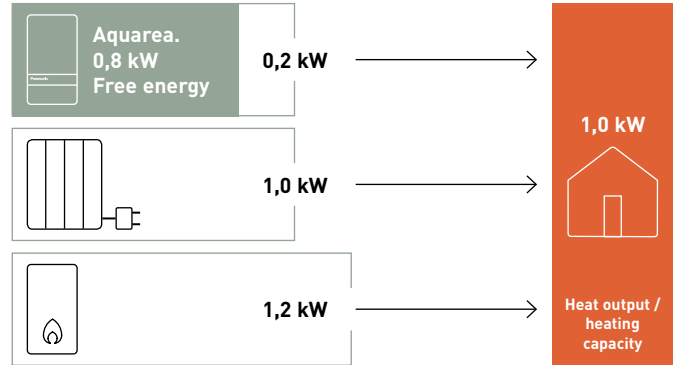

Power input / energy consumption power. \* At 35 °C flow temperature.

**Comfort heating and peace of mind with Aquarea solution.**

Panasonic extends its commitment to comfort and energy savings beyond heat pumps by offering a comprehensive range of solutions for indoor comfort.

**Fan coils for indoor climate control.**

**Residential ventilation for Indoor Air Quality with energy savings.**

**Room control and smart energy management services.**



**High efficiency tanks.**

**Aquarea Service Cloud for remote maintenance of the heat pump.**

**Aquarea Service +. Let us take care of your Aquarea Heat Pumps.**

# Discover the Aquarea Heat Pump range

Panasonic Aquarea provides the ideal solution for any project, enhancing the efficiency of homes and simplifying the installation process.

## Aquarea Hydraulic systems

The Aquarea Hydraulic system simplifies installation by requiring only water pipes between the outdoor unit and the interior of the building.

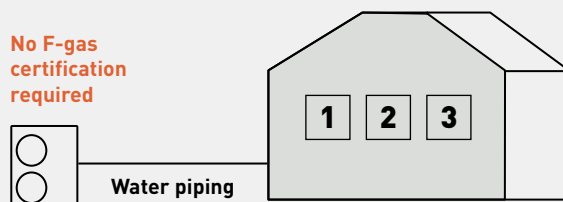

## Hydraulic indoor unit options

### 1 Stand-alone outdoor unit + optional DHW tank.

This hydraulic system without indoor unit offers high installation flexibility, ideal for retrofit projects.

### 2 All in One indoor unit.

The All in One unit combines the indoor unit and a DHW tank, simplifying installation and saving space.

### 3 Bi-bloc indoor unit + optional DHW.

This wall-mounted unit offers flexible installation with customizable tank sizes.

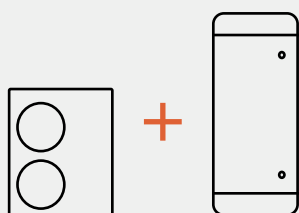

120 L - 185 L - 260 L



		5,0 kW	7,0 kW	9,0 kW	12,0 kW	16,0 kW	20,0 kW	25,0 kW	30,0 kW
Aquarea High Performance	1 ph	✓	✓	✓	✓	✓			
Aquarea T-CAP	1 ph			✓	✓				
	3 ph			✓	✓	✓	✓	✓	✓

## Aquarea DHW Heat Pumps

Using a compressor with natural refrigerant R290, Aquarea DHW Heat Pumps efficiently produce domestic hot water and significantly reduce energy consumption and CO<sub>2</sub> emissions compared to electric heaters and other traditional systems.



## Aquarea Split systems

The Aquarea split system features a separate outdoor unit and indoor unit connected by refrigerant pipes. It requires no antifreeze protection for outdoor piping, even during long periods of inactivity in cold climates.

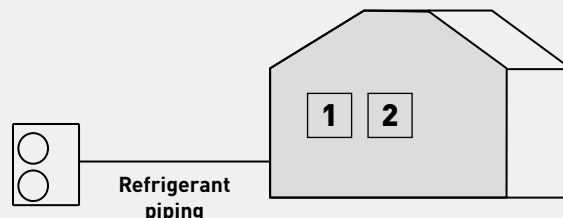

### Indoor unit options

#### 1 All in One indoor unit.

The All in One unit combines the indoor unit and a DHW tank, simplifying installation and saving space.

120 L - 185 L - 260 L



#### 2 Bi-bloc indoor unit + optional DHW.

This wall-mounted unit offers flexible installation with customizable tank sizes.

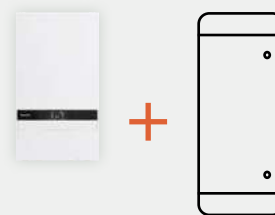

		5,0 kW	7,0 kW	9,0 kW	12,0 kW	16,0 kW
Aquarea High Performance	1 ph	✓	✓	✓	✓	✓
Aquarea T-CAP	1 ph			✓	✓	
	3 ph			✓	✓	✓

## Aquarea EcoFleX

Designed for new installations, the Aquarea EcoFleX heat pump combines an air-ducted unit with nanoe™ X technology and a hot water tank. It delivers hot water, heating, cooling, and cleaner air, all with outstanding efficiency, energy savings, and low CO<sub>2</sub> emissions.

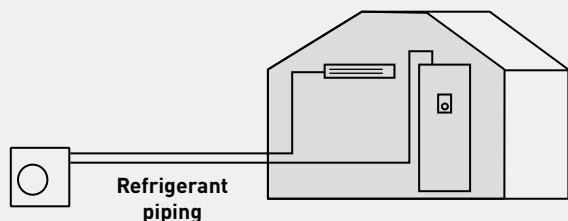

# Comfort heating and peace of mind with Aquarea solution

Panasonic extends its commitment to comfort and energy savings beyond heat pumps by offering a comprehensive range of solutions for indoor comfort.

## Aquarea Air Smart fan coils.

Stylish, compact fan coil units for high comfort and energy savings.

**Aquarea Air Smart fan coil floor standing.**  
Even narrower and thinner fan coils.



**Aquarea Air Smart fan coil wall-mounted.**  
The thinnest and most quietest in its class.



**Aquarea Air Smart fan coil ducted / ducted multi zone.**

Thin version with only 185 mm height.  
Integrated multi zone management (2-5 zones, with the multi zone line-up).

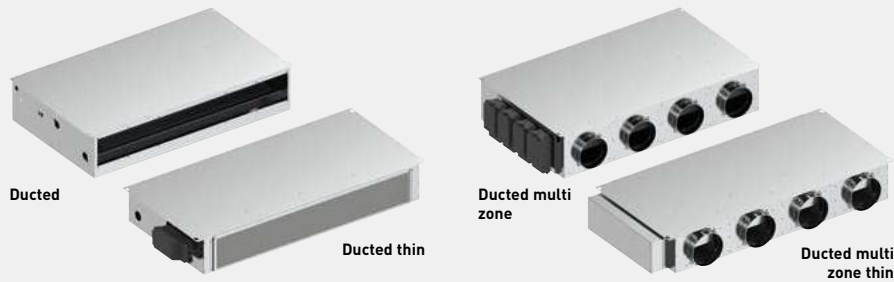

## Fan coil units.

A large range of fan coil units dedicated to commercial applications.

**NEW fan coil wall - FK1.**

Stylish design. nanoe™ X (Generator Mark 3).

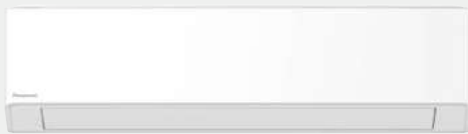

**nanoe™ X**

**Fan coil comfort AC/EC fan.**

Floor and ceiling units with high configuration flexibility.

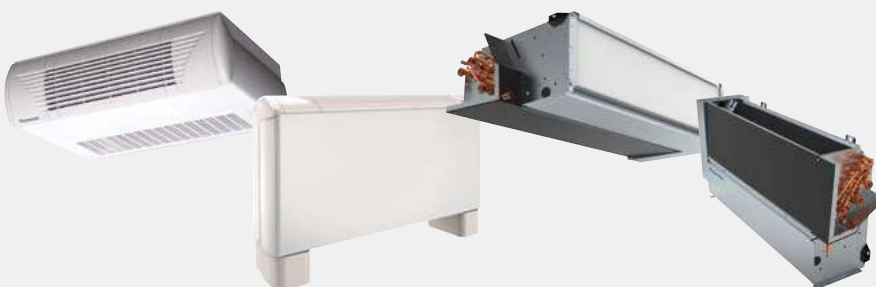

## Aquarea Loop, the water loop heat pump for multi-family buildings.

Efficiently replaces existing radiators in centralised heating systems.

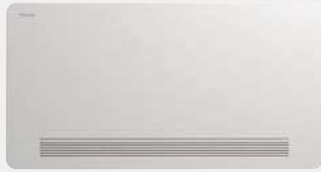

## Wide range of water tanks DHW tanks, buffer tanks and combo tanks available.



## Residential ventilation units.

**Aquarea Vent -Counter flow ventilation units.**  
Suitable for single family houses or apartments.  
High-efficiency sensible heat recovery.



**Heat recovery ventilation unit.**  
Designed for areas up to approximately 140 m<sup>2</sup>.  
High energy-efficiency rotary heat exchanger with EC - technology fans.



## tado° for room heating control and smart energy management services.

Unlocking maximum efficiency and savings - without sacrificing cosy temperatures at any time.

tado° smart heating customers save an average of 22% on their energy consumption.

\* Based on internal data averaged across all tado° customers, collected up to 11/2023.



## Cascade solutions.

Boost the capacity up to 300 kW by connecting the Aquarea Heat Pumps in cascade.



## Aquarea Service Cloud.

For remote maintenance of the Aquarea Heat Pump.



# At the forefront of heating innovation: Panasonic expands Aquarea series with natural refrigerant R290

Aquarea air to water heat pumps with R290 refrigerant range is a groundbreaking low energy system for heating, cooling and domestic hot water production that delivers outstanding performance, aligning with our vision of a carbon-free society and our GREEN IMPACT plan.



**0,02** Global Warming Potential

Panasonic's newest series are engineered with industry leading natural refrigerant R290, which has a low Global Warming Potential (GWP) of just 0,02, helping reduce CO<sub>2</sub> emissions and environmental impact.

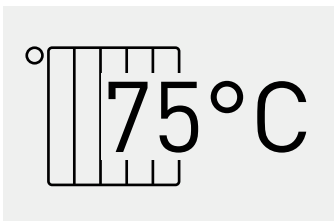

**Output water.**

Up to 75 °C water outlet down to -15 °C\* outdoor.

\* -10 °C for L Series. Down to 15 °C outdoor for 20, 25 and 30 kW models.

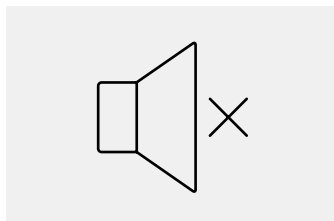

**Quiet operation.**

Only 27 dB(A) sound pressure at 5m\*.

\* Sound pressure calculation for WH-WDG05LE5, free standing, A +7 °C, W 35 °C in Quiet mode 3.

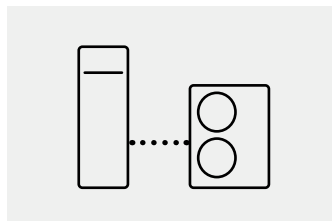

**Flexible hydraulic installation.**

Hydraulic connection between indoor and outdoor.

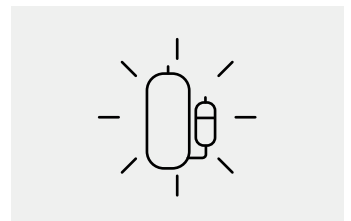

**Made and designed by Panasonic.**

Reliable outdoor units with Panasonic compressor.



**Output water. High performance under extreme conditions**

**Excellent solution for heating system retrofit.**

The compressor operates without backup heating down to -28 °C ambient temperatures, and can be integrated alongside existing radiators with a high-water flow temperature of up to 75 °C at -15 °C outside temperature. Even at -28 °C outside temperature, it can supply hot water at 55 °C.

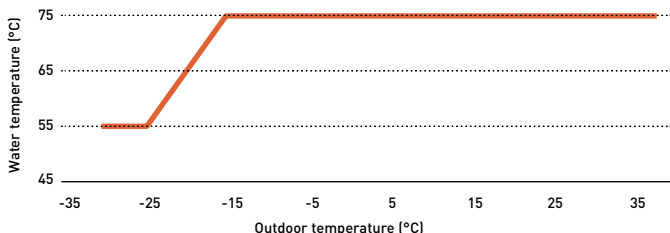

\* For M Series 9, 12 and 16 kW models. In case of L Series operation down to -25 °C and 75 °C water outlet down to -10 °C ambient.

**Sterilisation process without heater.**

It can also reach a domestic hot water temperature of up to 65 °C without the use of the electric heater, so the tank sterilisation can be performed with the heat pump operation.

**Quiet operation. Panasonic's unique low noise architecture**

The compressor, which is a major source of noise, is equipped with a double-bottomed structure to provide a safe, quiet structure that does not disturb neighbours in crowded residential areas.

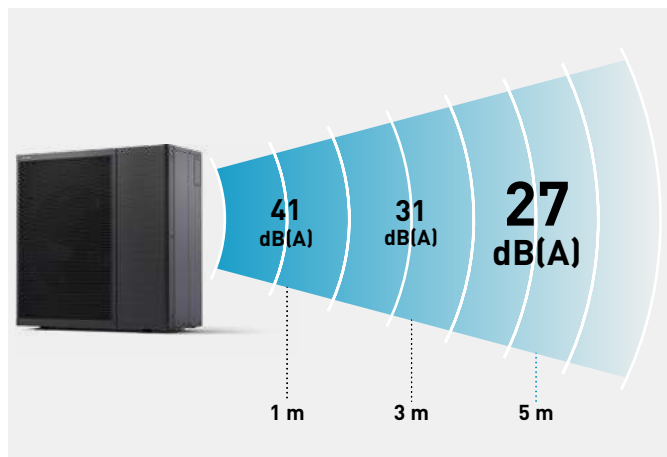

\* Sound pressure calculation for WH-WDG05LE5, free standing, A +7 °C, W 35 °C in Quiet mode 3.



**Flexible hydraulic installation**

The installation of the system is 100% hydraulic, with only water pipes between the outdoor unit and the interior of the home.

**More living space at home.**

No indoor safety measures needed for refrigerant or fuel gas piping.

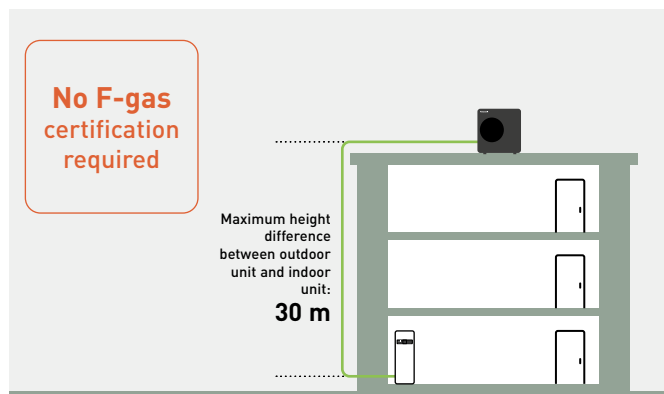

\* For L Series only when the outdoor unit is installed above the indoor unit, and the water pressure does not exceed 1 bar at the outdoor unit.

**Made and designed by Panasonic.**

**Aquarea High Performance L Series from 5 to 9 kW.**



Wi-Fi adapter included

**Aquarea T-CAP M Series from 9 to 30 kW.**



Wi-Fi adapter included

\* Check availability of units and combinations.

# Aquarea T-CAP M Series, the latest generation of Aquarea Heat Pumps with R290

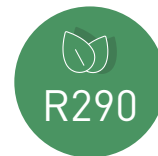

Introducing M Series T-CAP, innovative Aquarea Heat Pumps with natural refrigerant R290, delivering superior performance even in extreme conditions.



reddot winner 2024



GOOD DESIGN AWARD 2024

**BEST 100**

\* For 9, 12 and 16 kW single and three phase.



### Output water.

Up to 75 °C water outlet down to -15 °C outdoor\*.

\* Down to 15 °C outdoor for 20, 25 and 30 kW models.



### Quiet operation.

Only 29 dB(A) sound pressure at 5 m\*.

\* Sound pressure calculation for WH-WXG12ME5, free standing, A +7 °C, W 35 °C in Quiet mode 3.

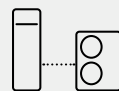

### Flexible hydraulic installation.

Hydraulic connection between indoor and outdoor.



### Made and designed by Panasonic.

Reliable outdoor units with Panasonic compressor.



### Panasonic Comfort Cloud App and Aquarea Service Cloud included.

Smart control and maintenance.

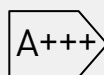

### High efficiency.

ErP 35 °C. Energy efficiency class up to A+++\*.

\* Scale from A+++ to D.



### Extreme conditions.

Compressor operating down to -28 °C outdoor temperatures.



### T-CAP.

Keeping heating capacity down to -20 °C.

**Flexible installation, suitable for retrofit and new buildings.**

Thanks to its new, modular concept, the outdoor unit can function independently with just an indoor remote control, for those seeking basic functionalities. Homeowners can opt for enhanced functionality by incorporating the more advanced control module or selecting between a Bi-bloc or All in One indoor units.



Available in 120 L, 185 L and 260 L DHW tank.



	Remote controller	Control module	Bi-bloc (available from 9 to 16 kW)	All in One (available from 9 to 16 kW)
CN-CNT	✓ [1]	✓ [2]	✓ [2]	✓ [2]
Backup heater	—	Field supply	✓	✓
Expansion vessel (10 L)	—	—	✓	✓
Additional functions	—	CZ-NS7P	CZ-NS6P	CZ-NS6P

**Output water. High performance under extreme conditions**

**Excellent solution for heating system retrofit.**

The compressor operates without backup heating down to -28 °C ambient temperatures, and can be integrated alongside existing radiators with a high-water flow temperature of up to 75 °C at -15 °C outside temperature. Even at -28 °C outside temperature, it can supply hot water at 55 °C.

\* For M Series 9, 12 and 16 kW models.

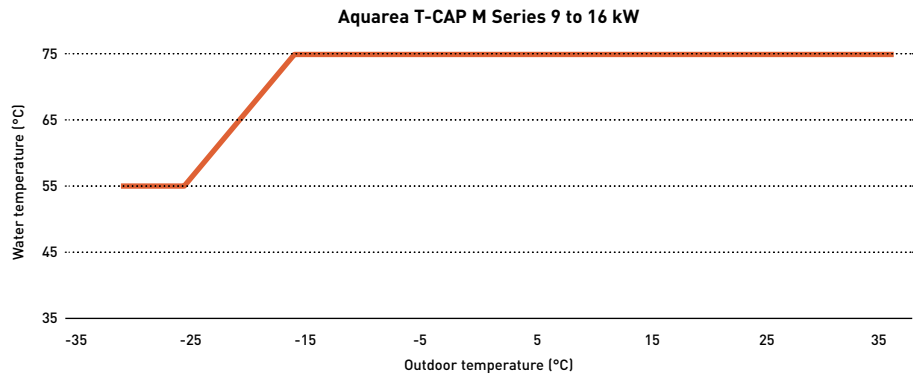

**Quiet operation. Panasonic's unique low noise architecture**

The compressor, which is a major source of noise, is equipped with a double-bottomed structure to provide a safe, quiet structure that does not disturb neighbours in crowded residential areas.

\* Sound pressure calculation for WH-WXG12ME8, free standing, A +7 °C, W 35 °C in Quiet mode 3.

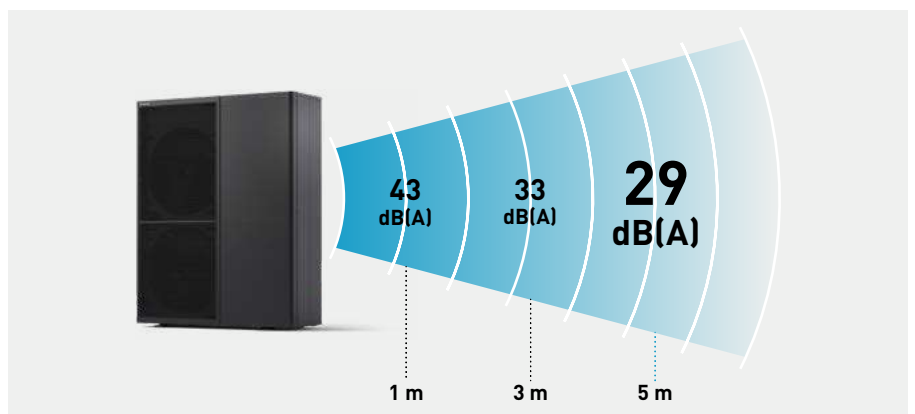

**Aquarea T-CAP, high performance whatever the climate**

With Aquarea T-CAP technology and the new compressor with Injection technology, Panasonic heat pumps can work in outdoor temperatures as low as -28 °C and maintain capacity without backup heating at -15 °C\*.

\* WH-WXG20/25/30ME8 work down to -25 °C outdoor.

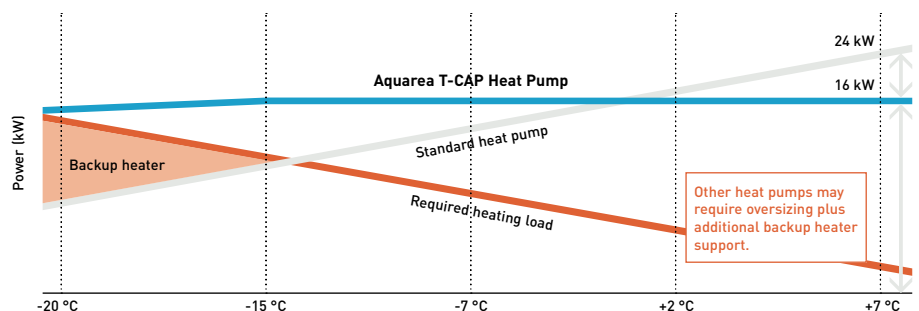

Other heat pumps may require oversizing plus additional backup heater support.

# Aquarea T-CAP M Series, the latest generation of high performance heat pumps with R290

Aquarea T-CAP M Series delivers a revolution in the design, performance, connectivity, and sustainability. Aligning with our vision of a carbon-free society and our GREEN IMPACT plan.



## High energy efficiency in heating and domestic hot water

The Aquarea M Series saves energy and significantly reduces operating cost by achieving the highest ErP energy rating.

Aquarea M Series can reach a domestic hot water temperature of up to 65 °C without the use of the electric heater, so the tank sterilisation can be performed with the heat pump operation for further energy savings.

\* Rating conditions: Heating: Inside air temperature: 20 °C Dry Bulb / Outside air temperature: 7 °C Dry Bulb / 6 °C Wet Bulb. Conditions: Water input temperature: 30 °C / Water output temperature: 35 °C. Energy rating for WH-WXG12ME8.

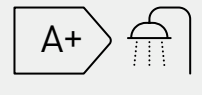

**Energy efficiency class up to A+.**  
Scale from A+ to F.

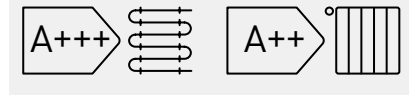

**ErP 35 °C / 55 °C.**  
**Energy efficiency class up to A+++/A++.**  
Scale from A+++ to D.

## Maximising hot water comfort

- Up to 40% more tap water with a higher tank temperature setting to save space
- New domestic hot water circulation mode for instant availability of hot tap water
- During sterilisation, the domestic hot water circulation mode is activated to ensure sterilisation of the water pipes

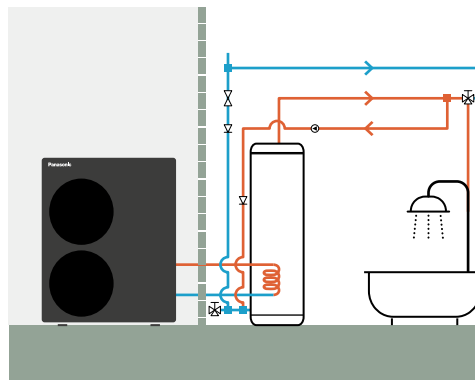

The hot water in the pipes recirculates back to the tank at set intervals during the set time period, ensuring instant hot water for the end user.

## Internet adapter included for Smart Control and remote maintenance

The Aquarea M Series comes standard with an internet adapter for Wi-Fi or WLAN connection. It can be easily connected via the front panel of the indoor units or the control module, providing flexible and intuitive connectivity.



**Reliable technology.**

The outdoor units are equipped with a Panasonic R290 scroll compressor. The compressor is manufactured in-house with T-CAP technology including injection. The outdoor heat exchanger is protected with a Bluefin treatment for harsh ambient conditions.

**Great serviceability**

Cutting-edge outdoor unit design keeps the PCB in a safe and accessible location.

**Aquarea M Series safety optimisation.**

- 1 | Non-flammable control box
- 2 | Power box cable gland with sealed connections
- 3 | Air/refrigerant separator

\* This image applies to 9, 12 and 16 kW.

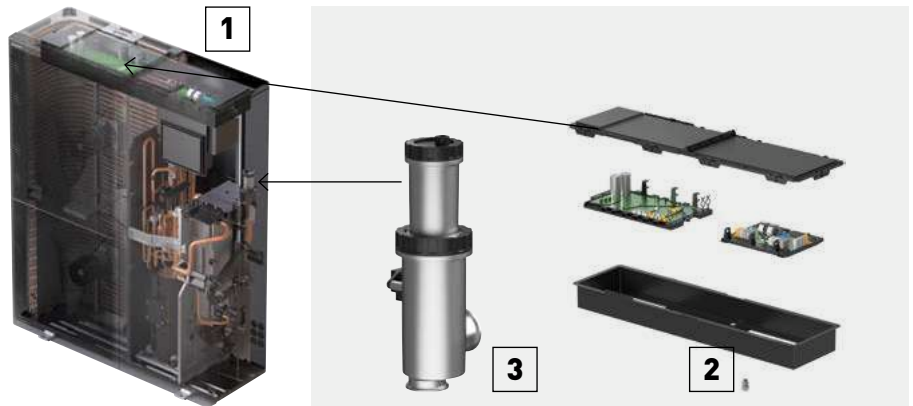

# Big Aquarea T-CAP M Series, the ideal solution for centralised heating and DHW installations

The new Big Aquarea M Series offers a flexible, compact and energy-efficient solution for central heating and/or domestic hot water installations in multi-family or commercial buildings.

The solution is suitable for both new buildings and retrofits, as it offers a more sustainable alternative to traditional fossil fuel heating systems and it can be easily integrated with existing water system such as fan coils, floor heating or domestic hot water tanks.

<p><b>Up to 300 kW in cascade.</b></p>	<p><b>Compact solution with small footprint.</b></p>	<p><b>Keeping capacity at 55 °C water outlet down to -15 °C outdoor.</b></p>	<p><b>Quiet operation.</b></p>	<p><b>Panasonic Inverter compressor.</b></p>	<p><b>DHW at 65 °C with compressor only.</b></p>
--	--	--	--------------------------------	--	--

- Units from 20 to 30 kW, up to 300 kW in cascade
- Easy replacement of other heating sources
- Flexible control options: remote control only or control module for enhanced functionality
- Seamless Modbus integration
- Designed to blend with architecture and environment



**Maintained capacity.  
Time-saving installation.  
Cost-saving.  
Space-saving.**

<p><b>2x 20 kW heat pump</b></p> <p><b>Conventional cascade system</b></p>	<p>➔</p>	<p><b>1x 30 kW Big Aquarea T-CAP</b></p> <p><b>New Panasonic Aquarea T-CAP M Series</b></p>
--	----------	---

For 30 kW demand at 55 °C water outlet and -7 °C outdoor temperature.

# Big Aquarea for centralised heating and DHW installations in multi-family or commercial buildings

The new Big Aquarea M Series offers a flexible, compact and energy-efficient solution for central heating and/or domestic hot water installations in multi-family or commercial buildings.

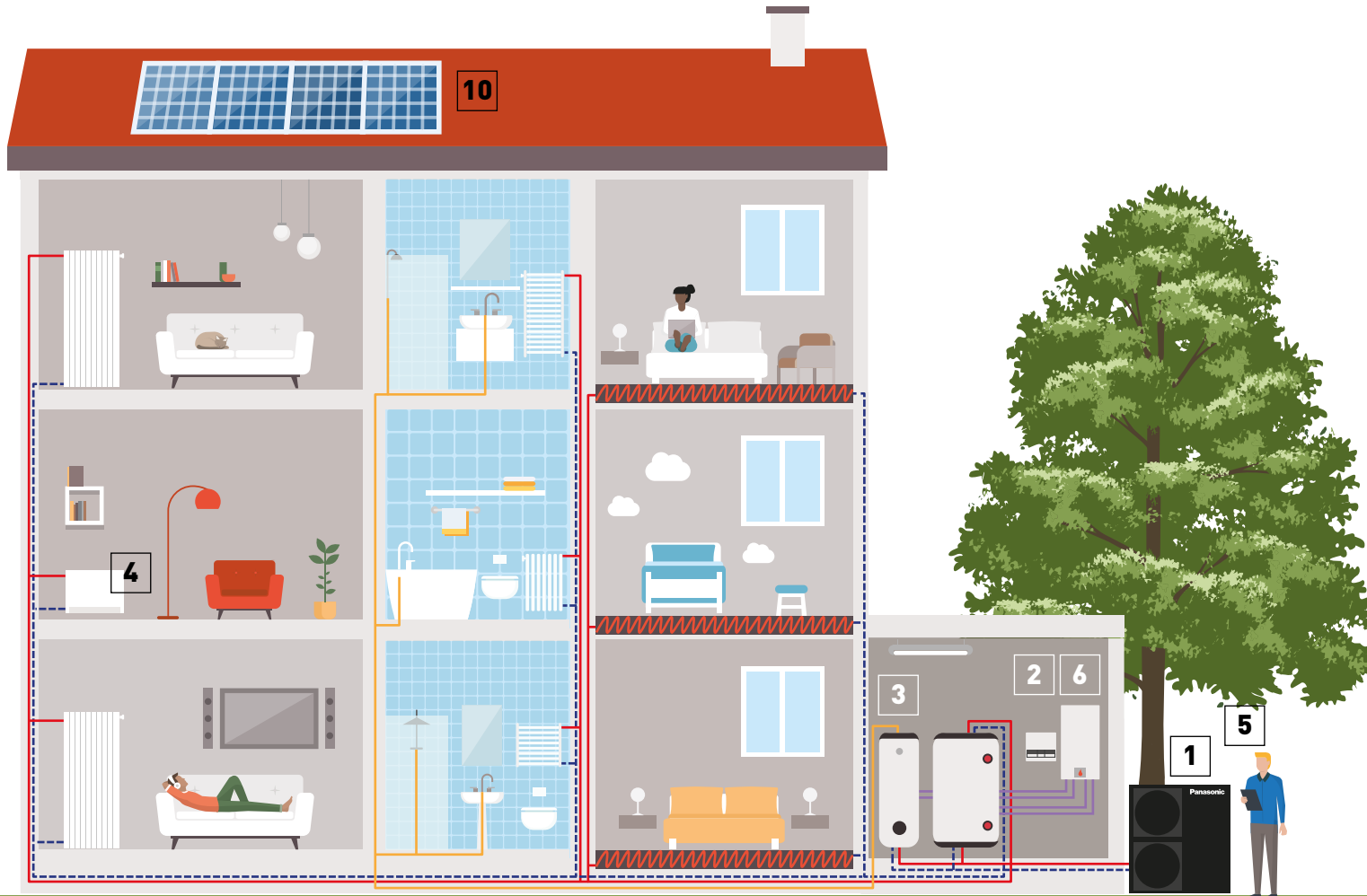

**1**  
**Big Aquarea T-CAP M Series.**  
25 kW heat pumps in cascade, for a space-saving solution. It can replace an old fossil fuel boiler.



**2**  
**M Series control module.**  
The control module allows for enhanced control functionality. Operation with the remote controller only is also possible.



**3**  
**High efficiency DHW tank.**  
A high efficiency tank provides the required volume of hot water, at the correct temperature, reducing energy costs.



**4**  
**Aquarea Loop.**  
The water loop heat pump provides heating and cooling for every apartment or room connected to a central water loop.



**4**  
**Fan coils, radiators or floor heating.**  
Aquarea Heat Pumps can be integrated into a new or existing water system.



**5**  
**Aquarea Service Cloud.**  
This IoT solution provides powerful and user-friendly management and monitoring of Aquarea Heat Pumps and enables remote maintenance.

## A revolution in the design, performance, connectivity, and sustainability.

- Scalable solution, up to 300 kW in cascade
- Suitable for new build and retrofit
- Up to 75 °C water outlet
- Easy replacement of other heating sources and integration into existing water systems
- Quiet operation
- Maintains output at 55 °C down to -15 °C
- Hot water production at 65 °C with compressor only
- Flexible control options and seamless Modbus integration

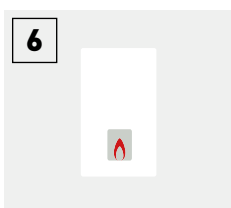
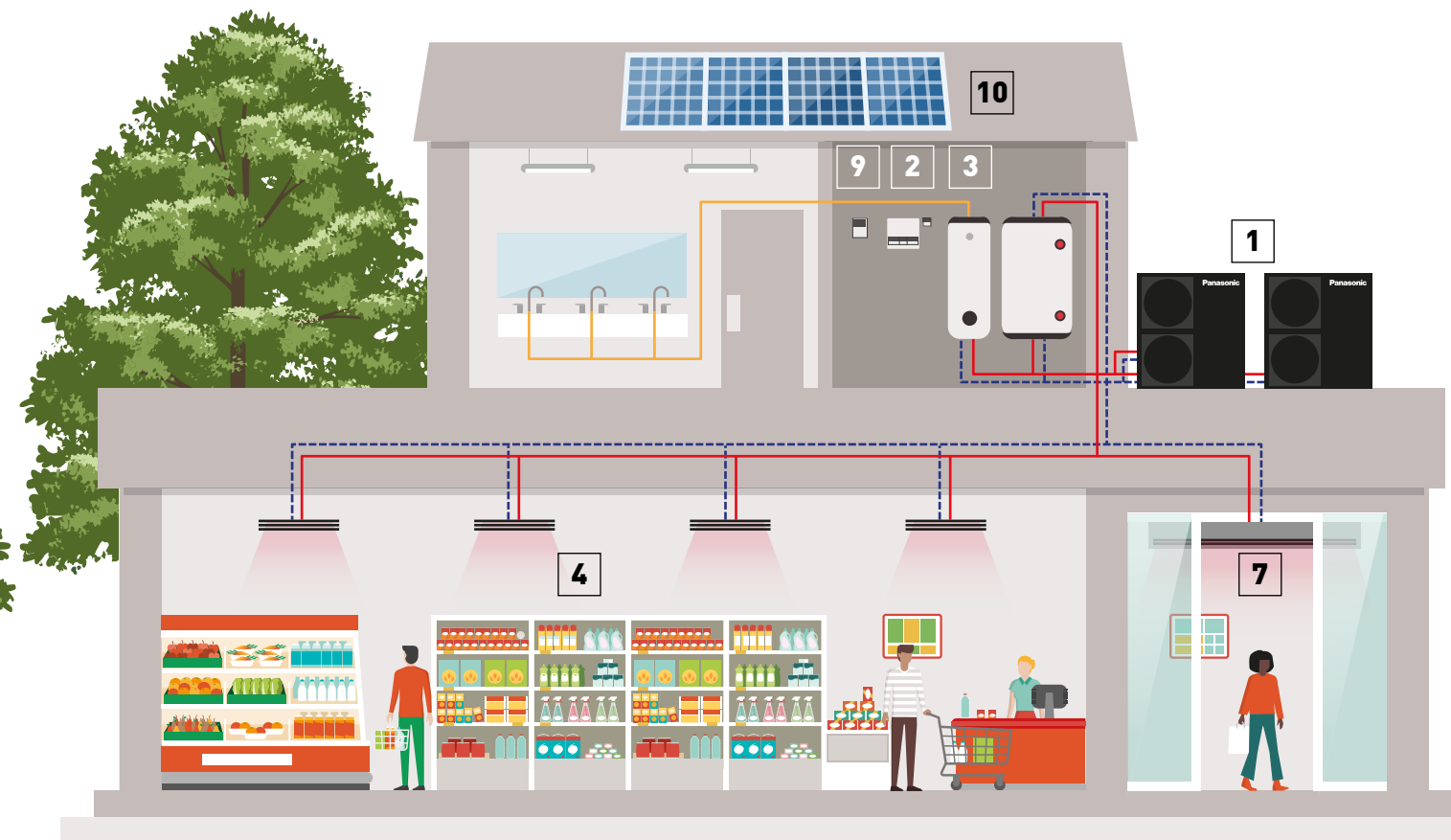

**OPTIONAL.**  
**Bivalent mode.**  
Cost-effective bivalent mode with energy tariff logic when combined with an existing boiler.



**Air Curtain with water Coil.**  
Water coil air curtains can be used in the hydraulic system to have efficient performance of the water system.

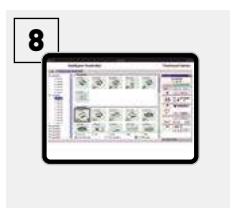

**BMS integration.**  
The system can be easily integrated into a Modbus project with the optional accessory.



**Cascade manager.**  
Manages up to 10 Aquarea Heat Pumps, balancing working hours, can control up to 2 buffer tanks and integrates PV, among others.



**Photovoltaics.**  
Thanks to the integration with PV, the demand or power consumption for heating or hot water production is adapted to the PV production.



### **Burger & Lobster restaurant. Bath, UK.**

Panasonic's air to water Aquarea system has been installed in the latest glamorous Burger & Lobster restaurant in Bath. The Octagon Chapel, a large listed building in the city centre, was converted to accommodate the restaurant, and Panasonic's Aquarea system provided an extensive, energy efficient and unobtrusive heating and cooling solution.

## Aquarea Loop, the water loop heat pump for multi-family buildings

The Aquarea Loop is a decentralised water-to-air heat pump using R290, designed to provide heating and cooling for each apartment connected to a central water loop.





The system circulates water year-round at a neutral temperature (20 ~ 30 °C), preventing condensation on uninsulated pipes during summer. The Aquarea Loop adjusts the water temperature to optimal levels, ensuring each room is properly heated or cooled.

This setup maximizes the use of renewable energy, minimizes heat losses in distribution, and enhances the environmental performance of the apartment building.

**Aquarea Loop efficiently upgrades the heat of the low temperature loop. Thus, a lower temperature may be used.**

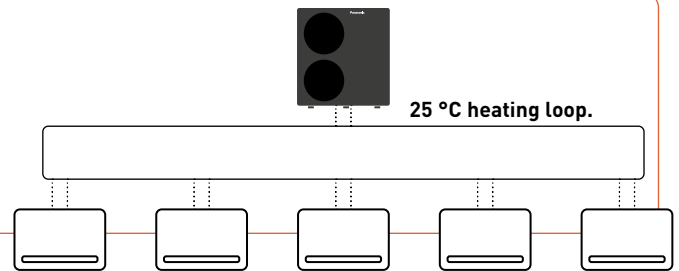

**Efficiently replaces existing radiators in centralised heating systems.**

Aquarea Loop offers low thermal losses and high seasonal efficiency. Enjoy simultaneous heating and cooling while effortlessly integrating with existing pipework for seamless renovations.

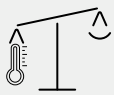

**Low thermal losses.**



**High seasonal efficiency of the entire system.**



**Simultaneous heating and cooling.**



**Use of existing pipework for renovations\*.**

\* Based on the low flow rate requirement – must be checked on each project.

#### And more:

- Compact indoor unit – depth of only 140 mm
- DC Inverter compressor with R290
- Lower CO<sub>2</sub> emissions than traditional heating systems
- Utilizes renewable energy
- Improves the energy class of the building
- No thermal losses in distribution
- Reduced operating costs
- No need for gas connection or chimney
- Easy installation
- Connects to individual apartment's electricity
- Accurate energy allocation for each Aquarea Loop with metering

#### Retrofit application: centralised low temperature installation for decentralised heating and cooling

The Aquarea Loop is the perfect replacement for existing radiators, ensuring optimum temperatures all year round.

- 1 | Centralised Aquarea Heat Pump (first stage of generation) replacing a high temperature traditional heat source
- 2 | Loop water temperature 20 ~ 30 °C. The existing pipework may be reused
- 3 | Aquarea Loop heat pump (second stage of generation) replacing conventional radiators

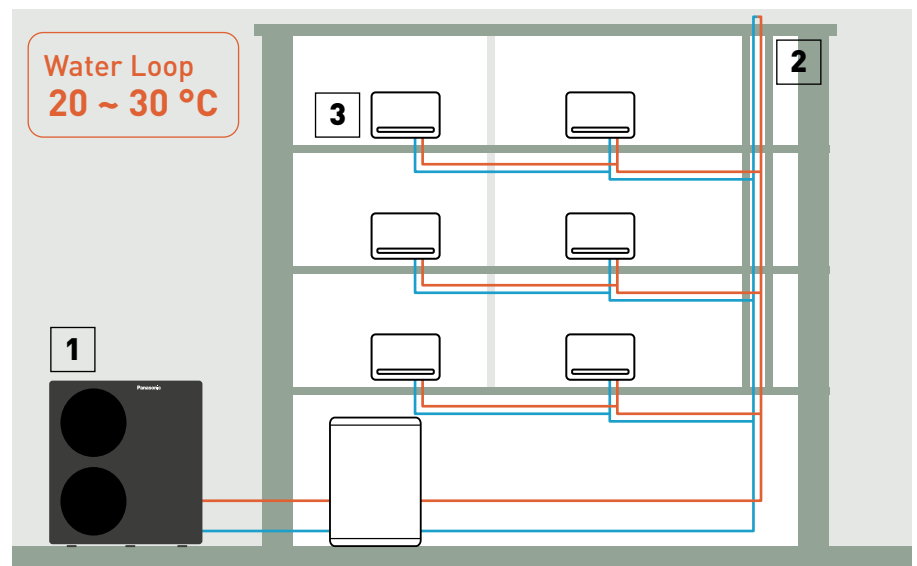

## Aquarea All in One Hydraulic M Series

The ultimate space-saving solution. Available in 120 L, 185 L and 260 L DHW tank, with a footprint of just 599 x 602 mm.



## Premium white indoor units.

The indoor unit is designed to blend into your interior space effortlessly. In premium white, faithful to the Aquarea spirit, underlined by the seamlessly integrated controller which provides a sleek black band across the unit.

## New All in One with 120 L DHW tank



**599 x 602 mm footprint** reduces required installation space.



**No buffer tank required,** reducing space, cost and installation time.



**Up to 40% more tap water** with a higher tank temperature setting.

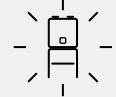

**Robust body and top surface** enables installation of a top ventilation unit.

## Aquarea All-in-One M series: the best Panasonic technology.



\* Tentative information.

### Great serviceability.

- Easy access to hydraulic part thanks to door opening mechanism
- All sensors can be checked from the remote controller
- Water pressure sensor and reading on home-screen

### Other high quality components inside.

- Maintenance free Inox stainless 120 L, 185 L or 260 L tank
- Variable speed water pump ("A class")
- Backup heater
- 3 way valve inside



### Extended elevation difference (up to 30 m).

With the new expansion vessel, the All in One M Series allows a high indoor/outdoor height difference of up to 30 m.

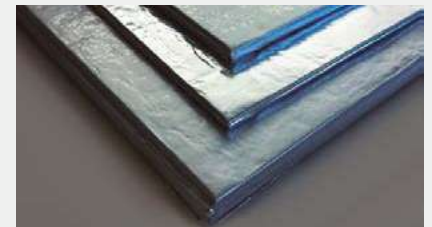

### U-Vacua™ Vacuum insulation panel.

U-Vacua™ panels offer 19 times the insulation performance of polystyrene foam. Since the system retains heat longer, it needs to heat up fewer times each day, resulting in energy savings.

## Aquarea All in One with 2 zones.

### The optimal solution for installations with 2 heating zones.

- 2 heating circuits, with 2 different water temperatures
- 2 variable speed water pumps "A class" and 2 water filters
- Floor heating water control with mixing valve

\* Only available with a 185 L DHW tank.

## Aquarea All in One with Electrical Anode:

The All in One with built-in impressed current anode is the ideal solution for installations in locations with harsh water conditions.

# Aquarea K Series

A revolution in design, efficiency, connectivity and sustainability. Aquarea K Series is a ground breaking low-energy system for heating, cooling and domestic hot water production that delivers outstanding performance. This model is ideal for new installations and well-insulated homes.



<p><b>Wide range.</b> Wide range to suit all homes: High Performance and T-CAP.</p>	<p><b>Further noise reduction.</b> -8 dB(A) in Quiet mode.</p>	<p><b>Optional remote control and maintenance.</b> Panasonic Comfort Cloud App and Aquarea Service Cloud.</p>	<p><b>High energy efficiency for heating.</b> High energy class for low temperature applications*.</p>	<p><b>High energy efficiency for domestic hot water.</b> DHW COP up to 3,5*. <small>* Scale from A+ to F.</small></p>	<p><b>Output water.</b> Up to 60 °C water outlet down to -10 °C outdoor.</p>

## Further advanced features

- High tank insulation performance thanks to U-Vacua™\*.
- All in One indoor unit available in 185 L and 260 L
- Less frequent maintenance with pre-installed magnet filter
- Water pressure sensor built-in

- Easy access to hydraulic parts
- Operation without backup heater at -25 °C
- Bluefin treatment protection on outdoor heat exchanger for harsh ambient conditions

\* Only applicable to All in One indoor unit. U-Vacua™ is a vacuum insulation panel (VIP) technology.

## Aquarea K Series keeps 60 °C water outlet temperature even at very low temperatures

Aquarea K Series is able to keep 60 °C water outlet temperature in outdoor temperatures down to -10 °C, keeping high comfort in the room even at low temperatures. With other heat pumps, water temperature dramatically drops at low outdoor temperatures, making the heat pump to work out of the design conditions and creating discomfort inside the room.

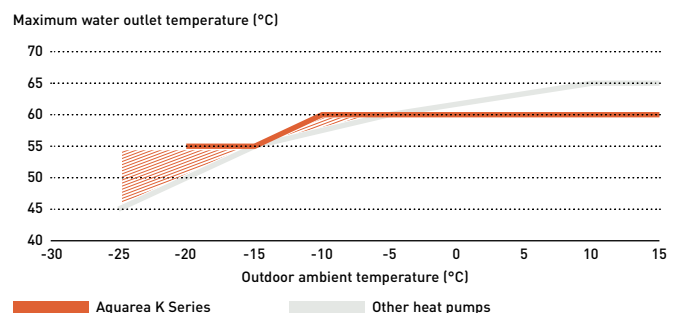

## Aquarea K Series for every project need.

Available in both T-CAP and High Performance, the Aquarea K Series offers a versatile range of solutions to suit different project sizes and needs.



### The outdoor unit is designed to harmonize with architecture and the environment

The compressor, which is a major source of noise, is equipped with a double-bottomed structure to provide a safe, quiet structure that does not disturb neighbours in crowded residential areas.



**-8 dB(A) in Quiet mode**

### Aquarea High Performance K Series.

**For new installations and low consumption homes.** Suitable for a wide range of properties that demand exceptional efficiency and high energy savings. Featuring COPs as high as 5,33<sup>1)</sup> this solution is perfect for either underfloor heating or low temperature radiators.

1) K and J Series 3 kW.

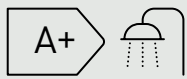

**Energy efficiency class up to A+.**

Scale from A+ to F.

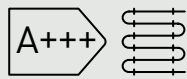

**ErP 35 °C. Energy efficiency class up to A+++.**

Scale from A+++ to D.

\* Rating conditions: Heating: Inside air temperature: 20 °C Dry Bulb / Outside air temperature: 7 °C Dry Bulb / 6 °C Wet Bulb. Conditions: Water input temperature: 30 °C / Water output temperature: 35 °C. These energy efficiency might not apply to all models.

**With a COP of 5,33, the Aquarea Heat Pumps offers savings of up to 82% on heating costs compared to electric heaters, as a large portion of the energy is extracted from the air for free.**

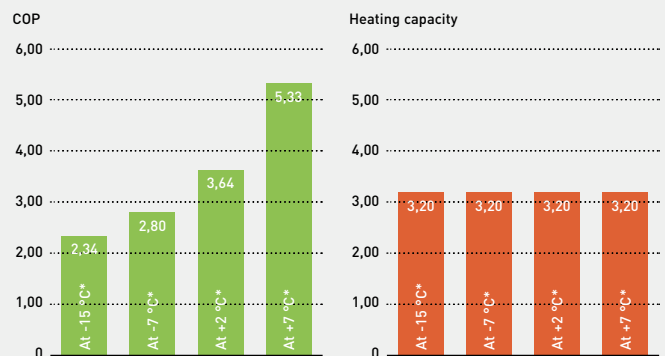

\* KIT-ADC03K3E5 at 35 °C water outlet.

### Aquarea T-CAP K Series.

**For retrofit and new builds, the ideal solution for those installations where the output capacity is demanding.**

The entire Aquarea T-CAP line-up is excellent for replacing gas or oil boilers and for connecting to new underfloor heating, radiators or fan coil units.

Aquarea T-CAP can maintain the rated heating capacity even at -20 °C<sup>1)</sup> outdoor temperature, without requiring an electrical heater. This makes it an ideal solution for locations with extremely low temperatures

1) At 35 °C flow temperature.

### Aquarea T-CAP, high performance whatever the climate

With Aquarea T-CAP technology, Panasonic heat pumps can work in outdoor temperatures as low as -28 °C and maintain capacity without backup heating at -20 °C\*.

\* At 35 °C flow temperature.

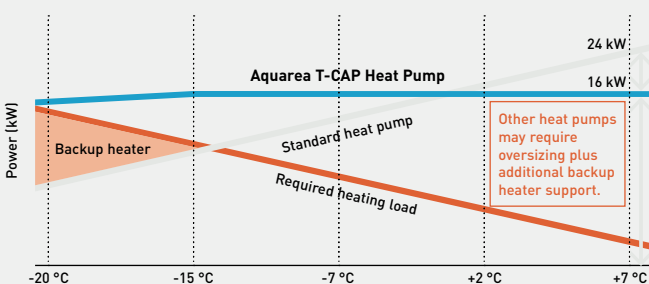

### How Aquarea T-CAP K Series maintains performance even at -20 °C outdoors

A patent has been obtained for technology that can maintain heating capacity even in low outdoor temperatures through optimal control that comes from incorporating dual-piped heat exchanger into the refrigeration cycle.

**Dual-piped heat exchanger.** Low pressure and low-temperature refrigerant in the inner pipe.

Image of the Aquarea T-CAP J Series Mono-bloc.

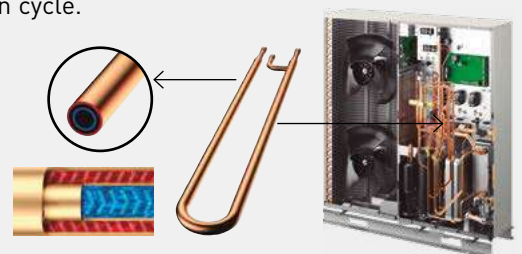

# Aquarea EcoFlex

**2-in-1 - Sustainable and efficient comfort all year long.**

Aquarea EcoFlex is a groundbreaking heat pump that connects an air ducted unit with nanoe™ X technology providing heat recovery hot water, space heating, space cooling and cleaner air. Outstanding efficiency and energy savings with low CO<sub>2</sub> emissions.



Heating, cooling and domestic hot water systems for a green future.

With Aquarea Heat Pump the heat energy is taken from the ambient air. One outdoor unit for synchronous air to air and air to water supply.

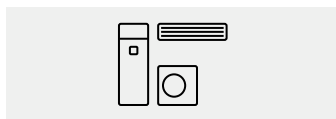

**Multi solution.**

Trendy air to water + DX value added solution, featuring bi-heating (simultaneous air heating and DHW or heating), heat recovery function (re-use wasted heat from the outdoor unit for DHW production) and Non-stop heating (air heating runs continuously even in defrost operation).

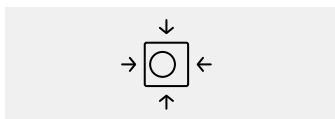

**Compact design.**

Ideal for installations with limited spaces. The compact outdoor unit can supply both air conditioning and hot water at the same time. The Tank fits beautifully in any kitchen, small laundry space, or any other desired area. No need for gas supply.



**Smart convenience.**

Energy savings, comfort and control from anywhere. Aquarea EcoFlex is equipped standard with Wi-Fi to enable smart control and energy consumption monitoring, using Aquarea Smart Cloud.



**nanoe™ X technology to improve protection 24/7.**

This advanced technology utilises hydroxyl radicals (also known as OH radicals), which inhibit the growth of certain pollutants such as allergens, bacteria, viruses, moulds, odours, and certain hazardous substances.



Unique technology that drives the system

**Heat recovery.**

Cooling (air to air) + DHW (air to water).

Heat exchange that took place in outdoor unit now is carried out in the water heater.

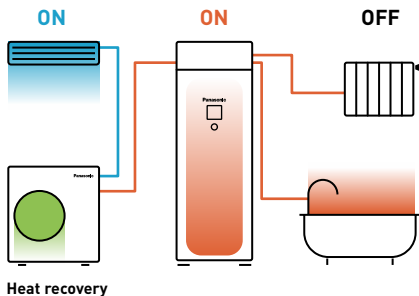

**Bi-heating.**

Heating (air to air) + Heating (air to water) or DHW.

Heat from the compressor is supplied for heating and DHW simultaneously.

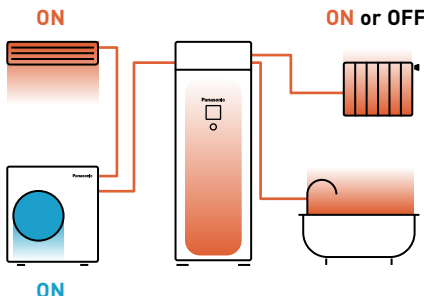

**Non-stop heating.**

Heating (air to air) continuous operation.

Use heat from tank to defrost and heat simultaneously.

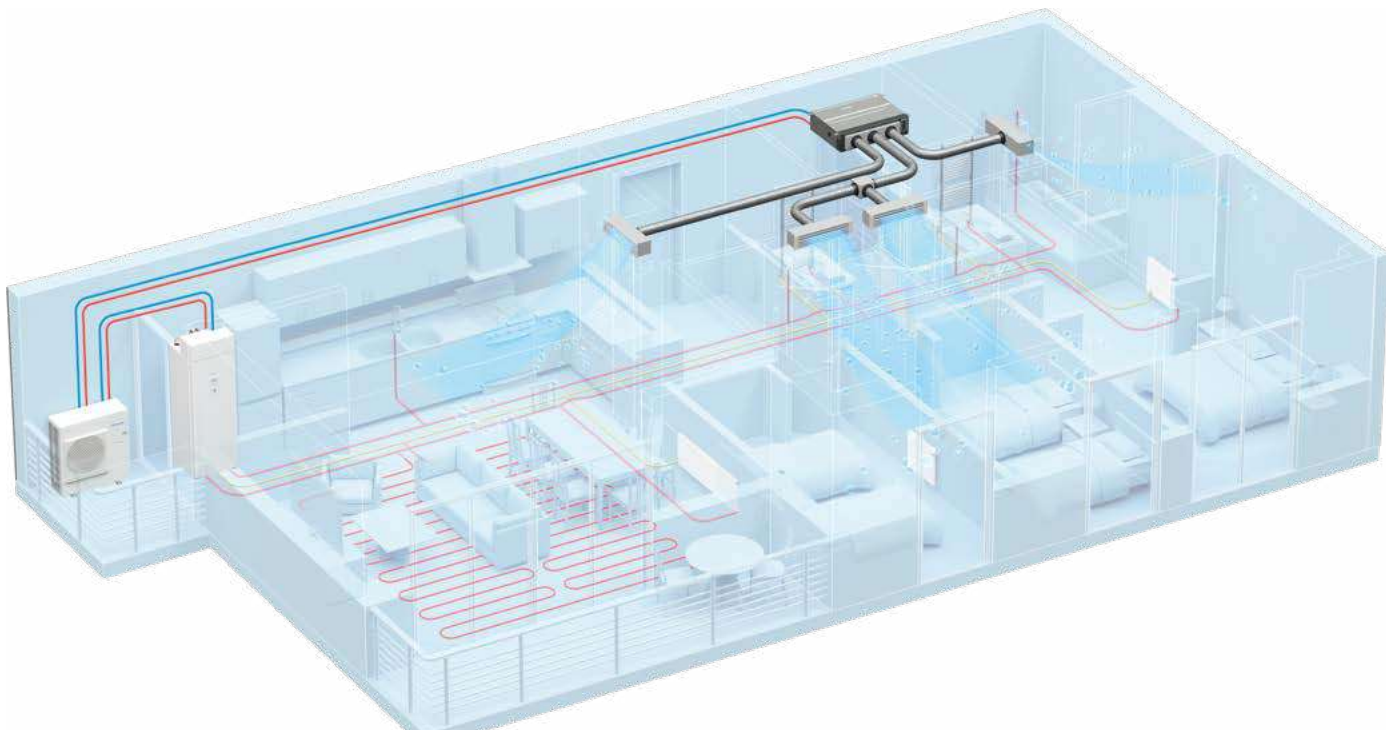
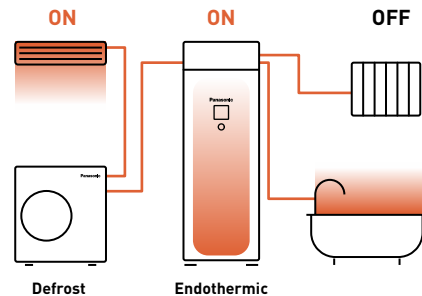

# Aquarea EcoFlex.

## Air to water

Tank unit + heat exchanger box to produce domestic hot water and space heating using radiators or floor heating.

Fits beautifully in any kitchen, small laundry space, or any other desired area

Kitchen.



Laundry space.



The same depth as a regular refrigerator/washing machine.

Deep: 600 mm  
Wide: 598 mm

Deep: 600 mm  
Wide: 600 mm

Deep: 600 mm  
Wide: 600 mm

### Compact, yet easy to maintain



#### 1 | Heat exchanger box structure to mitigate R32 refrigerant restrictions, flexible installation.

Water heat exchanger is designed above the top plate to comply with installation area regulation for products using large amounts of R32 refrigerant.



Adapted door opening mechanism

#### 2 | Maintained serviceability.

- Easy maintenance concept
- Access to hydraulic parts thanks to door opening mechanism
- No buffer tank required, reducing space, cost and installation time



Width: 116 mm  
Height: 250 mm

#### 3 | Improved water filter for less maintenance.

Superior dust removal capacity of the water filter. Less frequent filter cleaning means more convenience.



Deep: 600 mm  
Wide: 598 mm

185 L

#### 4 | Slim indoor unit with big tank capacity.

Built-in 185 L water tank in a slim W 598 x D 600 mm indoor unit housing.

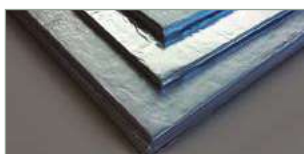

#### 5 | U-Vacua insulation technology.

Panasonic U-Vacua™ is a high performance vacuum insulation panel with very low thermal conductivity, that performs about 19 times better than standard urethane foam.

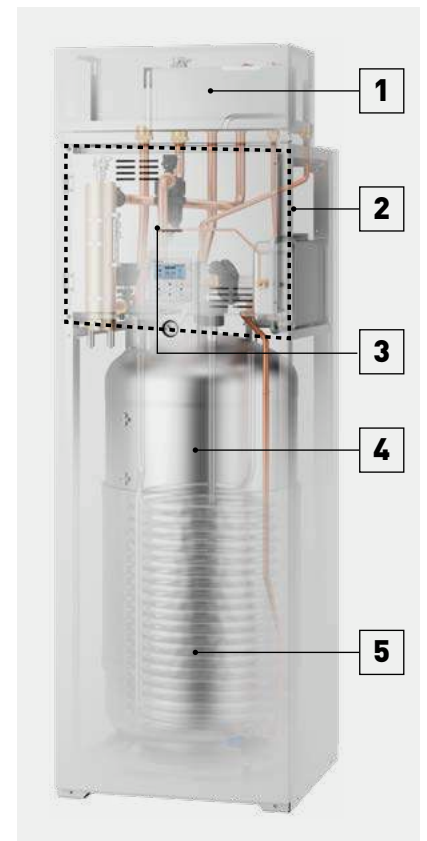



# Aquarea EcoFleX. Air heating or cooling and cleaner air

Aquarea EcoFleX ducted unit has been designed to provide better comfort and flexibility.



[+ SEE PRODUCT SPECIFICATIONS](#)

## Superior air quality

Standard equipped with nanoe™ X, a unique technology that cleans indoor air.



## Ideal for living spaces

- Static pressure level: 10 - 150 Pa
- Compact body: Only 250 mm high
- Smart control ready via CONEX
- Rated up to SEER / SCOP class A+/A
- Low noise operation (34 dB(A)) using an improved fan casing
- DC fan motor, built-in drain pump



## Panasonic's nanoe™ X technology takes this a step further and brings nature's detergent – hydroxyl radicals – indoors to help create an ideal environment

Thanks to the nanoe™ X properties, several types of pollutants can be inhibited such as certain types of bacteria, viruses, mould, allergens, pollen and certain hazardous substances.

### Deodorises

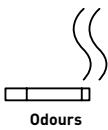

### Capacity to inhibit 5 types of pollutants



The nanoe™ X performance varies depending on the room size, environment and usage and it may take several hours to reach the full effect. nanoe™ X is not medical device, local regulations on building design and sanitary recommendations must be followed.

[+ REFER TO PAGE 14 FOR MORE DETAILS AND VALIDATION DATA](#)

## nanoe™ X: improving protection 24/7



Acts to clean your air, so that the indoor environment can be a cleaner and more pleasant place to be all day long. nanoe™ X works together with heating or cooling function when you are at home and can work independently when you are away. Give the air conditioning the strength to increase the protection at home with nanoe™ X technology and convenient control via the Panasonic Comfort Cloud App.



### Cleans the air when you are away.

Leave the nanoe™ mode ON to inhibit certain pollutants and deodorise before you return home.

### Improves your environment when you are at home.

Enjoy a cleaner, comfortable space with loved ones.

## Selectable inlet air position

Inlet air position may be adjusted by means of a removable panel, to allow rear or bottom entry, depending on the duct installation.

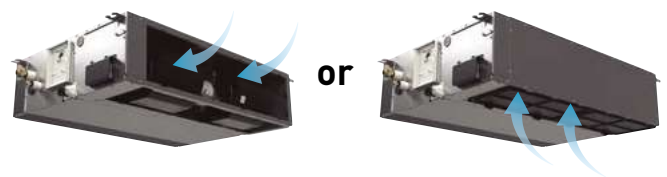

## Compact body

- Only 250 mm high
- Light units from 25 to 39 kg

Conventional model	33 kg	290 mm
Ducted unit	30 kg	250 mm

### Ducted unit





# Smart Solutions for Aquarea systems

Panasonic provides a comprehensive range of smart solutions for managing heating, cooling, and domestic hot water installations with Aquarea Heat Pumps. Each app features advanced functionality, user-friendly interfaces, and seamless connectivity, providing complete control and optimization of Aquarea systems.



With multiple apps designed to meet a variety of requirements, the optimal solution can be chosen based on the specific needs of the project—whether it’s achieving greater energy savings, enhancing comfort, or ensuring peace of mind with remote maintenance by a service partner.

Compare Aquarea Smart Solutions	 Comfort Cloud	 Aquarea Home	 tado°
	<b>Panasonic Comfort Cloud App</b>	<b>Aquarea Home App</b>	<b>tado°</b>
<b>Aquarea Heat Pump management</b>	✓ Requires Cloud adapter CZ-TAW1B/ CZ-TAW1C. Included with Aquarea L, M Series and EcoFlex.	✓ Requires Home Network Hub PCZ-ESW737.	✓ Requires Heat Pump Optimizer X PAW-THPOXE.
<b>Remote maintenance via Aquarea Service Cloud</b>	✓	—	—
<b>Room control</b>	✓ 1 or 2 heating zones control	✓ Aquarea Air Smart fan coils Aquarea Loop Aquarea Vent RAC Solo Requires remote control with Wi-Fi or Home Network Hub PCZ-ESW737.	✓ Radiators Underfloor heating Requires tado° Room control devices and Heat Pump Optimizer X or Bridge X.

# New Aquarea Home App, seamless control of all Aquarea room solutions



Aquarea Home

Introducing the Aquarea Home App: Effortlessly manage the Aquarea room solutions anytime, anywhere, 24/7.

**The Aquarea Home App enables seamless control and monitoring of the Aquarea room solutions through an intuitive, user-friendly interface**

The app provides centralised management of Aquarea Air Smart fan coils, Aquarea Loop, RAC Solo and Aquarea Vent ranges using a smartphone or tablet. It can also integrate Aquarea Heat Pumps, allowing complete control of the entire heating and cooling system, all from a single app <sup>1)</sup>.

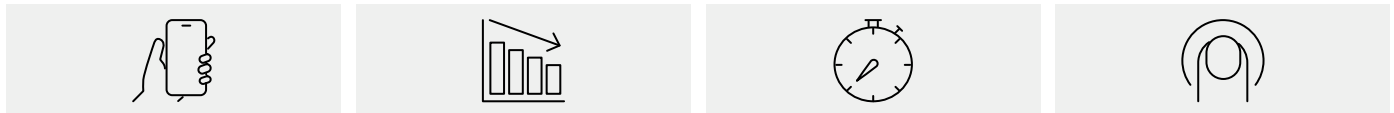

**Centralised remote control.**

Manage all your Aquarea systems from one app.

**Further energy savings.**

Control individual rooms or zones.

**Weekly timer.**

Calendar system for all home devices.

**User-friendly interface.**

Easily manage home comfort.

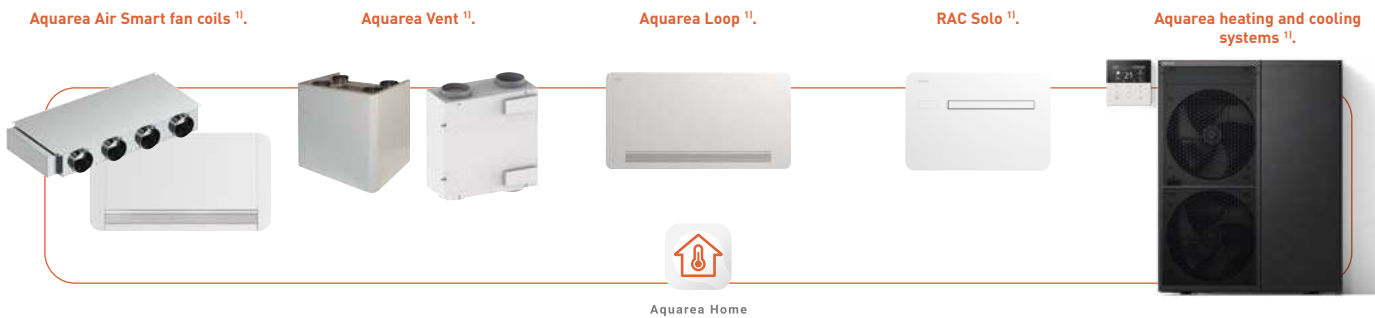

**Comfort management, anytime, anywhere.**

- Home and room management
- Device settings
- Scheduling



**Requirements for connecting with Aquarea Home App**

- 1 | Compatible devices (see list)
- 2 | In-house WLAN or Wi-Fi internet connection
- 3 | Smartphone or tablet with internet connection

**Compatible devices:**

- Aquarea Air Smart fan coils (via Wi-Fi or Modbus <sup>1)</sup>)
- Aquarea Loop (via Wi-Fi or Modbus <sup>1)</sup>)
- Aquarea Vent (via Wi-Fi or Modbus <sup>1)</sup>)
- RAC Solo (via Wi-Fi or Modbus <sup>1)</sup>)
- Aquarea Heat Pumps (require connection of the Home Network Hub PCZ-ESW737 via the CN-CNT port)

<sup>1)</sup> Aquarea room solutions a remote control with Wi-Fi connection or Aquarea Home Network Hub PCZ-ESW737. Aquarea Heat Pumps require PCZ-ESW737 connected to the CN-CNT port.

**Download free app: Aquarea Home App.**

Other hardware requirements: Router and Internet (purchase and subscribe separately). Panasonic Cloud Server is designed, operated and managed by Panasonic.



Aquarea Home



Download on the App Store



GET IT ON Google Play

# Panasonic Comfort Cloud App

A powerful and intuitive app designed to manage and monitor your Panasonic heat pumps from anywhere, 24/7. With energy monitoring features, it helps reduce operational costs while ensuring your desired comfort.



Comfort Cloud

\* Requires Wi-Fi adapter CZ-TAW1B or CZ-TAW1C.



Remote control.



Weekly timer.



Monitor energy consumption.



Enables Aquarea Service Cloud for remote maintenance.

## Comfort management, anytime, anywhere.

Easily control heating, cooling, and DHW settings through an intuitive interface, maximising energy savings and comfort.

- Control of up to 2 heating zones (ON / OFF, temperature setting, mode selection, DHW setting)
- Optimised scheduling with weekly timer

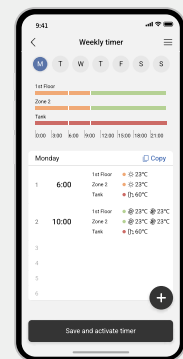
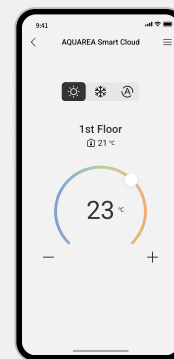
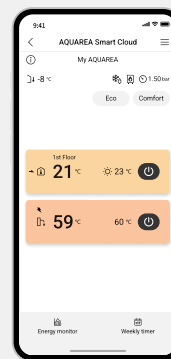

## Easy and powerful energy management.

Monitor and optimise your heat pump's energy usage to balance comfort and efficiency.

- Track energy consumption for space heating, cooling and domestic hot water
- Daily, weekly and yearly energy visualisation monitor energy recovery for domestic hot water production with Aquarea EcoFlex



## Further peace of mind.

Ensure your Aquarea Heat Pump is always under control.

- Enables remote maintenance via the Aquarea Service Cloud, managed by service partners
- Notification in case of malfunction

## Requirements for connecting with Panasonic Comfort Cloud App

- 1 | Aquarea H Series or later
- 2 | Cloud adapter CZ-TAW1, CZ-TAW1B or CZ-TAW1C connected via the CN-CNT port. Included in M and L Series, and EcoFlex. For other series, it needs to be purchased separately.
- 3 | In-house WLAN or Wi-Fi internet connection
- 4 | Smartphone or tablet with internet connection

## Download free app: Panasonic Comfort Cloud App.

Other hardware requirements: Router and Internet (purchase and subscribe separately). Panasonic Cloud Server is designed, operated and managed by Panasonic.



Comfort Cloud



Download on the App Store



GET IT ON Google Play

# Aquarea Service Cloud

With the Aquarea Service Cloud, installers can remotely take care of their customers' heating systems. It saves time and money and shortens the response time, thus increasing the customers' satisfaction.



WATCH DEMO

The real remote maintenance made simple: Global view at a glance, heat pump information and settings, error log history and statistics always available.



### Time and cost saving.

Remote system adjustment. Remote diagnosis. One visit, spare part in hand.



### Increased customer satisfaction.

Faster service. Time saving (less number of visits).

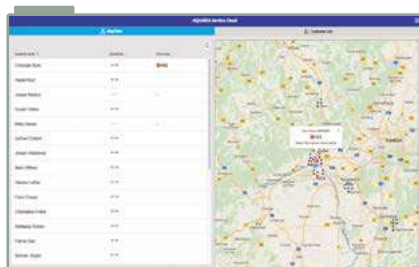

**Home page.**  
Status of connected users at a glance. 2 view options: map view or list view.



**Status tab.**  
Current status of unit with a maximum 28 parameters.

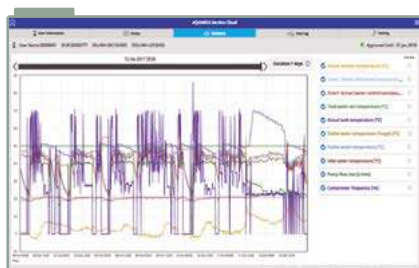

**Statistics tab.**  
Customisable statistics of a maximum of 71 parameters. Available anytime with the information of the last 7 days.



**Settings tab.**  
Most of the user and installer settings can be done remotely.

## Connecting an Aquarea heat pump to the Aquarea Service Cloud

The process can be initiated by the end user or by the installer.  
The end user can select and change the installer's level of control anytime (4 levels).

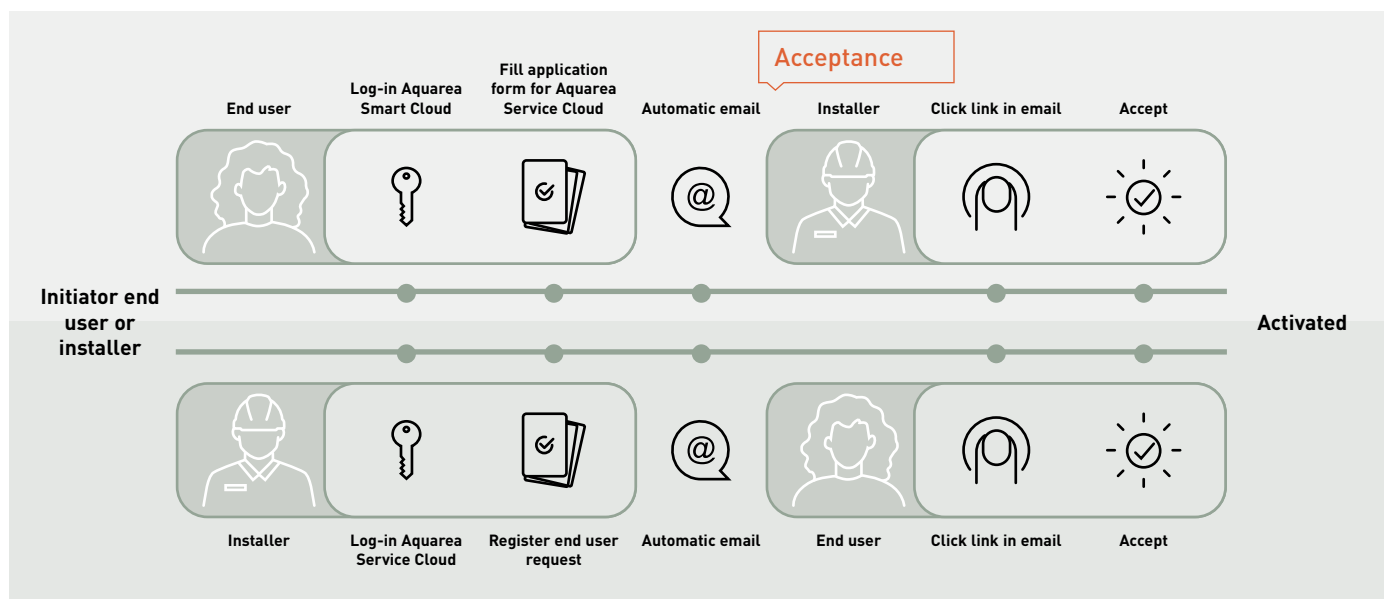

### Requirements:

- 1 | End user: Aquarea Heat Pump connected to the Panasonic Comfort Cloud App
- 2 | Installer/maintenance company: Service ID. Installer registration: <https://aquarea-service.panasonic.com/>

# Aquarea Heat Pumps + tado°, the integrated solution for maximum energy savings and comfort

tado° | Panasonic

Partnership for smart heat pump solutions

tado° X enables room control and smart energy management services.



**Easy installation.**  
Intuitive system selection.  
Offline installation possible.



**Future-proof solution.**  
Further efficiency gains via  
planned software updates.



**Advanced energy savings.**  
With the individual room  
temperature control.



**Reliable and trustworthy.**  
Guaranteed and optimised  
interoperability.

## A smart solution for maintaining the perfect temperature in your home.



**1 tado° Heat Pump Optimizer X.**  
Connecting to Aquarea Heat Pumps and enabling multi-room control and loadshifting.



**tado° app and Balance for Heat Pumps\*.**  
Multi-Room Control, scheduling and energy insights in one market leading app.

\* Requires additional subscription.

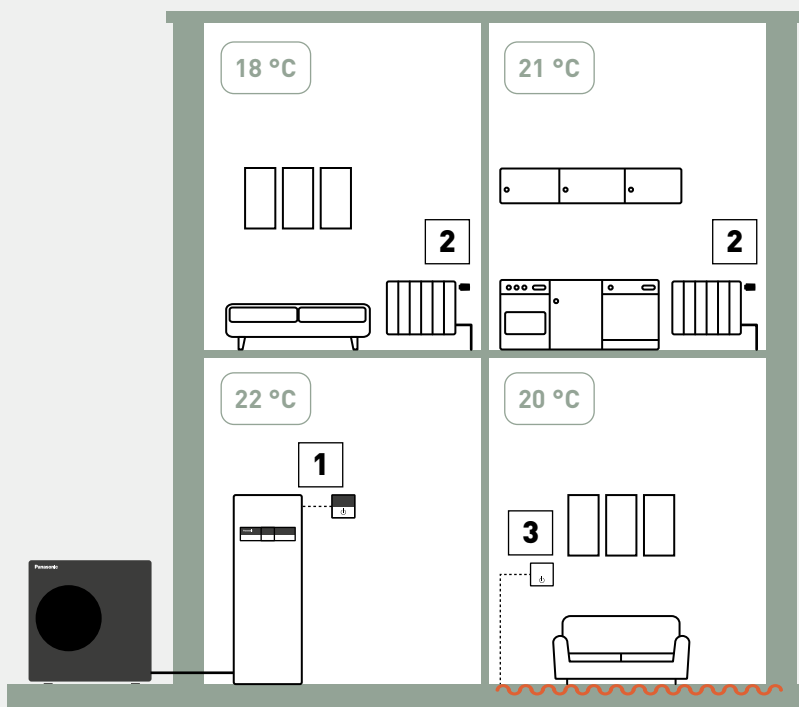

**matter**



**2 tado° Smart Radiator Thermostat X.**  
For radiator control.



**3 tado° Wired Smart Thermostat X.**  
For underfloor heating control.

Save energy with smart heating.

By joining forces, Panasonic and tado° are developing specially tailored auto-control software and new services for Panasonic's Aquarea air to water heat pumps, which provides a variety of customers with differentiating values such as further comfort and energy savings.

+ MORE TADO° OPTIONS IN ACCESSORIES SECTION

tado° X at a glance.



tado° Heat Pump Optimizer X and Balance for Heat Pumps.

Intelligent heating control optimised for Aquarea Heat Pumps, reducing energy use while optimizing comfort. When paired with Smart Thermostats, the heat pump synchronises with each room's needs. The optional Balance subscription maximizes savings by unlocking additional optimisations based on outdoor temperatures, dynamic energy tariffs, and your private PV system.

tado° Room Control.

Save energy, save money, and stay comfortable everywhere. tado° Smart Thermostats simply replace the radiator thermostats or wall thermostats in your home and let you control your heating room by room in one easy-to-use app. Set individual schedules to suit your routines while saving energy by allowing direct feedback from the single rooms to your heat pump. No more overshooting, no more wasting energy.

1) Requires the tado° Heat Pump Optimizer X, the tado° Bridge X or another Thread border router.  
2) Not required with a Heat Pump Optimizer X or another Thread border router.

tado° Room control sets with Heat Pump Optimizer X	
<b>KIT-TSRTXHPOXE</b>	Set of tado° Heat Pump Optimizer X and 1x Smart Radiator Thermostat X
<b>KIT-TSRTX4HPOXE</b>	Set of tado° Heat Pump Optimizer X and 4x tado° Smart Radiator Thermostat X
<b>KIT-TSTXHPOXE</b>	Set of tado° Heat Pump Optimizer X and 1x Smart Thermostat X
<b>KIT-TSTXSRTX2HPOXE</b>	Set of tado° Heat Pump Optimizer X and 1x Smart Thermostat X and 2x Smart Radiator Thermostat X

tado° Room control sets with Bridge X	
<b>PAW-TSRTXB</b>	tado° Smart Radiator Thermostat X with Bridge X
<b>PAW-TSTXB</b>	tado° Smart Thermostat X with Bridge X
<b>PAW-TSTXSRTX2B</b>	Set of 1x Smart Thermostat X, 2x Smart Radiator Thermostat X and 1x Bridge X
tado° X devices	
<b>PAW-THPOXE</b>	tado° Heat Pump Optimizer X (with Europlug)
<b>PAW-TSTX</b>	tado° Smart Thermostat X
<b>PAW-TSRTX</b>	tado° Smart Radiator Thermostat X
<b>PAW-TSRTX4</b>	4x tado° Smart Radiator Thermostat X
<b>PAW-TWTSX</b>	tado° Wireless Temperature Sensor X
<b>PAW-TBX</b>	tado° Bridge X

The tado° app.

Intuitive smart heating technology with Geofencing, Open Window Detection, Multi-Room Control, and offline Smart Schedules. Subscription to additional services, such as Balance for Heat Pumps or tado° Auto-Assist, is available for further energy savings and enhanced transparency over energy consumption.



12-month free subscription to Balance for Heat Pumps\*.

\* With the purchase of PAW-THPOXE or PAW-THPOXUK. This promotion is subject to change without notice.



# Control for Aquarea Heat Pumps

Aquarea Heat Pumps offer a variety of control options.

## Advanced remote controller

**Aquarea remote controller is designed in harmony with the whole system, with optimised user interface and improved features.**

The remote controller can be removed from the indoor unit and installed in the living room.

### K, L and M Series remote controller.

Dual controller system: A dual controller system for independent control of two zones within the home (requires additional remote controller CZ-RTW2 for M Series or CZ-RTW1 for K and L Series).



	K, L and M Series				H and J Series	
	Main controller		Sub controller		Main controller	
Quick menu	✓		✓		✓	
User menu	✓		✓		✓	
Installer / custom menu	✓		—		✓	
Maintenance menu	✓		—		✓	
Error reset	✓		✓		✓	
Internal thermostat	✓ Zone 1	✓ Zone 2	✓ Zone 1	✓ Zone 2	✓ Zone 1	✓ Zone 2

### Installer functions:

System setup, operation setup (including heating / cooling modes,  $\Delta T$  setup), dry concrete mode and cost-effective bivalent mode\*, among others.

\* Only for K, L and M Series.

### End user functions:

Mode selection (including auto, powerful and quiet modes), weekly timer and energy monitoring, among others.

## PCBs for additional functions

**CZ-NS4P: H and J Series.**

**CZ-NS5P: K and L Series.**

**CZ-NS6P: M Series All in One and Bi-bloc.**

**CZ-NS7P: M Series control module.**

The optional PCB enables additional control functions for Aquarea Heat Pumps.

Functions available through the connection of the Optional PCB to the Main PCB:

- 2-zone control, with 2 mixing valves, 2 pumps and 2 room thermostats or sensors
- Control of swimming pool
- Solar thermal control
- External error signal output
- 0-10 V signal for heat pump demand control
- SG Ready <sup>1)</sup>
- Stop compressor by external compressor switch
- Switch heating and cooling by external heat-cool switch

<sup>1)</sup> Aquarea H and J Series heat pumps in combination with the optional PCB CZ-NSP4 hold the SG Ready Label (Smart Grid Ready Label), given by Bundesverband Wärmepumpe (German Heat Pump Association). This Label shows the real capacity of Aquarea to be connected in an intelligent grid control.





# Connectivity

Home Management Systems allow centralized control of all house devices, optimizing operation and costs. Panasonic interfaces support KNX and Modbus protocols. For non-integrated control, Panasonic offers a simple connection to wireless LAN, enabling remote control of heat pumps.

## Control by BMS

**Modbus: PAW-AW-MBS-H <sup>1)</sup> (Intesis) and PAW-AZAW-MBS-M (Airzone).**  
**KNX: PAW-AW-KNX-H <sup>1)</sup> (Intesis) and PAW-AZAW-KNX-1 (Airzone).**

Great flexibility for integration into your KNX / Modbus projects allows fully bi-directional monitoring and control of all the functioning parameters.

- Quick installation
- Direct connection to the unit via CN-CNT connector
- Bidirectional control
- Unit can be controller simultaneously by remote controller and the gateway
- Compatible with H Series onwards
- PAW-AW-MBS-H and PAW-AW-KNX-H don't require external power supply

<sup>1)</sup> Compatible with H and J Series. \* For specific functionality list of each gateway, please check the user's manual.



## NEW Modbus PCB for Aquarea M Series

### CZ-NSMB

The Modbus PCB can be installed in Aquarea M Series units for seamless connectivity.

Compatible with:

- Bi-bloc M Series indoor units: WH-SDC0916M3E5, WH-SDC0916M6E5 and WH-SDC0316M9E8
- Control Module M Series: WH-CME8 and WH-CME8L
- Big Aquarea T-CAP M Series outdoor unit: WH-WXG20ME8, WH-WXG25ME8 and WH-WXG30ME8



## External meter gateway

### PAW-A2W-EXTMETER

- Energy consumption and production from external Modbus RTU meters
- Real values visualized via Aquarea remote controller and Aquarea Smart Cloud
- Compatible with Aquarea K Series onwards



#### Possibility to mix internal calculation and external meters

Configuration	Electricity meter (HP)	Heat meter (heating and cooling)	Heat meter (DHW)
Only external meters	External	External	External
Only external consumption meter	External	Internal calculation	Internal calculation
Only external production meters (2 meters)	Internal calculation	External	External
Only external production meter (single meter for total production)	Internal calculation	External	Internal calculation

#### Functions:

- Configuration via App (iOS and Android™) using Bluetooth®
- Easy to setup thanks to templates for some meters manufacturers
- Configuration can be done before and just send it on commissioning

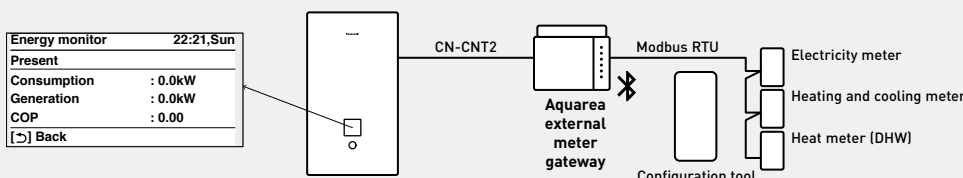

# Cascade manager

Designed for central heating projects, small hotels, supermarkets and restaurants, the cascade manager manages the demand for energy-efficient heating and cooling balancing working hours.



## Up to 10 heat pumps (up to 300 kW)

- Cascade up to 10 units
- Heating and cooling control
- Domestic hot water (DHW) control
- Management up to 75 °C (L or M Series)
- Provides total energy consumption and generation
- All components in one case
- BMS integration

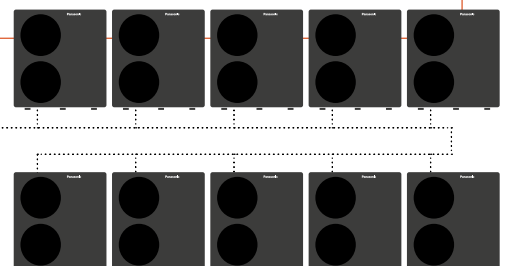

## New cascade manager

### PAW-A2W-CMH-3

Cascade up to 10 heat pumps, getting up to 300 kW, with a large, easy-to-use touch screen display, providing intuitive control.

- Photovoltaics integration (PV optimised algorithm)
- Control of 3 way valves for cooling (2 buffer tanks)
- Heating/cooling 0-10 V demand signal – controls target outlet temperature
- Energy meters compatibility
  - Meters communication with Modbus RTU
  - Pre-configuration of 4 market popular meters
- BMS integration via Modbus TCP
- Working mode: entire system in heating/cooling or DHW by priority



### Compatible with Aquarea Heat Pumps from H Series onwards <sup>1)</sup>.

<sup>1)</sup> Requires 1 CZ-NSMB or 1 PAW-AZAW-MBS-M per each Aquarea Heat Pump.

## New Aquarea Cascade Edge

### PAW-A2W-CME4 and PAW-A2W-CME10

Cascade up to 4 or 10 Aquarea Heat Pumps, also in combination with ECOi-W AQUA chillers and heat pumps, and get up to 750 kW <sup>1)</sup>. Remotely control your units with a local web visualization via smartphone, tablet or PC.

- Local web visualization of the cascade controller
- Easy connection with smartphone, tablet or PC thanks to the Wi-Fi access point on the device
- 2 possible online management solutions:
  - P-Smart Nexus: easy access and global visualization of all your sites
  - Via customer VPN or MyDNS configuration
- Data ownership thanks to local data storage (no cloud storage)
- BMS Integration via BACnet IP
- Smaller buffer tank or smaller capacity unit thanks to 2 possible logic working modes
  - Possibility to combine all the heat pumps between heating/cooling and DHW, providing both simultaneously
  - Entire system in heating/cooling or DHW by priority
- Configuration wizard with default values



### Compatible with Aquarea Heat Pumps from H Series onwards <sup>2)</sup>.

<sup>1)</sup> Maximum capacity combining 1 Aquarea (main) + 9 ECOi-W AQUA-G BLUE 80 kW (sub unit). <sup>2)</sup> Requires 1 CZ-NSMB or 1 PAW-AZAW-MBS-M per each Aquarea Heat Pump.

	PAW-A2W-CMH-3	PAW-A2W-CME4	PAW-A2W-CME10
Cascade up to number of heat pumps	Up to 10	Up to 4	Up to 10
Management of heat demand, balancing working hours	✓	✓	✓
Integration of photovoltaics (PV optimised algorithm)	✓	—	—
Connectable buffer tank	2 tanks	1 tank	1 tank
Heating/cooling 0-10 V demand signal	✓	—	—
BMS integration	Modbus TCP	BACnet IP	BACnet IP
Built-in touch screen display	✓	—	—
Management via smartphone, tablet or PC	—	✓	✓
Remote monitoring via P-Smart Edge	—	✓	✓
Multi-site control via P-Smart Nexus	—	✓	✓
Data statistics visualization	—	✓	✓

# P-Smart Edge for Aquarea Cascade Edge

Complete and remote centralized control of your Aquarea cascade system.



**P-Smart Edge.**

Control and monitoring solution for Aquarea cascade systems wherever you are. In a simple click, configure and receive status updates of all your units.

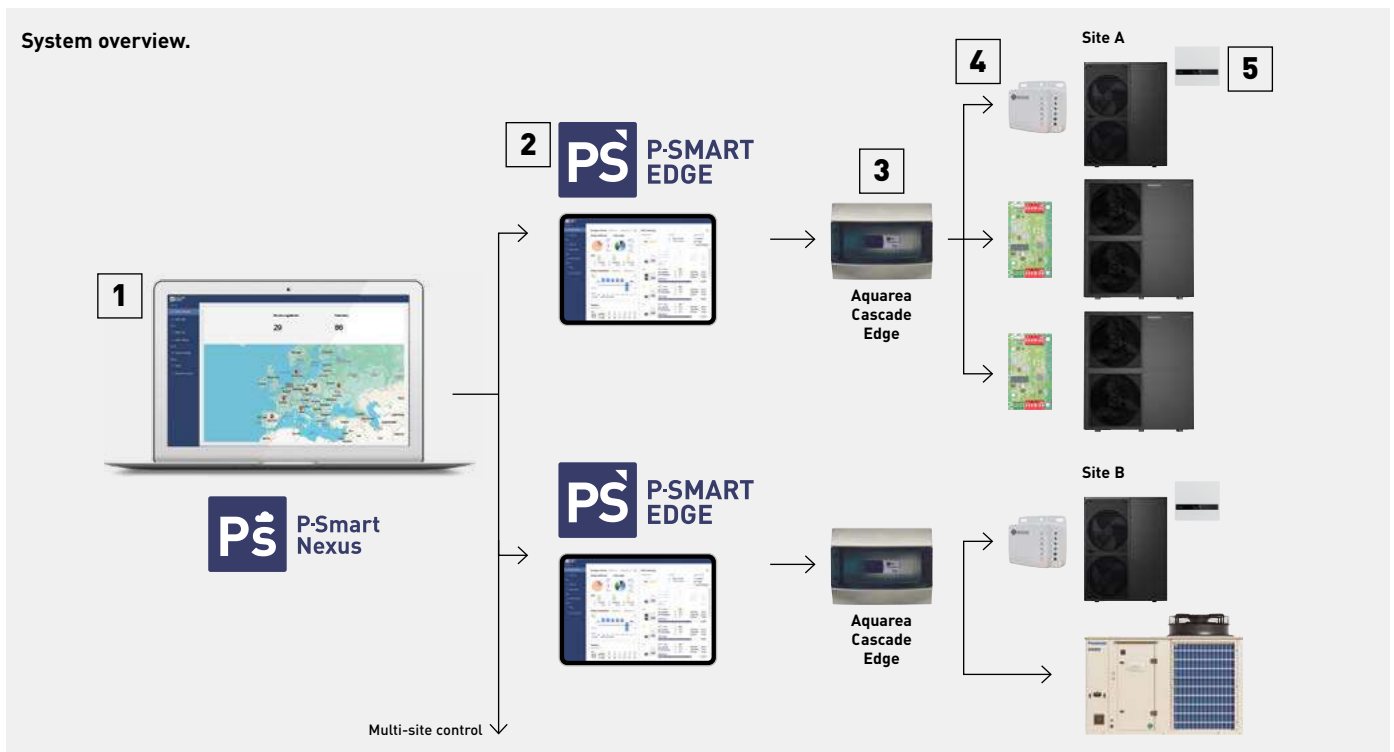

**1 P-Smart Nexus.**  
Smart multi-site control which allows a remote global supervision of all your sites. Control your different installations wherever you are, with easy on-site network setup.



**2 P-Smart Edge.**  
Control and monitoring solution for Aquarea cascade systems, even outside your installation site.



**3 Aquarea Cascade Edge.**  
PAW-A2W-CME4 and PAW-A2W-CME10.



**4 Modbus interface.**  
Requires 1 CZ-NSMB or 1 PAW-AZAW-MBS-M per each Aquarea Heat Pump.



**5 Aquarea cascade system.**  
Main unit: control module or Bi-bloc mandatory + optional PCB.  
Sub units: remote controller needed. Possibility of combination with other Panasonic commercial products (ECOi-W AQUA chillers and heat pumps).

\* Check availability for chiller connection.

**Advantages**



**Powerful remote management with user-friendly interface.**

- Simple and intuitive home screen with: Plant overview, energy overview, DHW status and buffer and zone list
- Alarm status and history
- 3 different user profiles: facility manager, installer and maintenance
- Online visualization, no installation of any specific software is required



**Remote configuration of the technical parameters.**  
Possible configuration of:

- Installation settings
- Sterilisation configuration (schedule)
- Outdoor units silence mode (schedule)
- Bivalent
- SG Ready
- COP ranking



**Historical system data.**

- Graphs and data showing the energy overview related to periods of 7 days or 8 hours
- Data stored for up to 2 years



**P-Smart Nexus: smart multi-site remote management.**

- Remote global supervision of all your sites in one place
- 24/7 control of all the installations
- Easy connection to Aquarea Cascade Edge without special on-site network setup
- 3-year subscription from the start-up included
- Online visualization, no installation of any specific software is required

Note: User interface design may vary.

# How Panasonic contributes to Nearly Zero Energy Buildings (nZEB)

Our expertise gained over the years has helped to launch a range of products that contribute to a more carbon-free society.

## Panasonic is committed to develop products with greater energy efficiency.

Highly efficient Panasonic solutions can help to significantly reduce the energy consumption of the house, at the same time a high level of comfort and good indoor air quality are kept.

- Aquarea High performance heat pump for heating, cooling and domestic hot water production
- Aquarea Smart Cloud, for energy monitoring
- Heat recovery ventilation system
- PV panels to produce renewable energy on-site



## Aquarea Heat Pumps and the ventilation unit with heat recovery certified as Passive House Component

Aquarea High Performance K and L Series heat pumps and the residential ventilation units have been certified by the Passive House Institute (PHI) as Passive House Component. This certification ensures highly energy efficient components according to international criteria for respective thermal performance, comfort and indoor air quality.

Certified models can be checked under the certification section of <https://database.passivehouse.com>.



### H3 Grande Passive House, Poland.

When looking for a energy-efficient heating solution, Polish construction company Procyon selected a 5 kW Panasonic Aquarea High Performance heat pump for its passive house project, H3 Grande. Procyon found this solution reduced annual heating expenses by almost half compared to an oil-based system, or by 10% in comparison to natural gas.

H3 Grande is a 175 m<sup>2</sup> detached house certified by the Passive House Institute (PHI) in Darmstadt. It is designed to minimise energy losses while incorporating an attractive, yet simple aesthetic. The building's shape, interior design and pitched roof contribute to the energy balance of the house, while large south-facing windows and wall insulation provide passive thermal comfort by retaining heat. The building has very low heating demand of approximately 15 W/m<sup>2</sup> and is designed to minimise energy.

## Aquarea and PV integration

Aquarea Heat Pumps are designed with the future in mind. Thanks to the integration of the Aquarea Heat Pumps with PV, the demand or power consumption for heating, cooling and domestic hot water production is adapted to the PV production.

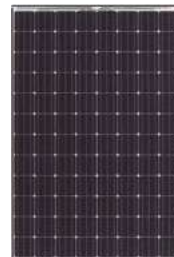

**Savings on heat pump running costs.**



**Reduced primary energy consumption.**



**Lower CO<sub>2</sub> emissions.**



**Maximised comfort.**

### Aquarea Heat Pumps can be integrated with PV thanks to the optional PCB <sup>1)</sup>

With the SG Ready function, the Aquarea Heat Pumps will be able to store thermal energy during periods where the electricity produced is higher than the demand in the house. These are some examples:

1. Store DHW at higher temperature. Aquarea M and L Series can produce DHW at 65 °C up to 40% more tap water
2. Heat or cool the house to maintain a comfortable temperature continuously. This requires less energy during the off-peak production hours
3. Store thermal energy in a buffer tank

1) CZ-NS\*P. Check the model reference by Series in the control for Aquarea Heat Pumps section.

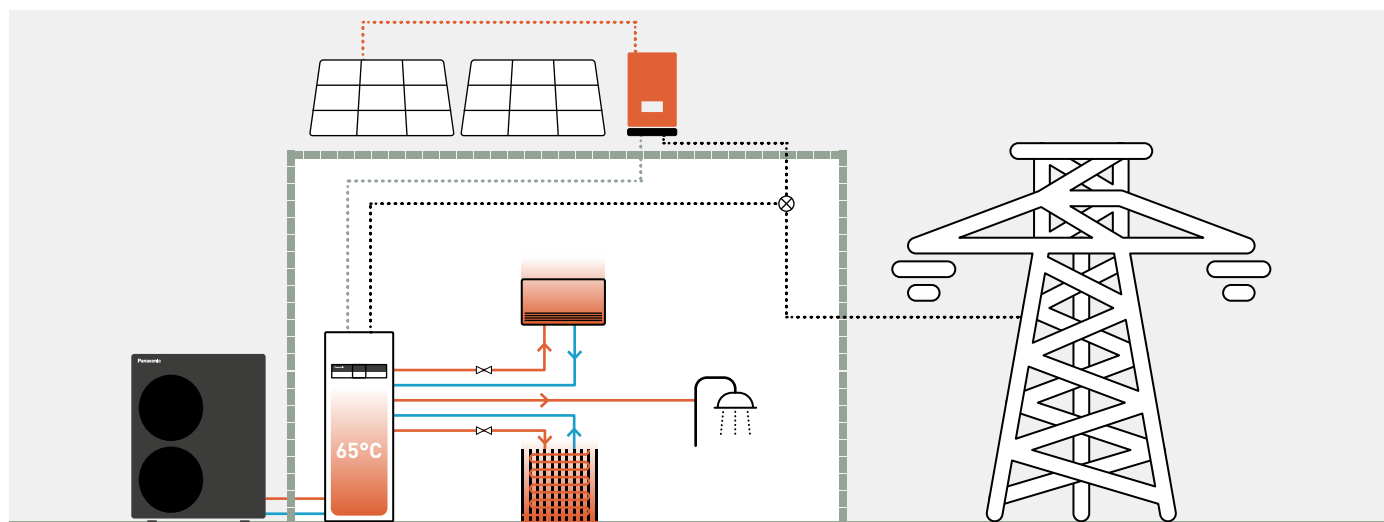

### Turning a family home into an energy-neutral house.

Installer Sinne Technyk chose the Aquarea T-CAP heat pump in combination with HIT KURO photovoltaic panels for a house in Oudemirdum in Friesland, the Netherlands. With this combination, the household enjoys energy-neutral and free heating and hot water, as well as a more comfortable indoor climate. "The aim was to create an energy-neutral house and to reduce gas consumption to zero," explains Leo van der Molen of Sinne Technyk. "This makes a heat pump an interesting option". With the comfort of customers and neighbours in mind, a silent Aquarea T-CAP heat pump was chosen, powered by 24 Panasonic HIT KURO solar panels of 325 Wp each.

# Aquarea design tools to make your life easier

Discover the suite of Aquarea design tools crafted to streamline your professional workflow on Aquarea projects. These resources are designed to make your planning process more efficient and effective.



## Aquarea Designer – online tool

With Panasonic's Aquarea Designer - online tool, projects can be developed simply and easily. The newly developed air to water design tool is optimised to help HVAC professionals easily identify the most appropriate Aquarea air-to-water heat pump for a particular application, to calculate the savings compared to other heat sources and to calculate CO<sub>2</sub> emissions very quickly. The system can produce a Heat Pump Design Report which includes:

- Customer and general project information
- Heating system specific data
- Heat pump dimensioning, including information about the chosen Panasonic heat pump
- Calculated energy demand and performance factors
- CO<sub>2</sub> savings by the different energy sources
- Comparison of yearly operational or economic costs (optional)



All the support tools are available in Panasonic PRO Club ([www.panasonicproclub.com](http://www.panasonicproclub.com)).

Among many others, these are the main tools for the design of Aquarea projects.





## Hydraulic scheme generator

The Aquarea Hydraulic Scheme Generator (HSG) allows users to select a hydraulic schematic according to their installation requirements. This will be accompanied by the relevant electrical connection schematic and component list.

The latest features and upgrades include:

- A modern user interface
- Accessory model choice selection
- Expanded buffer tank options
- Additional refrigerant and hydraulic specification details

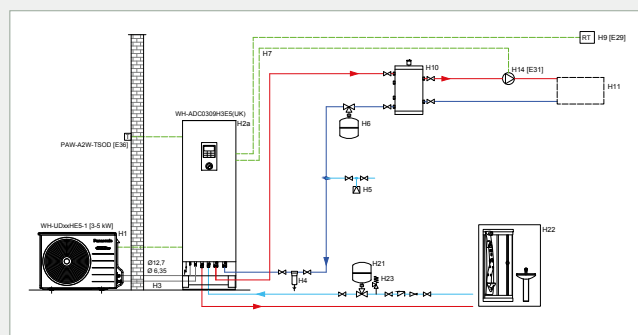
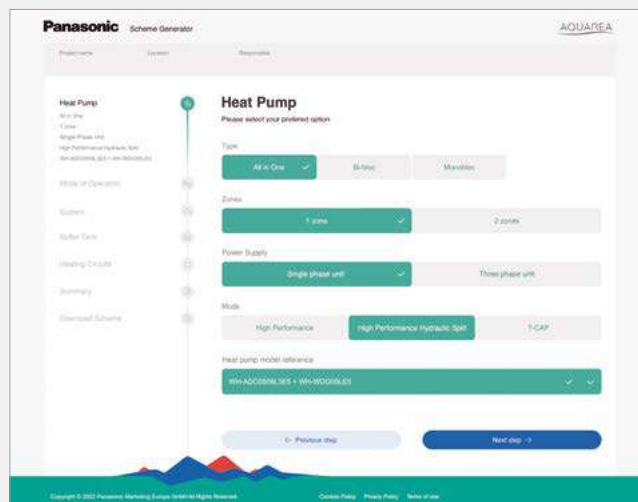

## Vent PRO

From selecting the right ventilation unit to planning the air distribution system and choosing the appropriate components, the Vent PRO guides you through every step to ensure the optimal solution for your project.

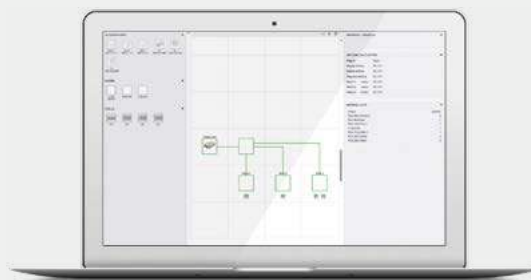

## Heating demand calculator

This software can quickly and easily determine the heating requirements for the rooms in a project. The Heating demand calculator will help determine approximately how much power is needed to heat each room individually. The result in kilowatts will help you choose the space heater best suited to your needs.

## CAD images and spec texts

In order to add value in the design of projects, Panasonic has a wide library of 2D CAD, BIM objects (Building Information Modeling) and Spec texts to be used in Revit.

Try the new Panasonic Augmented Reality projector.



Helping you to find the Aquarea Heat Pumps for your home in just a few clicks!



# Aquarea Hydraulic

Aquarea High Performance	5 kW	7 kW	9 kW	12 kW	16 kW
<p>P. 70 , 72</p> <p><b>All in One</b> - R290 1ph - 3ph</p> 	 <p><b>NEW</b> WH-ADC0509L3E51 <sup>1)</sup> WH-ADC0509L3E5AN1 <sup>1)</sup></p> <p>WH-ADC0509L3E5 <sup>3)</sup> WH-ADC0509L3E5B WH-ADC0509L3E5AN <sup>3)</sup> WH-WDG05LE5</p>	 <p><b>NEW</b> WH-ADC0509L3E51 <sup>1)</sup> WH-ADC0509L3E5AN1 <sup>1)</sup></p> <p>WH-ADC0509L3E5 <sup>3)</sup> WH-ADC0509L3E5B WH-ADC0509L3E5AN <sup>3)</sup> WH-WDG07LE5</p>	 <p><b>NEW</b> WH-ADC0509L3E51 <sup>1)</sup> WH-ADC0509L3E5AN1 <sup>1)</sup></p> <p>WH-ADC0509L3E5 <sup>3)</sup> WH-ADC0509L3E5B WH-ADC0509L3E5AN <sup>3)</sup> WH-WDG09LE5</p>	 <p><b>NEW</b> WH-ADC0916M3E51 <sup>2)</sup> WH-ADC0916M3E5AN1 <sup>2)</sup> WH-ADC0916M3E52 <sup>3)</sup> WH-ADC0916M3E5AN2 WH-ADC0916M3E53 <sup>3)</sup> WH-ADC0916M3E5AN3 WH-ADC0316M9E82 WH-ADC0316M9E8AN2 WH-ADC0316M9E83 WH-ADC0316M9E8AN3 WH-WDG12ME5 <sup>2)</sup></p>	 <p><b>NEW</b> WH-ADC0916M3E51 <sup>2)</sup> WH-ADC0916M3E5AN1 <sup>2)</sup> WH-ADC0916M3E52 <sup>3)</sup> WH-ADC0916M3E5AN2 WH-ADC0916M3E53 <sup>3)</sup> WH-ADC0916M3E5AN3 WH-ADC0316M9E82 WH-ADC0316M9E8AN2 WH-ADC0316M9E83 WH-ADC0316M9E8AN3 WH-WDG16ME5 <sup>2)</sup></p>
<p>P. 70 , 72</p> <p><b>Bi-bloc</b> - R290 1ph - 3ph</p> 	 <p>WH-SDC0509L3E5 <sup>3)</sup> WH-WDG05LE5</p>	 <p>WH-SDC0509L3E5 <sup>3)</sup> WH-WDG07LE5</p>	 <p>WH-SDC0509L3E5 <sup>3)</sup> WH-WDG09LE5</p>	 <p><b>NEW</b> WH-SDC0916M3E5 <sup>1)3)</sup> WH-SDC0316M9E8 WH-WDG12ME5 <sup>2)</sup></p>	 <p><b>NEW</b> WH-SDC0916M3E5 <sup>1)3)</sup> WH-SDC0316M9E8 WH-WDG16ME5 <sup>2)</sup></p>
<p>P. 72</p> <p><b>Control module</b> - R290 1ph - 3ph</p> 				 <p><b>NEW</b> WH-CME5 WH-CME8 WH-WDG12ME5 <sup>2)</sup></p>	 <p><b>NEW</b> WH-CME5 WH-CME8 WH-WDG16ME5 <sup>2)</sup></p>
<p>P. 72</p> <p><b>Stand-alone</b> - R290 <sup>4)</sup> 1ph</p> 				 <p><b>NEW</b> WH-WDG12ME5 <sup>2)</sup></p>	 <p><b>NEW</b> WH-WDG16ME5 <sup>2)</sup></p>
<p>P. 74</p> <p><b>Mono-bloc</b> - R32 1ph</p>	 <p>WH-MDC05J3E5</p>	 <p>WH-MDC07J3E5</p>	 <p>WH-MDC09J3E5</p>		

Models with R290 refrigerant. Models with R32 refrigerant.  
 1) Available Spring 2025. 2) Available in Autumn 2025. 3) Also available with other backup heater capacities. 4) Requires CZ-RTW2TAW1C.  
 WH-\_\_E5 1ph // WH-\_\_E8 3ph.WH-\_\_E5 1ph // WH-\_\_E8 3ph.

Aquarea T-CAP	9 kW	12 kW	16 kW	20 kW	25 kW	30 kW
<p>P. 76 , 78</p> <p> R290</p> <p><b>All in One</b> - R290 1ph - 3ph</p>	 <p><b>NEW</b> WH-ADC0916M3E51 <sup>2)</sup> WH-ADC0916M3E5AN1 <sup>2)</sup> WH-ADC0916M3E52 <sup>3)</sup> WH-ADC0916M3E5AN2 WH-ADC0916M3E53 <sup>3)</sup> WH-ADC0916M3E5AN3 WH-ADC0316M9E82 WH-ADC0316M9E8AN2 WH-ADC0316M9E83 WH-ADC0316M9E8AN3 WH-WXG09ME5 WH-WXG09ME8</p>	 <p><b>NEW</b> WH-ADC0916M3E51 <sup>2)</sup> WH-ADC0916M3E5AN1 <sup>2)</sup> WH-ADC0916M3E52 <sup>3)</sup> WH-ADC0916M3E5AN2 WH-ADC0916M3E53 <sup>3)</sup> WH-ADC0916M3E5AN3 WH-ADC0316M9E82 WH-ADC0316M9E8AN2 WH-ADC0316M9E83 WH-ADC0316M9E8AN3 WH-WXG12ME5 WH-WXG12ME8</p>	 <p><b>NEW</b> WH-ADC0316M9E82 WH-ADC0316M9E8AN2 WH-ADC0316M9E83 WH-ADC0316M9E8AN3 WH-WXG16ME8</p>			
<p>P. 76 , 78</p> <p> R290</p> <p><b>Bi-bloc</b> - R290 1ph - 3ph</p>	 <p><b>NEW</b> WH-SDC0916M3E5 <sup>3)</sup> WH-SDC0316M9E8 WH-WXG09ME5 WH-WXG09ME8</p>	 <p><b>NEW</b> WH-SDC0916M3E5 <sup>3)</sup> WH-SDC0316M9E8 WH-WXG12ME5 WH-WXG12ME8</p>	 <p><b>NEW</b> WH-SDC0316M9E8 WH-WXG16ME8</p>			
<p>P. 76 , 78</p> <p> R290</p> <p><b>Control module</b> - R290 1ph - 3ph</p>	 <p><b>NEW</b> WH-CME5 WH-CME8 WH-WXG09ME5 WH-WXG09ME8</p>	 <p><b>NEW</b> WH-CME5 WH-CME8 WH-WXG12ME5 WH-WXG12ME8</p>	 <p><b>NEW</b> WH-CME8 WH-WXG16ME8</p>	 <p><b>NEW</b> WH-CME8L WH-WXG20ME8</p>	 <p><b>NEW</b> WH-CME8L WH-WXG25ME8</p>	 <p><b>NEW</b> WH-CME8L WH-WXG30ME8</p>
<p>P. 76 , 78</p> <p> R290</p> <p><b>Stand-alone</b> - R290 <sup>4)</sup> 1ph - 3ph</p>	 <p><b>NEW</b> WH-WXG09ME5 WH-WXG09ME8</p>	 <p><b>NEW</b> WH-WXG12ME5 WH-WXG12ME8</p>	 <p><b>NEW</b> WH-WXG16ME8</p>	 <p><b>NEW</b> WH-WXG20ME8</p>	 <p><b>NEW</b> WH-WXG25ME8</p>	 <p><b>NEW</b> WH-WXG30ME8</p>
<p>P. 80</p> <p><b>Mono-bloc</b> - R32 1ph - 3ph</p>	 <p>WH-MXC09J3E5 WH-MXC09J3E8</p>	 <p>WH-MXC12J6E5 WH-MXC12J9E8</p>	 <p>WH-MXC16J9E8</p>			

Models with R290 refrigerant. Models with R32 refrigerant.

1) Available Spring 2025. 2) Available in Autumn 2025. 3) Also available with other backup heater capacities. 4) Requires CZ-RTW2TAW1C.  
WH-\_\_E5 1ph // WH-\_\_E8 3ph.

# Aquarea Split

## Aquarea EcoFlex

8 kW

P. 81 1ph



WH-ADF0309J3E5CM  
S-71WF3E  
CU-2WZ71YBE5

## Aquarea High Performance

3 kW

5 kW

7 kW

9 kW

12 kW

16 kW

P. 82, 83, 84, 85, 86, 87, 88, 89

All in One  
· R32  
1ph - 3ph



WH-ADC0309K3E5<sup>1)</sup>  
WH-ADC0309K3E5B  
WH-ADC0309K3E5AN<sup>1)</sup>  
WH-UDZ03KE5



WH-ADC0309K3E5<sup>1)</sup>  
WH-ADC0309K3E5B  
WH-ADC0309K3E5AN<sup>1)</sup>  
WH-UDZ05KE5



WH-ADC0309K3E5<sup>1)</sup>  
WH-ADC0309K3E5B  
WH-ADC0309K3E5AN<sup>1)</sup>  
WH-UDZ07KE5



WH-ADC0309K3E5<sup>1)</sup>  
WH-ADC0309K3E5B  
WH-ADC0309K3E5AN<sup>1)</sup>  
WH-UDZ09KE5

**NEW**  
WH-ADC0912K9E8  
WH-ADC0912K9E8AN  
WH-ADC0912K9E83  
WH-ADC0912K9E8AN3  
WH-UDZ09KE8



WH-ADC0912K6E5  
WH-ADC0912K6E5AN  
WH-ADC0912K6E53  
WH-ADC0912K6E5AN3  
WH-UDZ12KE5

**NEW**  
WH-ADC0912K9E8  
WH-ADC0912K9E8AN  
WH-ADC0912K9E83  
WH-ADC0912K9E8AN3  
WH-UDZ12KE8



**NEW**  
WH-ADC16K9E8  
WH-ADC16K9E8AN  
WH-ADC16K9E83  
WH-ADC16K9E8AN3  
WH-UDZ16KE8

WH-ADC16K6E5  
WH-ADC16K6E5AN  
WH-ADC16K6E53  
WH-UDZ16KE5

P. 90, 91

Bi-bloc  
· R32  
1ph - 3ph



WH-SDC0309K3E5<sup>1)</sup>  
WH-UDZ03KE5



WH-SDC0309K3E5<sup>1)</sup>  
WH-UDZ05KE5



WH-SDC0309K3E5<sup>1)</sup>  
WH-UDZ07KE5



WH-SDC0309K3E5<sup>1)</sup>  
WH-UDZ09KE5

**NEW**  
WH-SDC09K3E8<sup>1)</sup>  
WH-UDZ09KE8



WH-SDC12K6E5  
WH-UDZ12KE5

**NEW**  
WH-SDC12K9E8  
WH-UDZ12KE8



**NEW**  
WH-SDC16K9E8  
WH-UDZ16KE8

Models with R32 refrigerant.

1) Also available with other backup heater capacities.  
WH-\_\_E5 1ph // WH-\_\_E8 3ph.

# Aquarea DHW Heat Pump

## Aquarea DHW Heat Pump · R290

100 L

150 L

200 L

260 L

P. 122



1ph



P-DHW100AE5



P-DHW150AE5



P-DHW200AE5  
P-DHW200CAE5



P-DHW260AE5  
P-DHW260CAE5



Check all our certified heat pumps on:  
[www.heatpumpkeymark.com](http://www.heatpumpkeymark.com)

Aquarea T-CAP		9 kW	12 kW	16 kW
P. 93, 94, 95, 96	<b>All in One</b> · R32 1ph - 3ph			
		WH-ADC0912K6E53 WH-ADC0912K6E5AN3 WH-UXZ09KE5  WH-ADC0912K9E83 WH-ADC0912K9E8AN3 WH-UXZ09KE8	WH-ADC0912K6E53 WH-ADC0912K6E5AN3 WH-UXZ12KE5  WH-ADC0912K9E83 WH-ADC0912K9E8AN3 WH-UXZ12KE8	WH-ADC16K9E83 WH-ADC16K9E8AN3 WH-UXZ16KE8
P. 98	<b>All in One</b> · R410A 3ph			
		WH-ADC0916H9E8 WH-UQ09HE8	WH-ADC0916H9E8 WH-UQ12HE8	WH-ADC0916H9E8 WH-UQ16HE8
P. 97	<b>Bi-bloc</b> · R32 1ph - 3ph			
		WH-SXC09K3E5 <sup>1)</sup> WH-UXZ09KE5  WH-SXC09K3E8 WH-UXZ09KE8	WH-SXC12K6E5 WH-UXZ12KE5  WH-SXC12K9E8 WH-UXZ12KE8	WH-SXC16K9E8 WH-UXZ16KE8
P. 99	<b>Bi-bloc</b> · R410A 3ph			
		WH-SQC09H3E8 WH-UQ09HE8	WH-SQC12H9E8 WH-UQ12HE8	WH-SQC16H9E8 WH-UQ16HE8

Models with R32 refrigerant. Models with R410A refrigerant.

1) Also available with other backup heater capacities.

WH-\_\_E5 1ph // WH-\_\_E8 3ph.

## Aquarea High Performance Hydraulic L Series. Single phase - R290

**Natural refrigerant R290 with GWP 0,02.**

**Energy efficiency:** A+++ in heating at 35 °C.

**Flexibility:** Hydraulic connection between indoor and outdoor / Built-in magnetic water filter.

**Comfort:** Operation without backup heating at -25 °C / 75 °C water outlet temperature maximum at -10 °C outside temperature / 55 °C hot water even at -25 °C outside temperature.



\* For All in One.

Combination table					Outdoor unit				
Indoor unit					Heating capacity				
					Single phase (power to indoor)				
					5,0 kW	7,0 kW	9,0 kW		
					WH-WDG05LE5	WH-WDG07LE5	WH-WDG09LE5		
Hydraulic All in One	1ph	DHW tank	Backup heater capacity	2 zones	Electrical anode				
		120 L	3 kW	—	—	WH-ADC0509L3E51	✓	✓	✓
		120 L	3 kW	—	✓	WH-ADC0509L3E5AN1	✓	✓	✓
		185 L	3 kW	—	—	WH-ADC0509L3E5	✓	✓	✓
		185 L	3 kW	—	✓	WH-ADC0509L3E5AN	✓	✓	✓
		185 L	6 kW	—	—	WH-ADC0509L6E5	✓	✓	✓
		185 L	6 kW	—	✓	WH-ADC0509L6E5AN	✓	✓	✓
Hydraulic Bi-bloc	1ph	—	3 kW	—	—	WH-SDC0509L3E5	✓	✓	✓
		—	6 kW	—	—	WH-SDC0509L6E5	✓	✓	✓

Outdoor unit		WH-WDG05LE5	WH-WDG07LE5	WH-WDG09LE5	
Heating capacity / COP (A +7 °C, W 35 °C)	kW / COP	5,00/5,05	7,00/4,93	9,00/4,55	
Heating capacity / COP (A +7 °C, W 55 °C)	kW / COP	5,00/3,07	7,00/2,98	8,90/3,03	
Heating capacity / COP (A +2 °C, W 35 °C)	kW / COP	5,00/3,52	6,85/3,43	7,00/3,41	
Heating capacity / COP (A +2 °C, W 55 °C)	kW / COP	5,00/2,34	6,25/2,34	7,00/2,41	
Heating capacity / COP (A -7 °C, W 35 °C)	kW / COP	5,00/3,01	5,80/3,01	7,00/2,80	
Heating capacity / COP (A -7 °C, W 55 °C)	kW / COP	5,00/2,12	5,80/2,12	7,00/2,13	
Cooling capacity / EER (A 35 °C, W 7 °C)	kW / EER	5,00/3,23	7,00/3,03	8,20/2,82	
Cooling capacity / EER (A 35 °C, W 18 °C)	kW / EER	5,00/5,00	7,00/4,73	9,00/4,19	
Heating average climate (W 35 °C / W 55 °C)	Seasonal energy efficiency	SCOP (η <sub>s</sub> %)	5,06/3,63(200/142)	4,96/3,62(195/142)	4,84/3,67(190/144)
	Energy class <sup>1)</sup>	A+++ to D	A+++ / A++	A+++ / A++	A+++ / A++
Heating warm climate (W 35 °C / W 55 °C)	Seasonal energy efficiency	SCOP (η <sub>s</sub> %)	6,00/4,27(237/168)	6,31/4,52(249/178)	6,44/4,50(255/177)
	Energy class <sup>1)</sup>	A+++ to D	A+++ / A+++	A+++ / A+++	A+++ / A+++
Heating cold climate (W 35 °C / W 55 °C)	Seasonal energy efficiency	SCOP (η <sub>s</sub> %)	4,25/3,28(167/128)	4,25/3,29(167/129)	4,31/3,33(170/130)
	Energy class <sup>1)</sup>	A+++ to D	A++ / A++	A++ / A++	A++ / A++
Sound power <sup>2)</sup>	Heat	dB(A)	52	53	54
Dimension / Net weight	H x W x D	mm / kg	996 x 980 x 430 / 98	996 x 980 x 430 / 98	996 x 980 x 430 / 97
Refrigerant (R290) / CO <sub>2</sub> Eq.		kg / T	0,96/0,00002	0,96/0,00002	1,00/0,00002
Operating range - outdoor ambient	Heat	°C	-25 ~ +35	-25 ~ +35	-25 ~ +35
	Cool	°C	+10 ~ +43	+10 ~ +43	+10 ~ +43
Water outlet	Heat / Cool	°C	20 ~ 75 / 5 ~ 20	20 ~ 75 / 5 ~ 20	20 ~ 75 / 5 ~ 20

1) Scale from A+++ to D. 2) Sound power level in accordance to EN 12102 under conditions of the EN14825 (part load). \* EER and COP calculation is based in accordance to EN 14511.



DHW A+: For All in One. INTERNET CONTROL: Wi-Fi adapter included.

## All in One:

**Energy efficiency:** A+ in DHW / DHW up to 65 °C without heater / Stainless steel DHW tank with U-Vacua™ insulation panel / DHW COP up to 3,60.

**Flexibility:** Built-in 2 zone kit (for 2 zones models) / Installation in harsh water conditions (for models with Electrical Anode).

**Control:** Optimised user interface and improved features (2 zone control, bivalent control).

**Connectivity:** Wi-Fi adapter included.

Indoor unit			WH-ADC0509L3E51*	WH-ADC0509L3E5	WH-ADC0509L6E5			
<b>Indoor unit 2 zones</b>			—	WH-ADC0509L3E5B	—			
<b>Indoor unit with Electrical Anode</b>			WH-ADC0509L3E5AN1*	WH-ADC0509L3E5AN	WH-ADC0509L6E5AN			
Sound pressure	Heat / Cool	dB(A)	31/31	28/28	28/28			
Dimension	HxWxD	mm	1293x599x602	1642x599x602	1642x599x602			
Net weight / 2 zones model		kg	79/—	93/101	94/—			
Water pipe connector	Room	Inch	1¼	1¼	1¼			
	Shower	Inch	¾	¾	¾			
A class pump	Number of speeds		Variable speed	Variable speed	Variable speed			
	Input power (Min/Max)	W	30/145	30/145	30/145			
Heating water flow (ΔT=5 K, 35 °C)		L/min	14,3	14,3	25,8			
Water volume		L	120	185	185			
Maximum DHW temperature		°C	65	65	65			
Material inside tank			Stainless steel	Stainless steel	Stainless steel			
Water pipe connector (indoor / outdoor units)		Inch	1/1	1/1	1/1			
Pipe length range standard / maximum		m	5/30	5/30	5/30			
Elevation difference (in / out)		m	10	10	10			
Electric backup heater		kW	3,00	3,00	6,00			
Recommended fuse, supply 1 / 2 <sup>1)</sup>		A	25/16	25/16	25/30			
Recommended minimum cable size, supply 1 / 2 <sup>1)</sup>		mm <sup>2</sup>	3x2,5/3x1,5	3x2,5/3x1,5	3x2,5/3x4,0			
<b>Domestic Hot Water energy efficiency</b>			<b>120 L</b>	<b>185 L</b>	<b>120 L</b>	<b>185 L</b>	<b>120 L</b>	<b>185 L</b>
<b>Indoor unit (I)</b>	<b>WH-</b>		ADC0509L3E51	ADC0509L3E5	ADC0509L3E51	ADC0509L3E5	ADC0509L3E51	ADC0509L3E5
			ADC0509L3E5AN1	ADC0509L3E5AN	ADC0509L3E5AN1	ADC0509L3E5AN	ADC0509L3E5AN1	ADC0509L3E5AN
			ADC0509L3E5B		ADC0509L3E5B		ADC0509L3E5B	
			ADC0509L6E5		ADC0509L6E5		ADC0509L6E5	
			ADC0509L6E5AN		ADC0509L6E5AN		ADC0509L6E5AN	
<b>Outdoor unit</b>			<b>WH-WDG05LE5</b>	<b>WH-WDG07LE5</b>	<b>WH-WDG09LE5</b>			
Tapping profile according EN16147			M	L	M	L	M	L
DHW tank ERP efficiency average / warm / cold <sup>2)</sup>	A+ to F		A+/A++/A	A+/A+/A	A+/A++/A	A+/A+/A	A+/A++/A	A+/A+/A
DHW tank ERP average climate η / COPdHW	ηwh %/COPdHW		115/2,88	148/3,61	115/2,88	148/3,61	115/2,88	148/3,61
DHW tank ERP warm climate η / COPdHW	ηwh %/COPdHW		134/3,35	160/4,00	134/3,35	160/4,00	134/3,35	160/4,00
DHW tank ERP cold climate η / COPdHW	ηwh %/COPdHW		90/2,26	112/2,80	90/2,26	112/2,80	90/2,26	112/2,80

1) Check local regulations. 2) Scale from A+ to F. \* Available Spring 2025. \*\* This product is designed to comply with the European drinking water standard (EU) 2020/2184. The lifespan of the product is not guaranteed in the case of the use of groundwater, such as spring water or well water, the use of tap water when salt or other impurities are contained, nor in areas of acidic water quality. Maintenance and warranty costs related to these cases are the customer's responsibility.

## Bi-bloc:

**Flexibility:** Flexible choice of DHW tank size.

**Control:** Optimised user interface and improved features (2 zone control, bivalent control).

**Connectivity:** Wi-Fi adapter included.

Indoor unit			WH-SDC0509L3E5	WH-SDC0509L6E5
Sound pressure	Heat / Cool	dB(A)	28/28	28/28
Dimension / Net weight	HxWxD	mm	892x500x348 / 33	892x500x348 / 33
Water pipe connector	Room	Inch	R1¼	R1¼
A class pump	Number of speeds		Variable speed	Variable speed
	Input power (Min/Max)	W	30/145	30/145
Heating water flow (ΔT=5 K, 35 °C)		L/min	14,3	20,1
Water pipe connector (indoor / outdoor units)		Inch	1/1	1/1
Pipe length range standard / maximum		m	5/30	5/30
Elevation difference (in / out)		m	10	10
Electric backup heater		kW	3,00	6,00
Recommended fuse, supply 1 / 2 <sup>1)</sup>		A	25/16	25/30
Recommended minimum cable size, supply 1 / 2 <sup>1)</sup>		mm <sup>2</sup>	3x2,5/3x1,5	3x2,5/3x4,0

1) Check local regulations. \* This product is designed to comply with the European drinking water standard (EU) 2020/2184. The lifespan of the product is not guaranteed in the case of the use of groundwater, such as spring water or well water, the use of tap water when salt or other impurities are contained, nor in areas of acidic water quality. Maintenance and warranty costs related to these cases are the customer's responsibility.

Common accessories	
<b>CZ-RTW1</b>	Optional remote controller for 2 zone control. K and L Series
<b>CZ-NS5P</b>	PCB for advanced functions
<b>PAW-A2W-RTWIRED</b>	Room thermostat
<b>PAW-A2W-RTWIRELESS</b>	Wireless LCD room thermostat
<b>PAW-A2W-AFVLY-1</b>	1 antifreeze valve. It is required to order 2 valves per system

Bi-bloc accessories	
<b>PAW-TD20C1E5-1</b>	Tank 200 L - Stainless steel
<b>PAW-TD30C1E5-1</b>	Tank 300 L - Stainless steel
<b>PAW-TA20C1E5STD</b>	Tank 200 L - Enamelled
<b>PAW-TA30C1E5STD</b>	Tank 300 L - Enamelled
<b>PAW-3WYVLY-HW</b>	3 way valve for DHW tanks
<b>CZ-NV2</b>	3 way valve kit to fit inside the hydrokit. K and L Series
<b>PAW-BTANK50L-2</b>	Buffer tank 50 L

## NEW Aquarea High Performance Hydraulic M Series Single phase · R290

**Natural refrigerant R290 with GWP 0,02.**

**Energy efficiency:** A+++ in heating at 35 °C.

**Flexibility:** Hydraulic connection between indoor and outdoor / Built-in magnetic water filter.

**Comfort:** Operation without backup heating at -25 °C / 75 °C water outlet temperature maximum at -15 °C outside temperature / 55 °C hot water even at -25 °C outside temperature.



\* For All in One.

Combination table				Outdoor unit		
Indoor unit				Heating capacity		
	DHW tank	Backup heater capacity	Electrical anode	Single phase		
				12,0 kW	16,0 kW	
				WH-WDG12ME5	WH-WDG16ME5	
Hydraulic All in One	1ph	120 L	3 kW	—	✓	✓
		120 L	3 kW	✓	✓	✓
		185 L	3 kW	—	✓	✓
		185 L	3 kW	✓	✓	✓
		185 L	6 kW	—	✓	✓
		260 L	3 kW	—	✓	✓
	3ph	260 L	3 kW	✓	✓	✓
		260 L	6 kW	—	✓	✓
		185 L	9 kW	—	✓	✓
		185 L	9 kW	✓	✓	✓
		260 L	9 kW	—	✓	✓
		260 L	9 kW	✓	✓	✓
Hydraulic Bi-bloc	1ph	—	3 kW	—	✓	✓
		—	6 kW	—	✓	✓
	3ph	—	9 kW	—	✓	✓
Control module	1ph	—	—	—	✓	✓
	3ph	—	—	—	✓	✓
Remote controller with Wi-Fi adapter	—	—	—	—	✓	✓

Outdoor unit			WH-WDG12ME5*	WH-WDG16ME5*
Heating capacity / COP (A +7 °C, W 35 °C)	kW / COP		12,10/4,78	16,00/4,31
Heating capacity / COP (A +7 °C, W 55 °C)	kW / COP		12,10/3,03	14,70/2,72
Heating capacity / COP (A +2 °C, W 35 °C)	kW / COP		11,50/3,44	13,20/3,28
Heating capacity / COP (A +2 °C, W 55 °C)	kW / COP		9,20/2,25	10,00/2,21
Heating capacity / COP (A -7 °C, W 35 °C)	kW / COP		10,10/2,78	11,60/2,57
Heating capacity / COP (A -7 °C, W 55 °C)	kW / COP		8,40/1,99	9,10/1,85
Cooling capacity / EER (A 35 °C, W 7 °C)	kW / EER		9,00/3,61	9,00/3,61
Cooling capacity / EER (A 35 °C, W 18 °C)	kW / EER		9,00/3,92	9,00/3,92
Heating average climate (W 35 °C / W 55 °C)	Seasonal energy efficiency	SCOP (η <sub>s</sub> , %)	4,58/3,57(180/140)	4,46/3,57(176/140)
	Energy class <sup>1)</sup>		A+++ to D	A+++ / A++
Heating warm climate (W 35 °C / W 55 °C)	Seasonal energy efficiency	SCOP (η <sub>s</sub> , %)	6,47/4,34(256/171)	6,20/4,30(245/169)
	Energy class <sup>1)</sup>		A+++ to D	A+++ / A+++
Heating cold climate (W 35 °C / W 55 °C)	Seasonal energy efficiency	SCOP (η <sub>s</sub> , %)	4,31/3,26(169/127)	4,28/3,20(168/125)
	Energy class <sup>1)</sup>		A+++ to D	A++ / A++
Sound power <sup>2)</sup>	Heat	dB(A)	55	59
Dimension / Net weight	H x W x D	mm / kg	1520 x 1200 x 370 / 160	1520 x 1200 x 370 / 160
Pipe length range standard / maximum		m	5/30	5/30
Elevation difference (in / out)		m	30	30
A class pump	Number of speeds		Variable speed	Variable speed
	Input power (Min/Max)		W	30/175
Heating water flow (ΔT=5 K, 35 °C)		L/min	34,4	45,9
Refrigerant (R290) / CO <sub>2</sub> Eq. <sup>3)</sup>		kg / T	1,60/0,00003	1,60/0,00003
Operating range - outdoor ambient	Heat	°C	-25 ~ +35	-25 ~ +35
	Cool	°C	+10 ~ +43	+10 ~ +43
Water outlet	Heat / Cool	°C	25 ~ 75 / 5 ~ 20	25 ~ 75 / 5 ~ 20
Recommended fuse, supply <sup>4)</sup>		A	32	32
Recommended minimum cable size, supply <sup>4)</sup>		mm <sup>2</sup>	3x4,0	3x4,0

1) Scale from A+++ to D. 2) Sound power level in accordance to EN 12102 under conditions of the EN14825 (part load). 3) WH-WDG models are hermetically sealed. 4) Check local regulations. \* EER and COP calculation is based in accordance to EN 14511. \* Available in Autumn 2025.



DHW A+: For All in One. INTERNET CONTROL: Wi-Fi adapter included.



## All in One:

**Energy efficiency:** A+ in DHW / DHW up to 65 °C without heater / Stainless steel DHW tank with U-Vacua™ insulation panel / DHW COP up to 3,60.  
**Flexibility:** Backup heater included / Built-in 10 L expansion vessel / 30 m maximum height difference between indoor and outdoor / Installation in harsh water conditions (for models with Electrical Anode).  
**Control:** All control functions / 2 CN-CNT ports / Optional PCB for advanced functions.  
**Connectivity:** Wi-Fi adapter included / Optional integration into BMS.

Indoor unit		WH-ADC	0916M3E51*	0916M3E52	0916M6E52	0316M9E82	0916M3E53	0916M6E53	0316M9E83
Indoor unit with Electrical Anode		WH-ADC	0916M3E5AN1*	0916M3E5AN2	—	0316M9E8AN2	0916M3E5AN3	—	0316M9E8AN3
Sound pressure	Heat / Cool	dB(A)	22/22	22/22	22/22	22/22	22/22	22/22	22/22
Dimension / Net weight	HxWxD	mm / kg	1293x599 x602/74	1642x599 x602/89	1642x599 x602/89	1642x599 x602/89	2036x599 x602/105	2036x599 x602/105	2036x599 x602/105
Water pipe connector	Room / Shower	Inch	1¼/¾	1¼/¾	1¼/¾	1¼/¾	1¼/¾	1¼/¾	1¼/¾
Water volume		L	120	185	185	185	260	260	260
Maximum DHW temperature		°C	65	65	65	65	65	65	65
Material inside tank			Stainless steel	Stainless steel	Stainless steel	Stainless steel	Stainless steel	Stainless steel	Stainless steel
Water pipe connector (indoor / outdoor units)		Inch	1¼/1¼	1¼/1¼	1¼/1¼	1¼/1¼	1¼/1¼	1¼/1¼	1¼/1¼
Electric backup heater		kW	3,00	3,00	6,00	9,00	3,00	6,00	9,00
Recommended fuse, supply <sup>1)</sup>		A	16	16	30	20	15/16	30	20
Recommended minimum cable size, supply <sup>1)</sup>		mm <sup>2</sup>	3x1,5	3x1,5	3x4,0	5x1,5	3x1,5	3x4,0	5x1,5
Connecting cable to the outdoor unit size		mm <sup>2</sup>	2x0,75	2x0,75	2x0,75	2x0,75	2x0,75	2x0,75	2x0,75

### Domestic Hot Water energy efficiency

Indoor unit	WH-	ADC0916M3E51		ADC0916M3E51		ADC0916M3E52		ADC0916M3E52		ADC0916M3E53		ADC0916M3E53	
		ADC0916M3E5AN1	ADC0916M3E5AN1	ADC0916M3E5AN2	ADC0916M3E5AN2	ADC0916M3E5AN3	ADC0916M3E5AN3	ADC0916M6E52	ADC0916M6E52	ADC0916M6E53	ADC0916M6E53	ADC0916M6E53	ADC0916M6E53
Outdoor unit		WH-WDG12ME5	WH-WDG16ME5	WH-WDG12ME5	WH-WDG16ME5	WH-WDG12ME5	WH-WDG16ME5	WH-WDG12ME5	WH-WDG16ME5	WH-WDG12ME5	WH-WDG16ME5	WH-WDG12ME5	WH-WDG16ME5
Tapping profile according EN16147		L	L	L	L	L	L	XL	XL	XL	XL	XL	XL
DHW tank ERP efficiency average / warm / cold <sup>2)</sup>	A+ to F	A/A/B	A/A/B	A+/A/A	A+/A/A	A+/A+/A	A+/A+/A	A+/A+/A	A+/A+/A	A+/A+/A	A+/A+/A	A+/A+/A	A+/A+/A
DHW tank ERP average climate η / COPdHW	ηwh%/COPdHW	84/2,1	96/2,1	100/2,50	96/2,40	123/3,08	98/2,45						
DHW tank ERP warm climate η / COPdHW	ηwh%/COPdHW	92/2,3	101/2,3	116/2,90	115/2,88	134/3,35	123/3,08						
DHW tank ERP cold climate η / COPdHW	ηwh%/COPdHW	64/1,6	70/1,6	80/2,00	76/1,90	94/2,35	80/2,00						

1) Check local regulations. 2) Scale from A+ to F. Energy class A with 16 kW outdoor unit. \* Available Autumn 2025. Tentative data. \*\* This product is designed to comply with the European drinking water standard (EU) 2020/2184. The lifespan of the product is not guaranteed in the case of the use of groundwater, such as spring water or well water, the use of tap water when salt or other impurities are contained, nor in areas of acidic water quality. Maintenance and warranty costs related to these cases are the customer's responsibility.

## Bi-bloc:

**Flexibility:** Flexible choice of DHW tank size.

**Control:** All control functions / 2 CN-CNT ports / Optional PCB for advanced functions.

**Connectivity:** Wi-Fi adapter included / Optional integration into BMS.

Indoor unit			WH-SDC0916M3E5	WH-SDC0916M6E5	WH-SDC0316M9E8
Sound pressure	Heat / Cool	dB(A)	22/22	22/22	22/22
Dimension / Net weight	HxWxD	mm	892x500x348/28	892x500x348/28	892x500x348/29
Water pipe connector	Room	Inch	1¼	1¼	1¼
Water pipe connector (indoor / outdoor units)		Inch	1¼/1¼	1¼/1¼	1¼/1¼
Electric backup heater		kW	3,00	6,00	9,00
Recommended fuse, supply <sup>1)</sup>		A	15/16	30	20
Recommended minimum cable size, supply <sup>1)</sup>		mm <sup>2</sup>	3x1,5	3x4,0	5x1,5
Connecting cable to the outdoor unit size		mm <sup>2</sup>	2x0,75	2x0,75	2x0,75

1) Check local regulations. \* This product is designed to comply with the European drinking water standard (EU) 2020/2184. The lifespan of the product is not guaranteed in the case of the use of groundwater, such as spring water or well water, the use of tap water when salt or other impurities are contained, nor in areas of acidic water quality. Maintenance and warranty costs related to these cases are the customer's responsibility.

## Control module:

**Flexibility:** Simplified installation / Minimal interior space required / Supports third-party backup heater.

**Control:** All control functions / 2 CN-CNT ports / Optional PCB for advanced functions.

**Connectivity:** Wi-Fi adapter included / Optional integration into BMS.

Indoor unit			WH-CME5	WH-CME8
Dimension / Net weight	HxWxD	mm / kg	454x520x116/7	454x520x116/7
Field supply electrical backup heater		kW	Up to 3 kW	Up to 9 kW
Recommended fuse, supply <sup>1)</sup>		A	16	30
Recommended minimum cable size, supply <sup>1)</sup>		mm <sup>2</sup>	3x1,5	3x4,0
Connecting cable to the outdoor unit size		mm <sup>2</sup>	2x0,75	2x0,75

1) Check local regulations.

Accessories	
<b>CZ-RTW2TAW1C</b>	Remote controller with Wi-Fi adapter (required for stand-alone outdoor units). M Series
<b>CZ-RTW2</b>	Optional remote controller for 2 zone control. M Series
<b>CZ-NS6P</b>	PCB for advanced functions. M Series All in One and Bi-bloc
<b>CZ-NS7P</b>	PCB for advanced functions. M Series control module
<b>PAW-A2W-RTWIRED</b>	Room thermostat
<b>PAW-A2W-RTWIREDLESS</b>	Wireless LCD room thermostat
<b>PAW-A2W-AFVLY-1</b>	1 antifreeze valve. It is required to order 2 valves per system

Accessories	
<b>CZ-NV3</b>	3 way valve kit to fit inside the hydrokit. M Series
<b>PAW-TD20C1E5-1</b>	Tank 200 L - Stainless steel
<b>PAW-TD30C1E5-1</b>	Tank 300 L - Stainless steel
<b>PAW-TA20C1E5STD</b>	Tank 200 L - Enamelled
<b>PAW-TA30C1E5STD</b>	Tank 300 L - Enamelled
<b>PAW-3WYVLY-HW</b>	3 way valve for DHW tanks
<b>PAW-BTANK50L-2</b>	Buffer tank 50 L
<b>PAW-BTANK100L</b>	Buffer tank 100 L
<b>PAW-BTANK200L</b>	Buffer tank 200 L
<b>PAW-BTANK260L</b>	Buffer tank 260 L

## Aquarea High Performance Mono-bloc J Series. Single phase - MDC - R32

**Energy efficiency:** A+++ in heating at 35 °C / "A" water pump with variable speed / Built-in flow meter.

**Flexibility:** Built-in magnetic water filter / Built-in 6 L expansion vessel.

**Comfort:** Operating range and heating curve down to -20 °C / 60 °C water outlet temperature / Cooling mode down to +10 °C.

**Control:** Additional functions with optional PCB (2 zone control, bivalent control, Smart Grid contact and more).

**Connectivity:** Optional Aquarea Smart and Service Cloud and integration into BMS projects.

011-1W0398  
011-1W0399  
011-1W0400

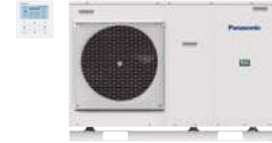

Outdoor unit		Single phase			
		WH-MDC05J3E5	WH-MDC07J3E5	WH-MDC09J3E5	
Heating capacity / COP (A +7 °C, W 35 °C)	kW / COP	5,00/5,08	7,00/4,76	9,00/4,48	
Heating capacity / COP (A +7 °C, W 55 °C)	kW / COP	5,00/3,01	7,00/2,82	8,95/2,78	
Heating capacity / COP (A +2 °C, W 35 °C)	kW / COP	5,00/3,57	7,00/3,40	7,45/3,13	
Heating capacity / COP (A +2 °C, W 55 °C)	kW / COP	5,00/2,27	6,30/2,16	7,00/2,12	
Heating capacity / COP (A -7 °C, W 35 °C)	kW / COP	5,00/2,78	6,80/2,81	7,50/2,63	
Heating capacity / COP (A -7 °C, W 55 °C)	kW / COP	5,00/1,85	6,30/1,86	7,00/1,80	
Cooling capacity / EER (A 35 °C, W 7 °C)	kW / EER	5,00/3,31	7,00/3,06	9,00/2,71	
Cooling capacity / EER (A 35 °C, W 18 °C)	kW / EER	5,00/5,05	7,00/4,73	9,00/4,25	
Heating average climate (W 35 °C / W 55 °C)	Seasonal energy efficiency	SCOP (η <sub>s</sub> %)	5,12/3,63(202/142)	4,90/3,32(193/130)	4,90/3,32(193/130)
	Energy class		A+++ / A++	A+++ / A++	A+++ / A++
Heating warm climate (W 35 °C / W 55 °C)	Seasonal energy efficiency	SCOP (η <sub>s</sub> %)	6,00/4,20(237/165)	5,75/4,07(227/160)	5,75/4,07(227/160)
	Energy class		A+++ / A+++	A+++ / A+++	A+++ / A+++
Heating cold climate (W 35 °C / W 55 °C)	Seasonal energy efficiency	SCOP (η <sub>s</sub> %)	4,08/2,95(160/115)	4,18/2,98(164/116)	4,18/2,98(164/116)
	Energy class		A+++ / A+	A++ / A+	A++ / A+
Sound power <sup>1)</sup>	Heat	dB(A)	59	59	59
Dimension	HxWxD	mm	865x1283x320	865x1283x320	865x1283x320
Net weight		kg	99	104	104
Refrigerant (R32) / CO <sub>2</sub> Eq. <sup>2)</sup>		kg / T	1,3/0,878	1,3/0,878	1,3/0,878
Water pipe connector		Inch	R 1½	R 1½	R 1½
Pump	Number of speeds		Variable speed	Variable speed	Variable speed
	Input power (Min/Max)	W	34/96	36/100	39/108
Heating water flow (ΔT=5 K, 35 °C)		L/min	14,3	20,1	25,8
Electric backup heater		kW	3,00	3,00	3,00
Input power	Heat	kW	0,985	1,47	2,01
	Cool	kW	1,51	2,29	3,32
Running and starting current	Heat	A	4,7	7,0	9,3
	Cool	A	7,0	10,5	14,7
Current 1		A	12	17	17
Current 2		A	13	13	13
Recommended fuse <sup>3)</sup>		A	30/15	30/15	30/16
Recommended minimum cable size, supply 1 / 2 <sup>3)</sup>		mm <sup>2</sup>	3x1,5/3x1,5	3x2,5/3x1,5	3x2,5/3x1,5
Operating range - outdoor ambient	Heat	°C	-20 ~ -35	-20 ~ -35	-20 ~ -35
	Cool	°C	+10 ~ +43	+10 ~ +43	+10 ~ +43
Water outlet	Heat	°C	20 ~ 60	20 ~ 60	20 ~ 60
	Cool	°C	5 ~ 20	5 ~ 20	5 ~ 20

1) Sound power in accordance to 811/2013, 813/2013 and EN 12102-1:2017 at +7 °C. 2) WH-MDC models are hermetically sealed. 3) Check local regulations. \* EER and COP calculation is based in accordance to EN 14511.

Accessories	
PAW-TD20C1E5-1	Tank 200 L - Stainless steel
PAW-TD30C1E5-1	Tank 300 L - Stainless steel
PAW-TA20C1E5STD	Tank 200 L - Enamelled
PAW-TA30C1E5STD	Tank 300 L - Enamelled
PAW-TD20B8E3-2	Combo Tank 185 L + 80 L - Enamelled
PAW-TD23B6E5	Combo Tank 230 L + 60 L - Stainless steel
PAW-3WYVLV-HW	3 way valve for DHW tanks
PAW-BTANK50L-2	Buffer tank 50 L

Accessories	
CZ-TAW1C	Optional Wi-Fi or WLAN adapter for smart control via Panasonic Comfort Cloud and/or remote maintenance via Aquarea Service Cloud
CZ-TAW1-CBL	10 m extension cable for CZ-TAW1C
PAW-A2W-AFVLY-1	1 antifreeze valve. It is required to order 2 valves per system
PAW-A2W-RTWIRED	Room thermostat
PAW-A2W-RTWIRELESS	Wireless LCD room thermostat



INTERNET CONTROL: Optional.

# Validating efficiency and performance of Aquarea Heat Pumps

Aquarea Heat Pumps achieve outstanding efficiency and performance, validated through ErP labels and Keymark certifications. These credentials ensure that Aquarea Heat Pumps deliver reliable and sustainable heating solutions.



Manufacturer or brand  
Product identifier  
Symbol for space heating  
DHW heating symbol with details of tapping profile

Energy efficiency scale for DHW heating  
Efficiency scale for space heating

Optional symbol where operation is possible only in off-peak periods

Temperature map of Europe with three climate zones and the rated heat output of each

Sound power level outdoors and (where relevant) indoors

## Energy labels: guiding consumers to energy savings

Energy labels help consumers make informed purchasing decisions and support Ecodesign requirements that reduce energy demand and combat global warming. Heat pumps are classified into seven efficiency categories, from A+++ (most efficient) to D (least efficient). For hot water cylinders, the range is from A+ to F. Thanks to advanced technologies, Panasonic offers solutions that achieve the highest energy ratings, ensuring high efficiency and performance.



## Keymark certification: a mark of quality and reliability

The Keymark certification is a quality mark that demonstrates compliance with European standards. Issued by independent certification bodies, it ensures products meet rigorous quality and performance criteria. Aquarea Heat Pumps proudly carry the Keymark certification, validating their exceptional efficiency and reliability.



Check all our certified heat pumps on: [www.heatpumpkeymark.com](http://www.heatpumpkeymark.com)



## Aquarea T-CAP Hydraulic M Series outdoor units. Single phase / Three phase · R290

**Natural refrigerant R290 with GWP 0,02.**

**Energy efficiency:** A+++ in heating at 35 °C / Built-in flow meter.

**Flexibility:** Hydraulic connection between indoor and outdoor / Built-in magnetic water filter.

**Comfort:** Constant capacity down to -20 °C / Operating range down to -28 °C / 75 °C water temperature at -15 °C outside / 55 °C hot water even at -25 °C outside temperature / Low noise level.

**Control:** Optimised user interface and improved features [2 zone control, bivalent control].



\* For All in One.

Combination table - Aquarea T-CAP Hydraulic M Series				Outdoor unit						
Indoor unit				Heating capacity						
	DHW tank	Backup heater capacity	Electrical anode	Single phase		Three phase				
				9,0 kW	12,0 kW	9,0 kW	12,0 kW	16,0 kW		
				WH-WXG09ME5	WH-WXG12ME5	WH-WXG09ME8	WH-WXG12ME8	WH-WXG16ME8		
Hydraulic All in One	1ph	120 L	3 kW	—	WH-ADC0916M3E51	✓	✓	—	—	—
		120 L	3 kW	✓	WH-ADC0916M3E5AN1	✓	✓	—	—	—
		185 L	3 kW	—	WH-ADC0916M3E52	✓	✓	—	—	—
		185 L	3 kW	✓	WH-ADC0916M3E5AN2	✓	✓	—	—	—
		185 L	6 kW	—	WH-ADC0916M6E52	✓	✓	—	—	—
	3ph	260 L	3 kW	—	WH-ADC0916M3E53	✓	✓	—	—	—
		260 L	3 kW	✓	WH-ADC0916M3E5AN3	✓	✓	—	—	—
		260 L	6 kW	—	WH-ADC0916M6E53	✓	✓	—	—	—
		120 L	9 kW	—	WH-ADC0916M9E81	—	—	✓	✓	✓
		120 L	9 kW	✓	WH-ADC0916M9E8AN1	—	—	✓	✓	✓
Hydraulic Bi-bloc	1ph	—	3 kW	—	WH-SDC0916M3E5	✓	✓	—	—	—
		—	6 kW	—	WH-SDC0916M6E5	✓	✓	—	—	—
	3ph	—	9 kW	—	WH-SDC0316M9E8	✓	✓	✓	✓	✓
		—	9 kW	✓	WH-SDC0316M9E8AN1	✓	✓	✓	✓	✓
Control module	1ph	—	—	—	WH-CME5	✓	✓	—	—	—
	3ph	—	—	—	WH-CME8	✓	✓	✓	✓	✓
Remote controller with Wi-Fi adapter	—	—	—	—	CZ-RTW2TAW1C	✓	✓	✓	✓	✓

Combination table - Big Aquarea T-CAP Hydraulic M Series				Outdoor unit		
Indoor unit				Heating capacity		
	Control module	3ph	WH-CME8L	Three phase		
				20,0 kW	25,0 kW	30,0 kW
				WH-WXG20ME8	WH-WXG25ME8	WH-WXG30ME8
Remote controller with Wi-Fi adapter	—	—	CZ-RTW2TAW1C	✓	✓	✓

Accessories	
CZ-RTW2TAW1C	Remote controller with Wi-Fi adapter (required for stand-alone outdoor units). M Series
CZ-RTW2	Optional remote controller for 2 zone control. M Series
CZ-NS6P	PCB for advanced functions. M Series All in One and Bi-bloc
CZ-NS7P	PCB for advanced functions. M Series control module
PAW-A2W-RTWIRED	Room thermostat
PAW-A2W-RTWIREDLESS	Wireless LCD room thermostat
PAW-A2W-AFVLV-112	1 antifreeze valve 1 1/2". It is required to order 2 valves per system. For 20, 25 and 30 kW
PAW-A2W-AFVLV-1	1 antifreeze valve. It is required to order 2 valves per system. For 9, 12 and 16 kW

Accessories	
PAW-TD20C1E5-1	Tank 200 L - Stainless steel
PAW-TD30C1E5-1	Tank 300 L - Stainless steel
PAW-TA20C1E5STD	Tank 200 L - Enamelled
PAW-TA30C1E5STD	Tank 300 L - Enamelled
PAW-3WYVLV-HW	3 way valve for DHW tanks
PAW-BTANK50L-2	Buffer tank 50 L
PAW-BTANK100L	Buffer tank 100 L
PAW-BTANK200L	Buffer tank 200 L
PAW-BTANK260L	Buffer tank 260 L



DHW A+: For All in One. INTERNET CONTROL: Wi-Fi adapter included.

## Aquarea T-CAP Hydraulic M Series outdoor units.

Outdoor unit		WH-WXG09ME5	WH-WXG12ME5	WH-WXG09ME8	WH-WXG12ME8	WH-WXG16ME8	
Heating capacity / COP (A +7 °C, W 35 °C)	kW / COP	9,00/5,23	12,00/5,06	9,00/5,23	12,00/5,06	16,00/4,89	
Heating capacity / COP (A +7 °C, W 55 °C)	kW / COP	9,00/3,24	12,00/3,23	9,00/3,24	12,00/3,23	16,00/3,20	
Heating capacity / COP (A +2 °C, W 35 °C)	kW / COP	9,00/3,81	12,00/3,54	9,00/3,81	12,00/3,54	16,00/3,30	
Heating capacity / COP (A +2 °C, W 55 °C)	kW / COP	9,00/2,54	12,00/2,42	9,00/2,54	12,00/2,42	16,00/2,37	
Heating capacity / COP (A -7 °C, W 35 °C)	kW / COP	9,00/3,45	12,00/3,00	9,00/3,45	12,00/3,00	16,00/2,53	
Heating capacity / COP (A -7 °C, W 55 °C)	kW / COP	9,00/2,35	12,00/2,17	9,00/2,35	12,00/2,17	16,00/1,97	
Cooling capacity / EER (A 35 °C, W 7 °C)	kW / EER	9,00/3,61	9,00/3,61	9,00/3,61	9,00/3,61	9,00/3,61	
Cooling capacity / EER (A 35 °C, W 18 °C)	kW / EER	9,00/5,26	12,00/5,26	9,00/5,26	12,00/5,26	16,00/5,26	
Heating average climate (W 35 °C / W 55 °C)	Seasonal energy efficiency	SCOP (η <sub>s</sub> %)	4,96/3,57(195/140)	5,00/3,46(197/135)	5,00/3,50(197/137)	4,73/3,65(186/143)	4,75/3,70(187/115)
	Energy class <sup>1)</sup>	A+++ to D	A+++/A++	A+++/A++	A+++/A++	A+++/A++	A+++/A++
Heating warm climate (W 35 °C / W 55 °C)	Seasonal energy efficiency	SCOP (η <sub>s</sub> %)	6,47/4,34(256/171)	6,47/4,34(256/171)	6,33/4,40(250/173)	6,20/4,40(245/173)	6,08/4,45(240/175)
	Energy class <sup>1)</sup>	A+++ to D	A+++/A+++	A+++/A+++	A+++/A+++	A+++/A+++	A+++/A+++
Heating cold climate (W 35 °C / W 55 °C)	Seasonal energy efficiency	SCOP (η <sub>s</sub> %)	4,31/3,26(169/127)	4,31/3,26(169/127)	4,45/3,20(175/125)	4,38/3,25(172/127)	4,33/3,40(170/133)
	Energy class <sup>1)</sup>	A+++ to D	A++/A++	A++/A++	A+++/A++	A++/A++	A++/A++
Sound power <sup>2)</sup>	Heat	dB(A)	52	53	52	53	57
Dimension	H x W x D	mm	1520 x 1200 x 430	1520 x 1200 x 430	1520 x 1200 x 430	1520 x 1200 x 430	1520 x 1200 x 430
Net weight		kg	161	161	161	161	165
A class pump	Number of speeds		Variable speed	Variable speed	Variable speed	Variable speed	Variable speed
	Input power (Min/Max)	W	30/175	30/175	30/175	30/175	30/175
Heating water flow (ΔT=5 K, 35 °C)		L/min	25,8	34,4	25,8	34,4	45,9
Refrigerant (R290) / CO <sub>2</sub> Eq. <sup>3)</sup>		kg / T	1,78/0,00004	1,78/0,00004	1,78/0,00004	1,78/0,00004	1,78/0,00004
Operating range - outdoor ambient	Heat	°C	-28 ~ +35	-28 ~ +35	-28 ~ +35	-28 ~ +35	-28 ~ +35
	Cool	°C	+10 ~ +43	+10 ~ +43	+10 ~ +43	+10 ~ +43	+10 ~ +43
	DHW	°C	-28 ~ +43	-28 ~ +43	-28 ~ +43	-28 ~ +43	-28 ~ +43
Water outlet	Heat / Cool	°C	25 ~ 75 <sup>4)</sup> / 5 ~ 20	25 ~ 75 <sup>4)</sup> / 5 ~ 20	25 ~ 75 <sup>4)</sup> / 5 ~ 20	25 ~ 75 <sup>4)</sup> / 5 ~ 20	25 ~ 75 <sup>4)</sup> / 5 ~ 20
Recommended fuse, supply <sup>5)</sup>		A	30	30	20	20	25
Recommended minimum cable size, supply <sup>5)</sup>		mm <sup>2</sup>	3x4,0	3x4,0	5x1,5	5x1,5	5x2,5

1) Scale from A+++ to D. 2) Sound power level in accordance to EN 12102 under conditions of the EN14825 (part load). 3) WH-WXG models are hermetically sealed. 4) Above -15 °C outdoor temperature. Between outdoor ambient -15 °C and -25 °C, the water outlet temperature gradually decreases from 75 °C to 55 °C. Below -25 °C outdoor temperature maximum water outlet temperature is 55 °C. 5) Check local regulations. \* EER and COP calculation is based in accordance to EN 14511.

## Big Aquarea T-CAP Hydraulic M Series outdoor units.

Outdoor unit		WH-WXG20ME8	WH-WXG25ME8	WH-WXG30ME8	
Heating capacity / COP (A +7 °C, W 35 °C)	kW / COP	20,00/4,80	25,00/4,50	30,00/4,40	
Heating capacity / COP (A +7 °C, W 55 °C)	kW / COP	20,00/3,18	25,00/3,00	30,00/3,00	
Heating capacity / COP (A +2 °C, W 35 °C)	kW / COP	20,00/3,39	25,00/2,80	30,00/2,50	
Heating capacity / COP (A +2 °C, W 55 °C)	kW / COP	20,00/2,08	25,00/1,97	30,00/1,95	
Heating capacity / COP (A -7 °C, W 35 °C)	kW / COP	20,00/2,48	25,00/2,36	30,00/2,33	
Heating capacity / COP (A -7 °C, W 55 °C)	kW / COP	20,00/1,90	25,00/1,80	30,00/1,49	
Cooling capacity / EER (A 35 °C, W 7 °C) at Comfort mode	kW / EER	20,00/3,02	25,00/2,86	26,00/2,68	
Cooling capacity / EER (A 35 °C, W 7 °C) at Efficiency mode (default)	kW / EER	15,00/3,61	15,00/3,61	15,00/3,61	
Cooling capacity / EER (A 35 °C, W 18 °C) at Comfort mode	kW / EER	20,00/4,79	25,00/4,47	30,00/4,10	
Heating average climate (W 35 °C / W 55 °C)	Seasonal energy efficiency	SCOP (η <sub>s</sub> %)	4,36/3,59 (171/141)	4,25/3,57 (167/140)	3,95/3,46 (155/135)
	Energy class <sup>1)</sup>	A+++ to D	A++/A++	A++/A++	A++/A++
Heating warm climate (W 35 °C / W 55 °C)	Seasonal energy efficiency	SCOP (η <sub>s</sub> %)	5,37/4,07 (212/160)	5,22/4,14 (206/163)	4,93/4,01 (194/158)
	Energy class <sup>1)</sup>	A+++ to D	A+++/A+++	A+++/A+++	A+++/A+++
Heating cold climate (W 35 °C / W 55 °C)	Seasonal energy efficiency	SCOP (η <sub>s</sub> %)	3,07/2,57 (120/100)	3,16/2,71 (123/105)	3,20/2,71 (125/105)
	Energy class <sup>1)</sup>	A+++ to D	A/A+	A+/A+	A+/A+
Sound power <sup>2)</sup>	Heat	dB(A)	56	59	61
Dimension	H x W x D	mm	1645 x 1500 x 460	1645 x 1500 x 460	1645 x 1500 x 460
Net weight		kg	240	240	240
A class pump	Number of speeds		Variable speed	Variable speed	Variable speed
	Input power (Min/Max)	W	230	230	230
Heating water flow (ΔT=5 K, 35 °C)		L/min	57,3	71,6	86,0
Refrigerant (R290) / CO <sub>2</sub> Eq. <sup>3)</sup>		kg / T	3,0/0,00006	3,0/0,00006	3,0/0,00006
Operating range - outdoor ambient	Heat	°C	-25 ~ +35	-25 ~ +35	-25 ~ +35
	Cool	°C	+10 ~ +43	+10 ~ +43	+10 ~ +43
Water outlet	Heat / Cool	°C	20 ~ 75 <sup>4)</sup> / 5 ~ 20	20 ~ 75 <sup>4)</sup> / 5 ~ 20	20 ~ 75 <sup>4)</sup> / 5 ~ 20
Recommended fuse, supply <sup>5)</sup>		A	50	50	50
Recommended minimum cable size, supply <sup>5)</sup>		mm <sup>2</sup>	5x10 - 5x16	5x10 - 5x16	5x10 - 5x16

1) Scale from A+++ to D. 2) Sound power level in accordance to EN 12102 under conditions of the EN14825 (part load). 3) WH-WXG models are hermetically sealed. 4) Above 15 °C ambient temperature. 5) Check local regulations. \* EER and COP calculation is based in accordance to EN 14511.

## Aquarea T-CAP Hydraulic M Series indoor units. Single phase / Three phase · R290

Natural refrigerant R290 with GWP 0,02.

**Control:** All control functions / 2 CN-CNT ports / Optional PCB for advanced functions.

**Connectivity:** Wi-Fi adapter included / Optional integration into BMS.



\* For All in One.

### Control module:

**Flexibility:** Simplified installation / Minimal interior space required / Supports third-party backup heater.

Indoor unit		WH-CME5	WH-CME8	WH-CME8L
Dimension / Net weight	HxWxD	mm / kg	454x520 x 116/7	454x520 x 116/7
Field supply electrical backup heater		kW	Up to 3 kW	Up to 9 kW
Recommended fuse, supply <sup>1)</sup>		A	16	30
Recommended minimum cable size, supply <sup>1)</sup>		mm <sup>2</sup>	3x1,5	3x4,0
Connecting cable to the outdoor unit size		mm <sup>2</sup>	2x0,75	2x0,75

1) Check local regulations.

### Bi-bloc:

**Flexibility:** Flexible choice of DHW tank size.

Indoor unit		WH-SDC0916M3E5	WH-SDC0916M6E5	WH-SDC0316M9E8
Sound pressure	Heat / Cool	dB(A)	22/22	22/22
Dimension / Net weight	HxWxD	mm	892x500x348/28	892x500x348/28
Water pipe connector	Room	Inch	1¼	1¼
Water pipe connector (indoor / outdoor units)		Inch	1¼/1¼	1¼/1¼
Pipe length range standard / maximum		m	5/30	5/30
Elevation difference (in / out)		m	30	30

Electrical information for Bi-bloc and All in One indoor units		Single phase (3 kW heater)	Single phase (6 kW heater)	Three phase (9 kW heater)
Electric backup heater	kW	3	6	9
Recommended fuse, supply <sup>1)</sup>	A	16	30	20
Recommended minimum cable size, supply <sup>1)</sup>	mm <sup>2</sup>	3x1,5	3x4,0	5x1,5
Connecting cable to the outdoor unit size	mm <sup>2</sup>	2x0,75	2x0,75	2x0,75

1) Check local regulations. \* This product is designed to comply with the European drinking water standard (EU) 2020/2184. The lifespan of the product is not guaranteed in the case of the use of groundwater, such as spring water or well water, the use of tap water when salt or other impurities are contained, nor in areas of acidic water quality. Maintenance and warranty costs related to these cases are the customer's responsibility.

Accessories	
<b>CZ-RTW2TAW1C</b>	Remote controller with Wi-Fi adapter (required for stand-alone outdoor units). M Series
<b>CZ-RTW2</b>	Optional remote controller for 2 zone control. M Series
<b>CZ-NS6P</b>	PCB for advanced functions. M Series All in One and Bi-bloc
<b>CZ-NS7P</b>	PCB for advanced functions. M Series control module
<b>PAW-A2W-RTWIRED</b>	Room thermostat
<b>PAW-A2W-RTWIREDLESS</b>	Wireless LCD room thermostat
<b>CZ-NV3</b>	3 way valve kit to fit inside the hydrokit. M Series

Accessories	
<b>PAW-TD20C1E5-1</b>	Tank 200 L - Stainless steel
<b>PAW-TD30C1E5-1</b>	Tank 300 L - Stainless steel
<b>PAW-TA20C1E5STD</b>	Tank 200 L - Enamelled
<b>PAW-TA30C1E5STD</b>	Tank 300 L - Enamelled
<b>PAW-3WYVLV-HW</b>	3 way valve for DHW tanks
<b>PAW-BTANK50L-2</b>	Buffer tank 50 L
<b>PAW-BTANK100L</b>	Buffer tank 100 L
<b>PAW-BTANKG200L</b>	Buffer tank 200 L
<b>PAW-BTANKG260L</b>	Buffer tank 260 L



DHW A+: For All in One. INTERNET CONTROL: Wi-Fi adapter included.

## All in One:

**Energy efficiency:** A+ in DHW / DHW up to 65 °C without heater / Stainless steel DHW tank with U-Vacua™ insulation panel / DHW COP up to 3,60.  
**Flexibility:** Backup heater included / Built-in 10 L expansion vessel / 30 m maximum height difference between indoor and outdoor / Installation in harsh water conditions (for models with Electrical Anode).

All in One with 120 L DHW tank*			Single phase	Three phase
<b>Indoor unit</b>			<b>WH-ADC0916M3E51</b>	<b>WH-ADC0916M9E81</b>
<b>Indoor unit with Electrical Anode</b>			<b>WH-ADC0916M3E5AN1</b>	<b>WH-ADC0916M9E8AN1</b>
Dimension / Net weight	H x W x D	mm / kg	1293 x 599 x 602 / 74	
Water volume		L	120	
Electric backup heater		kW	3	

## Domestic Hot Water energy efficiency

Indoor unit		WH-ADC0916M3E51	WH-ADC0916M3E5AN1	WH-ADC0916M9E81	WH-ADC0916M9E8AN1
<b>Outdoor unit</b>		<b>WH-WXG09ME5</b>	<b>WH-WXG12ME5</b>	<b>WH-WXG09ME8</b>	<b>WH-WXG12ME8</b>
Tapping profile according EN16147		L	L	L	L
DHW tank ERP efficiency average / warm / cold <sup>1)</sup>	A+ to F	A+ / A / A	A+ / A / A	A+ / A / A	A+ / A / A
DHW tank ERP average climate $\eta$ / COPdHW	$\eta_{wh}$ % / COPdHW	96 / 2,41	96 / 2,41	96 / 2,41	96 / 2,41
DHW tank ERP warm climate $\eta$ / COPdHW	$\eta_{wh}$ % / COPdHW	101 / 2,7	101 / 2,7	101 / 2,7	101 / 2,7
DHW tank ERP cold climate $\eta$ / COPdHW	$\eta_{wh}$ % / COPdHW	70 / 1,75	70 / 1,75	70 / 1,75	70 / 1,75

All in One with 185 L DHW tank			Single phase	Three phase
<b>Indoor unit</b>			<b>WH-ADC0916M3E52</b>	<b>WH-ADC0316M9E82</b>
<b>Indoor unit with Electrical Anode</b>			<b>WH-ADC0916M3E5AN2</b>	<b>WH-ADC0316M9E8AN2</b>
Dimension / Net weight	H x W x D	mm / kg	1642 x 599 x 602 / 89	1642 x 599 x 602 / 89
Water volume		L	185	185
Electric backup heater		kW	3	9

## Domestic Hot Water energy efficiency

Indoor unit		WH-ADC0916M3E52	WH-ADC0916M3E5AN2	WH-ADC0316M9E82	WH-ADC0316M9E8AN2
<b>Outdoor unit</b>		<b>WH-WXG09ME5</b>	<b>WH-WXG12ME5</b>	<b>WH-WXG09ME8</b>	<b>WH-WXG12ME8</b>
Tapping profile according EN16147		L	L	L	L
DHW tank ERP efficiency average / warm / cold <sup>1)</sup>	A+ to F	A+ / A+ / A	A+ / A+ / A	A+ / A+ / A	A+ / A+ / A
DHW tank ERP average climate $\eta$ / COPdHW	$\eta_{wh}$ % / COPdHW	123 / 3,00	123 / 3,00	123 / 3,00	117 / 2,85
DHW tank ERP warm climate $\eta$ / COPdHW	$\eta_{wh}$ % / COPdHW	132 / 3,30	132 / 3,30	132 / 3,30	128 / 3,20
DHW tank ERP cold climate $\eta$ / COPdHW	$\eta_{wh}$ % / COPdHW	88 / 2,20	88 / 2,20	88 / 2,20	84 / 2,10

All in One with 260 L DHW tank			Single phase	Three phase
<b>Indoor unit</b>			<b>WH-ADC0916M3E53</b>	<b>WH-ADC0316M9E83</b>
<b>Indoor unit with Electrical Anode</b>			<b>WH-ADC0916M3E5AN3</b>	<b>WH-ADC0316M9E8AN3</b>
Dimension / Net weight	H x W x D	mm / kg	2036 x 599 x 602 / 105	2036 x 599 x 602 / 105
Water volume		L	260	260
Electric backup heater		kW	3	9

## Domestic Hot Water energy efficiency

Indoor unit		WH-ADC0916M3E53	WH-ADC0916M3E5AN3	WH-ADC0316M9E83	WH-ADC0316M9E8AN3
<b>Outdoor unit</b>		<b>WH-WXG09ME5</b>	<b>WH-WXG12ME5</b>	<b>WH-WXG09ME8</b>	<b>WH-WXG12ME8</b>
Tapping profile according EN16147		XL	XL	XL	XL
DHW tank ERP efficiency average / warm / cold <sup>1)</sup>	A+ to F	A+ / A+ / A	A+ / A+ / A	A+ / A+ / A	A / A+ / A
DHW tank ERP average climate $\eta$ / COPdHW	$\eta_{wh}$ % / COPdHW	123 / 3,00	123 / 3,00	125 / 3,10	115 / 2,85
DHW tank ERP warm climate $\eta$ / COPdHW	$\eta_{wh}$ % / COPdHW	132 / 3,30	132 / 3,30	136 / 3,35	129 / 3,20
DHW tank ERP cold climate $\eta$ / COPdHW	$\eta_{wh}$ % / COPdHW	88 / 2,20	88 / 2,20	95 / 2,35	85 / 2,10

## All in One Indoor units technical data

Sound pressure	Heat / Cool	dB(A)	22 / 22
Water pipe connector	Room	Inch	1¼
	Shower	Inch	3/4
Maximum DHW temperature		°C	65
Material inside tank			Stainless steel
Water pipe connector (indoor / outdoor units)		Inch	1¼ / 1¼
Pipe length range standard / maximum		m	5 / 30
Elevation difference (in / out)		m	30

1) Scale from A+ to F. \* Available in Autumn 2025. Tentative data. \*\* This product is designed to comply with the European drinking water standard [EU] 2020/2184. The lifespan of the product is not guaranteed in the case of the use of groundwater, such as spring water or well water, the use of tap water when salt or other impurities are contained, nor in areas of acidic water quality. Maintenance and warranty costs related to these cases are the customer's responsibility.

## Aquarea T-CAP Mono-bloc J Series. Single phase / Three phase - MXC · R32

**Energy efficiency:** A+++ in heating at 35 °C / "A" water pump with variable speed / Built-in flow meter.

**Flexibility:** Built-in magnetic water filter.

**Comfort:** Constant capacity and operating range down to -20 °C / 65 °C water outlet temperature.

**Control:** Additional functions with optional PCB (2 zone control, bivalent control, Smart Grid contact and more).

**Connectivity:** Optional Aquarea Smart and Service Cloud and integration into BMS projects.

 011-1W0463, 011-1W0464, 011-1W0562, 011-1W0563, 011-1W0564, 011-1W0565. For 9 and 12 kW single and three phase.

 ErP 55 °C  
Scale from A+++ to D

 ErP 35 °C  
Scale from A+++ to D

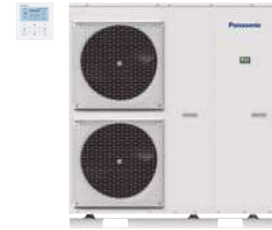

Outdoor unit		Single phase			Three phase		
		WH-MXC09J3E5	WH-MXC12J6E5	WH-MXC09J3E8	WH-MXC12J9E8	WH-MXC16J9E8	
Heating capacity / COP (A +7 °C, W 35 °C)	kW / COP	9,00/5,08	12,00/4,80	9,00/5,08	12,00/4,80	16,00/4,52	
Heating capacity / COP (A +7 °C, W 55 °C)	kW / COP	9,00/3,08	12,00/3,05	9,00/3,08	12,00/3,05	16,00/2,86	
Heating capacity / COP (A +2 °C, W 35 °C)	kW / COP	9,00/3,81	12,00/3,53	9,00/3,81	12,00/3,53	16,00/3,10	
Heating capacity / COP (A +2 °C, W 55 °C)	kW / COP	9,00/2,54	12,00/2,42	9,00/2,54	12,00/2,42	16,00/2,07	
Heating capacity / COP (A -7 °C, W 35 °C)	kW / COP	9,00/3,08	12,00/2,82	9,00/3,08	12,00/2,82	16,00/2,39	
Heating capacity / COP (A -7 °C, W 55 °C)	kW / COP	9,00/2,12	12,00/2,00	9,00/2,12	12,00/2,00	16,00/1,71	
Cooling capacity / EER (A 35 °C, W 7 °C)	kW / EER	9,00/3,18	12,00/2,90	9,00/3,09	12,00/2,84	14,50/2,84	
Cooling capacity / EER (A 35 °C, W 18 °C)	kW / EER	9,00/4,62	12,00/3,95	9,00/4,46	12,00/3,79	16,00/3,75	
Heating average climate (W 35 °C / W 55 °C)	Seasonal energy efficiency	SCOP (η <sub>s</sub> %)	4,96/3,57(195/140)	4,96/3,57(195/140)	4,96/3,57(195/140)	4,96/3,57(195/140)	4,46/3,31(176/129)
	Energy class <sup>1)</sup>		A+++ / A++	A+++ / A++	A+++ / A++	A+++ / A++	A+++ / A++
Heating warm climate (W 35 °C / W 55 °C)	Seasonal energy efficiency	SCOP (η <sub>s</sub> %)	6,47/4,34(256/171)	6,47/4,34(256/171)	6,47/4,34(256/171)	6,47/4,34(256/171)	5,88/4,09(232/160)
	Energy class <sup>1)</sup>		A+++ / A+++	A+++ / A+++	A+++ / A+++	A+++ / A+++	A+++ / A+++
Heating cold climate (W 35 °C / W 55 °C)	Seasonal energy efficiency	SCOP (η <sub>s</sub> %)	4,31/3,26(169/127)	4,31/3,26(169/127)	4,31/3,26(169/127)	4,31/3,26(169/127)	3,83/3,20(150/125)
	Energy class <sup>1)</sup>		A+++ to D	A++ / A++	A++ / A++	A++ / A++	A++ / A++
Sound power <sup>2)</sup>	Heat	dB(A)	61	61	61	61	63
Dimension	H x W x D	mm	1410 x 1283 x 320	1410 x 1283 x 320	1410 x 1283 x 320	1410 x 1283 x 320	1410 x 1283 x 320
Net weight		kg	140	140	140	140	150
Refrigerant (R32) / CO <sub>2</sub> Eq. <sup>3)</sup>		kg / T	1,60/1,080	1,60/1,080	1,60/1,080	1,60/1,080	1,80/1,215
Water pipe connector		Inch	R 1 1/4	R 1 1/4	R 1 1/4	R 1 1/4	R 1 1/4
Pump	Number of speeds		Variable speed	Variable speed	Variable speed	Variable speed	Variable speed
	Input power (Min/Max)	W	32/145	34/145	145	145	145
Heating water flow (ΔT=5 K, 35 °C)		L/min	25,8	34,4	25,8	34,4	45,9
Electric backup heater		kW	3,00	6,00	3,00	9,00	9,00
Input power	Heat	kW	1,77	2,50	1,77	2,50	3,54
	Cool	kW	2,83	4,14	2,91	4,23	5,11
Running and starting current	Heat	A	8,3	11,6	2,6	3,7	5,3
	Cool	A	13,1	19,1	4,3	6,3	7,6
Current 1		A	29,0	29,0	14,7	11,8	16,4
Current 2		A	13,0	26,0	13,0	13,0	13,0
Recommended fuse, supply 1 / 2 <sup>4)</sup>		A	30/30	30/30	20/16	20/20	20/20
Recommended minimum cable size, supply 1 / 2 <sup>4)</sup>		mm <sup>2</sup>	3x4,0/3x4,0	3x4,0/3x4,0	5x1,5/3x1,5	5x1,5/5x1,5	5x2,5/5x1,5
Operating range - outdoor ambient	Heat	°C	-20 ~ +35	-20 ~ +35	-20 ~ +35	-20 ~ +35	-20 ~ +35
	Cool	°C	10 ~ +43	10 ~ +43	10 ~ +43	10 ~ +43	10 ~ +43
Water outlet <sup>5)</sup>	Heat	°C	20 ~ 65	20 ~ 65	20 ~ 65	20 ~ 65	20 ~ 65
	Cool	°C	5 ~ 20	5 ~ 20	5 ~ 20	5 ~ 20	5 ~ 20

1) Scale from A+++ to D. 2) Sound power level in accordance to EN 12102 under conditions of the EN14825. 3) WH-MXC models are hermetically sealed. 4) Check local regulations. 5) It is possible to set temperature by 65 °C on remote controller. Normally, outlet water temperature is 60 °C or lower. In case of ΔT setting with remote controller is 15 °C and the outdoor ambient temperature is 5 to 20 °C, outlet water temperature 65 °C is possible. \* EER and COP calculation is based in accordance to EN 14511.

Accessories	
PAW-TD20C1E5-1	Tank 200 L - Stainless steel
PAW-TD30C1E5-1	Tank 300 L - Stainless steel
PAW-TA20C1E5STD	Tank 200 L - Enamelled
PAW-TA30C1E5STD	Tank 300 L - Enamelled
PAW-TD20B8E3-2	Combo Tank 185 L + 80 L - Enamelled
PAW-TD23B6E5	Combo Tank 230 L + 60 L - Stainless steel
PAW-3WYVLV-HW	3 way valve for DHW tanks
PAW-BTANK50L-2	Buffer tank 50 L

Accessories	
CZ-TAW1C	Optional Wi-Fi or WLAN adapter for smart control via Panasonic Comfort Cloud and/or remote maintenance via Aquarea Service Cloud
CZ-TAW1-CBL	10 m extension cable for CZ-TAW1C
PAW-A2W-AFVLV-1	1 antifreeze valve. It is required to order 2 valves per system
PAW-A2W-RTWIRED	Room thermostat
PAW-A2W-RTWIRELESS	Wireless LCD room thermostat



INTERNET CONTROL: Optional.



**Aquarea EcoFlex. Single phase · R32**

**Energy efficiency:** Heat recovery function, to re-use wasted heat of outdoor unit for DHW production.

**Flexibility:** Small foot print outdoor unit, tank unit with a standard size of appliances.

**Comfort:** Non-stop heating operation / nanoe™ X technology to improve protection 24/7 (nanoe X Generator Mark 2).

**Connectivity:** Wi-Fi adapter included via Aquarea Smart Cloud or Panasonic Comfort Cloud App.



**WH-ADF0309J3E5CM**

Air to water	Heating capacity / COP (A +7 °C, W 35 °C)		kW / COP	8,00/4,21	
	Heating capacity / COP (A +7 °C, W 55 °C)		kW / COP	8,00/2,81	
	Heating capacity / COP (A +2 °C, W 35 °C)		kW / COP	6,70/3,25	
	Heating capacity / COP (A +2 °C, W 55 °C)		kW / COP	6,00/2,08	
	Heating capacity / COP (A -7 °C, W 35 °C)		kW / COP	5,60/2,84	
	Heating capacity / COP (A -7 °C, W 55 °C)		kW / COP	5,30/1,91	
	Cooling capacity / EER (A 35 °C, W 7 °C)		kW / EER	—	
	Cooling capacity / EER (A 35 °C, W 18 °C)		kW / EER	—	
	Heating average climate (W 35 °C / W 55 °C)		Seasonal energy efficiency SCOP (η <sub>s</sub> %)	4,00/3,20(157/125)	
			Energy class <sup>1)</sup>	A+++ to D	
	Heating warm climate (W 35 °C / W 55 °C)		Seasonal energy efficiency SCOP (η <sub>s</sub> %)	5,69/3,69(224/145)	
			Energy class <sup>1)</sup>	A+++ to D	
	Heating cold climate (W 35 °C / W 55 °C)		Seasonal energy efficiency SCOP (η <sub>s</sub> %)	3,61/2,80(141/109)	
			Energy class <sup>1)</sup>	A+/A+	
	Sound pressure		Heat / Cool	dB(A)	28/—
	Dimension / Net weight		HxWxD	mm / kg	1880x598x600/108
	Electric backup heater			kW	3,00
	Water volume			L	185
	Maximum DHW temperature			°C	65
	Heating water flow [ΔT=5 K, 35 °C]			L/min	22,90
Tapping profile according EN16147				L	
DHW tank ERP efficiency average / warm / cold <sup>2)</sup>				A+/A+/A	
DHW tank ERP average climate η / COPdhw			η <sub>wh</sub> % / COPdhw	104/2,60	
DHW tank ERP warm climate η / COPdhw			η <sub>wh</sub> % / COPdhw	134/3,35	
DHW tank ERP cold climate η / COPdhw			η <sub>wh</sub> % / COPdhw	92/2,30	
Heat recovery capacity (DHW 55 °C)			kW	7,10+9,00	
Heat recovery input power (DHW 55 °C)			kW	3,15	
Heat recovery COP (DHW 55 °C)				5,11	
Water outlet			°C	20-55	

**S-71WF3E**

Air to air	Cooling capacity		Nominal	kW	7,10
	EER <sup>3)</sup>		Nominal	W/W	3,40
	<b>SEER <sup>4)</sup></b>				<b>5,60 A+</b>
	Pdesign (cooling)				7,10
	Heating capacity		Nominal	kW	7,10
	COP <sup>3)</sup>		Nominal	W/W	3,90
	<b>SCOP <sup>4)</sup></b>				<b>3,90 A</b>
	Pdesign at -10 °C			kW	4,80
	External static pressure <sup>5)</sup>			Pa	30(10-150)
	Air flow			m <sup>3</sup> /min	22,7
	Sound pressure <sup>6)</sup>		Cool / Heat (Hi)	dB(A)	34/34
	Sound power <sup>7)</sup>		Cool / Heat (Hi)	dB(A)	57/57
	Dimension / Net weight		HxWxD	mm / kg	250x1000x730/30
nanoe X Generator				Mark2	

**CU-2WZ71YBE5**

Outdoor unit	Sound pressure		Cool / Heat (air to air)	dB(A)	49/49
	Sound power <sup>7)</sup>		Cool / Heat (air to air)	dB(A)	68/67
	Sound pressure		Heat (air to water)	dB(A)	51
	Sound power <sup>8)</sup>		Heat (air to water)	dB(A)	61
	Dimension / Net weight		HxWxD	mm / kg	999x940x340/82
	Refrigerant (R32) / CO <sub>2</sub> Eq.			kg / T	2,40/1,62
	Piping diameter		Liquid / Gas	Inch (mm)	1/4(6,35)/1/2(12,70)
	Pipe length range / Elevation difference (in / out)			m / m	35/30
	Pre-charged pipe length / Additional gas amount			m / g/m	30/20
	Operating range - outdoor ambient		Heat (air to air)	°C	-15~+24
			Cool (air to air)	°C	-10~+46
Heat (air to water)			°C	-15~+35	
		Heat recovery (floor / DHW)	°C	+10~+35/+10~+46	

1) Scale from A+++ to D. 2) Scale from A+ to F. 3) EER and COP calculation is based in accordance to EN 14511. 4) SEER and SCOP is calculated based on values of EU/626/2011. 5) Medium external static pressure setting from factory. 6) The sound pressure of the units shows the value measured of the position 1,5 m below the unit. The sound pressure is measured in accordance with Eurovent 6/C/006-97 specification. 7) Sound power is measured in accordance with EN 14511 and EN 12102-1:2017 at +7 °C. 8) Sound power in accordance to 811/2013, 813/2013 and EN 12102-1:2017 at +7 °C.



INTERNET CONTROL: Wi-Fi adapter included.

**Aquarea High Performance All in One 185 L K Series. Single phase · R32**

**Energy efficiency:** COP up to 5,33 / A+++ in heating at 35 °C and A+ in DHW / "A" water pump with variable speed / Stainless steel DHW tank with U-Vacua™ insulation panel / DHW COP up to 3,50.

**Flexibility:** 599 x 602 footprint / Easy access to hydraulic parts / Built-in magnetic water filter.

**Comfort:** Operation without backup heating at -25 °C / 60 °C hot water even at -10 °C outside temperature.

**Control:** Optimised user interface and improved features (2 zone control, bivalent control).

**Connectivity:** Optional Aquarea Smart and Service Cloud and integration into BMS projects.



		Single phase [power to indoor]								
Kit 3 kW electric heater		KIT-ADC03K3E5	KIT-ADC05K3E5	KIT-ADC07K6E5	KIT-ADC09K3E5	—	—			
Kit 6 kW electric heater		KIT-ADC03K6E5	KIT-ADC05K6E5	KIT-ADC07K6E5	KIT-ADC09K6E5	KIT-ADC12K6E5	KIT-ADC16K6E5*			
Heating capacity / COP (A +7 °C, W 35 °C)	kW / COP	3,20/5,33	5,00/5,10	7,00/4,86	9,00/4,55	12,10/4,78	16,00/4,31			
Heating capacity / COP (A +7 °C, W 55 °C)	kW / COP	3,20/2,81	5,00/3,03	7,00/2,92	8,90/2,93	12,00/2,96	14,70/2,72			
Heating capacity / COP (A +2 °C, W 35 °C)	kW / COP	3,20/3,64	5,00/3,57	6,85/3,43	7,00/3,40	11,50/3,44	13,00/3,18			
Heating capacity / COP (A +2 °C, W 55 °C)	kW / COP	3,20/2,19	5,00/2,29	6,25/2,23	6,30/2,18	9,20/2,25	10,00/2,24			
Heating capacity / COP (A -7 °C, W 35 °C)	kW / COP	3,30/2,80	5,00/2,79	5,75/2,95	6,25/2,84	10,10/2,74	11,70/2,61			
Heating capacity / COP (A -7 °C, W 55 °C)	kW / COP	3,20/1,79	5,00/1,89	5,35/1,98	5,90/1,93	8,40/1,97	9,10/1,85			
Cooling capacity / EER (A 35 °C, W 7 °C)	kW / EER	3,20/3,52	5,00/3,05	6,70/3,03	8,20/2,72	10,70/2,68	12,20/2,68			
Cooling capacity / EER (A 35 °C, W 18 °C)	kW / EER	3,20/4,71	5,00/4,90	6,70/4,72	9,00/4,18	10,70/3,92	13,00/3,80			
Heating average climate (W 35 °C / W 55 °C)	Seasonal energy efficiency	SCOP (η <sub>s</sub> %)	5,07/3,47(200/136)	5,12/3,63(202/142)	4,90/3,62(193/142)	4,44/3,41(175/133)	4,58/3,33(180/130)	4,46/3,40(176/133)		
	Energy class <sup>1)</sup>	A+++ to D	A+++/A++	A+++/A++	A+++/A++	A+++/A++	A+++/A++	A+++/A++		
Heating warm climate (W 35 °C / W 55 °C)	Seasonal energy efficiency	SCOP (η <sub>s</sub> %)	6,20/4,20(245/165)	6,00/4,20(237/165)	5,75/4,07(227/160)	5,75/4,07(227/160)	6,47/4,34(256/171)	6,20/4,30(245/169)		
	Energy class <sup>1)</sup>	A+++ to D	A+++/A+++	A+++/A+++	A+++/A+++	A+++/A+++	A+++/A+++	A+++/A+++		
Heating cold climate (W 35 °C / W 55 °C)	Seasonal energy efficiency	SCOP (η <sub>s</sub> %)	4,00/2,83(157/110)	4,08/2,95(160/115)	4,18/2,98(164/116)	4,18/2,98(164/116)	4,31/3,26(169/127)	4,28/3,10(168/121)		
	Energy class <sup>1)</sup>	A+++ to D	A++/A+	A++/A+	A++/A+	A++/A+	A++/A+	A++/A+		
<b>Indoor unit 3 kW electric heater</b>		<b>WH-ADC0309K3E5</b>	<b>WH-ADC0309K3E5</b>	<b>WH-ADC0309K3E5</b>	<b>WH-ADC0309K3E5</b>	—	—			
<b>Indoor unit 6 kW electric heater</b>		<b>WH-ADC0309K6E5</b>	<b>WH-ADC0309K6E5</b>	<b>WH-ADC0309K6E5</b>	<b>WH-ADC0309K6E5</b>	<b>WH-ADC0912K6E5</b>	<b>WH-ADC16K6E5</b>			
Sound pressure	Heat / Cool	dB(A)		28/28	28/28	28/28	33/33			
Dimension	HxWxD	mm		1642x599x602	1642x599x602	1642x599x602	1642x599x602			
Net weight 3 kW / 6 kW		kg		100/101	100/101	100/101	—/101			
Water pipe connector		Inch		R 1¼	R 1¼	R 1¼	R 1¼			
A class pump	Number of speeds	Variable speed		Variable speed	Variable speed	Variable speed	Variable speed			
	Input power	W		145	145	145	145			
Heating water flow (ΔT=5 K, 35 °C)		L/min		9,2	14,3	20,1	25,8			
Water volume		L		185	185	185	185			
Maximum DHW temperature		°C		65	65	65	65			
Material inside tank		Stainless steel		Stainless steel	Stainless steel	Stainless steel	Stainless steel			
Tapping profile according EN16147		L		L	L	L	L			
DHW tank ERP efficiency average / warm / cold <sup>2)</sup>	A+ to F	A+ / A++ / A		A+ / A++ / A	A+ / A++ / A	A+ / A++ / A	A+ / A++ / A			
DHW tank ERP average climate η / COP <sub>DHW</sub>	η <sub>wh</sub> % / COP <sub>DHW</sub>	128/3,20		140/3,50	140/3,50	100/2,50	100/2,50			
DHW tank ERP warm climate η / COP <sub>DHW</sub>	η <sub>wh</sub> % / COP <sub>DHW</sub>	154/3,86		160/4,00	160/4,00	116/2,90	116/2,90			
DHW tank ERP cold climate η / COP <sub>DHW</sub>	η <sub>wh</sub> % / COP <sub>DHW</sub>	99/2,48		112/2,80	112/2,80	80/2,00	80/2,00			
<b>Outdoor unit</b>		<b>WH-UDZ03KE5</b>	<b>WH-UDZ05KE5</b>	<b>WH-UDZ07KE5</b>	<b>WH-UDZ09KE5</b>	<b>WH-UDZ12KE5</b>	<b>WH-UDZ16KE5</b>			
Sound power <sup>3)</sup>	Heat	dB(A)		55	55	56	65			
Dimension / Net weight	HxWxD	mm / kg		622x824x298/37	795x875x380/55	795x875x380/55	1340x900x320/88			
Refrigerant (R32) / CO <sub>2</sub> Eq.		kg / T		0,9/0,608	1,3/0,878	1,3/0,878	1,6/1,080			
Piping diameter	Liquid / Gas	Inch (mm)		1/4(6,35)/1/2(12,70)	1/4(6,35)/5/8(15,88)	1/4(6,35)/5/8(15,88)	1/4(6,35)/1/2(12,7)			
Pipe length range / Elevation difference (in / out)	m / m	3-25/20		3-40(3-50) <sup>4)</sup> / 30	3-40(3-50) <sup>4)</sup> / 30	3-40(3-50) <sup>4)</sup> / 30	3-30(3-50) <sup>5)</sup> / 20(30) <sup>5)</sup>			
Pre-charged pipe length / Additional gas amount	m / g/m	10/20		10/25	10/25	10/25	10/30			
Operating range - outdoor ambient	Heat	°C		-20 ~ +35	-25 ~ +35	-25 ~ +35	-25 ~ +35			
	Cool	°C		+10 ~ +43	+10 ~ +43	+10 ~ +43	+10 ~ +43			
Water outlet <sup>6)</sup>	Heat / Cool	°C		20-60/5-20	20-60/5-20	20-60/5-20	20-60/5-20			
<b>Electrical information</b>		<b>Heater</b>	<b>3 kW</b>	<b>6 kW</b>	<b>3 kW</b>	<b>6 kW</b>	<b>3 kW</b>	<b>6 kW</b>	<b>6 kW</b>	<b>6 kW</b>
Electric backup heater	kW	3,00		6,00	3,00	6,00	3,00	6,00	6,00	
Recommended fuse <sup>7)</sup>	A	16/16		16/30	16/16	16/30	25/16	25/30	30/30	
Recommended minimum cable size, supply 1 / 2 <sup>7)</sup>	mm <sup>2</sup>	3x1,5/3x1,5		3x1,5/3x4,0	3x1,5/3x4,0	3x2,5/3x4,0	3x2,5/3x4,0	3x2,5/3x4,0	3x4,0/3x4,0	

1) Scale from A+++ to D. 2) Scale from A+ to F. 3) Sound power level in accordance to EN 12102 under conditions of the EN14825. 4) Operation range down to -25 °C in heating with 3-40 m pipe length range, operation range down to -15 °C in heating with 3-50 m pipe length range. 5) Ambient temperature down to -10 °C. Below -10 °C, permitted piping length and elevation difference is 3-30 m, 20 m. 6) Between outdoor ambient -10 °C and -15 °C, the water outlet temperature gradually decreases from 60 °C to 55 °C. 7) Check local regulations. \* Available in Summer 2025. Tentative data. \*\* EER and COP calculation is based in accordance to EN 14511. \*\*\* This product is designed to comply with the European drinking water standard (EU) 2020/2184. The lifespan of the product is not guaranteed in the case of the use of groundwater, such as spring water or well water, the use of tap water when salt or other impurities are contained, nor in areas of acidic water quality. Maintenance and warranty costs related to these cases are the customer's responsibility.

Accessories	
<b>CZ-RTW1</b>	Optional remote controller for 2 zone control. K and L Series
<b>CZ-TAW1C</b>	Optional Wi-Fi or WLAN adapter for smart control via Panasonic Comfort Cloud and/or remote maintenance via Aquarea Service Cloud

Accessories	
<b>CZ-TAW1-CBL</b>	10 m extension cable for CZ-TAW1C
<b>CZ-NS5P</b>	PCB for advanced functions
<b>PAW-A2W-RTWIRED</b>	Room thermostat
<b>PAW-A2W-RTWIREDLESS</b>	Wireless LCD room thermostat

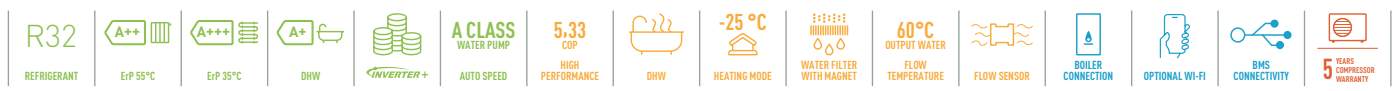

INTERNET CONTROL: Optional.

### Aquarea High Performance All in One 185 L K Series. Single phase with Electrical Anode - R32

**Energy efficiency:** COP up to 5,33 / A+++ in heating at 35 °C and A+ in DHW / "A" water pump with variable speed / Stainless steel DHW tank with U-Vacua™ insulation panel / DHW COP up to 3,50.

**Flexibility:** 599 x 602 footprint / Built-in magnetic water filter / Installation in harsh water conditions.

**Comfort:** Operation without backup heating at -25 °C / 60 °C hot water even at -10 °C outside temperature.

**Control:** Optimised user interface and improved features [2 zone control, bivalent control].

**Connectivity:** Optional Aquarea Smart and Service Cloud and integration into BMS projects.



		Single phase (power to indoor)							
Kit 3 kW electric heater	KIT-	ADC03K3E5AN	ADC05K3E5AN	ADC07K3E5AN	ADC09K3E5AN	—		—	
Kit 6 kW electric heater	KIT-	ADC03K6E5AN	ADC05K6E5AN	ADC07K6E5AN	ADC09K6E5AN	ADC12K6E5AN	ADC16K6E5AN*		ADC16K6E5AN*
Heating capacity / COP (A +7 °C, W 35 °C)	kW / COP	3,20/5,33	5,00/5,10	7,00/4,86	9,00/4,55	12,10/4,78	16,00/4,31		16,00/4,31
Heating capacity / COP (A +7 °C, W 55 °C)	kW / COP	3,20/2,81	5,00/3,03	7,00/2,92	8,90/2,93	12,00/2,96	14,70/2,72		14,70/2,72
Heating capacity / COP (A +2 °C, W 35 °C)	kW / COP	3,20/3,64	5,00/3,57	6,85/3,43	7,00/3,40	11,50/3,44	13,00/3,18		13,00/3,18
Heating capacity / COP (A +2 °C, W 55 °C)	kW / COP	3,20/2,19	5,00/2,29	6,25/2,23	6,30/2,18	9,20/2,25	10,00/2,24		10,00/2,24
Heating capacity / COP (A -7 °C, W 35 °C)	kW / COP	3,30/2,80	5,00/2,79	5,75/2,95	6,25/2,84	10,10/2,74	11,70/2,61		11,70/2,61
Heating capacity / COP (A -7 °C, W 55 °C)	kW / COP	3,20/1,79	5,00/1,89	5,35/1,98	5,90/1,93	8,40/1,97	9,10/1,85		9,10/1,85
Cooling capacity / EER (A 35 °C, W 7 °C)	kW / EER	3,20/3,52	5,00/3,05	6,70/3,03	8,20/2,72	10,70/2,68	12,20/2,68		12,20/2,68
Cooling capacity / EER (A 35 °C, W 18 °C)	kW / EER	3,20/4,71	5,00/4,90	6,70/4,72	9,00/4,18	10,70/3,92	13,00/3,80		13,00/3,80
Heating average climate (W 35 °C / W 55 °C)	Seasonal energy efficiency SCOP (η <sub>s</sub> %)	5,07/3,47(200/136)	5,12/3,63(202/142)	4,90/3,62(193/142)	4,44/3,41(175/133)	4,58/3,33(180/130)	4,46/3,40(176/133)		4,46/3,40(176/133)
	Energy class <sup>1)</sup>	A+++ to D	A+++ / A++	A+++ / A++	A+++ / A++	A+++ / A++	A+++ / A++		A+++ / A++
Heating warm climate (W 35 °C / W 55 °C)	Seasonal energy efficiency SCOP (η <sub>s</sub> %)	6,20/4,20(245/165)	6,00/4,20(237/165)	5,75/4,07(227/160)	5,75/4,07(227/160)	6,47/4,34(256/171)	6,20/4,30(245/169)		6,20/4,30(245/169)
	Energy class <sup>1)</sup>	A+++ to D	A+++ / A+++	A+++ / A+++	A+++ / A+++	A+++ / A+++	A+++ / A+++		A+++ / A+++
Heating cold climate (W 35 °C / W 55 °C)	Seasonal energy efficiency SCOP (η <sub>s</sub> %)	4,00/2,83(157/110)	4,08/2,95(160/115)	4,18/2,98(164/116)	4,18/2,98(164/116)	4,31/3,26(169/127)	4,28/3,10(168/121)		4,28/3,10(168/121)
	Energy class <sup>1)</sup>	A+++ to D	A++ / A+	A++ / A+	A++ / A+	A++ / A+	A++ / A+		A++ / A+
Indoor unit 3 kW electric heater	WH-	ADC0309K3E5AN	ADC0309K3E5AN	ADC0309K3E5AN	ADC0309K3E5AN	—		—	
Indoor unit 6 kW electric heater	WH-	ADC0309K6E5AN	ADC0309K6E5AN	ADC0309K6E5AN	ADC0309K6E5AN	ADC0912K6E5AN	ADC16K6E5AN		ADC16K6E5AN
Sound pressure	Heat / Cool	dB(A)		28/28	28/28	28/28	28/28	33/33	33/33
Dimension	HxWxD	mm		1642x599x602	1642x599x602	1642x599x602	1642x599x602	1642x599x602	1642x599x602
Net weight 3 kW / 6 kW		kg		100/101	100/101	100/101	100/101	—/101	—/101
Water pipe connector		Inch		R 1¼	R 1¼	R 1¼	R 1¼	R 1¼	R 1¼
A class pump	Number of speeds	Variable speed		Variable speed	Variable speed	Variable speed	Variable speed	Variable speed	Variable speed
	Input power	W		145	145	145	145	145	145
Heating water flow (ΔT=5 K, 35 °C)		L/min		9,2	14,3	20,1	25,8	34,4	45,8
Water volume		L		185	185	185	185	185	185
Maximum DHW temperature		°C		65	65	65	65	65	65
Material inside tank		Stainless steel		Stainless steel	Stainless steel	Stainless steel	Stainless steel	Stainless steel	Stainless steel
Tapping profile according EN16147		L		L	L	L	L	L	L
DHW tank ERP efficiency average / warm / cold <sup>2)</sup>	A+ to F	A+ / A++ / A	A+ / A++ / A	A+ / A++ / A	A+ / A++ / A	A+ / A++ / A	A+ / A++ / A	A+ / A++ / A	A+ / A++ / A
DHW tank ERP average climate η / COP <sub>DHW</sub>	η <sub>wh</sub> % / COP <sub>DHW</sub>	128/3,20		140/3,50	140/3,50	140/3,50	100/2,50	100/2,50	100/2,50
DHW tank ERP warm climate η / COP <sub>DHW</sub>	η <sub>wh</sub> % / COP <sub>DHW</sub>	154/3,86		160/4,00	160/4,00	160/4,00	116/2,90	116/2,90	116/2,90
DHW tank ERP cold climate η / COP <sub>DHW</sub>	η <sub>wh</sub> % / COP <sub>DHW</sub>	99/2,48		112/2,80	112/2,80	112/2,80	80/2,00	80/2,00	80/2,00
Outdoor unit		WH-UDZ03KE5	WH-UDZ05KE5	WH-UDZ07KE5	WH-UDZ09KE5	WH-UDZ12KE5	WH-UDZ16KE5		WH-UDZ16KE5
Sound power <sup>3)</sup>	Heat	dB(A)		55	55	56	56	65	65
Dimension / Net weight	HxWxD	mm / kg		622x824x298/37	795x875x380/55	795x875x380/55	795x875x380/55	1340x900x320/88	1340x900x320/88
Refrigerant (R32) / CO <sub>2</sub> Eq.	kg / T	0,9/0,608		1,3/0,878	1,3/0,878	1,3/0,878	1,3/0,878	1,6/1,080	1,6/1,080
Piping diameter	Liquid / Gas	Inch (mm)		1/4(6,35)/1/2(12,70)	1/4(6,35)/5/8(15,88)	1/4(6,35)/5/8(15,88)	1/4(6,35)/5/8(15,88)	1/4(6,35)/1/2(12,7)	1/4(6,35)/5/8(15,88)
Pipe length range / Elevation difference (in / out)	m / m	3 - 25/20		3 - 40(3 - 50) <sup>4)</sup> / 30	3 - 40(3 - 50) <sup>4)</sup> / 30	3 - 40(3 - 50) <sup>4)</sup> / 30	3 - 40(3 - 50) <sup>4)</sup> / 30	3 - 30(3 - 50) <sup>4)</sup> / 20(30) <sup>5)</sup>	3 - 30(3 - 50) <sup>4)</sup> / 20(30) <sup>5)</sup>
Pre-charged pipe length / Additional gas amount	m / g/m	10/20		10/25	10/25	10/25	10/25	10/30	10/30
Operating range - outdoor ambient	Heat	°C		-20 - +35	-25 - +35	-25 - +35	-25 - +35	-25 - +35	-25 - +35
	Cool	°C		+10 - +43	+10 - +43	+10 - +43	+10 - +43	+10 - +43	+10 - +43
Water outlet <sup>6)</sup>	Heat / Cool	°C		20 - 60/5 - 20	20 - 60/5 - 20	20 - 60/5 - 20	20 - 60/5 - 20	20 - 60/5 - 20	20 - 60/5 - 20
Electrical information	Heater	3 kW	6 kW	3 kW	6 kW	3 kW	6 kW	3 kW	6 kW
Electric backup heater	kW	3,00	6,00	3,00	6,00	3,00	6,00	6,00	6,00
Recommended fuse <sup>7)</sup>	A	16/16	16/30	16/16	16/30	25/16	25/30	25/16	25/30
Recommended minimum cable size, supply 1 / 2 <sup>7)</sup>	mm <sup>2</sup>	3x1,5/3x1,5	3x1,5/3x4,0	3x1,5/3x1,5	3x1,5/3x4,0	3x2,5/3x1,5	3x2,5/3x4,0	3x2,5/3x1,5	3x2,5/3x4,0

1) Scale from A+++ to D. 2) Scale from A+ to F. 3) Sound power level in accordance to EN 12102 under conditions of the EN14825. 4) Operation range down to -25 °C in heating with 3 - 40 m pipe length range, operation range down to -10 °C in heating with 3 - 50 m pipe length range. 5) Ambient temperature down to -10 °C. Below -10 °C, permitted piping length and elevation difference is 3 - 30 m, 20 m. 6) Between outdoor ambient -10 °C and -15 °C, the water outlet temperature gradually decreases from 60 °C to 55 °C. 7) Check local regulations. \* Available in Summer 2025. Tentative data. \*\* EER and COP calculation is based in accordance to EN 14511. \*\*\* This product is designed to comply with the European drinking water standard (EU) 2020/2184. The lifespan of the product is not guaranteed in the case of the use of groundwater, such as spring water or well water, the use of tap water when salt or other impurities are contained, nor in areas of acidic water quality. Maintenance and warranty costs related to these cases are the customer's responsibility.

Accessories	
CZ-RTW1	Optional remote controller for 2 zone control. K and L Series
CZ-TAW1C	Optional Wi-Fi or WLAN adapter for smart control via Panasonic Comfort Cloud and/or remote maintenance via Aquarea Service Cloud

Accessories	
CZ-TAW1-CBL	10 m extension cable for CZ-TAW1C
CZ-NS5P	PCB for advanced functions
PAW-A2W-RTWIRED	Room thermostat
PAW-A2W-RTWIREDLESS	Wireless LCD room thermostat



INTERNET CONTROL: Optional.

## NEW Aquarea High Performance All in One 260 L K Series. Single phase with Electrical Anode- R32

**Energy efficiency:** COP up to 5,33 / A+++ in heating at 35 °C and A+ in DHW / "A" water pump with variable speed / Stainless steel DHW tank with U-Vacua™ insulation panel / DHW COP up to 3,08.

**Flexibility:** 260 L DHW tank / 599 x 602 footprint / Easy access to hydraulic parts / Built-in magnetic water filter.

**Comfort:** Operation without backup heating at -25 °C / 60 °C hot water even at -10 °C outside temperature.

**Control:** Optimised user interface and improved features [2 zone control, bivalent control].

**Connectivity:** Optional Aquarea Smart and Service Cloud and integration into BMS projects.



		Single phase [power to indoor]				
Kit		KIT-ADC12K6E53	KIT-ADC16K6E53	KIT-ADC12K6E5AN3	KIT-ADC16K6E5AN3	
Heating capacity / COP [A +7 °C, W 35 °C]	kW / COP	12,10/4,78	16,00/4,31	12,10/4,78	16,00/4,31	
Heating capacity / COP [A +7 °C, W 55 °C]	kW / COP	12,00/2,96	14,70/2,72	12,00/2,96	14,70/2,72	
Heating capacity / COP [A +2 °C, W 35 °C]	kW / COP	11,50/3,44	13,00/3,18	11,50/3,44	13,00/3,18	
Heating capacity / COP [A +2 °C, W 55 °C]	kW / COP	9,20/2,25	10,00/2,24	9,20/2,25	10,00/2,24	
Heating capacity / COP [A -7 °C, W 35 °C]	kW / COP	10,10/2,74	11,70/2,61	10,10/2,74	11,70/2,61	
Heating capacity / COP [A -7 °C, W 55 °C]	kW / COP	8,40/1,97	9,10/1,85	8,40/1,97	9,10/1,85	
Cooling capacity / EER [A 35 °C, W 7 °C]	kW / EER	10,70/2,68	12,20/2,68	10,70/2,68	12,20/2,68	
Cooling capacity / EER [A 35 °C, W 18 °C]	kW / EER	10,70/3,92	13,00/3,80	10,70/3,92	13,00/3,80	
Heating average climate [W 35 °C / W 55 °C]	Seasonal energy efficiency	SCOP [ $\eta_{s, \text{H}}$ %]	4,58/3,33 [180/130]	4,46/3,40 [176/133]	4,58/3,33 [180/130]	4,46/3,40 [176/133]
	Energy class <sup>1)</sup>		A+++ / A++	A+++ / A++	A+++ / A++	A+++ / A++
Heating warm climate [W 35 °C / W 55 °C]	Seasonal energy efficiency	SCOP [ $\eta_{s, \text{W}}$ %]	6,47/4,34 [256/171]	6,20/4,30 [245/169]	6,47/4,34 [256/171]	6,20/4,30 [245/169]
	Energy class <sup>1)</sup>		A+++ / A+++	A+++ / A+++	A+++ / A+++	A+++ / A+++
Heating cold climate [W 35 °C / W 55 °C]	Seasonal energy efficiency	SCOP [ $\eta_{s, \text{C}}$ %]	4,31/3,26 [169/127]	4,28/3,10 [168/121]	4,31/3,26 [169/127]	4,28/3,10 [168/121]
	Energy class <sup>1)</sup>		A+++ to D	A++ / A++	A++ / A++	A++ / A+
<b>Indoor unit</b>		<b>WH-ADC0912K6E53</b>	<b>WH-ADC16K6E53</b>	<b>WH-ADC0912K6E5AN3</b>	<b>WH-ADC16K6E5AN3</b>	
Sound pressure	Heat / Cool	dB(A)	33/33	33/33	33/33	
Dimension	H x W x D	mm	2036 x 599 x 602	2036 x 599 x 602	2036 x 599 x 602	
Net weight		kg	119	119	120	
Water pipe connector		Inch	R 1½	R 1½	R 1½	
A class pump	Number of speeds		Variable speed	Variable speed	Variable speed	
	Input power	W	145	145	145	
Heating water flow [ $\Delta T=5$ K, 35 °C]		L/min	34,4	34,4	45,8	
Water volume		L	185	185	185	
Maximum DHW temperature		°C	65	65	65	
Material inside tank			Stainless steel	Stainless steel	Stainless steel	
Tapping profile according EN16147			L	L	L	
DHW tank ERP efficiency average / warm / cold <sup>2)</sup>		A+ to F	A+ / A / A	A+ / A / A	A+ / A / A	
DHW tank ERP average climate $\eta$ / COP <sub>DHW</sub>	$\eta_{\text{wh}} \%$ / COP <sub>DHW</sub>		100/2,50	100/2,50	100/2,50	
DHW tank ERP warm climate $\eta$ / COP <sub>DHW</sub>	$\eta_{\text{wh}} \%$ / COP <sub>DHW</sub>		116/2,90	116/2,90	116/2,90	
DHW tank ERP cold climate $\eta$ / COP <sub>DHW</sub>	$\eta_{\text{wh}} \%$ / COP <sub>DHW</sub>		80/2,00	80/2,00	80/2,00	
<b>Outdoor unit</b>		<b>WH-UDZ12KE5</b>	<b>WH-UDZ16KE5</b>	<b>WH-UDZ12KE5</b>	<b>WH-UDZ16KE5</b>	
Sound power <sup>3)</sup>	Heat	dB(A)	65	65	65	
Dimension / Net weight	H x W x D	mm / kg	1340 x 900 x 320 / 88	1340 x 900 x 320 / 88	1340 x 900 x 320 / 88	
Refrigerant (R32) / CO <sub>2</sub> Eq.		kg / T	1,6 / 1,080	1,6 / 1,080	1,6 / 1,080	
Piping diameter	Liquid / Gas	Inch (mm)	1/4 (6,35) / 1/2 (12,7)	1/4 (6,35) / 5/8 (15,88)	1/4 (6,35) / 1/2 (12,7)	
Pipe length range / Elevation difference [in / out]		m / m	3-30 [3-50] <sup>5)</sup> / 20 [30] <sup>5)</sup>	3-30 [3-50] <sup>5)</sup> / 20 [30] <sup>5)</sup>	3-30 [3-50] <sup>5)</sup> / 20 [30] <sup>5)</sup>	
Pre-charged pipe length / Additional gas amount		m / g/m	10/30	10/30	10/30	
Operating range - outdoor ambient	Heat	°C	-25 ~ +35	-25 ~ +35	-25 ~ +35	
	Cool	°C	+10 ~ +43	+10 ~ +43	+10 ~ +43	
Water outlet	Heat / Cool	°C	20 ~ 60 / 5 ~ 20	20 ~ 60 / 5 ~ 20	20 ~ 60 / 5 ~ 20	
<b>Electrical information</b>		<b>WH-ADC0912K6E53</b>	<b>WH-ADC16K6E53</b>	<b>WH-ADC0912K6E5AN3</b>	<b>WH-ADC16K6E5AN3</b>	
Electric backup heater		kW	6,00	6,00	6,00	
Recommended fuse <sup>5)</sup>		A	30/30	30/30	30/30	
Recommended minimum cable size, supply 1 / 2 <sup>5)</sup>		mm <sup>2</sup>	3x4,0 / 3x4,0	3x4,0 / 3x4,0	3x4,0 / 3x4,0	

1) Scale from A+++ to D. 2) Scale from A+ to F. 3) Sound power in accordance to 811/2013, 813/2013 and EN 12102-1:2017 at +7 °C. 4) Operation range down to -25 °C in heating with 3~40 m pipe length range, operation range down to -15 °C in heating with 3~50 m pipe length range. 5) Check local regulations. \* EER and COP calculation is based in accordance to EN 14511. \*\* This product is designed to comply with the European drinking water standard [EU] 2020/2184. The lifespan of the product is not guaranteed in the case of the use of groundwater, such as spring water or well water, the use of tap water when salt or other impurities are contained, nor in areas of acidic water quality. Maintenance and warranty costs related to these cases are the customer's responsibility.

Accessories	
<b>CZ-RTW1</b>	Optional remote controller for 2 zone control. K and L Series
<b>CZ-TAW1C</b>	Optional Wi-Fi or WLAN adapter for smart control via Panasonic Comfort Cloud and/or remote maintenance via Aquarea Service Cloud

Accessories	
<b>CZ-TAW1-CBL</b>	10 m extension cable for CZ-TAW1C
<b>CZ-NS5P</b>	PCB for advanced functions
<b>PAW-A2W-RTWIRED</b>	Room thermostat
<b>PAW-A2W-RTWIREDLESS</b>	Wireless LCD room thermostat



INTERNET CONTROL: Optional.

## Aquarea High Performance All in One 185 L K Series. Single phase 2 zones - R32

**Energy efficiency:** COP up to 5,33 / A+++ in heating at 35 °C and A+ in DHW / "A" water pump with variable speed / Stainless steel DHW tank with U-Vacua™ insulation panel / DHW COP up to 3,50.

**Flexibility:** 599 x 602 footprint / Easy access to hydraulic parts / Built-in magnetic water filter / 2 zone control.

**Comfort:** Operation without backup heating at -25 °C / 60 °C hot water even at -10 °C outside temperature.

**Control:** Optimised user interface and improved features (2 zone control, bivalent control).

**Connectivity:** Optional Aquarea Smart and Service Cloud and integration into BMS projects.



		Single phase (power to indoor)				
Kit		KIT-ADC03K3E5B	KIT-ADC05K3E5B	KIT-ADC07K3E5B	KIT-ADC09K3E5B	
Heating capacity / COP (A +7 °C, W 35 °C)	kW / COP	3,20/5,33	5,00/5,10	7,00/4,86	9,00/4,55	
Heating capacity / COP (A +7 °C, W 55 °C)	kW / COP	3,20/2,81	5,00/3,03	7,00/2,92	8,90/2,93	
Heating capacity / COP (A +2 °C, W 35 °C)	kW / COP	3,20/3,64	5,00/3,57	6,85/3,43	7,00/3,40	
Heating capacity / COP (A +2 °C, W 55 °C)	kW / COP	3,20/2,19	5,00/2,29	6,25/2,23	6,30/2,18	
Heating capacity / COP (A -7 °C, W 35 °C)	kW / COP	3,30/2,80	5,00/2,79	5,75/2,95	6,25/2,84	
Heating capacity / COP (A -7 °C, W 55 °C)	kW / COP	3,20/1,79	5,00/1,89	5,35/1,98	5,90/1,93	
Cooling capacity / EER (A 35 °C, W 7 °C)	kW / EER	3,20/3,52	5,00/3,05	6,70/3,03	8,20/2,72	
Cooling capacity / EER (A 35 °C, W 18 °C)	kW / EER	3,20/4,71	5,00/4,90	6,70/4,72	9,00/4,18	
Heating average climate (W 35 °C / W 55 °C)	Seasonal energy efficiency	SCOP (η <sub>s</sub> %)	5,07/3,47 [200/136]	5,12/3,63 [202/142]	4,90/3,62 [193/142]	4,44/3,41 [175/133]
	Energy class <sup>1)</sup>		A+++ to D	A+++/A++	A+++/A++	A+++/A++
Heating warm climate (W 35 °C / W 55 °C)	Seasonal energy efficiency	SCOP (η <sub>s</sub> %)	6,20/4,20 [245/165]	6,00/4,20 [237/165]	5,75/4,07 [227/160]	5,75/4,07 [227/160]
	Energy class <sup>1)</sup>		A+++ to D	A+++/A+++	A+++/A+++	A+++/A+++
Heating cold climate (W 35 °C / W 55 °C)	Seasonal energy efficiency	SCOP (η <sub>s</sub> %)	4,00/2,83 [157/110]	4,08/2,95 [160/115]	4,18/2,98 [164/116]	4,18/2,98 [164/116]
	Energy class <sup>1)</sup>		A+++ to D	A++/A+	A++/A+	A++/A+
<b>Indoor unit</b>		<b>WH-ADC0309K3E5B</b>	<b>WH-ADC0309K3E5B</b>	<b>WH-ADC0309K3E5B</b>	<b>WH-ADC0309K3E5B</b>	
Sound pressure	Heat / Cool	dB(A)	28/28	28/28	28/28	
Dimension	H x W x D	mm	1642 x 599 x 602	1642 x 599 x 602	1642 x 599 x 602	
Net weight		kg	109	109	109	
Water pipe connector		Inch	R 1¼	R 1¼	R 1¼	
A class pump	Number of speeds		Variable speed	Variable speed	Variable speed	
	Input power (Min/Max)	W	30/120	30/120	30/120	
Heating water flow (ΔT=5 K, 35 °C)		L/min	9,2	14,3	20,1	
Water volume		L	185	185	185	
Maximum DHW temperature		°C	65	65	65	
Material inside tank			Stainless steel	Stainless steel	Stainless steel	
Tapping profile according EN16147			L	L	L	
DHW tank ERP efficiency average / warm / cold <sup>2)</sup>		A+ to F	A+/A++/A	A+/A++/A	A+/A++/A	
DHW tank ERP average climate η / COPdHW	η <sub>wh</sub> % / COPdHW		128/3,20	140/3,50	140/3,50	
DHW tank ERP warm climate η / COPdHW	η <sub>wh</sub> % / COPdHW		154/3,86	160/4,00	160/4,00	
DHW tank ERP cold climate η / COPdHW	η <sub>wh</sub> % / COPdHW		99/2,48	112/2,80	112/2,80	
<b>Outdoor unit</b>		<b>WH-UDZ03KE5</b>	<b>WH-UDZ05KE5</b>	<b>WH-UDZ07KE5</b>	<b>WH-UDZ09KE5</b>	
Sound power <sup>3)</sup>	Heat	dB(A)	55	55	56	
Dimension / Net weight	H x W x D	mm / kg	622 x 824 x 298 / 37	795 x 875 x 380 / 55	795 x 875 x 380 / 55	
Refrigerant (R32) / CO <sub>2</sub> Eq.		kg / T	0,9/0,608	1,3/0,878	1,3/0,878	
Piping diameter	Liquid / Gas	Inch (mm)	1/4 (6,35) / 1/2 (12,70)	1/4 (6,35) / 5/8 (15,88)	1/4 (6,35) / 5/8 (15,88)	
Pipe length range / Elevation difference (in / out)		m / m	3 ~ 25 / 20	3 ~ 40 [3 ~ 50] <sup>4)</sup> / 30	3 ~ 40 [3 ~ 50] <sup>4)</sup> / 30	
Pre-charged pipe length / Additional gas amount		m / g/m	10 / 20	10 / 25	10 / 25	
Operating range - outdoor ambient	Heat	°C	-20 ~ +35	-25 ~ +35	-25 ~ +35	
	Cool	°C	+10 ~ +43	+10 ~ +43	+10 ~ +43	
Water outlet	Heat / Cool	°C	20 ~ 60 / 5 ~ 20	20 ~ 60 / 5 ~ 20	20 ~ 60 / 5 ~ 20	
<b>Electrical information</b>		<b>WH-ADC0309K3E5B</b>	<b>WH-ADC0309K3E5B</b>	<b>WH-ADC0309K3E5B</b>	<b>WH-ADC0309K3E5B</b>	
Electric backup heater		kW	3,00	3,00	3,00	
Recommended fuse <sup>5)</sup>		A	16/16	16/16	25/16	
Recommended minimum cable size, supply 1 / 2 <sup>5)</sup>		mm <sup>2</sup>	3x1,5/3x1,5	3x1,5/3x1,5	3x2,5/3x1,5	

1) Scale from A+++ to D. 2) Scale from A+ to F. 3) Sound power in accordance to 811/2013, 813/2013 and EN 12102-1:2017 at +7 °C. 4) Operation range down to -25 °C in heating with 3-40 m pipe length range, operation range down to -15 °C in heating with 3-50 m pipe length range. 5) Check local regulations. \* EER and COP calculation is based in accordance to EN 14511. \*\* This product is designed to comply with the European drinking water standard (EU) 2020/2184. The lifespan of the product is not guaranteed in the case of the use of groundwater, such as spring water or well water, the use of tap water when salt or other impurities are contained, nor in areas of acidic water quality. Maintenance and warranty costs related to these cases are the customer's responsibility.

Accessories	
<b>CZ-RTW1</b>	Optional remote controller for 2 zone control. K and L Series
<b>CZ-TAW1C</b>	Optional Wi-Fi or WLAN adapter for smart control via Panasonic Comfort Cloud and/or remote maintenance via Aquarea Service Cloud

Accessories	
<b>CZ-TAW1-CBL</b>	10 m extension cable for CZ-TAW1C
<b>CZ-NS5P</b>	PCB for advanced functions
<b>PAW-A2W-RTWIRED</b>	Room thermostat
<b>PAW-A2W-RTWIREDLESS</b>	Wireless LCD room thermostat



INTERNET CONTROL: Optional.

## Aquarea High Performance All in One 185 L K Series. Three phase - R32

**Energy efficiency:** A+++ in heating at 35 °C and A+ in DHW / "A" water pump with variable speed / Stainless steel DHW tank with U-Vacua™ insulation panel.

**Flexibility:** 599 x 602 footprint / Easy access to hydraulic parts / Built-in magnetic water filter.

**Comfort:** Operation without backup heating at -25 °C / 60 °C hot water even at -10 °C outside temperature.

**Control:** Optimised user interface and improved features (2 zone control, bivalent control).

**Connectivity:** Optional Aquarea Smart and Service Cloud and integration into BMS projects.



Three phase (power to indoor)					
Kit			KIT-ADC09K9E8	KIT-ADC12K9E8	KIT-ADC16K9E8
Heating capacity / COP (A +7 °C, W 35 °C)		kW / COP	9,00/4,90	12,10/4,78	16,00/4,31
Heating capacity / COP (A +7 °C, W 55 °C)		kW / COP	9,00/2,97	12,00/2,96	14,70/2,72
Heating capacity / COP (A +2 °C, W 35 °C)		kW / COP	9,00/3,63	11,50/3,44	13,20/3,28
Heating capacity / COP (A +2 °C, W 55 °C)		kW / COP	9,00/2,26	9,20/2,25	10,00/2,21
Heating capacity / COP (A -7 °C, W 35 °C)		kW / COP	9,00/2,88	10,10/2,74	11,60/2,57
Heating capacity / COP (A -7 °C, W 55 °C)		kW / COP	8,10/2,07	8,40/1,97	9,10/1,85
Cooling capacity / EER (A 35 °C, W 7 °C)		kW / EER	8,80/3,11	10,70/2,68	13,40/2,64
Cooling capacity / EER (A 35 °C, W 18 °C)		kW / EER	8,80/4,63	10,70/3,92	15,50/3,60
Heating average climate (W 35 °C / W 55 °C)	Seasonal energy efficiency	SCOP (η <sub>s</sub> %)	4,96/3,57(195/140)	4,58/3,33(180/130)	4,46/3,40(176/133)
	Energy class <sup>1)</sup>		A+++ / A++	A+++ / A++	A+++ / A++
Heating warm climate (W 35 °C / W 55 °C)	Seasonal energy efficiency	SCOP (η <sub>s</sub> %)	6,47/4,34(256/171)	6,47/4,34(256/171)	6,20/4,30(245/169)
	Energy class <sup>1)</sup>		A+++ / A+++	A+++ / A+++	A+++ / A+++
Heating cold climate (W 35 °C / W 55 °C)	Seasonal energy efficiency	SCOP (η <sub>s</sub> %)	4,31/3,26(169/127)	4,31/3,26(169/127)	4,28/3,10(168/121)
	Energy class <sup>1)</sup>		A++ / A++	A++ / A++	A++ / A+
<b>Indoor unit</b>			<b>WH-ADC0912K9E8</b>	<b>WH-ADC0912K9E8</b>	<b>WH-ADC16K9E8</b>
Sound pressure	Heat / Cool	dB(A)	33/33	33/33	33/33
Dimension	HxWxD	mm	1642x599x602	1642x599x602	1642x599x602
Net weight		kg	102	102	103
Water pipe connector		Inch	R 1½	R 1½	R 1½
A class pump	Number of speeds		Variable speed	Variable speed	Variable speed
	Input power	W	145	145	145
Heating water flow (ΔT=5 K, 35 °C)		L/min	25,8	34,4	45,9
Water volume		L	185	185	185
Maximum DHW temperature		°C	65	65	65
Material inside tank			Stainless steel	Stainless steel	Stainless steel
Tapping profile according EN16147			L	L	L
DHW tank ERP efficiency average / warm / cold <sup>2)</sup>			A/A+/A	A/A+/A	A/A+/A
DHW tank ERP average climate η / COPdHW		η <sub>wh</sub> % / COPdHW	100/2,50	100/2,50	96/2,40
DHW tank ERP warm climate η / COPdHW		η <sub>wh</sub> % / COPdHW	116/2,90	116/2,90	115/2,88
DHW tank ERP cold climate η / COPdHW		η <sub>wh</sub> % / COPdHW	80/2,00	80/2,00	76/1,90
<b>Outdoor unit</b>			<b>WH-UDZ09KE8</b>	<b>WH-UDZ12KE8</b>	<b>WH-UDZ16KE8</b>
Sound power <sup>3)</sup>	Heat	dB(A)	65	65	65
Dimension / Net weight	HxWxD	mm / kg	1340x900x320/90	1340x900x320/90	1340x900x320/103
Refrigerant (R32) / CO <sub>2</sub> Eq.		kg / T	1,60/1,080	1,60/1,080	1,83/1,235
Piping diameter	Liquid / Gas	Inch (mm)	1/4 (6,35) / 1/2 (12,70)	1/4 (6,35) / 1/2 (12,70)	1/4 (6,35) / 1/2 (12,70)
Pipe length range / Elevation difference (in / out)		m / m	3~30/20	3~30/20	3~30/20
Pre-charged pipe length / Additional gas amount		m / g/m	10/30	10/30	10/30
Operating range - outdoor ambient	Heat	°C	-25~+35	-25~+35	-25~+35
	Cool	°C	+10~+43	+10~+43	+10~+43
Water outlet <sup>4)</sup>	Heat / Cool	°C	20~60/5~20	20~60/5~20	20~60/5~20
<b>Electrical information</b>			<b>WH-ADC0912K9E8</b>	<b>WH-ADC0912K9E8</b>	<b>WH-ADC16K9E8</b>
Electric backup heater		kW	9,00	9,00	9,00
Recommended fuse <sup>5)</sup>		A	20/20	20/20	20/20
Recommended minimum cable size, supply 1 / 2 <sup>5)</sup>		mm <sup>2</sup>	5x1,5/5x1,5	5x1,5/5x1,5	5x2,5/5x1,5

1) Scale from A+++ to D. 2) Scale from A+ to F. 3) Sound power level in accordance to EN 12102 under conditions of the EN14825. 4) Between outdoor ambient -10 °C and -15 °C, the water outlet temperature gradually decreases from 60 °C to 55 °C. 5) Check local regulations. \* EER and COP calculation is based in accordance to EN 14511. \*\* This product is designed to comply with the European drinking water standard (EU) 2020/2184. The lifespan of the product is not guaranteed in the case of the use of groundwater, such as spring water or well water, the use of tap water when salt or other impurities are contained, nor in areas of acidic water quality. Maintenance and warranty costs related to these cases are the customer's responsibility.

Accessories	
<b>CZ-RTW1</b>	Optional remote controller for 2 zone control. K and L Series
<b>CZ-TAW1C</b>	Optional Wi-Fi or WLAN adapter for smart control via Panasonic Comfort Cloud and/or remote maintenance via Aquarea Service Cloud

Accessories	
<b>CZ-TAW1-CBL</b>	10 m extension cable for CZ-TAW1C
<b>CZ-NS5P</b>	PCB for advanced functions
<b>PAW-A2W-RTWIRED</b>	Room thermostat
<b>PAW-A2W-RTWIRELESS</b>	Wireless LCD room thermostat



INTERNET CONTROL: Optional.

## Aquarea High Performance All in One 185 L K Series. Three phase with Electrical Anode - R32

**Energy efficiency:** A+++ in heating at 35 °C and A+ in DHW / "A" water pump with variable speed / Stainless steel DHW tank with U-Vacua™ insulation panel.

**Flexibility:** 599 x 602 footprint / Easy access to hydraulic parts / Built-in magnetic water filter / Installation in harsh water conditions.

**Comfort:** Operation without backup heating at -25 °C / 60 °C hot water even at -10 °C outside temperature.

**Control:** Optimised user interface and improved features (2 zone control, bivalent control).

**Connectivity:** Optional Aquarea Smart and Service Cloud and integration into BMS projects.



		Three phase (power to indoor)			
Kit		KIT-ADC09K9E8AN	KIT-ADC12K9E8AN	KIT-ADC16K9E8AN	
Heating capacity / COP (A +7 °C, W 35 °C)	kW / COP	9,00/4,90	12,10/4,78	16,00/4,31	
Heating capacity / COP (A +7 °C, W 55 °C)	kW / COP	9,00/2,97	12,00/2,96	14,70/2,72	
Heating capacity / COP (A +2 °C, W 35 °C)	kW / COP	9,00/3,63	11,50/3,44	13,20/3,28	
Heating capacity / COP (A +2 °C, W 55 °C)	kW / COP	9,00/2,26	9,20/2,25	10,00/2,21	
Heating capacity / COP (A -7 °C, W 35 °C)	kW / COP	9,00/2,88	10,10/2,74	11,60/2,57	
Heating capacity / COP (A -7 °C, W 55 °C)	kW / COP	8,10/2,07	8,40/1,97	9,10/1,85	
Cooling capacity / EER (A 35 °C, W 7 °C)	kW / EER	8,80/3,11	10,70/2,68	13,40/2,64	
Cooling capacity / EER (A 35 °C, W 18 °C)	kW / EER	8,80/4,63	10,70/3,92	15,50/3,60	
Heating average climate (W 35 °C / W 55 °C)	Seasonal energy efficiency SCOP (η <sub>s</sub> %)	4,96/3,57(195/140)	4,58/3,33(180/130)	4,46/3,40(176/133)	
	Energy class <sup>1)</sup>	A+++ to D	A+++/A++	A+++/A++	
Heating warm climate (W 35 °C / W 55 °C)	Seasonal energy efficiency SCOP (η <sub>s</sub> %)	6,47/4,34(256/171)	6,47/4,34(256/171)	6,20/4,30(245/169)	
	Energy class <sup>1)</sup>	A+++ to D	A+++/A+++	A+++/A+++	
Heating cold climate (W 35 °C / W 55 °C)	Seasonal energy efficiency SCOP (η <sub>s</sub> %)	4,31/3,26(169/127)	4,31/3,26(169/127)	4,28/3,10(168/121)	
	Energy class <sup>1)</sup>	A+++ to D	A++/A++	A++/A+	
<b>Indoor unit</b>		<b>WH-ADC0912K9E8AN</b>	<b>WH-ADC0912K9E8AN</b>	<b>WH-ADC16K9E8AN</b>	
Sound pressure	Heat / Cool	dB(A) 33/33		33/33	
Dimension	H x W x D	mm 1642 x 599 x 602		1642 x 599 x 602	
Net weight		kg 102		103	
Water pipe connector		Inch R 1¼		R 1¼	
A class pump	Number of speeds	Variable speed		Variable speed	
	Input power	W 145		145	
Heating water flow (ΔT=5 K, 35 °C)	L/min	25,8		34,4	
Water volume	L	185		185	
Maximum DHW temperature	°C	65		65	
Material inside tank		Stainless steel		Stainless steel	
Tapping profile according EN16147		L		L	
DHW tank ERP efficiency average / warm / cold <sup>2)</sup>	A+ to F	A/A+/A		A/A+/A	
DHW tank ERP average climate η / COPdHWH	η <sub>wh</sub> %/COPdHWH	100/2,50		96/2,40	
DHW tank ERP warm climate η / COPdHWH	η <sub>wh</sub> %/COPdHWH	116/2,90		115/2,88	
DHW tank ERP cold climate η / COPdHWH	η <sub>wh</sub> %/COPdHWH	80/2,00		76/1,90	
<b>Outdoor unit</b>		<b>WH-UDZ09KE8</b>	<b>WH-UDZ12KE8</b>	<b>WH-UDZ16KE8</b>	
Sound power <sup>3)</sup>	Heat	dB(A) 65		65	
Dimension / Net weight	H x W x D	mm / kg 1340 x 900 x 320/90		1340 x 900 x 320/103	
Refrigerant (R32) / CO <sub>2</sub> Eq.	kg / T	1,60/1,080		1,83/1,235	
Piping diameter	Liquid / Gas	Inch (mm) 1/4(6,35)/1/2(12,70)		1/4(6,35)/1/2(12,70)	
Pipe length range / Elevation difference (in / out)	m / m	3-30/20		3-30/20	
Pre-charged pipe length / Additional gas amount	m / g/m	10/30		10/30	
Operating range - outdoor ambient	Heat	°C -25 ~ +35		-25 ~ +35	
	Cool	°C +10 ~ +43		+10 ~ +43	
Water outlet <sup>4)</sup>	Heat / Cool	°C 20 ~ 60/5 ~ 20		20 ~ 60/5 ~ 20	
<b>Electrical information</b>		<b>WH-ADC0912K9E8AN3</b>	<b>WH-ADC0912K9E8AN3</b>	<b>WH-ADC16K9E8AN3</b>	
Electric backup heater	kW	9,00		9,00	
Recommended fuse <sup>5)</sup>	A	20/20		20/20	
Recommended minimum cable size, supply 1 / 2 <sup>5)</sup>	mm <sup>2</sup>	5x1,5/5x1,5		5x1,5/5x1,5	

1) Scale from A+++ to D. 2) Scale from A+ to F. 3) Sound power level in accordance to EN 12102 under conditions of the EN14825. 4) Between outdoor ambient -10 °C and -15 °C, the water outlet temperature gradually decreases from 60 °C to 55 °C. 5) Check local regulations. \* EER and COP calculation is based in accordance to EN 14511. \*\* This product is designed to comply with the European drinking water standard (EU) 2020/2184. The lifespan of the product is not guaranteed in the case of the use of groundwater, such as spring water or well water, the use of tap water when salt or other impurities are contained, nor in areas of acidic water quality. Maintenance and warranty costs related to these cases are the customer's responsibility.

Accessories	
<b>CZ-RTW1</b>	Optional remote controller for 2 zone control. K and L Series
<b>CZ-TAW1C</b>	Optional Wi-Fi or WLAN adapter for smart control via Panasonic Comfort Cloud and/or remote maintenance via Aquarea Service Cloud

Accessories	
<b>CZ-TAW1-CBL</b>	10 m extension cable for CZ-TAW1C
<b>CZ-NS5P</b>	PCB for advanced functions
<b>PAW-A2W-RTWIRED</b>	Room thermostat
<b>PAW-A2W-RTWIREDLESS</b>	Wireless LCD room thermostat



INTERNET CONTROL: Optional.

## NEW Aquarea High Performance All in One 260 L K Series. Three phase - R32

**Energy efficiency:** A+++ in heating at 35 °C and A+ in DHW / "A" water pump with variable speed / Stainless steel DHW tank with U-Vacua™ insulation panel.

**Flexibility:** 260 L DHW tank / 599 x 602 footprint / Easy access to hydraulic parts / Built-in magnetic water filter.

**Comfort:** Operation without backup heating at -25 °C / 60 °C hot water even at -10 °C outside temperature.

**Control:** Optimised user interface and improved features (2 zone control, bivalent control).

**Connectivity:** Optional Aquarea Smart and Service Cloud and integration into BMS projects.

New  
2025

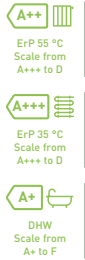

				Three phase (power to indoor)			
Kit		KIT-ADC09K9E83		KIT-ADC12K9E83		KIT-ADC16K9E83	
Heating capacity / COP (A +7 °C, W 35 °C)		kW / COP		12,10/4,78		16,00/4,31	
Heating capacity / COP (A +7 °C, W 55 °C)		kW / COP		12,00/2,97		14,70/2,72	
Heating capacity / COP (A +2 °C, W 35 °C)		kW / COP		11,50/3,44		13,20/3,28	
Heating capacity / COP (A +2 °C, W 55 °C)		kW / COP		9,20/2,25		10,00/2,21	
Heating capacity / COP (A -7 °C, W 35 °C)		kW / COP		10,10/2,74		11,60/2,57	
Heating capacity / COP (A -7 °C, W 55 °C)		kW / COP		8,40/1,97		9,10/1,85	
Cooling capacity / EER (A 35 °C, W 7 °C)		kW / EER		10,70/2,68		13,40/2,64	
Cooling capacity / EER (A 35 °C, W 18 °C)		kW / EER		10,70/3,92		15,50/3,60	
Heating average climate (W 35 °C / W 55 °C)		Seasonal energy efficiency	SCOP (η <sub>s</sub> %)	4,96/3,57(195/140)		4,58/3,33(180/130)	
		Energy class <sup>1)</sup>		A+++/A++		A+++/A++	
Heating warm climate (W 35 °C / W 55 °C)		Seasonal energy efficiency	SCOP (η <sub>s</sub> %)	6,47/4,34(256/171)		6,20/4,30(245/169)	
		Energy class <sup>1)</sup>		A+++/A+++		A+++/A+++	
Heating cold climate (W 35 °C / W 55 °C)		Seasonal energy efficiency	SCOP (η <sub>s</sub> %)	4,31/3,26(169/127)		4,28/3,10(168/121)	
		Energy class <sup>1)</sup>		A++/A++		A++/A+	
<b>Indoor unit</b>		<b>WH-ADC0912K9E83</b>		<b>WH-ADC0912K9E83</b>		<b>WH-ADC16K9E83</b>	
Sound pressure		Heat / Cool	dB(A)	33/33		33/33	
Dimension		HxWxD	mm	2036x599x602		2036x599x602	
Net weight			kg	119		120	
Water pipe connector			Inch	R 1½		R 1½	
A class pump		Number of speeds		Variable speed		Variable speed	
		Input power	W	145		145	
Heating water flow (ΔT=5 K, 35 °C)			L/min	25,8		34,4	
Water volume			L	260		260	
Maximum DHW temperature			°C	65		65	
Material inside tank				Stainless steel		Stainless steel	
Tapping profile according EN16147				XL		XL	
DHW tank ERP efficiency average / warm / cold <sup>2)</sup>				A+/A+/A		A+/A+/A	
DHW tank ERP average climate η / COPdHW			η <sub>wh</sub> %/COPdHW	123/3,08		98/2,45	
DHW tank ERP warm climate η / COPdHW			η <sub>wh</sub> %/COPdHW	134/3,35		123/3,08	
DHW tank ERP cold climate η / COPdHW			η <sub>wh</sub> %/COPdHW	94/2,35		80/2,00	
<b>Outdoor unit</b>		<b>WH-UDZ09KE8</b>		<b>WH-UDZ12KE8</b>		<b>WH-UDZ16KE8</b>	
Sound power <sup>3)</sup>		Heat	dB(A)	65		65	
Dimension / Net weight		HxWxD	mm / kg	1340x900x320/90		1340x900x320/103	
Refrigerant (R32) / CO <sub>2</sub> Eq.			kg / T	1,60/1,080		1,83/1,235	
Piping diameter		Liquid / Gas	Inch (mm)	1/4 (6,35)/1/2 (12,70)		1/4 (6,35)/1/2 (12,70)	
Pipe length range / Elevation difference (in / out)			m / m	3~30/20		3~30/20	
Pre-charged pipe length / Additional gas amount			m / g/m	10/30		10/30	
Operating range - outdoor ambient		Heat	°C	-25~+35		-25~+35	
		Cool	°C	+10~+43		+10~+43	
Water outlet		Heat / Cool	°C	20~60/5~20		20~60/5~20	
<b>Electrical information</b>		<b>WH-ADC0912K9E83</b>		<b>WH-ADC0912K9E83</b>		<b>WH-ADC16K9E83</b>	
Electric backup heater			kW	9,00		9,00	
Recommended fuse <sup>5)</sup>			A	20/20		20/20	
Recommended minimum cable size, supply 1 / 2 <sup>5)</sup>			mm <sup>2</sup>	5x1,5/5x1,5		5x1,5/5x1,5	

1) Scale from A+++ to D. 2) Scale from A+ to F. 3) Sound power in accordance to 811/2013, 813/2013 and EN 12102-1:2017 at +7 °C. 4) Operation range down to -25 °C in heating with 3~40 m pipe length range, operation range down to -15 °C in heating with 3~50 m pipe length range. 5) Check local regulations. \* EER and COP calculation is based in accordance to EN 14511. \*\* This product is designed to comply with the European drinking water standard (EU) 2020/2184. The lifespan of the product is not guaranteed in the case of the use of groundwater, such as spring water or well water, the use of tap water when salt or other impurities are contained, nor in areas of acidic water quality. Maintenance and warranty costs related to these cases are the customer's responsibility.

Accessories	
<b>CZ-RTW1</b>	Optional remote controller for 2 zone control. K and L Series
<b>CZ-TAW1C</b>	Optional Wi-Fi or WLAN adapter for smart control via Panasonic Comfort Cloud and/or remote maintenance via Aquarea Service Cloud

Accessories	
<b>CZ-TAW1-CBL</b>	10 m extension cable for CZ-TAW1C
<b>CZ-NS5P</b>	PCB for advanced functions
<b>PAW-A2W-RTWIRED</b>	Room thermostat
<b>PAW-A2W-RTWIRELESS</b>	Wireless LCD room thermostat



INTERNET CONTROL: Optional.



## NEW Aquarea High Performance All in One 260 L K Series. Three phase with Electrical Anode - R32

**Energy efficiency:** A+++ in heating at 35 °C and A+ in DHW / "A" water pump with variable speed / Stainless steel DHW tank with U-Vacua™ insulation panel.

**Flexibility:** 260 L DHW tank / 599 x 602 footprint / Easy access to hydraulic parts / Built-in magnetic water filter / Installation in harsh water conditions.

**Comfort:** Operation without backup heating at -25 °C / 60 °C hot water even at -10 °C outside temperature.

**Control:** Optimised user interface and improved features (2 zone control, bivalent control).

**Connectivity:** Optional Aquarea Smart and Service Cloud and integration into BMS projects.



		Three phase (power to indoor)			
Kit		KIT-ADC09K9E8AN3	KIT-ADC12K9E8AN3	KIT-ADC16K9E8AN3	
Heating capacity / COP (A +7 °C, W 35 °C)	kW / COP	9,00/4,90	12,10/4,78	16,00/4,31	
Heating capacity / COP (A +7 °C, W 55 °C)	kW / COP	9,00/2,97	12,00/2,96	14,70/2,72	
Heating capacity / COP (A +2 °C, W 35 °C)	kW / COP	9,00/3,63	11,50/3,44	13,20/3,28	
Heating capacity / COP (A +2 °C, W 55 °C)	kW / COP	9,00/2,26	9,20/2,25	10,00/2,21	
Heating capacity / COP (A -7 °C, W 35 °C)	kW / COP	9,00/2,88	10,10/2,74	11,60/2,57	
Heating capacity / COP (A -7 °C, W 55 °C)	kW / COP	8,10/2,07	8,40/1,97	9,10/1,85	
Cooling capacity / EER (A 35 °C, W 7 °C)	kW / EER	8,80/3,11	10,70/2,68	13,40/2,64	
Cooling capacity / EER (A 35 °C, W 18 °C)	kW / EER	8,80/4,63	10,70/3,92	15,50/3,60	
Heating average climate (W 35 °C / W 55 °C)	Seasonal energy efficiency	SCOP (η <sub>s</sub> %)	4,96/3,57(195/140)	4,58/3,33(180/130)	4,46/3,40(176/133)
	Energy class <sup>1)</sup>	A+++ to D	A+++/A++	A+++/A++	A+++/A++
Heating warm climate (W 35 °C / W 55 °C)	Seasonal energy efficiency	SCOP (η <sub>s</sub> %)	6,47/4,34(256/171)	6,47/4,34(256/171)	6,20/4,30(245/169)
	Energy class <sup>1)</sup>	A+++ to D	A+++/A+++	A+++/A+++	A+++/A+++
Heating cold climate (W 35 °C / W 55 °C)	Seasonal energy efficiency	SCOP (η <sub>s</sub> %)	4,31/3,26(169/127)	4,31/3,26(169/127)	4,28/3,10(168/121)
	Energy class <sup>1)</sup>	A+++ to D	A++/A++	A++/A++	A++/A+
<b>Indoor unit</b>		<b>WH-ADC0912K9E8AN3</b>	<b>WH-ADC0912K9E8AN3</b>	<b>WH-ADC16K9E8AN3</b>	
Sound pressure	Heat / Cool	dB(A)	33/33	33/33	33/33
Dimension	H x W x D	mm	2036 x 599 x 602	2036 x 599 x 602	2036 x 599 x 602
Net weight		kg	119	119	120
Water pipe connector		Inch	R 1¼	R 1¼	R 1¼
A class pump	Number of speeds		Variable speed	Variable speed	Variable speed
	Input power	W	145	145	145
Heating water flow (ΔT=5 K, 35 °C)		L/min	25,8	34,4	45,9
Water volume		L	260	260	260
Maximum DHW temperature		°C	65	65	65
Material inside tank			Stainless steel	Stainless steel	Stainless steel
Tapping profile according EN16147			XL	XL	XL
DHW tank ERP efficiency average / warm / cold <sup>2)</sup>	A+ to F	A+/A+/A	A+/A+/A	A+/A+/A	
DHW tank ERP average climate η / COPdHW	η <sub>wh</sub> %/COPdHW	123/3,08	123/3,08	98/2,45	
DHW tank ERP warm climate η / COPdHW	η <sub>wh</sub> %/COPdHW	134/3,35	134/3,35	123/3,08	
DHW tank ERP cold climate η / COPdHW	η <sub>wh</sub> %/COPdHW	94/2,35	94/2,35	80/2,00	
<b>Outdoor unit</b>		<b>WH-UDZ09KE8</b>	<b>WH-UDZ12KE8</b>	<b>WH-UDZ16KE8</b>	
Sound power <sup>3)</sup>	Heat	dB(A)	65	65	65
Dimension / Net weight	H x W x D	mm / kg	1340 x 900 x 320/90	1340 x 900 x 320/90	1340 x 900 x 320/103
Refrigerant (R32) / CO <sub>2</sub> Eq.		kg / T	1,60/1,080	1,60/1,080	1,83/1,235
Piping diameter	Liquid / Gas	Inch (mm)	1/4(6,35)/1/2(12,70)	1/4(6,35)/1/2(12,70)	1/4(6,35)/1/2(12,70)
Pipe length range / Elevation difference (in / out)		m / m	3-30/20	3-30/20	3-30/20
Pre-charged pipe length / Additional gas amount		m / g/m	10/30	10/30	10/30
Operating range - outdoor ambient	Heat	°C	-25 ~ +35	-25 ~ +35	-25 ~ +35
	Cool	°C	+10 ~ +43	+10 ~ +43	+10 ~ +43
Water outlet	Heat / Cool	°C	20 ~ 60/5 ~ 20	20 ~ 60/5 ~ 20	20 ~ 60/5 ~ 20
<b>Electrical information</b>		<b>WH-ADC0912K9E8AN3</b>	<b>WH-ADC0912K9E8AN3</b>	<b>WH-ADC16K9E8AN3</b>	
Electric backup heater	kW	9,00	9,00	9,00	
Recommended fuse <sup>5)</sup>	A	20/20	20/20	20/20	
Recommended minimum cable size, supply 1 / 2 <sup>5)</sup>	mm <sup>2</sup>	5x1,5/5x1,5	5x1,5/5x1,5	5x2,5/5x1,5	

1) Scale from A+++ to D. 2) Scale from A+ to F. 3) Sound power in accordance to 811/2013, 813/2013 and EN 12102-1:2017 at +7 °C. 4) Operation range down to -25 °C in heating with 3-40 m pipe length range, operation range down to -15 °C in heating with 3-50 m pipe length range. 5) Check local regulations. \* EER and COP calculation is based in accordance to EN 14511. \*\* This product is designed to comply with the European drinking water standard (EU) 2020/2184. The lifespan of the product is not guaranteed in the case of the use of groundwater, such as spring water or well water, the use of tap water when salt or other impurities are contained, nor in areas of acidic water quality. Maintenance and warranty costs related to these cases are the customer's responsibility.

Accessories	
<b>CZ-RTW1</b>	Optional remote controller for 2 zone control. K and L Series
<b>CZ-TAW1C</b>	Optional Wi-Fi or WLAN adapter for smart control via Panasonic Comfort Cloud and/or remote maintenance via Aquarea Service Cloud

Accessories	
<b>CZ-TAW1-CBL</b>	10 m extension cable for CZ-TAW1C
<b>CZ-NS5P</b>	PCB for advanced functions
<b>PAW-A2W-RTWIRED</b>	Room thermostat
<b>PAW-A2W-RTWIREDLESS</b>	Wireless LCD room thermostat



INTERNET CONTROL: Optional.

**Aquarea High Performance Bi-bloc K Series. Single phase - SDC · R32**

**Energy efficiency:** COP up to 5,33 / A+++ in heating at 35 °C / "A" water pump with variable speed / Built-in flow meter.

**Flexibility:** Long piping lengths / Built-in magnetic water filter.

**Comfort:** Operation without backup heating at -25 °C / 60 °C hot water even at -10 °C outside temperature.

**Control:** Optimised user interface and improved features [2 zone control, bivalent control].

**Connectivity:** Optional Aquarea Smart and Service Cloud and integration into BMS projects.



		Single phase (power to indoor)									
Kit 3 kW electric heater		KIT-WC03K3E5	KIT-WC05K3E5	KIT-WC07K3E5	KIT-WC09K3E5	—					
Kit 6 kW electric heater		KIT-WC03K6E5	KIT-WC05K6E5	KIT-WC07K6E5	KIT-WC09K6E5	KIT-WC12K6E5	KIT-WC16K6E5				
Heating capacity / COP (A +7 °C, W 35 °C)	kW / COP	3,20/5,33	5,00/5,10	7,00/4,86	9,00/4,55	12,10/4,78	16,00/4,31				
Heating capacity / COP (A +7 °C, W 55 °C)	kW / COP	3,20/2,81	5,00/3,03	7,00/2,92	8,90/2,93	12,00/2,96	14,70/2,72				
Heating capacity / COP (A +2 °C, W 35 °C)	kW / COP	3,20/3,64	5,00/3,57	6,85/3,43	7,00/3,40	11,50/3,44	13,00/3,18				
Heating capacity / COP (A +2 °C, W 55 °C)	kW / COP	3,20/2,19	5,00/2,29	6,25/2,23	6,30/2,18	9,20/2,25	10,00/2,24				
Heating capacity / COP (A -7 °C, W 35 °C)	kW / COP	3,30/2,80	5,00/2,79	5,75/2,95	6,25/2,84	10,10/2,74	11,70/2,61				
Heating capacity / COP (A -7 °C, W 55 °C)	kW / COP	3,20/1,79	5,00/1,89	5,35/1,98	5,90/1,93	8,40/1,97	9,10/1,85				
Cooling capacity / EER (A 35 °C, W 7 °C)	kW / EER	3,20/3,52	5,00/3,05	6,70/3,03	8,20/2,72	10,70/2,68	12,20/2,68				
Cooling capacity / EER (A 35 °C, W 18 °C)	kW / EER	3,20/4,71	5,00/4,90	6,70/4,72	9,00/4,18	10,70/3,92	13,00/3,80				
Heating average climate (W 35 °C / W 55 °C)	Seasonal energy efficiency	SCOP (η <sub>s</sub> %)	5,07/3,47(200/136)	5,12/3,63(202/142)	4,90/3,62(193/142)	4,44/3,41(175/133)	4,58/3,33(180/130)	4,46/3,40(176/133)			
	Energy class <sup>1)</sup>		A+++ to D	A+++ / A++	A+++ / A++	A+++ / A++	A+++ / A++	A+++ / A++			
Heating warm climate (W 35 °C / W 55 °C)	Seasonal energy efficiency	SCOP (η <sub>s</sub> %)	6,20/4,20(245/165)	6,00/4,20(237/165)	5,75/4,07(227/160)	5,75/4,07(227/160)	6,47/4,34(256/171)	6,20/4,30(245/169)			
	Energy class <sup>1)</sup>		A+++ to D	A+++ / A+++	A+++ / A+++	A+++ / A+++	A+++ / A+++	A+++ / A+++			
Heating cold climate (W 35 °C / W 55 °C)	Seasonal energy efficiency	SCOP (η <sub>s</sub> %)	4,00/2,83(157/110)	4,08/2,95(160/115)	4,18/2,98(164/116)	4,18/2,98(164/116)	4,31/3,26(169/127)	4,28/3,10(168/121)			
	Energy class <sup>1)</sup>		A+++ to D	A++ / A+	A++ / A+	A++ / A+	A++ / A++	A++ / A+			
<b>Indoor unit 3 kW electric heater</b>		<b>WH-</b>	<b>SDC0309K3E5</b>	<b>SDC0309K3E5</b>	<b>SDC0309K3E5</b>	<b>SDC0309K3E5</b>	—				
<b>Indoor unit 6 kW electric heater</b>		<b>WH-</b>	<b>SDC0309K6E5</b>	<b>SDC0309K6E5</b>	<b>SDC0309K6E5</b>	<b>SDC0309K6E5</b>	<b>SDC12K6E5</b>	<b>SDC16K6E5</b>			
Sound pressure	Heat / Cool	dB(A)	28/28	28/28	30/30	30/31	33/33	33/33			
Dimension	H x W x D	mm	892 x 500 x 348	892 x 500 x 348	892 x 500 x 348	892 x 500 x 348	892 x 500 x 348	892 x 500 x 348			
Net weight 3 kW / 6 kW		kg	40/41	40/41	40/41	40/41	41	41			
Water pipe connector		Inch	R 1 1/4	R 1 1/4	R 1 1/4	R 1 1/4	R 1 1/4	R 1 1/4			
A class pump	Number of speeds		Variable speed	Variable speed	Variable speed	Variable speed	Variable speed	Variable speed			
	Input power	W	145	145	145	145	145	145			
Heating water flow (ΔT=5 K, 35 °C)		L/min	9,2	14,3	20,1	25,8	34,4	45,8			
<b>Outdoor unit</b>			<b>WH-UDZ03KE5</b>	<b>WH-UDZ05KE5</b>	<b>WH-UDZ07KE5</b>	<b>WH-UDZ09KE5</b>	<b>WH-UDZ12KE5</b>	<b>WH-UDZ16KE5</b>			
Sound power <sup>2)</sup>	Heat	dB(A)	55	55	56	56	65	65			
Dimension	H x W x D	mm	622 x 824 x 298	795 x 875 x 380	795 x 875 x 380	795 x 875 x 380	1340 x 900 x 320	1340 x 900 x 320			
Net weight		kg	37	55	55	55	88	88			
Refrigerant (R32) / CO <sub>2</sub> Eq.		kg / T	0,9/0,608	1,3/0,878	1,3/0,878	1,3/0,878	1,6/1,080	1,6/1,080			
Piping diameter	Liquid / Gas	Inch (mm)	1/4(6,35)/1/2(12,70)	1/4(6,35)/5/8(15,88)	1/4(6,35)/5/8(15,88)	1/4(6,35)/5/8(15,88)	1/4(6,35)/1/2(12,7)	1/4(6,35)/5/8(15,88)			
Pipe length range		m	3 ~ 25	3 ~ 40 [3 ~ 50] <sup>3)</sup>	3 ~ 40 [3 ~ 50] <sup>3)</sup>	3 ~ 40 [3 ~ 50] <sup>3)</sup>	3 ~ 30	3 ~ 30			
Elevation difference (in / out)		m	20	30	30	30	20	20			
Pre-charged pipe length		m	10	10	10	10	10	10			
Additional gas amount		g/m	20	25	25	25	30	30			
Operating range - outdoor ambient	Heat	°C	-20 ~ +35	-25 ~ +35	-25 ~ +35	-25 ~ +35	-25 ~ +35	-25 ~ +35			
	Cool	°C	+10 ~ +43	+10 ~ +43	+10 ~ +43	+10 ~ +43	+10 ~ +43	+10 ~ +43			
Water outlet <sup>4)</sup>	Heat / Cool	°C	20 ~ 60/5 ~ 20	20 ~ 60/5 ~ 20	20 ~ 60/5 ~ 20	20 ~ 60/5 ~ 20	20 ~ 60/5 ~ 20	20 ~ 60/5 ~ 20			
<b>Electrical information</b>		<b>Heater</b>	<b>3 kW</b>	<b>6 kW</b>	<b>3 kW</b>	<b>6 kW</b>	<b>3 kW</b>	<b>6 kW</b>	<b>6 kW</b>	<b>6 kW</b>	<b>6 kW</b>
Electric backup heater		kW	3,00	6,00	3,00	6,00	3,00	6,00	6,00	6,00	6,00
Recommended fuse <sup>5)</sup>		A	16/16	16/30	16/16	16/30	25/16	25/30	25/16	25/30	30/30
Recommended minimum cable size, supply 1 / 2 <sup>5)</sup>		mm <sup>2</sup>	3x1,5/ 3x1,5	3x1,5/ 3x4,0	3x1,5/ 3x1,5	3x1,5/ 3x4,0	3x2,5/ 3x4,0	3x2,5/ 3x4,0	3x2,5/ 3x4,0	3x4,0/3x4,0	3x4,0/3x4,0

1) Scale from A+++ to D. 2) Sound power level in accordance to EN 12102 under conditions of the EN14825. 3) Operation range down to -25 °C in heating with 3 ~ 40 m pipe length range, operation range down to -15 °C in heating with 3 ~ 50 m pipe length range. 4) Between outdoor ambient -10 °C and -15 °C, the water outlet temperature gradually decreases from 60 °C to 55 °C. 5) Check local regulations. \* EER and COP calculation is based in accordance to EN 14511. \*\* This product is designed to comply with the European drinking water standard (EU) 2020/2184. The lifespan of the product is not guaranteed in the case of the use of groundwater, such as spring water or well water, the use of tap water when salt or other impurities are contained, nor in areas of acidic water quality. Maintenance and warranty costs related to these cases are the customer's responsibility.

Accessories	
<b>CZ-RTW1</b>	Optional remote controller for 2 zone control. K and L Series
<b>PAW-TD20C1E5-1</b>	Tank 200 L - Stainless steel
<b>PAW-TD30C1E5-1</b>	Tank 300 L - Stainless steel
<b>PAW-TA20C1E5STD</b>	Tank 200 L - Enamelled
<b>PAW-TA30C1E5STD</b>	Tank 300 L - Enamelled
<b>PAW-3WYVLV-HW</b>	3 way valve for DHW tanks
<b>CZ-NV2</b>	3 way valve kit to fit inside the hydrokit. K and L Series

Accessories	
<b>PAW-BTANK50L-2</b>	Buffer tank 50 L
<b>CZ-TAW1C</b>	Optional Wi-Fi or WLAN adapter for smart control via Panasonic Comfort Cloud and/or remote maintenance via Aquarea Service Cloud
<b>CZ-TAW1-CBL</b>	10 m extension cable for CZ-TAW1C
<b>CZ-NS5P</b>	PCB for advanced functions
<b>PAW-A2W-RTWIRED</b>	Room thermostat
<b>PAW-A2W-RTWIREDLESS</b>	Wireless LCD room thermostat



INTERNET CONTROL: Optional.

**Aquarea High Performance Bi-bloc K Series. Three phase - SDC · R32**

**Energy efficiency:** A+++ in heating at 35 °C / "A" water pump with variable speed / Built-in flow meter.

**Flexibility:** Long piping lengths / Built-in magnetic water filter.

**Comfort:** Operation without backup heating at -25 °C / 60 °C hot water even at -10 °C outside temperature.

**Control:** Optimised user interface and improved features (2 zone control, bivalent control).

**Connectivity:** Optional Aquarea Smart and Service Cloud and integration into BMS projects.



				Three phase (power to indoor)			
Kit 3 kW electric heater		KIT-WC09K3E8		—		—	
Kit 9 kW electric heater		KIT-WC09K9E8		KIT-WC12K9E8		KIT-WC16K9E8	
Heating capacity / COP (A +7 °C, W 35 °C)	kW / COP	9,00 / 4,90		12,10 / 4,78		16,00 / 4,31	
Heating capacity / COP (A +7 °C, W 55 °C)	kW / COP	9,00 / 2,97		12,00 / 2,96		14,70 / 2,72	
Heating capacity / COP (A +2 °C, W 35 °C)	kW / COP	9,00 / 3,63		11,50 / 3,44		13,20 / 3,28	
Heating capacity / COP (A +2 °C, W 55 °C)	kW / COP	9,00 / 2,26		9,20 / 2,25		10,00 / 2,21	
Heating capacity / COP (A -7 °C, W 35 °C)	kW / COP	9,00 / 2,88		10,10 / 2,74		11,60 / 2,57	
Heating capacity / COP (A -7 °C, W 55 °C)	kW / COP	8,10 / 2,07		8,40 / 1,97		9,10 / 1,85	
Cooling capacity / EER (A 35 °C, W 7 °C)	kW / EER	8,80 / 3,11		10,70 / 2,68		13,40 / 2,64	
Cooling capacity / EER (A 35 °C, W 18 °C)	kW / EER	8,80 / 4,63		10,70 / 3,92		15,50 / 3,60	
Heating average climate (W 35 °C / W 55 °C)	Seasonal energy efficiency	SCOP (η <sub>s</sub> %)	4,96 / 3,57 (195 / 140)	4,58 / 3,33 (180 / 130)	4,46 / 3,40 (176 / 133)		
	Energy class <sup>1)</sup>		A+++ / A++	A+++ / A++	A+++ / A++		
Heating warm climate (W 35 °C / W 55 °C)	Seasonal energy efficiency	SCOP (η <sub>s</sub> %)	6,47 / 4,34 (256 / 171)	6,47 / 4,34 (256 / 171)	6,20 / 4,30 (245 / 169)		
	Energy class <sup>1)</sup>		A+++ / A+++	A+++ / A+++	A+++ / A+++		
Heating cold climate (W 35 °C / W 55 °C)	Seasonal energy efficiency	SCOP (η <sub>s</sub> %)	4,31 / 3,26 (169 / 127)	4,31 / 3,26 (169 / 127)	4,28 / 3,10 (168 / 121)		
	Energy class <sup>1)</sup>		A++ / A++	A++ / A++	A++ / A+		
Indoor unit 3 kW electric heater		WH-SDC09K3E8		—		—	
Indoor unit 9 kW electric heater		WH-SDC09K9E8		WH-SDC12K9E8		WH-SDC16K9E8	
Sound pressure	Heat / Cool	dB(A)	33 / 33	33 / 33	33 / 33		
Dimension	H x W x D	mm	892 x 500 x 348	892 x 500 x 348	892 x 500 x 348		
Net weight 3 kW / 9 kW		kg	40 / 41	— / 41	— / 41		
Water pipe connector		Inch	R 1¼	R 1¼	R 1¼		
A class pump	Number of speeds		Variable speed	Variable speed	Variable speed		
	Input power	W	145	145	145		
Heating water flow (ΔT=5 K, 35 °C)		L/min	25,8	34,4	45,9		
Outdoor unit		WH-UDZ09KE8		WH-UDZ12KE8		WH-UDZ16KE8	
Sound power <sup>2)</sup>	Heat	dB(A)	65	65	65		
Dimension	H x W x D	mm	1340 x 900 x 320	1340 x 900 x 320	1340 x 900 x 320		
Net weight		kg	90	90	103		
Refrigerant (R32) / CO <sub>2</sub> Eq.		kg / T	1,60 / 1,080	1,60 / 1,080	1,83 / 1,235		
Piping diameter	Liquid / Gas	Inch (mm)	1/4 (6,35) / 1/2 (12,70)	1/4 (6,35) / 1/2 (12,70)	1/4 (6,35) / 1/2 (12,70)		
Pipe length range		m	3 - 30	3 - 30	3 - 30		
Elevation difference (in / out)		m	20	20	20		
Pre-charged pipe length		m	10	10	10		
Additional gas amount		g/m	30	30	30		
Operating range - outdoor ambient	Heat	°C	-25 ~ +35	-25 ~ +35	-25 ~ +35		
	Cool	°C	+10 ~ +43	+10 ~ +43	+10 ~ +43		
Water outlet <sup>3)</sup>	Heat / Cool	°C	20 ~ 60 / 5 ~ 20	20 ~ 60 / 5 ~ 20	20 ~ 60 / 5 ~ 20		
Electrical information		3 kW heater		9 kW heater		9 kW heater	
Electric backup heater		kW	3,00	9,00	9,00	9,00	
Recommended fuse <sup>4)</sup>		A	20 / 15 / 16	20 / 20	20 / 20	20 / 20	
Recommended minimum cable size, supply 1 / 2 <sup>4)</sup>		mm <sup>2</sup>	5x1,5 / 3x1,5	5x1,5 / 5x1,5	5x1,5 / 5x1,5	5x2,5 / 5x1,5	

1) Scale from A+++ to D. 2) Sound power level in accordance to EN 12102 under conditions of the EN14825. 3) Operation range down to -25 °C in heating with 3-40 m pipe length range, operation range down to -15 °C in heating with 3-50 m pipe length range. 4) Check local regulations. \* EER and COP calculation is based in accordance to EN 14511. \*\* This product is designed to comply with the European drinking water standard (EU) 2020/2184. The lifespan of the product is not guaranteed in the case of the use of groundwater, such as spring water or well water, the use of tap water when salt or other impurities are contained, nor in areas of acidic water quality. Maintenance and warranty costs related to these cases are the customer's responsibility.

Accessories	
<b>CZ-RTW1</b>	Optional remote controller for 2 zone control. K and L Series
<b>PAW-TD20C1E5-1</b>	Tank 200 L - Stainless steel
<b>PAW-TD30C1E5-1</b>	Tank 300 L - Stainless steel
<b>PAW-TA20C1E5STD</b>	Tank 200 L - Enamelled
<b>PAW-TA30C1E5STD</b>	Tank 300 L - Enamelled
<b>PAW-3WYVLV-HW</b>	3 way valve for DHW tanks
<b>CZ-NV2</b>	3 way valve kit to fit inside the hydrokit. K and L Series

Accessories	
<b>PAW-BTANK50L-2</b>	Buffer tank 50 L
<b>CZ-TAW1C</b>	Optional Wi-Fi or WLAN adapter for smart control via Panasonic Comfort Cloud and/or remote maintenance via Aquarea Service Cloud
<b>CZ-TAW1-CBL</b>	10 m extension cable for CZ-TAW1C
<b>CZ-NS5P</b>	PCB for advanced functions
<b>PAW-A2W-RTWIRED</b>	Room thermostat
<b>PAW-A2W-RTWIREDLESS</b>	Wireless LCD room thermostat



INTERNET CONTROL: Optional.

## Aquarea K Series

Aquarea K Series gives you even more.

Highly efficient Panasonic solutions can help to significantly reduce the energy consumption of the house, at the same time a high level of comfort and good indoor air quality are kept.



### Ventilation unit on top for a low-energy house

Heat recovery ventilation units are ideal for homes, for these owners who are looking for high performance and maximum comfort.

Combine the Residential ventilation unit with Panasonic Aquarea for an space saving and highly efficient solution for heating, cooling, ventilation and DHW.

### Aquarea + PV panels

Aquarea Heat Pumps can synchronise with PV panels, using the optional PCB CZ-NS5P. Thanks to this feature, demand of heating, cooling and domestic hot water production is adapted to the PV panel production.

### Smart Grid Ready

Aquarea K Series heat pumps in combination with the optional PCB CZ-NS5P hold the SG Ready function, allowing the heat pump to be connected in an intelligent grid control.

**Remote controller designed in harmony with the whole system, with optimised user interface and improved features.**

#### Smart bivalency.

Cost effective bivalent mode with power tariff logic.

#### Optimised user interface.

Each touch point designed in harmony, with optimised user interface across the range.

#### Dual controller system.

A dual controller system, for independent control of two zones, within the home.



**Aquarea T-CAP All in One 185 L K Series. Single phase / Three phase · R32**

**Energy efficiency:** A+++ in heating at 35 °C and A+ in DHW / "A" water pump with variable speed / Stainless steel DHW tank with U-Vacua™ insulation panel / Built-in flow meter.

**Flexibility:** 599 x 602 footprint / Built-in magnetic water filter.

**Comfort:** Constant capacity down to -20 °C / Operating range down to -28 °C / 60 °C hot water even at -10 °C outside temperature.

**Control:** Optimised user interface and improved features (2 zone control, bivalent control).

**Connectivity:** Optional Aquarea Smart and Service Cloud and integration into BMS projects.



Kit	Single phase (power to indoor)				Three phase (power to indoor)		
	KIT-AXC09K6E5	KIT-AXC12K6E5	KIT-AXC09K9E8	KIT-AXC12K9E8	KIT-AXC16K9E8		
Heating capacity / COP (A +7 °C, W 35 °C)	kW / COP	9,00/5,03	12,10/4,84	9,00/5,03	12,10/4,84	16,00/4,38	
Heating capacity / COP (A +7 °C, W 55 °C)	kW / COP	9,00/3,07	12,10/3,04	9,00/3,07	12,10/3,04	16,00/2,72	
Heating capacity / COP (A +2 °C, W 35 °C)	kW / COP	9,00/3,69	12,00/3,44	9,00/3,69	12,00/3,44	16,00/3,10	
Heating capacity / COP (A +2 °C, W 55 °C)	kW / COP	9,00/2,31	12,00/2,29	9,00/2,31	12,00/2,29	16,00/2,07	
Heating capacity / COP (A -7 °C, W 35 °C)	kW / COP	9,00/3,00	12,00/2,72	9,00/3,00	12,00/2,72	16,00/2,39	
Heating capacity / COP (A -7 °C, W 55 °C)	kW / COP	9,00/2,10	12,00/2,29	9,00/2,10	12,00/2,29	16,00/1,71	
Cooling capacity / EER (A 35 °C, W 7 °C)	kW / EER	8,80/3,11	10,70/2,68	8,80/3,11	10,70/2,68	13,40/2,64	
Cooling capacity / EER (A 35 °C, W 18 °C)	kW / EER	8,80/4,63	10,70/3,92	8,80/4,63	10,70/3,92	15,50/3,60	
Heating average climate (W 35 °C / W 55 °C)	Seasonal energy efficiency	SCOP (η <sub>s</sub> %)	4,96/3,57(195/140)	4,96/3,57(195/140)	4,96/3,57(195/140)	4,58/3,46(180/135)	4,46/3,31(176/129)
	Energy class <sup>1)</sup>	A+++ to D	A+++/A++	A+++/A++	A+++/A++	A+++/A++	A+++/A++
Heating warm climate (W 35 °C / W 55 °C)	Seasonal energy efficiency	SCOP (η <sub>s</sub> %)	6,47/4,34(256/171)	6,47/4,34(256/171)	6,47/4,34(256/171)	6,47/4,34(256/171)	5,88/4,09(232/160)
	Energy class <sup>1)</sup>	A+++ to D	A+++/A+++	A+++/A+++	A+++/A+++	A+++/A+++	A+++/A+++
Heating cold climate (W 35 °C / W 55 °C)	Seasonal energy efficiency	SCOP (η <sub>s</sub> %)	4,31/3,26(169/127)	4,31/3,26(169/127)	4,31/3,26(169/127)	4,31/3,26(169/127)	3,83/3,20(150/125)
	Energy class <sup>1)</sup>	A+++ to D	A++/A++	A++/A++	A++/A++	A++/A++	A++/A++
<b>Indoor unit</b>			<b>WH-ADC0912K6E5</b>	<b>WH-ADC0912K6E5</b>	<b>WH-ADC0912K9E8</b>	<b>WH-ADC0912K9E8</b>	<b>WH-ADC16K9E8</b>
Sound pressure	Heat / Cool	dB(A)	33/33	33/33	33/33	33/33	33/33
Dimension	H x W x D	mm	1642 x 599 x 602	1642 x 599 x 602	1642 x 599 x 602	1642 x 599 x 602	1642 x 599 x 602
Net weight		kg	101	101	102	102	103
Water pipe connector		Inch	R 1½	R 1½	R 1½	R 1½	R 1½
A class pump	Number of speeds		Variable speed	Variable speed	Variable speed	Variable speed	Variable speed
	Input power	W	145	145	145	145	173
Heating water flow (ΔT=5 K, 35 °C)		L/min	25,8	34,4	25,8	34,4	45,9
Water volume		L	185	185	185	185	185
Maximum DHW temperature		°C	65	65	65	65	65
Material inside tank			Stainless steel	Stainless steel	Stainless steel	Stainless steel	Stainless steel
Tapping profile according EN16147			L	L	L	L	L
DHW tank ERP efficiency average / warm / cold <sup>2)</sup>		A+ to F	A/A+/A	A/A+/A	A/A+/A	A/A+/A	A/A+/A
DHW tank ERP average climate η / COPdHW		η <sub>wh</sub> % / COPdHW	112/2,80	112/2,80	112/2,80	112/2,80	107/2,68
DHW tank ERP warm climate η / COPdHW		η <sub>wh</sub> % / COPdHW	132/3,30	132/3,30	132/3,30	132/3,30	128/3,20
DHW tank ERP cold climate η / COPdHW		η <sub>wh</sub> % / COPdHW	88/2,20	88/2,20	88/2,20	88/2,20	84/2,10
<b>Outdoor unit</b>			<b>WH-UXZ09KE5</b>	<b>WH-UXZ12KE5</b>	<b>WH-UXZ09KE8</b>	<b>WH-UXZ12KE8</b>	<b>WH-UXZ16KE8</b>
Sound power <sup>3)</sup>	Heat	dB(A)	65	65	65	65	65
Dimension / Net weight	H x W x D	mm / kg	1340 x 900 x 320/88	1340 x 900 x 320/88	1340 x 900 x 320/90	1340 x 900 x 320/90	1340 x 900 x 320/103
Refrigerant (R32) / CO <sub>2</sub> Eq.		kg / T	1,60/1,080	1,60/1,080	1,60/1,080	1,60/1,080	1,83/1,235
Piping diameter	Liquid / Gas	Inch (mm)	1/4(6,35)/1/2(12,70)	1/4(6,35)/1/2(12,70)	1/4(6,35)/1/2(12,70)	1/4(6,35)/1/2(12,70)	1/4(6,35)/1/2(12,70)
Pipe length range / Elevation difference (in / out)		m / m	3-30/20	3-30/20	3-30/20	3-30/20	3-30/20
Pre-charged pipe length / Additional gas amount		m / g/m	10/30	10/30	10/30	10/30	10/30
Operating range - outdoor ambient	Heat	°C	-28 ~ +35	-28 ~ +35	-28 ~ +35	-28 ~ +35	-28 ~ +35
	Cool	°C	+10 ~ +43	+10 ~ +43	+10 ~ +43	+10 ~ +43	+10 ~ +43
Water outlet <sup>4)</sup>	Heat / Cool	°C	20 ~ 60/5 ~ 20	20 ~ 60/5 ~ 20	20 ~ 60/5 ~ 20	20 ~ 60/5 ~ 20	20 ~ 60/5 ~ 20
<b>Electrical information</b>			<b>WH-ADC0912K6E5</b>	<b>WH-ADC0912K6E5</b>	<b>WH-ADC0912K9E8</b>	<b>WH-ADC0912K9E8</b>	<b>WH-ADC16K9E8</b>
Electric backup heater		kW	6,00	6,00	9,00	9,00	9,00
Recommended fuse <sup>5)</sup>		A	30/30	30/30	20/20	20/20	20/20
Recommended minimum cable size, supply 1 / 2 <sup>5)</sup>		mm <sup>2</sup>	3x4,0/3x4,0	3x4,0/3x4,0	5x1,5/5x1,5	5x1,5/5x1,5	5x2,5/5x1,5

1) Scale from A+++ to D. 2) Scale from A+ to F. 3) Sound power level in accordance to EN 12102 under conditions of the EN14825. 4) Between outdoor ambient -10 °C and -15 °C, the water outlet temperature gradually decreases from 60 °C to 55 °C. 5) Check local regulations. \* EER and COP calculation is based in accordance to EN 14511. \*\* This product is designed to comply with the European drinking water standard (EU) 2020/2184. The lifespan of the product is not guaranteed in the case of the use of groundwater, such as spring water or well water, the use of tap water when salt or other impurities are contained, nor in areas of acidic water quality. Maintenance and warranty costs related to these cases are the customer's responsibility.

Accessories	
<b>CZ-RTW1</b>	Optional remote controller for 2 zone control. K and L Series
<b>CZ-TAW1C</b>	Optional Wi-Fi or WLAN adapter for smart control via Panasonic Comfort Cloud and/or remote maintenance via Aquarea Service Cloud

Accessories	
<b>CZ-TAW1-CBL</b>	10 m extension cable for CZ-TAW1C
<b>CZ-NS5P</b>	PCB for advanced functions
<b>PAW-A2W-RTWIRED</b>	Room thermostat
<b>PAW-A2W-RTWIREDLESS</b>	Wireless LCD room thermostat



INTERNET CONTROL: Optional.

## Aquarea T-CAP All in One 185 L K Series. Single phase / Three phase with Electrical Anode · R32

**Energy efficiency:** A+++ in heating at 35 °C and A+ in DHW / "A" water pump with variable speed / Stainless steel DHW tank with U-Vacua™ insulation panel / Built-in flow meter.

**Flexibility:** 599 x 602 footprint / Built-in magnetic water filter.

**Comfort:** Constant capacity down to -20 °C / Operating range down to -28 °C / 60 °C hot water even at -10 °C outside temperature.

**Control:** Optimised user interface and improved features (2 zone control, bivalent control).

**Connectivity:** Optional Aquarea Smart and Service Cloud and integration into BMS projects.



Kit	Single phase (power to indoor)			Three phase (power to indoor)			
	KIT-AXC09K6E5AN	KIT-AXC12K6E5AN	KIT-AXC09K9E8AN	KIT-AXC12K9E8AN	KIT-AXC16K9E8AN		
Heating capacity / COP (A +7 °C, W 35 °C)	kW / COP		9,00/5,03	12,10/4,84	9,00/5,03	12,10/4,84	16,00/4,38
Heating capacity / COP (A +7 °C, W 55 °C)	kW / COP		9,00/3,07	12,10/3,04	9,00/3,07	12,10/3,04	16,00/2,72
Heating capacity / COP (A +2 °C, W 35 °C)	kW / COP		9,00/3,69	12,00/3,44	9,00/3,69	12,00/3,44	16,00/3,10
Heating capacity / COP (A +2 °C, W 55 °C)	kW / COP		9,00/2,31	12,00/2,29	9,00/2,31	12,00/2,29	16,00/2,07
Heating capacity / COP (A -7 °C, W 35 °C)	kW / COP		9,00/3,00	12,00/2,72	9,00/3,00	12,00/2,72	16,00/2,39
Heating capacity / COP (A -7 °C, W 55 °C)	kW / COP		9,00/2,10	12,00/2,29	9,00/2,10	12,00/2,29	16,00/1,71
Cooling capacity / EER (A 35 °C, W 7 °C)	kW / EER		8,80/3,11	10,70/2,68	8,80/3,11	10,70/2,68	13,40/2,64
Cooling capacity / EER (A 35 °C, W 18 °C)	kW / EER		8,80/4,63	10,70/3,92	8,80/4,63	10,70/3,92	15,50/3,60
Heating average climate (W 35 °C / W 55 °C)	Seasonal energy efficiency	SCOP (η <sub>s</sub> %)	4,96/3,57(195/140)	4,96/3,57(195/140)	4,96/3,57(195/140)	4,58/3,46(180/135)	4,46/3,31(176/129)
	Energy class <sup>1)</sup>		A+++ to D	A+++/A++	A+++/A++	A+++/A++	A+++/A++
Heating warm climate (W 35 °C / W 55 °C)	Seasonal energy efficiency	SCOP (η <sub>s</sub> %)	6,47/4,34(256/171)	6,47/4,34(256/171)	6,47/4,34(256/171)	6,47/4,34(256/171)	5,88/4,09(232/160)
	Energy class <sup>1)</sup>		A+++ to D	A+++/A+++	A+++/A+++	A+++/A+++	A+++/A+++
Heating cold climate (W 35 °C / W 55 °C)	Seasonal energy efficiency	SCOP (η <sub>s</sub> %)	4,31/3,26(169/127)	4,31/3,26(169/127)	4,31/3,26(169/127)	4,31/3,26(169/127)	3,83/3,20(150/125)
	Energy class <sup>1)</sup>		A+++ to D	A++/A++	A++/A++	A++/A++	A++/A++
<b>Indoor unit</b>	<b>WH-</b>	<b>ADC0912K6E5AN</b>	<b>ADC0912K6E5AN</b>	<b>ADC0912K9E8AN</b>	<b>ADC0912K9E8AN</b>	<b>ADC16K9E8AN</b>	
Sound pressure	Heat / Cool	dB(A)	33/33	33/33	33/33	33/33	33/33
Dimension	H x W x D	mm	1642 x 599 x 602	1642 x 599 x 602	1642 x 599 x 602	1642 x 599 x 602	1642 x 599 x 602
Net weight		kg	101	101	102	102	103
Water pipe connector		Inch	R 1½	R 1½	R 1½	R 1½	R 1½
A class pump	Number of speeds		Variable speed	Variable speed	Variable speed	Variable speed	Variable speed
	Input power	W	145	145	145	145	173
Heating water flow (ΔT=5 K, 35 °C)		L/min	25,8	34,4	25,8	34,4	45,9
Water volume		L	185	185	185	185	185
Maximum DHW temperature		°C	65	65	65	65	65
Material inside tank			Stainless steel	Stainless steel	Stainless steel	Stainless steel	Stainless steel
Tapping profile according EN16147			L	L	L	L	L
DHW tank ERP efficiency average / warm / cold <sup>2)</sup>		A+ to F	A/A+/A	A/A+/A	A/A+/A	A/A+/A	A/A+/A
DHW tank ERP average climate η / COP <sub>dHW</sub>		η <sub>wh</sub> % / COP <sub>dHW</sub>	112/2,80	112/2,80	112/2,80	112/2,80	107/2,68
DHW tank ERP warm climate η / COP <sub>dHW</sub>		η <sub>wh</sub> % / COP <sub>dHW</sub>	132/3,30	132/3,30	132/3,30	132/3,30	128/3,20
DHW tank ERP cold climate η / COP <sub>dHW</sub>		η <sub>wh</sub> % / COP <sub>dHW</sub>	88/2,20	88/2,20	88/2,20	88/2,20	84/2,10
<b>Outdoor unit</b>	<b>WH-UXZ09KE5</b>	<b>WH-UXZ12KE5</b>	<b>WH-UXZ09KE8</b>	<b>WH-UXZ12KE8</b>	<b>WH-UXZ16KE8</b>		
Sound power <sup>3)</sup>	Heat	dB(A)	65	65	65	65	65
Dimension / Net weight	H x W x D	mm / kg	1340 x 900 x 320/88	1340 x 900 x 320/88	1340 x 900 x 320/90	1340 x 900 x 320/90	1340 x 900 x 320/103
Refrigerant (R32) / CO <sub>2</sub> Eq.		kg / T	1,60/1,080	1,60/1,080	1,60/1,080	1,60/1,080	1,83/1,235
Piping diameter	Liquid / Gas	Inch (mm)	1/4(6,35)/1/2(12,70)	1/4(6,35)/1/2(12,70)	1/4(6,35)/1/2(12,70)	1/4(6,35)/1/2(12,70)	1/4(6,35)/1/2(12,70)
Pipe length range / Elevation difference (in / out)		m / m	3~30/20	3~30/20	3~30/20	3~30/20	3~30/20
Pre-charged pipe length / Additional gas amount		m / g/m	10/30	10/30	10/30	10/30	10/30
Operating range - outdoor ambient	Heat	°C	-28~+35	-28~+35	-28~+35	-28~+35	-28~+35
	Cool	°C	+10~+43	+10~+43	+10~+43	+10~+43	+10~+43
Water outlet	Heat / Cool	°C	20~60/5~20	20~60/5~20	20~60/5~20	20~60/5~20	20~60/5~20
<b>Electrical information</b>	<b>WH-</b>	<b>ADC0912K6E5AN</b>	<b>ADC0912K6E5AN</b>	<b>ADC0912K9E8AN</b>	<b>ADC0912K9E8AN</b>	<b>ADC16K9E8AN</b>	
Electric backup heater		kW	6,00	6,00	9,00	9,00	9,00
Recommended fuse <sup>4)</sup>		A	30/30	30/30	20/20	20/20	20/20
Recommended minimum cable size, supply 1 / 2 <sup>4)</sup>		mm <sup>2</sup>	3x4,0/3x4,0	3x4,0/3x4,0	5x1,5/5x1,5	5x1,5/5x1,5	5x2,5/5x1,5

1) Scale from A+++ to D. 2) Scale from A+ to F. 3) Sound power level in accordance to EN 12102 under conditions of the EN14825. 4) Check local regulations. \* EER and COP calculation is based in accordance to EN 14511. \*\* This product is designed to comply with the European drinking water standard (EU) 2020/2184. The lifespan of the product is not guaranteed in the case of the use of groundwater, such as spring water or well water, the use of tap water when salt or other impurities are contained, nor in areas of acidic water quality. Maintenance and warranty costs related to these cases are the customer's responsibility.

Accessories	
<b>CZ-RTW1</b>	Optional remote controller for 2 zone control. K and L Series
<b>CZ-TAW1C</b>	Optional Wi-Fi or WLAN adapter for smart control via Panasonic Comfort Cloud and/or remote maintenance via Aquarea Service Cloud

Accessories	
<b>CZ-TAW1-CBL</b>	10 m extension cable for CZ-TAW1C
<b>CZ-NS5P</b>	PCB for advanced functions
<b>PAW-A2W-RTWIRED</b>	Room thermostat
<b>PAW-A2W-RTWIRELESS</b>	Wireless LCD room thermostat



INTERNET CONTROL: Optional.

**Aquarea T-CAP All in One 260 L K Series. Single phase / Three phase · R32**

**Energy efficiency:** A+++ in heating at 35 °C and A+ in DHW / "A" water pump with variable speed / Stainless steel DHW tank with U-Vacua™ insulation panel / Built-in flow meter.  
**Flexibility:** 260 L DHW tank / 599 x 602 footprint / Built-in magnetic water filter.  
**Comfort:** Constant capacity down to -20 °C / Operating range down to -28 °C / 60 °C hot water even at -10 °C outside temperature.  
**Control:** Optimised user interface and improved features (2 zone control, bivalent control).  
**Connectivity:** Optional Aquarea Smart and Service Cloud and integration into BMS projects.



Kit	Single phase (power to indoor)					Three phase (power to indoor)				
		KIT-AXC09K6E53	KIT-AXC12K6E53	KIT-AXC09K9E83	KIT-AXC12K9E83	KIT-AXC16K9E83				
Heating capacity / COP (A +7 °C, W 35 °C)	kW / COP	9,00/5,03	12,10/4,84	9,00/5,03	12,10/4,84	16,00/4,38				
Heating capacity / COP (A +7 °C, W 55 °C)	kW / COP	9,00/3,07	12,10/3,04	9,00/3,07	12,10/3,04	16,00/2,72				
Heating capacity / COP (A +2 °C, W 35 °C)	kW / COP	9,00/3,69	12,00/3,44	9,00/3,69	12,00/3,44	16,00/3,10				
Heating capacity / COP (A +2 °C, W 55 °C)	kW / COP	9,00/2,31	12,00/2,29	9,00/2,31	12,00/2,29	16,00/2,07				
Heating capacity / COP (A -7 °C, W 35 °C)	kW / COP	9,00/3,00	12,00/2,72	9,00/3,00	12,00/2,72	16,00/2,39				
Heating capacity / COP (A -7 °C, W 55 °C)	kW / COP	9,00/2,10	12,00/2,29	9,00/2,10	12,00/2,29	16,00/1,71				
Cooling capacity / EER (A 35 °C, W 7 °C)	kW / EER	8,80/3,11	10,70/2,68	8,80/3,11	10,70/2,68	13,40/2,64				
Cooling capacity / EER (A 35 °C, W 18 °C)	kW / EER	8,80/4,63	10,70/3,92	8,80/4,63	10,70/3,92	15,50/3,60				
Heating average climate (W 35 °C / W 55 °C)	Seasonal energy efficiency	SCOP (η <sub>s</sub> %)	4,96/3,57(195/140)	4,96/3,57(195/140)	4,96/3,57(195/140)	4,58/3,46(180/135)	4,46/3,31(176/129)			
	Energy class <sup>1)</sup>	A+++ to D	A+++/A++	A+++/A++	A+++/A++	A+++/A++	A+++/A++			
Heating warm climate (W 35 °C / W 55 °C)	Seasonal energy efficiency	SCOP (η <sub>s</sub> %)	6,47/4,34(256/171)	6,47/4,34(256/171)	6,47/4,34(256/171)	6,47/4,34(256/171)	5,88/4,09(232/160)			
	Energy class <sup>1)</sup>	A+++ to D	A+++/A+++	A+++/A+++	A+++/A+++	A+++/A+++	A+++/A+++			
Heating cold climate (W 35 °C / W 55 °C)	Seasonal energy efficiency	SCOP (η <sub>s</sub> %)	4,31/3,26(169/127)	4,31/3,26(169/127)	4,31/3,26(169/127)	4,31/3,26(169/127)	3,83/3,20(150/125)			
	Energy class <sup>1)</sup>	A+++ to D	A++/A++	A++/A++	A++/A++	A++/A++	A++/A++			
<b>Indoor unit</b>			<b>WH-ADC0912K6E53</b>	<b>WH-ADC0912K6E53</b>	<b>WH-ADC0912K9E83</b>	<b>WH-ADC0912K9E83</b>	<b>WH-ADC16K9E83</b>			
Sound pressure	Heat / Cool	dB(A)	33/33	33/33	33/33	33/33	33/33			
Dimension	H x W x D	mm	2036 x 599 x 602	2036 x 599 x 602	2036 x 599 x 602	2036 x 599 x 602	2036 x 599 x 602			
Net weight		kg	119	119	119	119	120			
Water pipe connector		Inch	R 1½	R 1½	R 1½	R 1½	R 1½			
A class pump	Number of speeds		Variable speed	Variable speed	Variable speed	Variable speed	Variable speed			
	Input power	W	145	145	145	145	145			
Heating water flow (ΔT=5 K, 35 °C)		L/min	25,8	34,4	25,8	34,4	45,9			
Water volume		L	260	260	260	260	260			
Maximum DHW temperature		°C	65	65	65	65	65			
Material inside tank			Stainless steel	Stainless steel	Stainless steel	Stainless steel	Stainless steel			
Tapping profile according EN16147			XL	XL	XL	XL	XL			
DHW tank ERP efficiency average / warm / cold <sup>2)</sup>		A+ to F	A+/A+/A	A+/A+/A	A+/A+/A	A+/A+/A	A+/A+/A			
DHW tank ERP average climate η / COP <sub>DHW</sub>	η <sub>wh</sub> % / COP <sub>DHW</sub>		123/3,08	123/3,08	123/3,08	123/3,08	98/2,45			
DHW tank ERP warm climate η / COP <sub>DHW</sub>	η <sub>wh</sub> % / COP <sub>DHW</sub>		134/3,35	134/3,35	134/3,35	134/3,35	123/3,08			
DHW tank ERP cold climate η / COP <sub>DHW</sub>	η <sub>wh</sub> % / COP <sub>DHW</sub>		94/2,35	94/2,35	94/2,35	94/2,35	80/2,00			
<b>Outdoor unit</b>			<b>WH-UXZ09KE5</b>	<b>WH-UXZ12KE5</b>	<b>WH-UXZ09KE8</b>	<b>WH-UXZ12KE8</b>	<b>WH-UXZ16KE8</b>			
Sound power <sup>3)</sup>	Heat	dB(A)	65	65	65	65	65			
Dimension / Net weight	H x W x D	mm / kg	1340 x 900 x 320 / 88	1340 x 900 x 320 / 88	1340 x 900 x 320 / 90	1340 x 900 x 320 / 90	1340 x 900 x 320 / 103			
Refrigerant (R32) / CO <sub>2</sub> Eq.		kg / T	1,60/1,080	1,60/1,080	1,60/1,080	1,60/1,080	1,83/1,235			
Piping diameter	Liquid / Gas	Inch (mm)	1/4(6,35)/1/2(12,70)	1/4(6,35)/1/2(12,70)	1/4(6,35)/1/2(12,70)	1/4(6,35)/1/2(12,70)	1/4(6,35)/1/2(12,70)			
Pipe length range / Elevation difference (in / out)		m / m	3-30/20	3-30/20	3-30/20	3-30/20	3-30/20			
Pre-charged pipe length / Additional gas amount		m / g/m	10/30	10/30	10/30	10/30	10/30			
Operating range - outdoor ambient	Heat	°C	-28 ~ +35	-28 ~ +35	-28 ~ +35	-28 ~ +35	-28 ~ +35			
	Cool	°C	+10 ~ +43	+10 ~ +43	+10 ~ +43	+10 ~ +43	+10 ~ +43			
Water outlet <sup>4)</sup>	Heat / Cool	°C	20 ~ 60/5 ~ 20	20 ~ 60/5 ~ 20	20 ~ 60/5 ~ 20	20 ~ 60/5 ~ 20	20 ~ 60/5 ~ 20			
<b>Electrical information</b>			<b>WH-ADC0912K6E53</b>	<b>WH-ADC0912K6E53</b>	<b>WH-ADC0912K9E83</b>	<b>WH-ADC0912K9E83</b>	<b>WH-ADC16K9E83</b>			
Electric backup heater		kW	6,00	6,00	9,00	9,00	9,00			
Recommended fuse <sup>5)</sup>		A	30/30	30/30	20/20	20/20	20/20			
Recommended minimum cable size, supply 1 / 2 <sup>5)</sup>		mm <sup>2</sup>	3x4,0/3x4,0	3x4,0/3x4,0	5x1,5/5x1,5	5x1,5/5x1,5	5x2,5/5x1,5			

1) Scale from A+++ to D. 2) Scale from A+ to F. 3) Sound power level in accordance to EN 12102 under conditions of the EN14825. 4) Between outdoor ambient -10 °C and -15 °C, the water outlet temperature gradually decreases from 60 °C to 55 °C. 5) Check local regulations. \* EER and COP calculation is based in accordance to EN 14511. \*\* This product is designed to comply with the European drinking water standard (EU) 2020/2184. The lifespan of the product is not guaranteed in the case of the use of groundwater, such as spring water or well water, the use of tap water when salt or other impurities are contained, nor in areas of acidic water quality. Maintenance and warranty costs related to these cases are the customer's responsibility.

Accessories	
<b>CZ-RTW1</b>	Optional remote controller for 2 zone control. K and L Series
<b>CZ-TAW1C</b>	Optional Wi-Fi or WLAN adapter for smart control via Panasonic Comfort Cloud and/or remote maintenance via Aquarea Service Cloud

Accessories	
<b>CZ-TAW1-CBL</b>	10 m extension cable for CZ-TAW1C
<b>CZ-NS5P</b>	PCB for advanced functions
<b>PAW-A2W-RTWIRED</b>	Room thermostat
<b>PAW-A2W-RTWIREDLESS</b>	Wireless LCD room thermostat



INTERNET CONTROL: Optional.

## Aquarea T-CAP All in One 260 L K Series. Single phase / Three phase with Electrical Anode · R32

**Energy efficiency:** A+++ in heating at 35 °C and A+ in DHW / "A" water pump with variable speed / Stainless steel DHW tank with U-Vacua™ insulation panel / Built-in flow meter.

**Flexibility:** 260 L DHW tank / 599 x 602 footprint / Built-in magnetic water filter / Installation in harsh water conditions.

**Comfort:** Constant capacity down to -20 °C / Operating range down to -28 °C / 60 °C hot water even at -10 °C outside temperature.

**Control:** Optimised user interface and improved features (2 zone control, bivalent control).

**Connectivity:** Optional Aquarea Smart and Service Cloud and integration into BMS projects.



Kit	Single phase (power to indoor)					Three phase (power to indoor)					
		KIT-AXC09K6E5AN3	KIT-AXC12K6E5AN3	KIT-AXC09K9E8AN3	KIT-AXC12K9E8AN3	KIT-AXC16K9E8AN3					
Heating capacity / COP (A +7 °C, W 35 °C)	kW / COP	9,00/5,03	12,10/4,84	9,00/5,03	12,10/4,84	16,00/4,38					
Heating capacity / COP (A +7 °C, W 55 °C)	kW / COP	9,00/3,07	12,10/3,04	9,00/3,07	12,10/3,04	16,00/2,72					
Heating capacity / COP (A +2 °C, W 35 °C)	kW / COP	9,00/3,69	12,00/3,44	9,00/3,69	12,00/3,44	16,00/3,10					
Heating capacity / COP (A +2 °C, W 55 °C)	kW / COP	9,00/2,31	12,00/2,29	9,00/2,31	12,00/2,29	16,00/2,07					
Heating capacity / COP (A -7 °C, W 35 °C)	kW / COP	9,00/3,00	12,00/2,72	9,00/3,00	12,00/2,72	16,00/2,39					
Heating capacity / COP (A -7 °C, W 55 °C)	kW / COP	9,00/2,10	12,00/2,29	9,00/2,10	12,00/2,29	16,00/1,71					
Cooling capacity / EER (A 35 °C, W 7 °C)	kW / EER	8,80/3,11	10,70/2,68	8,80/3,11	10,70/2,68	13,40/2,64					
Cooling capacity / EER (A 35 °C, W 18 °C)	kW / EER	8,80/4,63	10,70/3,92	8,80/4,63	10,70/3,92	15,50/3,60					
Heating average climate (W 35 °C / W 55 °C)	Seasonal energy efficiency	SCOP (η <sub>s</sub> , %)	4,96/3,57(195/140)	4,96/3,57(195/140)	4,96/3,57(195/140)	4,58/3,46(180/135)	4,46/3,31(176/129)				
	Energy class <sup>1)</sup>		A+++ to D	A+++/A++	A+++/A++	A+++/A++	A+++/A++	A+++/A++			
Heating warm climate (W 35 °C / W 55 °C)	Seasonal energy efficiency	SCOP (η <sub>s</sub> , %)	6,47/4,34(256/171)	6,47/4,34(256/171)	6,47/4,34(256/171)	6,47/4,34(256/171)	5,88/4,09(232/160)				
	Energy class <sup>1)</sup>		A+++ to D	A+++/A+++	A+++/A+++	A+++/A+++	A+++/A+++	A+++/A+++			
Heating cold climate (W 35 °C / W 55 °C)	Seasonal energy efficiency	SCOP (η <sub>s</sub> , %)	4,31/3,26(169/127)	4,31/3,26(169/127)	4,31/3,26(169/127)	4,31/3,26(169/127)	3,83/3,20(150/125)				
	Energy class <sup>1)</sup>		A+++ to D	A++/A++	A++/A++	A++/A++	A++/A++	A++/A++			
<b>Indoor unit</b>		<b>WH-</b>	<b>ADC0912K6E5AN3</b>	<b>ADC0912K6E5AN3</b>	<b>ADC0912K9E8AN3</b>	<b>ADC0912K9E8AN3</b>	<b>ADC16K9E8AN3</b>				
Sound pressure	Heat / Cool	dB(A)	33/33	33/33	33/33	33/33	33/33				
Dimension	H x W x D	mm	2036 x 599 x 602	2036 x 599 x 602	2036 x 599 x 602	2036 x 599 x 602	2036 x 599 x 602				
Net weight		kg	119	119	119	119	120				
Water pipe connector		Inch	R 1½	R 1½	R 1½	R 1½	R 1½				
A class pump	Number of speeds		Variable speed	Variable speed	Variable speed	Variable speed	Variable speed				
	Input power	W	145	145	145	145	145				
Heating water flow (ΔT=5 K, 35 °C)		L/min	25,8	34,4	25,8	34,4	45,9				
Water volume		L	260	260	260	260	260				
Maximum DHW temperature		°C	65	65	65	65	65				
Material inside tank			Stainless steel	Stainless steel	Stainless steel	Stainless steel	Stainless steel				
Tapping profile according EN16147			XL	XL	XL	XL	XL				
DHW tank ERP efficiency average / warm / cold <sup>2)</sup>		A+ to F	A+ / A+ / A	A+ / A+ / A	A+ / A+ / A	A+ / A+ / A	A+ / A+ / A				
DHW tank ERP average climate η / COP <sub>DHW</sub>	η <sub>wh</sub> % / COP <sub>DHW</sub>		123/3,08	123/3,08	123/3,08	123/3,08	98/2,45				
DHW tank ERP warm climate η / COP <sub>DHW</sub>	η <sub>wh</sub> % / COP <sub>DHW</sub>		134/3,35	134/3,35	134/3,35	134/3,35	123/3,08				
DHW tank ERP cold climate η / COP <sub>DHW</sub>	η <sub>wh</sub> % / COP <sub>DHW</sub>		94/2,35	94/2,35	94/2,35	94/2,35	80/2,00				
<b>Outdoor unit</b>		<b>WH-UXX09KE5</b>	<b>WH-UXX12KE5</b>	<b>WH-UXX09KE8</b>	<b>WH-UXX12KE8</b>	<b>WH-UXX16KE8</b>					
Sound power <sup>3)</sup>	Heat	dB(A)	65	65	65	65	65				
Dimension / Net weight	H x W x D	mm / kg	1340 x 900 x 320/88	1340 x 900 x 320/88	1340 x 900 x 320/90	1340 x 900 x 320/90	1340 x 900 x 320/103				
Refrigerant (R32) / CO <sub>2</sub> Eq.		kg / T	1,60/1,080	1,60/1,080	1,60/1,080	1,60/1,080	1,83/1,235				
Piping diameter	Liquid / Gas	Inch (mm)	1/4(6,35)/1/2(12,70)	1/4(6,35)/1/2(12,70)	1/4(6,35)/1/2(12,70)	1/4(6,35)/1/2(12,70)	1/4(6,35)/1/2(12,70)				
Pipe length range / Elevation difference (in / out)		m / m	3~30/20	3~30/20	3~30/20	3~30/20	3~30/20				
Pre-charged pipe length / Additional gas amount		m / g/m	10/30	10/30	10/30	10/30	10/30				
Operating range - outdoor ambient	Heat	°C	-28~+35	-28~+35	-28~+35	-28~+35	-28~+35				
	Cool	°C	+10~+43	+10~+43	+10~+43	+10~+43	+10~+43				
Water outlet <sup>4)</sup>	Heat / Cool	°C	20~60/5~20	20~60/5~20	20~60/5~20	20~60/5~20	20~60/5~20				
<b>Electrical information</b>		<b>WH-</b>	<b>ADC0912K6E5AN3</b>	<b>ADC0912K6E5AN3</b>	<b>ADC0912K9E8AN3</b>	<b>ADC0912K9E8AN3</b>	<b>ADC16K9E8AN3</b>				
Electric backup heater		kW	6,00	6,00	9,00	9,00	9,00				
Recommended fuse <sup>5)</sup>		A	30/30	30/30	20/20	20/20	20/20				
Recommended minimum cable size, supply 1 / 2 <sup>5)</sup>		mm <sup>2</sup>	3x4,0/3x4,0	3x4,0/3x4,0	5x1,5/5x1,5	5x1,5/5x1,5	5x2,5/5x1,5				

1) Scale from A+++ to D. 2) Scale from A+ to F. 3) Sound power level in accordance to EN 12102 under conditions of the EN14825. 4) Between outdoor ambient -10 °C and -15 °C, the water outlet temperature gradually decreases from 60 °C to 55 °C. 5) Check local regulations. \* EER and COP calculation is based in accordance to EN 14511. \*\* This product is designed to comply with the European drinking water standard (EU) 2020/2184. The lifespan of the product is not guaranteed in the case of the use of groundwater, such as spring water or well water, the use of tap water when salt or other impurities are contained, nor in areas of acidic water quality. Maintenance and warranty costs related to these cases are the customer's responsibility.

Accessories	
<b>CZ-RTW1</b>	Optional remote controller for 2 zone control. K and L Series
<b>CZ-TAW1C</b>	Optional Wi-Fi or WLAN adapter for smart control via Panasonic Comfort Cloud and/or remote maintenance via Aquarea Service Cloud

Accessories	
<b>CZ-TAW1-CBL</b>	10 m extension cable for CZ-TAW1C
<b>CZ-NS5P</b>	PCB for advanced functions
<b>PAW-A2W-RTWIRED</b>	Room thermostat
<b>PAW-A2W-RTWIREDLESS</b>	Wireless LCD room thermostat



INTERNET CONTROL: Optional.



**Aquarea T-CAP Bi-bloc K Series. Single phase / Three phase · R32**

**Energy efficiency:** A+++ in heating at 35 °C and A+ in DHW / "A" water pump with variable speed / Built-in flow meter.

**Flexibility:** Built-in magnetic water filter.

**Comfort:** Constant capacity down to -20 °C / Operating range down to -28 °C / 60 °C hot water even at -10 °C outside temperature.

**Control:** Optimised user interface and improved features (2 zone control, bivalent control).

**Connectivity:** Optional Aquarea Smart and Service Cloud and integration into BMS projects.



		Single phase (power to indoor)			Three phase (power to indoor)			
		KIT-WXC09K3E5	—	KIT-WXC09K3E8	—	—	—	
		KIT-WXC09K6E5	KIT-WXC12K6E5	—	—	—	—	
		—	—	KIT-WXC09K9E8	KIT-WXC12K9E8	KIT-WXC16K9E8	—	
Heating capacity / COP (A +7 °C, W 35 °C)	kW / COP	9,00/5,03	12,10/4,84	9,00/5,03	12,10/4,84	16,00/4,38	—	
Heating capacity / COP (A +7 °C, W 55 °C)	kW / COP	9,00/3,07	12,10/3,04	9,00/3,07	12,10/3,04	16,00/2,72	—	
Heating capacity / COP (A +2 °C, W 35 °C)	kW / COP	9,00/3,69	12,00/3,44	9,00/3,69	12,00/3,44	16,00/3,10	—	
Heating capacity / COP (A +2 °C, W 55 °C)	kW / COP	9,00/2,31	12,00/2,29	9,00/2,31	12,00/2,29	16,00/2,07	—	
Heating capacity / COP (A -7 °C, W 35 °C)	kW / COP	9,00/3,00	12,00/2,72	9,00/3,00	12,00/2,72	16,00/2,39	—	
Heating capacity / COP (A -7 °C, W 55 °C)	kW / COP	9,00/2,10	12,00/2,29	9,00/2,10	12,00/2,29	16,00/1,71	—	
Cooling capacity / EER (A 35 °C, W 7 °C)	kW / EER	8,80/3,11	10,70/2,68	8,80/3,11	10,70/2,68	13,40/2,64	—	
Cooling capacity / EER (A 35 °C, W 18 °C)	kW / EER	8,80/4,63	10,70/3,92	8,80/4,63	10,70/3,92	15,50/3,60	—	
Heating average climate (W 35 °C / W 55 °C)	Seasonal energy efficiency	SCOP (η <sub>s</sub> %)	4,96/3,57(195/140)	4,96/3,57(195/140)	4,96/3,57(195/140)	4,58/3,46(180/135)	4,46/3,31(176/129)	
	Energy class <sup>1)</sup>		A+++ / A++	A+++ / A++	A+++ / A++	A+++ / A++	A+++ / A++	
Heating warm climate (W 35 °C / W 55 °C)	Seasonal energy efficiency	SCOP (η <sub>s</sub> %)	6,47/4,34(256/171)	6,47/4,34(256/171)	6,47/4,34(256/171)	6,47/4,34(256/171)	5,88/4,09(232/160)	
	Energy class <sup>1)</sup>		A+++ / A+++	A+++ / A+++	A+++ / A+++	A+++ / A+++	A+++ / A+++	
Heating cold climate (W 35 °C / W 55 °C)	Seasonal energy efficiency	SCOP (η <sub>s</sub> %)	4,31/3,26(169/127)	4,31/3,26(169/127)	4,31/3,26(169/127)	4,31/3,26(169/127)	3,83/3,20(150/125)	
	Energy class <sup>1)</sup>		A++ / A++	A++ / A++	A++ / A++	A++ / A++	A++ / A++	
<b>Indoor unit 3 kW electric heater</b>		<b>WH-SXC09K3E5</b>	—	<b>WH-SXC09K3E8</b>	—	—	—	
<b>Indoor unit 6 kW electric heater</b>		<b>WH-SXC09K6E5</b>	<b>WH-SXC12K6E5</b>	—	—	—	—	
<b>Indoor unit 9 kW electric heater</b>		—	—	<b>WH-SXC09K9E8</b>	<b>WH-SXC12K9E8</b>	<b>WH-SXC16K9E8</b>	—	
Sound pressure	Heat / Cool	dB(A)	33/33	33/33	33/33	33/33	33/33	
Dimension	H x W x D	mm	892 x 500 x 348	892 x 500 x 348	892 x 500 x 348	892 x 500 x 348	892 x 500 x 348	
Net weight 3 kW / 6 kW / 9 kW		kg	40/41 / —	—/41 / —	40 / —/41	— / —/41	— / —/42	
Water pipe connector		Inch	R 1½	R 1½	R 1½	R 1½	R 1½	
A class pump	Number of speeds		Variable speed	Variable speed	Variable speed	Variable speed	Variable speed	
	Input power	W	145	145	145	145	173	
Heating water flow (ΔT=5 K, 35 °C)		L/min	25,8	34,4	25,8	34,4	45,9	
<b>Outdoor unit</b>		<b>WH-UXZ09K5</b>	<b>WH-UXZ12K5</b>	<b>WH-UXZ09K8</b>	<b>WH-UXZ12K8</b>	<b>WH-UXZ16K8</b>	—	
Sound power <sup>2)</sup>	Heat	dB(A)	65	65	65	65	65	
Dimension	H x W x D	mm	1340 x 900 x 320	1340 x 900 x 320	1340 x 900 x 320	1340 x 900 x 320	1340 x 900 x 320	
Net weight		kg	88	88	90	90	103	
Refrigerant (R32) / CO <sub>2</sub> Eq.		kg / T	1,60/1,080	1,60/1,080	1,60/1,080	1,60/1,080	1,83/1,235	
Piping diameter	Liquid / Gas	Inch (mm)	1/4(6,35)/1/2(12,70)	1/4(6,35)/1/2(12,70)	1/4(6,35)/1/2(12,70)	1/4(6,35)/1/2(12,70)	1/4(6,35)/1/2(12,70)	
Pipe length range / Elevation difference (in / out)		m	3-30/20	3-30/20	3-30/20	3-30/20	3-30/20	
Pre-charged pipe length / Additional gas amount		m / g/m	10/30	10/30	10/30	10/30	10/30	
Operating range - outdoor ambient	Heat	°C	-28 ~ +35	-28 ~ +35	-28 ~ +35	-28 ~ +35	-28 ~ +35	
	Cool	°C	+10 ~ +43	+10 ~ +43	+10 ~ +43	+10 ~ +43	+10 ~ +43	
Water outlet <sup>3)</sup>	Heat / Cool	°C	20 ~ 60/5 ~ 20	20 ~ 60/5 ~ 20	20 ~ 60/5 ~ 20	20 ~ 60/5 ~ 20	20 ~ 60/5 ~ 20	
<b>Electrical information</b>		<b>Heater</b>	<b>3 kW</b>	<b>6 kW</b>	<b>6 kW</b>	<b>3 kW</b>	<b>9 kW</b>	<b>9 kW</b>
Electric backup heater		kW	3,00	6,00	6,00	3,00	9,00	9,00
Recommended fuse <sup>4)</sup>		A	30/15 or 16	30/30	30/30	20/15 or 16	20/20	20/20
Recommended minimum cable size, supply 1 / 2 <sup>4)</sup>		mm <sup>2</sup>	3x4,0/3x1,5	3x4,0/3x4,0	3x4,0/3x4,0	5x1,5/3x1,5	5x1,5/5x1,5	5x1,5/5x1,5

1) Scale from A+++ to D. 2) Sound power level in accordance to EN 12102 under conditions of the EN14825. 3) Between outdoor ambient -10 °C and -15 °C, the water outlet temperature gradually decreases from 60 °C to 55 °C. 4) Check local regulations. \* EER and COP calculation is based in accordance to EN 14511. \*\* This product is designed to comply with the European drinking water standard (EU) 2020/2184. The lifespan of the product is not guaranteed in the case of the use of groundwater, such as spring water or well water, the use of tap water when salt or other impurities are contained, nor in areas of acidic water quality. Maintenance and warranty costs related to these cases are the customer's responsibility.

Accessories	
<b>CZ-RTW1</b>	Optional remote controller for 2 zone control. K and L Series
<b>PAW-TD20C1E5-1</b>	Tank 200 L - Stainless steel
<b>PAW-TD30C1E5-1</b>	Tank 300 L - Stainless steel
<b>PAW-TA20C1E5STD</b>	Tank 200 L - Enamelled
<b>PAW-TA30C1E5STD</b>	Tank 300 L - Enamelled
<b>PAW-3WYVLV-HW</b>	3 way valve for DHW tanks
<b>CZ-NV2</b>	3 way valve kit to fit inside the hydrokit. K and L Series

Accessories	
<b>PAW-BTANK50L-2</b>	Buffer tank 50 L
<b>CZ-TAW1C</b>	Optional Wi-Fi or WLAN adapter for smart control via Panasonic Comfort Cloud and/or remote maintenance via Aquarea Service Cloud
<b>CZ-TAW1-CBL</b>	10 m extension cable for CZ-TAW1C
<b>CZ-NS5P</b>	PCB for advanced functions
<b>PAW-A2W-RTWIRED</b>	Room thermostat
<b>PAW-A2W-RTWIREDLESS</b>	Wireless LCD room thermostat



INTERNET CONTROL: Optional.

## Aquarea T-CAP All in One H Series. Three phase. Super Quiet outdoor unit - R410A

**Energy efficiency:** A+++ in heating at 35 °C and A+ in DHW / "A" water pump with variable speed / Stainless steel DHW tank with U-Vacua™ insulation panel / Built-in flow meter.

**Flexibility:** Optional magnet for the water filter.

**Comfort:** Low noise level / Constant capacity down to -20 °C / Operating range down to -28 °C / 60 °C water outlet temperature.

**Control:** Additional functions with optional PCB (2 zone control, bivalent control, Smart Grid contact and more).

**Connectivity:** Optional Aquarea Smart and Service Cloud and integration into BMS projects.

011-1W0510  
011-1W0511

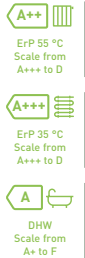

Three phase (power to indoor)					
Kit			KIT-AQC09HE8	KIT-AQC12HE8	KIT-AQC16HE8
Heating capacity / COP (A +7 °C, W 35 °C)		kW / COP	9,00/4,84	12,00/4,74	16,00/4,28
Heating capacity / COP (A +7 °C, W 55 °C)		kW / COP	9,00/2,94	12,00/2,88	16,00/2,71
Heating capacity / COP (A +2 °C, W 35 °C)		kW / COP	9,00/3,59	12,00/3,44	16,00/3,10
Heating capacity / COP (A +2 °C, W 55 °C)		kW / COP	9,00/2,21	12,00/2,19	16,00/2,13
Heating capacity / COP (A -7 °C, W 35 °C)		kW / COP	9,00/2,85	12,00/2,72	16,00/2,49
Heating capacity / COP (A -7 °C, W 55 °C)		kW / COP	9,00/2,02	12,00/1,92	16,00/1,86
Cooling capacity / EER (A 35 °C, W 7 °C)		kW / EER	7,00/3,17	10,00/2,81	12,20/2,57
Cooling capacity / EER (A 35 °C, W 18 °C)		kW / EER	7,00/5,19	10,00/5,13	12,20/3,49
Heating average climate (W 35 °C / W 55 °C)		Seasonal energy efficiency SCOP (η <sub>s</sub> %)	4,59/3,32(181/130)	4,32/3,32(170/130)	4,08/3,20(160/125)
		Energy class <sup>1)</sup>	A+++ to D	A++/A++	A++/A++
Heating warm climate (W 35 °C / W 55 °C)		Seasonal energy efficiency SCOP (η <sub>s</sub> %)	5,95/4,02(235/158)	5,86/4,02(231/158)	5,86/4,05(231/159)
		Energy class <sup>1)</sup>	A+++ to D	A+++/A+++	A+++/A+++
Heating cold climate (W 35 °C / W 55 °C)		Seasonal energy efficiency SCOP (η <sub>s</sub> %)	4,08/3,20(160/125)	4,08/3,20(160/125)	3,83/3,20(150/125)
		Energy class <sup>1)</sup>	A+++ to D	A++/A++	A++/A++
<b>Indoor unit</b>			<b>WH-ADC0916H9E8</b>	<b>WH-ADC0916H9E8</b>	<b>WH-ADC0916H9E8</b>
Sound pressure	Heat / Cool	dB(A)	33/33	33/33	33/33
Dimension	HxWxD	mm	1800x598x717	1800x598x717	1800x598x717
Net weight		kg	126	126	126
Water pipe connector		Inch	R 1½	R 1½	R 1½
A class pump	Number of speeds		Variable speed	Variable speed	Variable speed
	Input power (Min/Max)	W	36/152	36/152	36/152
Heating water flow (ΔT=5 K, 35 °C)		L/min	25,8	34,4	45,9
Electric backup heater		kW	9,00	9,00	9,00
Recommended fuse <sup>2)</sup>		A	16/16	16/16	16/16
Recommended minimum cable size, supply 1 / 2 <sup>2)</sup>		mm <sup>2</sup>	5x1,5/5x1,5	5x1,5/5x1,5	5x1,5/5x1,5
Water volume		L	185	185	185
Maximum DHW temperature		°C	65	65	65
Material inside tank			Stainless steel	Stainless steel	Stainless steel
Tapping profile according EN16147			L	L	L
DHW tank ERP efficiency average / warm / cold <sup>3)</sup>		A+ to F	A/A/A	A/A/A	A/A/B
DHW tank ERP average climate η / COPdHW		η <sub>wh</sub> %/COPdHW	95/2,37	95/2,37	91/2,27
DHW tank ERP warm climate η / COPdHW		η <sub>wh</sub> %/COPdHW	110/2,75	110/2,75	107/2,67
DHW tank ERP cold climate η / COPdHW		η <sub>wh</sub> %/COPdHW	75/1,87	75/1,87	72/1,80
<b>Outdoor unit</b>			<b>WH-UQ09HE8</b>	<b>WH-UQ12HE8</b>	<b>WH-UQ16HE8</b>
Sound power <sup>4)</sup>	Heat	dB(A)	58	58	62
Dimension / Net weight	HxWxD	mm / kg	1410x1283x320/151	1410x1283x320/151	1410x1283x320/161
Refrigerant (R410A) / CO <sub>2</sub> Eq.		kg / T	2,85/5,951	2,85/5,951	2,99/6,243
Piping diameter	Liquid / Gas	Inch (mm)	3/8(9,52)/5/8(15,88)	3/8(9,52)/5/8(15,88)	3/8(9,52)/5/8(15,88)
Pipe length range / Elevation difference (in / out)		m / m	3~30/20	3~30/20	3~30/20
Pre-charged pipe length / Additional gas amount		m / g/m	10/50	10/50	10/50
Operating range - outdoor ambient	Heat	°C	-28~+35	-28~+35	-28~+35
	Cool	°C	+16~+43	+16~+43	+16~+43
Water outlet		Heat / Cool	°C	20~60/5~20	20~60/5~20

1) Scale from A+++ to D. 2) Check local regulations. 3) Scale from A+ to F. 4) Sound power in accordance to 811/2013, 813/2013 and EN 12102-1:2017 at +7 °C. \* EER and COP calculation is based in accordance to EN 14511. \*\* This product is designed to comply with the European drinking water standard (EU) 2020/2184. The lifespan of the product is not guaranteed in the case of the use of groundwater, such as spring water or well water, the use of tap water when salt or other impurities are contained, nor in areas of acidic water quality. Maintenance and warranty costs related to these cases are the customer's responsibility.

Accessories	
<b>CZ-TAW1C</b>	Optional Wi-Fi or WLAN adapter for smart control via Panasonic Comfort Cloud and/or remote maintenance via Aquarea Service Cloud
<b>CZ-TAW1-CBL</b>	10 m extension cable for CZ-TAW1C

Accessories	
<b>CZ-NS4P</b>	PCB for advanced functions
<b>PAW-A2W-MGTFILTER</b>	Magnet for the water filter
<b>PAW-A2W-RTWIRED</b>	Room thermostat
<b>PAW-A2W-RTWIRESLESS</b>	Wireless LCD room thermostat



INTERNET CONTROL: Optional.

## Aquarea T-CAP Bi-bloc H Series. Three phase. Super Quiet outdoor unit - S-QC · R410A

**Energy efficiency:** A+++ in heating at 35 °C / "A" water pump with variable speed / Built-in flow meter.

**Flexibility:** Optional magnet for the water filter.

**Comfort:** Low noise level / Constant capacity down to -20 °C / Operating range down to -28 °C / 60 °C water outlet temperature.

**Control:** Additional functions with optional PCB (2 zone control, bivalent control, Smart Grid contact and more).

**Connectivity:** Optional Aquarea Smart and Service Cloud and integration into BMS projects.



Kit		Three phase (power to indoor)			
Kit		KIT-WQC09H3E8	KIT-WQC12H9E8	KIT-WQC16H9E8	
Heating capacity / COP (A +7 °C, W 35 °C)	kW / COP	9,00/4,84	12,00/4,74	16,00/4,28	
Heating capacity / COP (A +7 °C, W 55 °C)	kW / COP	9,00/2,94	12,00/2,88	16,00/2,71	
Heating capacity / COP (A +2 °C, W 35 °C)	kW / COP	9,00/3,59	12,00/3,44	16,00/3,10	
Heating capacity / COP (A +2 °C, W 55 °C)	kW / COP	9,00/2,21	12,00/2,19	16,00/2,13	
Heating capacity / COP (A -7 °C, W 35 °C)	kW / COP	9,00/2,85	12,00/2,72	16,00/2,49	
Heating capacity / COP (A -7 °C, W 55 °C)	kW / COP	9,00/2,02	12,00/1,92	16,00/1,86	
Cooling capacity / EER (A 35 °C, W 7 °C)	kW / EER	7,00/3,17	10,00/2,81	12,20/2,57	
Cooling capacity / EER (A 35 °C, W 18 °C)	kW / EER	7,00/5,19	10,00/5,13	12,20/3,49	
Heating average climate (W 35 °C / W 55 °C)	Seasonal energy efficiency	SCOP (η <sub>s</sub> %)	4,59/3,32(181/130)	4,32/3,32(170/130)	4,08/3,20(160/125)
	Energy class	A+++ to D	A+++/A++	A++/A++	A++/A++
Heating warm climate (W 35 °C / W 55 °C)	Seasonal energy efficiency	SCOP (η <sub>s</sub> %)	5,95/4,02(235/158)	5,86/4,02(231/158)	5,86/4,05(231/159)
	Energy class	A+++ to D	A+++/A+++	A+++/A+++	A+++/A+++
Heating cold climate (W 35 °C / W 55 °C)	Seasonal energy efficiency	SCOP (η <sub>s</sub> %)	4,08/3,20(160/125)	4,08/3,20(160/125)	3,83/3,20(150/125)
	Energy class	A+++ to D	A++/A++	A++/A++	A++/A++
<b>Indoor unit</b>		<b>WH-SQC09H3E8</b>	<b>WH-SQC12H9E8</b>	<b>WH-SQC16H9E8</b>	
Sound pressure	Heat / Cool	dB(A)	33/33	33/33	
Dimension	H x W x D	mm	892 x 500 x 340	892 x 500 x 340	
Net weight		kg	43	45	
Water pipe connector		Inch	R 1¼	R 1¼	
A class pump	Number of speeds	Variable speed	Variable speed	Variable speed	
	Input power (Min/Max)	W	32/102	34/110	30/105
Heating water flow (ΔT=5 K, 35 °C)		L/min	25,8	34,4	45,9
Electric backup heater		kW	3,00	9,00	9,00
Recommended fuse <sup>1)</sup>		A	15/30	15/30	15/30
Recommended minimum cable size, supply 1 / 2 <sup>1)</sup>		mm <sup>2</sup>	5x1,5/3x1,5	5x1,5/5x1,5	5x1,5/5x1,5
<b>Outdoor unit</b>		<b>WH-UQ09HE8</b>	<b>WH-UQ12HE8</b>	<b>WH-UQ16HE8</b>	
Sound power <sup>2)</sup>	Heat	dB(A)	58	58	62
Dimension	H x W x D	mm	1410 x 1283 x 320	1410 x 1283 x 320	1410 x 1283 x 320
Net weight		kg	151	151	161
Refrigerant (R410A) / CO <sub>2</sub> Eq.		kg / T	2,85/5,951	2,85/5,951	2,99/6,243
Piping diameter	Liquid / Gas	Inch (mm)	3/8(9,52)/5/8(15,88)	3/8(9,52)/5/8(15,88)	3/8(9,52)/5/8(15,88)
Pipe length range		m	3-30	3-30	3-30
Elevation difference (in / out)		m	20	20	20
Pre-charged pipe length		m	10	10	10
Additional gas amount		g/m	50	50	50
Operating range - outdoor ambient	Heat	°C	-28 ~ +35	-28 ~ +35	-28 ~ +35
	Cool	°C	+16 ~ +43	+16 ~ +43	+16 ~ +43
Water outlet	Heat / Cool	°C	20 ~ 60/5 ~ 20	20 ~ 60/5 ~ 20	20 ~ 60/5 ~ 20

1) Check local regulations. 2) Sound power in accordance to 811/2013, 813/2013 and EN 12102-1:2017 at +7 °C. \* EER and COP calculation is based in accordance to EN 14511.

Accessories	
<b>PAW-TD20C1E5-1</b>	Tank 200 L - Stainless steel
<b>PAW-TD30C1E5-1</b>	Tank 300 L - Stainless steel
<b>PAW-TA20C1E5STD</b>	Tank 200 L - Enamelled
<b>PAW-TA30C1E5STD</b>	Tank 300 L - Enamelled
<b>PAW-3WYVLV-HW</b>	3 way valve for DHW tanks
<b>CZ-NV1</b>	3 way valve kit to fit inside the hydrokit. H and J Series
<b>PAW-BTANK50L-2</b>	Buffer tank 50 L

Accessories	
<b>CZ-TAW1C</b>	Optional Wi-Fi or WLAN adapter for smart control via Panasonic Comfort Cloud and/or remote maintenance via Aquarea Service Cloud
<b>CZ-TAW1-CBL</b>	10 m extension cable for CZ-TAW1C
<b>CZ-NS4P</b>	PCB for advanced functions
<b>PAW-A2W-MGTFILTER</b>	Magnet for the water filter
<b>PAW-A2W-RTWIRED</b>	Room thermostat
<b>PAW-A2W-RTWIRELESS</b>	Wireless LCD room thermostat



INTERNET CONTROL: Optional.

## Aquarea Loop, the water loop heat pump for multi-family buildings

The Aquarea Loop is a decentralised water-to-air heat pump using R290, designed to provide heating and cooling for each apartment connected to a central water loop.



### Choice of pre-installed hydraulic options available.

2 and 3 way valves with modulation.

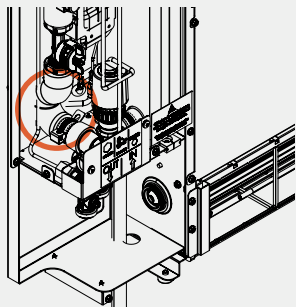

Injection kit.

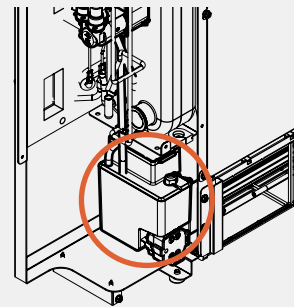

If it is not possible to pipe away condensation, it is possible to reinject it into the system thanks to an optional kit which can be installed inside of the unit.

## Aquarea Loop - R290

- Compact indoor unit – depth of only 140 mm
- DC Inverter compressor with R290
- Cooling in summer
- Use of low centralised loop water temperature of 20 - 30 °C all year round
- Use of existing piping for renovations\*



\* Based on the low flow rate requirement – must be checked on each project.

### Technical features

Model (the complete model codes are shown in the table below)			P-CWSL10	P-CWSL20	P-CWSL30
Cooling capacity <sup>1)</sup>	Nominal (Min - Max)	kW	1,10 (0,20 - 1,20)	1,50 (0,30 - 1,70)	2,60 (0,60 - 3,00)
EER		W/W	4,40	4,80	4,80
SEER <sup>2)</sup>			<b>5,50</b>	<b>6,10</b>	<b>7,90</b>
Input power <sup>1)</sup>		kW	0,2	0,3	0,5
Heating capacity <sup>3)</sup>	Nominal (Min - Max)	kW	1,10 (0,40 - 1,40)	2,00 (0,40 - 2,30)	3,10 (0,80 - 3,60)
COP		W/W	5,20	5,40	5,90
SCOP <sup>2)</sup>			<b>6,44</b>	<b>6,92</b>	<b>6,74</b>
Input power <sup>3)</sup>		kW	0,2	0,4	0,5
<b>Ventilation</b>					
Ventilation speeds			4	4	4
Air flow	Min / Ave / Max	m <sup>3</sup> /h	50/105/160	100/205/330	175/305/500
<b>Electrical data</b>					
Power supply	Voltage	V	230	230	230
	Phase		Single phase	Single phase	Single phase
	Frequency	Hz	50	50	50
Maximum input current		mA	1,74	3,87	5,01
Maximum consumption		kW	0,40	0,89	1,15
<b>Sound levels</b>					
Sound power <sup>4)</sup>	Max	dB(A)	48	50	52
Sound pressure <sup>5)</sup>	Min / Nom / Max	dB(A)	28/33/40	29/34/42	31/35/44
<b>Hydraulic data</b>					
Connection type			Eurokonus	Eurokonus	Eurokonus
Hydraulic connections		Inch	¾	¾	¾
Water flow rate	Heating	L/min	3,7	7,7	12,0
	Cooling	L/min	4,5	5,2	9,0
Nominal pressure drop	Heating	kPa	6,80	11,20	12,50
	Cooling	kPa	4,80	5,40	7,50
Nominal pressure drop with flow control valve	Heating	kPa	7,80	14,20	20,50
	Cooling	kPa	5,40	6,70	11,80
Refrigerant (R290)		kg	0,10	0,14	0,15
<b>Dimension and weight</b>					
Dimension	H x W x D	mm	641 x 775 x 144	641 x 975 x 144	641 x 1225 x 144
Empty weight		kg	35	40	45
<b>Operating range and water outlet</b>					
Operating range - indoor air	Heating	°C	5 - 27	5 - 27	5 - 27
	Cooling	°C	18 - 35	18 - 35	18 - 35
Water outlet	Heating	°C	10 - 45	10 - 45	10 - 45
	Cooling	°C	15 - 50	15 - 50	15 - 50

1) Loop water temperature 30 °C - Ambient air temperature 27 °C, indoor humidity 38% - Performance according to EN 14511. 2) SEER and SCOP in accordance with EN 14825. 3) Ring water temperature 20 °C - Ambient air temperature 20 °C, indoor humidity 50% - Performance according to EN 14511. 4) Sound power measured according to EN 14511. 5) Sound pressure at a distance of 1 m measured according to ISO 7779.

Aquarea Loop with on-board display					
Hydraulic configuration	Without valves		P-CWSL10SC5-HCE	P-CWSL20SC5-HCE	P-CWSL30SC5-HCE
	Without valves + injection kit		P-CWSL10SC5-HFE	P-CWSL20SC5-HFE	P-CWSL30SC5-HFE
	2 and 3 way valve with modulation		P-CWSL10SC5-HBE	P-CWSL20SC5-HBE	P-CWSL30SC5-HBE
	2 and 3 way valve with modulation + injection kit		P-CWSL10SC5-HEE	P-CWSL20SC5-HEE	P-CWSL30SC5-HEE
Aquarea Loop with on-board display with integrated Wi-Fi					
Hydraulic configuration	Without valves		P-CWSL10SC5-WCE	P-CWSL20SC5-WCE	P-CWSL30SC5-WCE
	Without valves + injection kit		P-CWSL10SC5-WFE	P-CWSL20SC5-WFE	P-CWSL30SC5-WFE
	2 and 3 way valve with modulation		P-CWSL10SC5-WBE	P-CWSL20SC5-WBE	P-CWSL30SC5-WBE
	2 and 3 way valve with modulation + injection kit		P-CWSL10SC5-WEE	P-CWSL20SC5-WEE	P-CWSL30SC5-WEE

# Aquarea Air Smart fan coils

Stylish, compact fan coil units for high comfort and energy savings.

+ MORE FAN COIL OPTIONS IN CHILLERS SECTION



## Remote control with Aquarea Home App.

\* Requires Wi-Fi control or Home Network Hub PCZ-ESW737.



Aquarea Home



## AC SELECT.

Smart and user-friendly the new air conditioning selection program: <https://acselect.panasonic.eu/>



Aquarea Air Smart fan coils have a minimal visual impact and can be elegantly integrated into any home or office environment, adapting to any type of furniture.

Designed to provide both heating and cooling in one compact unit, they maximise energy savings when combined with an Aquarea Heat Pumps.

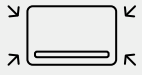

Sophisticated and slim design, with an elegant metal body.

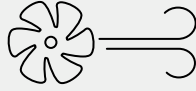

Self-modulated air flow control by the unit (PI logic) and brushless DC fan motor with Inverter.



Versatile with a range of installation options.

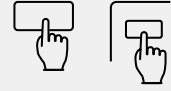

Wide range of control options, including on-board or wall-mounted controls.

### Self-modulated air-flow control by the unit.

The fan speed is no longer "stepped" but continuously modulated with proportional and integrative logic: this reduces both noise and annoying air movements.

### Aquarea Air Smart fan coil floor standing.

Even narrower and thinner fan coils.



### Aquarea Air Smart fan coil wall-mounted.

The thinnest and most quietest in its class.



### Aquarea Air Smart fan coil ducted / ducted thin.

Variable speed, constant air flow.

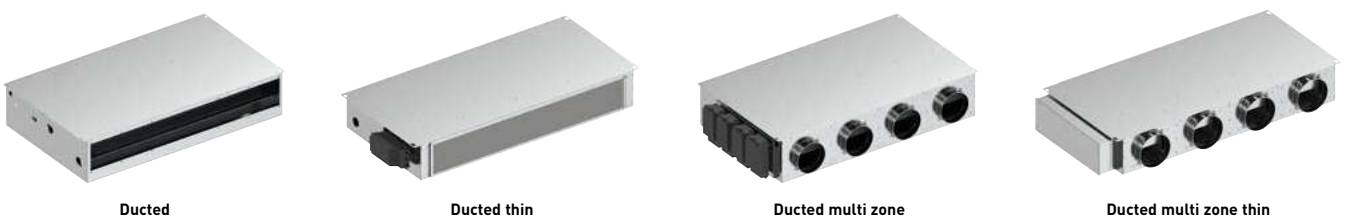

Ducted

Ducted thin

Ducted multi zone

Ducted multi zone thin

## Aquarea Air Smart fan coil floor standing

Slim chassis profile, only 119 mm / RAL 9003 / DC Inverter – maximising comfort and energy savings / Modulated air flow.

**Possible configurations:** Left or right water connections / 2 or 3 way valves as accessories / On-board or wall mounted control or PCB for analog input (0-10 V)



Model (the complete model codes are shown in the table below)		P-FAL10	P-FAL20	P-FAL30	P-FAL35	P-FAL40
<b>Fan speed</b> <sup>1)</sup>		<b>Min / Med / Max</b>	<b>Min / Med / Max</b>	<b>Min / Med / Max</b>	<b>Min / Med / Max</b>	<b>Min / Med / Max</b>
Total cooling capacity <sup>2)</sup>	kW	0,43/0,73/0,91	0,75/1,36/2,12	1,15/2,08/2,81	1,32/2,39/3,30	1,36/2,57/3,71
Sensible capacity <sup>2)</sup>	kW	0,29/0,51/0,71	0,59/1,04/1,54	0,83/1,51/2,11	1,02/1,84/2,65	1,05/1,98/2,90
Water flow <sup>2)</sup>	l/h	73,67/125,07/155,91	128,50/233,01/363,22	197,03/356,36/481,43	226,15/409,48/565,39	—
Water pressure drop <sup>2)3)</sup>	kPa	5,7/10,2/12,1	1,9/4,3/8,2	2,7/9,9/17,1	2,5/8,8/18,0	—
Heating capacity <sup>4)</sup>	kW	0,37/0,69/1,00	0,82/1,50/2,19	1,19/2,15/2,99	1,45/2,56/3,73	1,47/2,78/4,23
Water flow <sup>4)</sup>	l/h	65,11/120,91/179,87	144,60/269,80/389,71	211,61/380,89/532,55	259,22/456,72/671,86	—
Water pressure drop <sup>3)4)</sup>	kPa	2,6/6,8/9,1	1,5/4,3/9,2	2,7/9,3/19,1	3,0/8,9/21,2	—
<b>Sound levels</b>						
Sound power	dB(A)	37/47/54	37/47/54	37/47/57	37/47/55	37/48/58
Sound pressure <sup>5)</sup>	dB(A)	24/33/41	25/34/42	26/34/44	26/35/46	28/38/47
<b>Ventilation</b>						
Number of fans		1	1	1	1	1
Air flow	m <sup>3</sup> /h	49/91/146	124/210/294	194/318/438	302/410/567	364/479/663
Maximum static pressure	Pa	10	10	13	13	13
<b>Electrical data</b>						
Power supply	V / Phase / Hz	V	230/1/50	230/1/50	230/1/50	230/1/50
Consumption	W	7,0/9,0/13,0	14,0/18,0/22,0	16,0/20,0/24,0	18,0/22,0/26,5	—
<b>Water connections</b>						
Hydraulic connections type		Eurokonus	Eurokonus	Eurokonus	Eurokonus	Eurokonus
Hydraulic connections	Inch	¾	¾	¾	¾	¾
<b>Dimension and weight</b>						
Dimension / Weight	H x W x D	mm / kg	580 x 680 x 119/13	580 x 880 x 119/16	580 x 1080 x 119/18	580 x 1280 x 119/20
			580 x 1480 x 119/23			

1) Fan standard factory set speeds. 2) According to Eurovent standard. Air: 27 °C DB/19 °C WB, chilled water: 7 °C/12 °C. 3) Pressure loss by corresponding nominal flow. 4) According to Eurovent standard. Air: 20 °C, hot water: 45 °C/40 °C. 5) Informative data, considering an hypothetical sound attenuation of the room and installation of 9 dB(A).

### Option 1. Standard configurations with built-in accessories

#### Fan coil with on-board display

Left-hand piping, vertical installation, built-in 3 way valve

P-FAL10SC-HLE

P-FAL20SC-HLE

P-FAL30SC-HLE

P-FAL35SC-HLE

P-FAL40SC-HLE

#### Fan coil with wall-mounted control

Left-hand piping, vertical installation, built-in 3 way valve

P-FAL10SC-RLE

P-FAL20SC-RLE

P-FAL30SC-RLE

P-FAL35SC-RLE

P-FAL40SC-RLE

Control (required, to be ordered separately)	With Modbus	<b>PCZ-EEB749</b>
	With integrated Wi-Fi	<b>PCZ-EFB749</b>

### Option 2. Configure your own Aquarea Air Smart fan coil floor standing unit

Left-hand piping	Right-hand piping
------------------	-------------------

P-FAL10SC-00E

P-FAL10DC-00E

P-FAL20SC-00E

P-FAL20DC-00E

P-FAL30SC-00E

P-FAL30DC-00E

P-FAL35SC-00E

P-FAL35DC-00E

P-FAL40SC-00E

P-FAL40DC-00E

<b>Control options (required)</b>	On-board display	With Modbus	<b>PCZ-ECA844</b>
		With integrated Wi-Fi	<b>PCZ-EWA844</b>
	Wall-mounted control	With Modbus	<b>PCZ-ESE845 + PCZ-EEB749</b>
		With integrated Wi-Fi	<b>PCZ-ESE845 + PCZ-EFB749</b>
	PCB for analog control (0-10 V)		<b>PCZ-B10842</b>

<b>Valve kits (optional)</b>	3 way valve with motor	<b>PCZ-V30720</b>
	2 way valve with motor	<b>PCZ-V20139</b>

<b>Condensate drip tray for horizontal installation (optional)</b>	For P-FAL10	<b>PCZ-GB0520</b>
	For P-FAL20	<b>PCZ-GB0521</b>
	For P-FAL30	<b>PCZ-GB0522</b>
	For P-FAL40	<b>PCZ-GB0523</b>
	For P-FAL50	<b>PCZ-GB0524</b>

#### Accessories and options

PCZ-LC0158 Feet for floor pipe cover

#### Accessories and options

PCZ-LC0606 Feet for anchoring the unit to the floor

### Control options.

On-board display with Modbus or integrated Wi-Fi.



Wall-mounted control with Modbus or integrated Wi-Fi.

PCZ-EEB749 /  
PCZ-EFB749



PCB for analog control (0-10 V).

PCZ-B10842

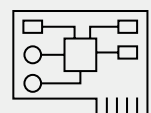



### Aquarea Air Smart fan coil wall-mounted

Slim chassis profile, only 128 mm / RAL 9003 / DC Inverter – maximising comfort and energy savings / Modulated air flow.

**Possible configurations:** Left or right water connections / 2 or 3 way valves as accessories / On-board or wall mounted control or PCB for analog input (0-10 V)

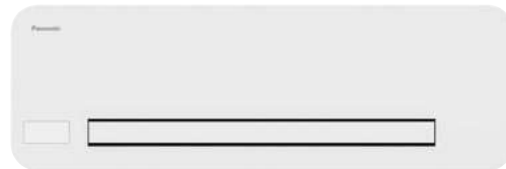

Model [the complete model codes are shown in the table below]			P-FMM10	P-FMM15	P-FMM20	P-FMM40
Fan speed <sup>1)</sup>			Min / Med / Max	Min / Med / Max	Min / Med / Max	Min / Med / Max
Total cooling capacity <sup>2)</sup>	kW		0,49/0,88/1,24	0,62/1,08/1,61	0,70/1,21/1,94	1,32/2,66/3,94
Sensible capacity <sup>2)</sup>	kW		0,37/0,70/0,98	0,52/0,86/1,27	0,57/1,02/1,52	1,08/2,05/2,92
Water flow <sup>2)</sup>	l/h		84,00/150,80/212,40	106,20/185,00/275,80	119,90/207,30/332,40	226,40/455,30/674,30
Water pressure drop <sup>2)</sup>	kPa		4,8/10,5/11,7	4,7/5,6/5,1	5,5/5,4/5,3	1,8/6,0/12,1
Heating capacity <sup>3)</sup>	kW		0,54/0,98/1,45	0,76/1,30/1,93	0,78/1,49/2,28	1,63/3,04/4,44
Water flow <sup>3)</sup>	l/h		97,00/176,30/264,50	139,30/239,80/354,40	141,10/273,30/414,40	296,40/547,00/800,90
Water pressure drop <sup>3)</sup>	kPa		5,1/12,0/16,3	4,8/6,3/7,2	6,0/6,4/8,1	2,3/6,9/14,1
<b>Sound levels</b>						
Sound power	dB(A)		35/46/53	36/47/54	37/48/58	38/48/62
Sound pressure <sup>4)</sup>	dB(A)		25/33/40	25/34/41	26/34/42	27/37/51
<b>Ventilation</b>						
Air flow	m <sup>3</sup> /h		84/155/228	124/229/331	138/283/440	230/480/788
<b>Electrical data</b>						
Power supply	V / Phase / Hz	V	230/1/50	230/1/50	230/1/50	230/1/50
Consumption		W	5/8/19	5/9/20	5/11/29	8/23/30
<b>Water connections</b>						
Hydraulic connections type			Eurokonus	Eurokonus	Eurokonus	Eurokonus
Hydraulic connections	Inch		¾	¾	¾	¾
<b>Dimension and weight</b>						
Dimension / Weight	HxWxD	mm / kg	335x815x128/14	335x1015x128/16	335x1215x128/19	335x1215x215/24

1) Fan standard factory set speeds. 2) According to Eurovent standard. Air: 27 °C DB/19 °C WB, chilled water: 7 °C/12 °C. 3) According to Eurovent standard. Air: 20 °C, hot water: 45 °C/40 °C. 4) Informative data, considering an hypothetical sound attenuation of the room and installation of 9 dB(A).

#### Option 1. Standard configurations with built-in accessories

Fan coil with on-board display and wireless IR control		
Right-hand piping, built-in 3 way valve		
P-FMM10DC-QNE		
P-FMM15DC-QNE		
P-FMM20DC-QNE		
P-FMM40DC-QNE		
Fan coil with wall-mounted control		
Right-hand piping, built-in 3 way valve		
P-FMM10DC-RNE		
P-FMM15DC-RNE		
P-FMM20DC-RNE		
P-FMM40DC-RNE		
Control (required, to be ordered separately)	With Modbus	PCZ-EEB749
	With integrated Wi-Fi	PCZ-EFB749

#### Option 2. Configure your own Aquarea Air Smart fan coil wall-mounted unit

Fan coil with on-board display and wireless IR control		
Left-hand piping	Right-hand piping	
P-FMM10SC-Q0E	P-FMM10DC-Q0E	
P-FMM15SC-Q0E	P-FMM15DC-Q0E	
P-FMM20SC-Q0E	P-FMM20DC-Q0E	
—	P-FMM40DC-Q0E	
Fan coil with wall-mounted control		
Left-hand piping	Right-hand piping	
P-FMM10SC-R0E	P-FMM10DC-R0E	
P-FMM15SC-R0E	P-FMM15DC-R0E	
P-FMM20SC-R0E	P-FMM20DC-R0E	
—	P-FMM40DC-R0E	
Control (required, to be ordered separately)	With Modbus	PCZ-EEB749
	With integrated Wi-Fi	PCZ-EFB749
Fan coil with PCB for analog control (0-10 V)		
Left-hand piping	Right-hand piping	
P-FMM10SC-V0E	P-FMM10DC-V0E	
P-FMM15SC-V0E	P-FMM15DC-V0E	
P-FMM20SC-V0E	P-FMM20DC-V0E	
—	P-FMM40DC-V0E	
Valve kits (optional)		
PCZ-V30688	3 way valve with motor for models 10, 15, 20	
PCZ-V30718	3 way valve with motor for model 40	
PCZ-V20687	2 way valve with motor for models 10, 15, 20	
PCZ-V20139	2 way valve with motor for model 40	

#### Control options.

On-board display with Modbus or integrated Wi-Fi.



Wall-mounted control with Modbus or integrated Wi-Fi.

PCZ-EEB749 / PCZ-EFB749



PCB for analog control (0-10 V).

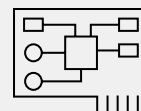

**Aquarea Air Smart fan coil ducted thin / ducted****Fan coil ducted units with cooling and heating.****Cooling capacity: 0,7 to 5,3 kW.****Heating capacity: 0,7 to 5,8 kW.**

Optional controller.  
Wall-mounted control  
with Modbus.  
PCZ-EEB749



Optional controller.  
Wall-mounted control  
with integrated Wi-Fi.  
PCZ-EFB749



Optional controller.  
PCB for analog control  
(0-10 V).

+ CHECK PAGE 128 FOR A WIDER SELECTION OF ACCESSORIES

**The range at a glance**

- Slim profile, only 185 mm for the thin version
- DC Inverter – maximising comfort and energy savings
- Modulated air flow
- Quiet operation
- Centrifugal fan with single motor impeller
- Vertical or horizontal installation

**Possible configurations**

- Left or right water connections
- 2 or 3 way valves as accessories
- Wall-mounted control or PCB for analog input (0-10 V)

**High efficiency ducted fan coil for high comfort and quiet operation thanks to self modulating airflow control.**

**Ducted thin, designed to fit any space**

With a height of only 185 mm, the thin version is even more versatile than the classic version and fits perfectly into any wall or false ceiling with either horizontal or vertical installation.

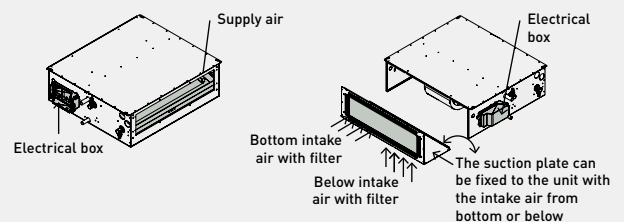
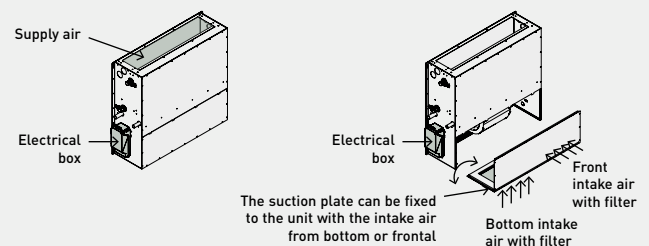
**Ducted thin****High installation flexibility.****Horizontal installation.****Vertical installation.**

Technical features

		Ducted thin					Ducted					
Model (the complete model codes are shown in the table below)		P-FTN15	P-FTN20	P-FTN25	P-FTN35	P-FTN45	P-FSN20	P-FSN25	P-FSN35	P-FSN45	P-FSN55	
Fan speed <sup>1)</sup>		Min / Med / Max	Min / Med / Max	Min / Med / Max	Min / Med / Max	Min / Med / Max	Min / Med / Max	Min / Med / Max	Min / Med / Max	Min / Med / Max	Min / Med / Max	
Total cooling capacity <sup>2)</sup>	kW	0,66/1,14 /1,40	1,01/1,84 /2,10	1,23/2,17 /2,60	1,47/2,40 /3,30	1,72/2,80 /4,45	0,82/1,37 /1,88	1,27/1,86 /2,14	1,53/2,38 /2,97	1,81/3,22 /3,48	1,82/3,97 /5,31	
Sensible capacity <sup>2)</sup>	kW	0,46/0,84 /1,05	0,70/1,27 /1,50	0,88/1,56 /2,10	1,06/1,77 /2,45	1,23/2,33 /3,20	0,61/0,96 /1,48	0,93/1,43 /1,56	1,17/1,98 /2,92	1,33/2,58 /2,95	1,33/2,75 /3,65	
Water flow <sup>2)</sup>	l/h	113/195 /270	173/315 /405	211/373 /510	251/412 /610	295/481 /805	141/235 /322	218/319 /367	262/408 /509	310/552 /596	312/680 /910	
Water pressure drop <sup>2)3)</sup>	kPa	1,0/3,0 /5,0	2,0/5,0 /8,0	4,0/10,0 /17,0	2,0/5,0 /11,0	2,0/6,0 /14,0	9,2/11,8 /15,7	9,9/14,9 /19,4	2,4/2,8 /2,9	9,0/12,6 /14,6	4,1/16,1 /27,2	
Heating capacity <sup>4)</sup>	kW	0,68/1,32 /1,65	1,01/1,80 /2,10	1,32/2,32 /2,86	1,63/2,76 /3,71	1,89/3,98 /5,20	0,9/1,48 /1,98	1,36/2,04 /2,54	1,81/2,63 /3,45	1,96/3,77 /4,46	1,95/4,23 /5,73	
Water flow <sup>4)</sup>	l/h	115/222 /310	170/303 /440	235/410 /540	288/486 /730	329/692 /880	159/261 /349	239/360 /448	319/464 /608	346/665 /787	347/754 /1025	
Water pressure drop <sup>3)4)</sup>	kPa	1,0/3,0 /6,0	2,0/5,0 /9,0	4,0/11,0 /18,0	2,0/6,0 /13,0	3,0/10,0 /15,0	51/12,0 /16,3	10,3/15,6 /21,5	2,6/2,8 /2,9	9,2/15,6 /18,4	4,0/16,4 /29,3	
<b>Sound levels</b>												
Sound power	dB(A)	42/47/53	44/51/58	45/52/58	46/54/60	47/54/61	46/54/58	46/54/58	46/54/57	47/55/58	48/55/60	
<b>Ventilation</b>												
Number of fans		1	1	2	2	3	1	1	2	2	3	
Air flow	m <sup>3</sup> /h	90/200/290	140/290/390	190/390/550	230/450/680	250/610/870	120/260/390	180/350/560	240/440/730	260/550/905	280/750/1150	
Maximum static pressure	Pa	100	90	120	110	140	90	130	110	140	140	
<b>Electrical data</b>												
Power supply	Voltage	V	230	230	230	230	230	230	230	230	230	
	Phase		Single phase	Single phase	Single phase	Single phase	Single phase	Single phase	Single phase	Single phase	Single phase	
	Frequency	Hz	50	50	50	50	50	50	50	50	50	
Consumption	W	14/32/80	22/55/140	26/65/160	33/80/160	38/115/230	6/11/24	7/14/31	8/16/34	13/30/38	14/42/85	
Degree of protection	IP	X0	X0	X0	X0	X0	X0	X0	X0	X0	X0	
<b>Connections</b>												
Hydraulic connections type		Eurokonus	Eurokonus	Eurokonus	Eurokonus	Eurokonus	Eurokonus	Eurokonus	Eurokonus	Eurokonus	Eurokonus	
Hydraulic connections	Inch	¾	¾	¾	¾	¾	¾	¾	¾	¾	¾	
Condensate drainage connection	mm	20	20	20	20	20	20	20	20	20	20	
Intake air connection (base x height)	mm	460 x 100	660 x 100	860 x 100	1060 x 100	1320 x 100	460 x 150	660 x 150	860 x 150	1060 x 150	1320 x 150	
Return air connection (base x height)	mm	510 x 100	710 x 100	910 x 100	1110 x 100	1370 x 100	510 x 150	710 x 150	910 x 150	1110 x 150	1370 x 150	
<b>Dimension and weight</b>												
Dimension	H x W x D	mm	185 x 590 x 575	185 x 790 x 575	185 x 990 x 575	185 x 1190 x 575	185 x 1440 x 575	240 x 590 x 695	240 x 790 x 695	240 x 990 x 695	240 x 1190 x 695	240 x 1440 x 695
Weight	kg	30	41	45	54	65	32	43	47	56	67	

1) Fan standard factory set speeds. 2) According to Eurovent standard. Air: 27 °C DB/19 °C WB, chilled water: 7 °C/12 °C. 3) Pressure loss by corresponding nominal flow. 4) According to Eurovent standard. Air: 20 °C, hot water: 45 °C/40 °C.

Configure your own Aquarea Air Smart fan coil ducted thin / ducted unit

Fan coil with wall-mounted control		
Left-hand piping	Right-hand piping	
P-FTN15005-RE	P-FTN15R05-RE	
P-FTN20005-RE	P-FTN20R05-RE	
P-FTN25005-RE	P-FTN25R05-RE	
P-FTN35005-RE	P-FTN35R05-RE	
P-FTN45005-RE	P-FTN45R05-RE	
P-FSN20005-RE	P-FSN20R05-RE	
P-FSN25005-RE	P-FSN25R05-RE	
P-FSN35005-RE	P-FSN35R05-RE	
P-FSN45005-RE	P-FSN45R05-RE	
P-FSN55005-RE	P-FSN55R05-RE	
Control (required, to be ordered separately)	With Modbus	PCZ-EEB749
	With integrated Wi-Fi	PCZ-EFB749

Fan coil with PCB for analog control (0-10 V)		
Left-hand piping	Right-hand piping	
P-FTN15005-JE	P-FTN15R05-JE	
P-FTN20005-JE	P-FTN20R05-JE	
P-FTN25005-JE	P-FTN25R05-JE	
P-FTN35005-JE	P-FTN35R05-JE	
P-FTN45005-JE	P-FTN45R05-JE	
P-FSN20005-JE	P-FSN20R05-JE	
P-FSN25005-JE	P-FSN25R05-JE	
P-FSN35005-JE	P-FSN35R05-JE	
P-FSN45005-JE	P-FSN45R05-JE	
P-FSN55005-JE	P-FSN55R05-JE	

Valve kits (optional)	
PCZ-V30361	3 way valve with motor
PCZ-V20139	2 way valve with motor

**Aquarea Air Smart fan coil ducted multi zone thin / ducted multi zone**

Fan coil ducted units with cooling and heating.

Cooling capacity: 0,5 to 7,6 kW.

Heating capacity: 0,5 to 8,52 kW.



Optional controller.  
Wall-mounted control  
with Modbus.  
PCZ-EEB749



Optional controller.  
Wall-mounted control  
with integrated Wi-Fi.  
PCZ-EFB749



Optional controller.  
PCB for analog control  
(0-10 V).

**+** CHECK PAGE 132 FOR A WIDER SELECTION OF ACCESSORIES

**The range at a glance**

- Multi zone management (2-5 zones)
- Slim profile, only 185 mm for the thin version
- DC Inverter – maximising comfort and energy savings
- Modulated air flow
- Quiet operation
- Centrifugal fan with single motor impeller

**Possible configurations**

- Left or right water connections
- 2 or 3 way valves as accessories
- Wall-mounted control or PCB for analog input (0-10 V)

**The ducted Smart fan coil unit with integrated multi zone management.**

**High installation flexibility.**

**Single air outlet per zone.**



**Example:**  
3 air outlets for 3 independent zones.

**Multiple air outlets per zone.**



**Example:**  
3 air outlets for 2 independent zones.  
Zone 1 with dual channel.  
Zone 2 with single channel.

**Multi zone management**

Thanks to integrated multi zone management and the use of forward-bladed centrifugal brushless EC multi-fans, the fan coil ducted multi zone allow independent management of the different thermal zones, resulting in benefits in terms of efficiency, comfort and quietness.



**1 | Air supply plate.**  
Built-in air supply plate, number of outlets depending on unit size.

- P-FTQ30/P-FSQ30: 2 outlets DN 160 mm
- P-FTQ45/P-FSQ45: 3 outlets DN 160 mm
- P-FTQ60/P-FSQ60: 4 outlets DN 160 mm
- P-FTQ65/P-FSQ75: 5 outlets DN 160 mm

**2 | Fans.**  
Integrated multi-fans for independent management of the different zones.

**3 | Horizontal condensate tray.**  
Allows the collection of condensate if the unit is installed horizontally.

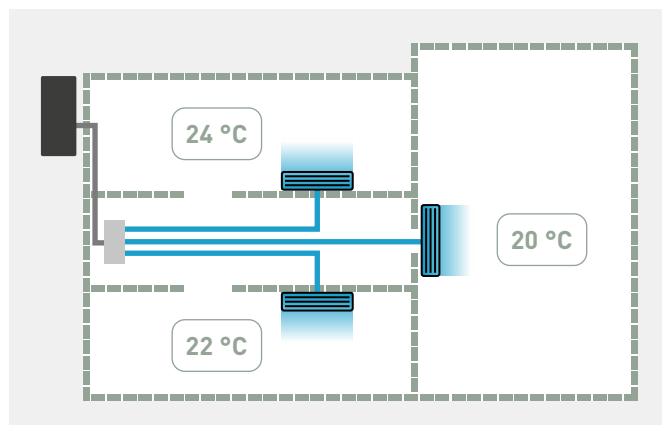

Technical features

		Ducted multi zone thin				Ducted multi zone				
Model		P-FTQ30	P-FTQ45	P-FTQ60	P-FTQ65	P-FSQ30	P-FSQ45	P-FSQ60	P-FSQ75	
<small>(the complete model codes are shown in the table below)</small>										
Fan speed <sup>1)</sup>		Min / Med / Max	Min / Med / Max	Min / Med / Max	Min / Med / Max	Min / Med / Max	Min / Med / Max	Min / Med / Max	Min / Med / Max	
Total cooling capacity <sup>2)</sup>	kW	1,10/1,97 /3,02	1,16/2,97 /4,40	2,02/3,68 /5,70	2,09/4,15 /6,40	0,47/3,80 /3,23	0,66/3,77 /4,57	0,85/4,87 /5,88	1,06/6,31 /7,61	
Sensible capacity <sup>2)</sup>	kW	0,76 /1,37 /2,15	0,79/2,09 /3,16	1,45/2,67 /4,10	1,61/3,08 /4,60	0,33/2,70 /2,22	0,48/2,62 /3,16	0,63/3,40 /4,10	0,78/4,32 /5,20	
Single zone cooling capacity <sup>2)</sup>	kW	0,49/1,30 /1,70	0,49/1,30 /1,70	0,49/1,30 /1,70	0,49/1,30 /1,70	-/-/2,10	-/-/2,10	-/-/2,10	-/-/2,10	
Single zone sensible capacity <sup>2)</sup>	kW	0,31/0,89 /1,23	0,31/0,89 /1,23	0,31/0,89 /1,23	0,31/0,89 /1,23	-/-/1,50	-/-/1,50	-/-/1,50	-/-/1,50	
Water flow <sup>2)</sup>	l/h	190/338 /530	200/510 /800	346/630 /1030	358/713 /1220	80/651 /553	113/647 /782	146/834 /1008	182,3/1081 /1304	
Water pressure drop <sup>2)3)</sup>	kPa	4,0/11,0/22,0	2,0/9,0/18,0	3,0/9,0/18,0	1,0/4,0/9,0	1,8/29,0/54,1	1,2/25,7/36,4	1,0/20,2/28,5	1,6/37,3/52,6	
Heating capacity <sup>4)</sup>	kW	1,15/2,11 /3,30	1,71/3,19 /4,90	-/5,76/6,30	2,67/4,75 /7,65	0,45/3,90 /3,61	0,68/4,16 /5,08	0,90/5,42 /6,59	1,13/6,87 /8,37	
Single zone heating capacity <sup>4)</sup>	kW	0,42/1,29 /1,85	0,42/1,29 /1,85	0,42/1,29 /1,85	0,42/1,29 /1,85	-/-/2,20	-/-/2,20	-/-/2,20	-/-/2,20	
Water flow <sup>4)</sup>	l/h	200/368 /560	296/554 /800	391/699 /1110	464/826 /1305	80/688 /636	120/748 /914	159/975 /1189	199/1230 /1502	
Water pressure drop <sup>3)4)</sup>	kPa	4,0/13,0/25,0	3,0/10,0/19,0	3,0/10,0/18,0	2,0/5,0/10,0	1,4/29,0/61,2	1,1/28,9/42,3	0,9/23,1/33,7	1,5/41,4/60,6	
<b>Sound levels</b>										
Sound power	dB(A)	40/49/58	42/50/59	42/52/61	43/53/62	-/-/60	-/-/61	-/-/62	-/-/64	
<b>Ventilation</b>										
Number of fans		2	3	4	5	2	3	4	5	
Air flow	m <sup>3</sup> /h	145/290 /480	215/435 /720	288/576 /960	360/720 /1200	60/600 /810	90/900 /1215	120/1200 /1620	150/1500 /2025	
Single zone air flow	m <sup>3</sup> /h	50/160/240	50/160/240	50/160/240	50/160/240	60/205/300	60/205/300	60/205/300	60/205/300	
Maximum static pressure	Pa	100	100	100	100	100	100	100	100	
<b>Electrical data</b>										
Power supply	Voltage	V	230	230	230	230	230	230	230	
	Phase		Single phase	Single phase	Single phase	Single phase	Single phase	Single phase	Single phase	
	Frequency	Hz	50	50	50	50	50	50	50	
Consumption	W	31/66/130	45/102/195	61/135/260	76/162/325	53/140/178	159/420/534	212/560/712	265/700/890	
Degree of protection	IP	X0	X0	X0	X0	X0	X0	X0	X0	
<b>Connections</b>										
Hydraulic connections type		Eurokonus	Eurokonus	Eurokonus	Eurokonus	Eurokonus	Eurokonus	Eurokonus	Eurokonus	
Hydraulic connections	Inch	¾	¾	¾	¾	¾	¾	¾	¾	
Condensate drainage connection	mm	20	20	20	20	20	20	20	20	
Intake air connection (base x height)	mm	160	160	160	160	160	160	160	160	
Return air connection (base x height)	mm	630 x 100	830 x 100	1030 x 100	1320 x 100	630 x 150	830 x 150	1030 x 150	1320 x 150	
<b>Dimension and weight</b>										
Dimension	H x W x D	mm	185 x 790 x 575	185 x 990 x 575	185 x 1190 x 575	185 x 1440 x 575	240 x 790 x 695	240 x 990 x 695	240 x 1190 x 695	240 x 1440 x 695
Weight	kg	41	45	54	56	43	47	56	67	

1) Fan standard factory set speeds. 2) According to Eurovent standard. Air: 27 °C DB/19 °C WB, chilled water: 7 °C/12 °C. 3) Pressure loss by corresponding nominal flow. 4) According to Eurovent standard. Air: 20 °C, hot water: 45 °C/40 °C.

Configure your own Aquarea Air Smart fan coil ducted multi zone thin / ducted multi zone unit

Fan coil with wall-mounted control			Fan coil with PCB for analog control (0-10 V)		
Left-hand piping	Right-hand piping		Left-hand piping	Right-hand piping	
P-FTQ30005-RE	P-FTQ30R05-RE		P-FTQ30005-JE	P-FTQ30R05-JE	
P-FTQ45005-RE	P-FTQ45R05-RE		P-FTQ45005-JE	P-FTQ45R05-JE	
P-FTQ60005-RE	P-FTQ60R05-RE		P-FTQ60005-JE	P-FTQ60R05-JE	
P-FTQ65005-RE	P-FTQ65R05-RE		P-FTQ65005-JE	P-FTQ65R05-JE	
P-FSQ30005-RE	P-FSQ30R05-RE		P-FSQ30005-JE	P-FSQ30R05-JE	
P-FSQ45005-RE	P-FSQ45R05-RE		P-FSQ45005-JE	P-FSQ45R05-JE	
P-FSQ60005-RE	P-FSQ60R05-RE		P-FSQ60005-JE	P-FSQ60R05-JE	
P-FSQ75005-RE	P-FSQ75R05-RE		P-FSQ75005-JE	P-FSQ75R05-JE	
Control (required, to be ordered separately)	With Modbus	PCZ-EEB749			
	With integrated Wi-Fi	PCZ-EFB749			
<b>Valve kits (optional)</b>					
PCZ-V30361	3 way valve with motor				
PCZ-V20139	2 way valve with motor				

Fan coil comfort AC fan

Fan coil floor and ceiling units with cooling and heating.

Cooling capacity: 0,6 to 6,9 kW.

Heating capacity: 0,6 to 7,4 kW.



Optional controller. WRC remote control.



Optional controller. SRC - mini BMS controller.



Optional controller. Electronic controller TControl POD glass.



Optional controller. Electronic controller TControl EASY 3S.



Optional controller. Wired remote controller with touch control. PAW-FC-907AC



Optional controller. Wired remote controller. PAW-FC-903AC



Optional controller. Advanced wired remote controller. PAW-FC-RC1

Operating limits

Entering water temperature (without glycol).

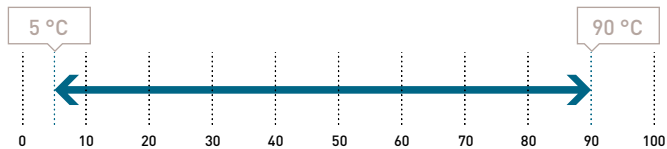

Indoor air temperature.

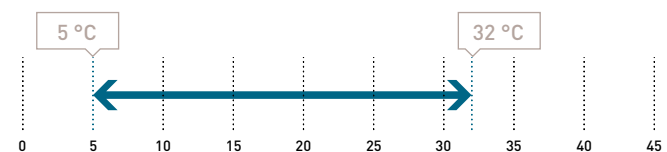

The range at a glance

- Versions: 2-pipes, 2-pipes + electric heater and 4-pipes
- 7 sizes
- 5-speed AC fan - standard factory set speeds: S1,S3,S5
- Air flow from 94 to 1064 m<sup>3</sup>/h
- Configuration: universal installation units (vertical or horizontal) with or without cabinet
- Left or right water connections
- Many air inlet/outlet configurations
- G2 air filter (G3 as an option)

Advantages

- Silent units
- New casing design for an increased robustness
- Harmonious and aesthetic RAL 9003 painted cabinet
- Valves, condensate drain pan and drain pump factory mounted
- 100% factory tested

Accessories and options

- 2 way or 3 way valves
- 4-pipes kit (additional coil)
- Circuit breakers
- Drain pump
- Electric heaters (from 500 W to 2500 W)
- Feet with/without grid
- Fuse holders
- G3 filter
- Horizontal or vertical drain guard (with valve)
- Many air inlet/outlet configurations
- Mechanical sensor for automatic change over
- Modbus communication board for Plogic
- MRC/WRC/BRC: remote controls for Plogic
- Other speeds configuration (standard factory set speeds: S1,S3,S5)
- SRC - mini BMS controller
- Suspension kit
- Plogic controller (other electromechanical or electronic control systems also available)
- TControl EASY 3S and TControl POD glass controllers (other electromechanical or electronic control systems also available)

+ SEE PAGE 582 FOR MORE DETAILS ABOUT FAN COIL CONTROLLERS

AC SELECT.

Smart and user-friendly the new air conditioning selection program: <https://acselect.panasonic.eu/>



Technical features

Fan coil comfort AC fan		P-FC10		P-FC20		P-FC30		P-FC40		P-FC50		P-FC60		P-FC70		
		S1/S3/S5 <sup>1)</sup>		S1/S3/S5 <sup>1)</sup>		S1/S3/S5 <sup>1)</sup>		S1/S3/S5 <sup>1)</sup>		S1/S3/S5 <sup>1)</sup>		S1/S3/S5 <sup>1)</sup>		S1/S3/S5 <sup>1)</sup>		
<b>2-pipes</b>																
Total cooling capacity <sup>2)</sup>	kW	0,66/1,00/1,45		0,61/0,96/1,38		0,95/1,88/2,37		1,14/2,28/3,02		1,71/3,16/4,64		2,57/4,33/5,53		3,24/5,84/6,91		
Sensible capacity <sup>2)</sup>	kW	0,48/0,77/1,05		0,43/0,70/1,02		0,78/1,44/1,80		0,83/1,66/2,23		1,24/2,23/3,27		1,81/3,14/4,25		2,26/4,11/4,85		
Water flow <sup>2)</sup>	l/h	114/172/250		105/165/238		164/324/408		196/393/520		295/544/799		443/746/953		558/1006/1190		
Water pressure drop <sup>2) 3)</sup>	kPa	9,17/19,5/39,1		2,65/4,62/7,43		5,8/17,6/26,3		5,0/15,6/25,6		7,5/22,8/47,1		12,6/33,9/54,4		4,4/13,9/19,4		
Heating capacity <sup>4)</sup>	kW	0,63/1,18/1,71		0,63/1,03/1,53		1,00/1,86/2,49		1,14/2,28/3,18		1,79/3,47/4,81		2,45/4,22/5,63		3,45/6,27/7,41		
Water flow <sup>4)</sup>	l/h	109/203/295		109/177/264		172/320/429		196/393/548		308/598/829		422/727/970		594/1080/1276		
Water pressure drop <sup>2) 4)</sup>	kPa	5,9/17,3/33,8		2,76/5,06/8,54		5,8/16,2/27,0		5,0/15,6/28,1		6,1/20,7/38,5		18,6/52,4/91,4		4,9/16,0/22,3		
<b>4-pipes</b>																
Total cooling capacity <sup>2)</sup>	kW	0,63/0,88/1,24		0,87/1,34/1,73		0,91/1,80/2,28		0,98/2,14/2,85		1,57/2,88/4,13		2,60/4,39/5,61		3,17/5,62/6,58		
Sensible capacity <sup>2)</sup>	kW	0,46/0,67/0,91		0,65/1,02/1,36		0,75/1,39/1,74		0,71/1,57/2,10		1,14/2,04/2,92		1,82/3,18/4,28		2,21/3,96/4,62		
Water flow <sup>2)</sup>	l/h	109/152/214		150/231/298		157/310/393		169/369/491		270/496/711		448/756/966		546/968/1133		
Water pressure drop <sup>2) 3)</sup>	kPa	7,6/13,9/26,3		2,33/4,44/6,64		2,8/8,6/13,1		5,8/20,5/33,6		3,9/11,6/22,8		10,2/27,7/44,5		5,3/16,2/22,1		
Heating capacity <sup>5)</sup>	kW	0,63/1,00/1,41		1,00/1,40/1,68		1,28/1,81/2,13		1,22/2,21/2,85		2,01/3,19/4,08		2,71/4,24/5,33		3,65/5,00/5,90		
Water flow <sup>5)</sup>	l/h	54/86/121		86,1/121/145		110/156/183		105/190/245		173/275/351		233/365/459		314/431/508		
Water pressure drop <sup>2) 5)</sup>	kPa	1,2/2,1/3,3		1,15/2,2/3,12		2,8/4,7/6,1		5,1/13,9/21,8		5,7/12,5/19,4		11,6/24,8/37		35,4/60,7/81,2		
<b>Sound levels</b>																
Sound power	2-pipes	dB(A)	33/40/49		31/43/50		30/45/52		30/44/51		34/43/56		38/51/58		43/56/61	
	4-pipes	dB(A)	33/40/49		31/43/50		30/45/52		30/44/51		34/46/56		38/51/58		43/56/61	
Sound pressure <sup>6)</sup>	2-pipes	dB(A)	24/31/40		22/34/41		21/36/43		21/35/42		25/37/47		29/42/49		34/47/52	
	4-pipes	dB(A)	24/31/40		22/34/41		21/36/43		21/35/42		25/37/47		29/42/49		34/47/52	
NR <sup>6)</sup>	2-pipes		19/26/35		17/29/36		16/31/38		16/30/37		20/32/42		24/37/44		29/42/47	
	4-pipes		19/26/35		17/29/36		16/31/38		16/30/37		20/32/42		24/37/44		29/42/47	
<b>Ventilation</b>																
Number of fans			1		1		1		2		2		2		2	
Air flow	2-pipes	m <sup>3</sup> /h	94/190/283		68/104/196		138/274/390		173/357/499		253/486/716		350/640/933		480/893/1064	
	4-pipes	m <sup>3</sup> /h	95/168/253		89/161/241		132/263/369		148/335/467		242/466/671		334/614/885		470/859/1012	
Filter			G2		G2		G2		G2		G2		G2		G2	
<b>Electrical data</b>																
Power supply	Voltage	V	230		230		230		230		230		230		230	
	Phase		Single phase		Single phase		Single phase		Single phase		Single phase		Single phase		Single phase	
	Frequency	Hz	50/60		50/60		50/60		50/60		50/60		50/60		50/60	
Consumption	2-pipes	W	13/24/36		13/18/31		16/37/45		15/37/56		28/55/72		37/75/105		53/100/147	
	4-pipes	W	13/24/36		11/18/28		16/37/44		15/37/55		28/54/70		37/74/104		53/99/145	
Electric heater	W	500		500		500/1000		1250		1250/2500		1250/2500		1250/2500		
<b>Water connections</b>																
Connection type			Female gas threaded		Female gas threaded		Female gas threaded		Female gas threaded		Female gas threaded		Female gas threaded		Female gas threaded	
2 or 4-pipes	Cooling	Inch	½		½		½		½		½		½		¾	
4-pipes	Heating	Inch	½		½		½		½		½		½		½	
<b>Dimension</b>																
With cabinet - without feet	H x W x D	mm	477 x 766 x 225		477 x 766 x 225		477 x 951 x 225		477 x 1136 x 225		477 x 1321 x 225		477 x 1506 x 225		575 x 1319 x 225	
Without cabinet	H x W x D	mm	430 x 570 x 220		430 x 570 x 220		430 x 753 x 220		430 x 938 x 220		430 x 1122 x 220		430 x 1307 x 220		530 x 1121 x 220	
<b>Weight</b>																
With cabinet	2 / 4-pipes	kg	19/20		19/20		22/23		27/29		30/32		35/37		35/37	
Without cabinet	2 / 4-pipes	kg	13/14		13/14		15/16		20/22		22/24		26/28		27/29	

Energy efficiency class <sup>7)</sup>

Fan coil comfort AC fan									
2-pipes	FCEER	A to E	E	E	D	D	D	D	D
	FCCOP	A to E	E	E	E	E	E	E	E
4-pipes	FCEER	A to E	E	D	D	D	E	D	D
	FCCOP	A to E	E	D	D	D	E	E	E

1) Fan standard factory set speeds. 2) According to Eurovent standard. Air: 27 °C DB/19 °C WB, chilled water: 7 °C/12 °C. 3) Pressure loss by corresponding nominal flow. 4) According to Eurovent standard. Air: 20 °C, hot water: 45 °C/40 °C. 5) According to Eurovent standard. Air: 20 °C, hot water: 65 °C/55 °C. 6) Informative data, considering an hypothetical sound attenuation of the room and installation of 9 dB(A). 7) According to Eurovent. \* Standard configuration with left hand hydraulic connection. G2 air filter included as standard.

Control options.

Optional wired remote controller for AC fan, 2-pipe and 4-pipe application.  
PAW-FC-RC1



Optional wired remote controller for AC fan 2-pipe application.  
PAW-FC-903AC / PAW-FC-907AC



Optional wired remote controller for EC fan, 2-pipe and 4-pipe application.  
PAW-FC-903EC / PAW-FC-907EC



ErP compliant following COMMISSION REGULATION (EU) 2016/2281.



Fan coil comfort EC fan

Fan coil floor and ceiling units with cooling and heating.

Cooling capacity: 0,5 to 9,1 kW.

Heating capacity: 0,6 to 12,9 kW.



Optional controller.  
WRC remote control.



Optional controller.  
SRC - mini BMS controller.



Optional controller.  
Electronic controller  
TControl POD glass.



Optional controller.  
Electronic controller  
TControl EASY 3S.



Optional controller.  
Wired remote controller  
with touch control.  
PAW-FC-907EC



Optional controller.  
Wired remote controller.  
PAW-FC-903EC

Operating limits

Entering water temperature (without glycol).

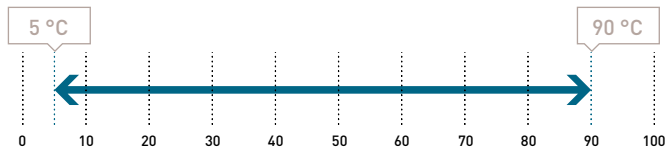

Indoor air temperature.

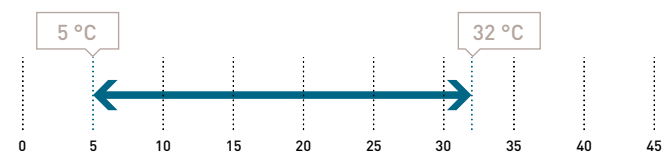

The range at a glance

- Versions: 2-pipes, 2-pipes + electric heater and 4-pipes
- 8 sizes
- Low energy consumption EC fan: 100% controllable via a 0-10 V signal or 3 operating speeds
- Air flow from 91 to 1548 m<sup>3</sup>/h
- Configuration: universal installation units (vertical or horizontal) with or without cabinet
- Left or right water connections
- Many air inlet/outlet configurations
- G2 air filter (G3 as an accessory)

Advantages

- Excellent performances: FCEER and FCCOP up to "A"
- Silent units
- New casing design for an increased robustness
- Harmonious and aesthetic RAL 9003 painted cabinet
- Valves, condensate drain pan and drain pump factory mounted
- 100% factory tested

Accessories and options

- 2 way or 3 way valves
- 4-pipes kit (additional coil)
- Circuit breakers
- Drain pump
- Ecospeed card for EC fans
- Electric heaters (from 500 W to 2500 W)
- Feet with/without grid
- Fuse holders
- G3 filter
- Horizontal or vertical drain guard (with valve)
- Many air inlet/outlet configurations
- Electromechanical sensor for automatic change over
- Modbus communication board for Plologic
- MRC/WRC/BRC: remote controls for Plologic
- Other speeds configuration (standard factory set speeds in technical features table)
- SRC - mini BMS controller
- Suspension kit
- Plologic controller (other electromechanical or electronic control systems also available)
- TControl EASY 3S and TControl POD glass controllers (other electromechanical or electronic control systems also available)

+ SEE PAGE 582 FOR MORE DETAILS ABOUT FAN COIL CONTROLLERS

AC SELECT.

Smart and user-friendly the new air conditioning selection program: <https://acselect.panasonic.eu/>





Technical features

Fan coil comfort EC fan		P-FC10	P-FC20	P-FC30	P-FC40	P-FC50	P-FC60	P-FC70	P-FC80	
		2V/5V/10V <sup>1)</sup>	2V/5V/10V <sup>1)</sup>	2V/6V/10V <sup>1)</sup>	2V/5V/10V <sup>1)</sup>	2V/7V/10V <sup>1)</sup>	2V/7V/10V <sup>1)</sup>	4V/8V/10V <sup>1)</sup>	3V/4,1V/6,4V <sup>1)</sup>	
<b>2-pipes</b>										
Total cooling capacity <sup>2)</sup>	kW	0,59/1,16/1,96	0,61/1,31/2,12	0,67/1,41/1,83	1,34/2,93/4,19	1,34/3,57/4,98	1,98/4,45/5,24	2,55/5,56/6,55	4,59/6,13/8,36	
Sensible capacity <sup>2)</sup>	kW	0,48/1,00/1,76	0,47/1,06/1,72	0,47/1,04/1,34	0,95/2,10/3,00	1,05/2,70/3,70	1,35/3,51/4,02	1,91/4,10/4,96	3,32/4,51/6,28	
Water flow <sup>2)</sup>	l/h	102/200/338	105/226/365	141/336/505	231/505/722	231/615/858	341/767/903	439/958/1128	791/1056/1440	
Water pressure drop <sup>2)3)</sup>	kPa	7,5/25,7/69,5	1,4/4,3/9,3	5,9/21,8/42,9	6,4/24,3/46,3	4,9/28,7/53,9	7,8/35,8/49,0	2,7/12,6/17,5	11,8/19,5/34,2	
Heating capacity <sup>4)</sup>	kW	0,67/1,30/2,31	0,68/1,53/2,52	0,80/1,72/2,66	1,11/2,48/4,46	1,38/3,89/5,19	1,95/4,93/5,82	3,05/5,81/7,17	4,63/6,39/9,28	
Water flow <sup>4)</sup>	l/h	115/224/398	117/264/434	138/296/458	191/427/768	238/670/894	336/849/1002	525/1001/1235	798/1101/1598	
Water pressure drop <sup>2)4)</sup>	kPa	6,5/20,6/59,1	1,7/5,5/12,4	4,1/14,2/30,4	4,8/18,1/51,9	3,8/25,7/44,6	12,2/70,7/97,5	3,9/13,8/20,9	11,9/21,0/41,5	
<b>4-pipes</b>										
Total cooling capacity <sup>2)</sup>	kW	0,51/1,02/1,80	0,57/1,20/2,18	0,75/1,84/2,93	1,03/2,20/3,52	1,17/3,45/4,39	1,69/3,90/4,69	2,44/4,88/6,06	4,44/5,86/9,07	
Sensible capacity <sup>2)</sup>	kW	0,41/0,87/1,60	0,43/0,96/1,76	0,55/1,44/2,28	0,73/1,57/2,58	0,92/2,61/3,28	1,12/3,05/3,63	1,83/3,61/4,53	3,20/4,31/6,84	
Water flow <sup>2)</sup>	l/h	87,8/176/310	98,2/207/376	129/317/505	177/379/606	202/594/756	291/672/808	420/841/1044	765/1009/1562	
Water pressure drop <sup>2)3)</sup>	kPa	5,2/18,3/53,4	1,3/3,8/9,7	4,0/13,7/28,0	9,3/27,8/58,9	2,3/16,2/25,6	4,6/22,0/31,4	3,2/12,3/18,8	18,8/30,6/67,2	
Heating capacity <sup>5)</sup>	kW	0,61/1,13/1,87	0,79/1,33/2,09	1,41/2,01/2,77	1,57/2,49/3,62	2,18/3,34/4,10	1,81/4,05/4,81	3,45/4,67/5,53	5,74/7,99/12,90	
Water flow <sup>5)</sup>	l/h	52,5/97,3/161	68/115/180	121/173/239	135/214/312	188/288/353	156/349/414	297/402/476	494/688/1111	
Water pressure drop <sup>2)5)</sup>	kPa	1,1/2,4/4,8	<1/2,0/4,8	7,9/12,3/18,6	10,9/22,2/41,1	6,5/13,6/19,6	16,1/45,3/57,5	32,2/53,9/72,4	19,2/34,5/83,1	
<b>Sound levels</b>										
Sound power	2-pipes	dB(A)	34/47/60	34/47/60	31/50/59	29/44/52	30/51/57	32/54/58	40/54/59	51/56/64
	4-pipes	dB(A)	34/47/60	34/47/60	31/50/59	29/44/56	30/51/57	32/54/58	40/54/59	51/56/64
Sound pressure <sup>6)</sup>	2-pipes	dB(A)	25/38/51	25/38/51	22/41/50	20/35/43	21/42/48	23/45/49	31/45/50	42/47/55
	4-pipes	dB(A)	25/38/51	25/38/51	22/41/50	20/35/43	21/42/48	23/45/49	31/45/50	42/47/55
NR <sup>6)</sup>	2-pipes		20/33/46	20/33/46	17/36/45	15/30/38	16/37/43	18/40/44	26/40/45	37/42/50
	4-pipes		20/33/46	20/33/46	17/36/45	15/30/38	16/37/43	18/40/44	26/40/45	37/42/50
<b>Ventilation</b>										
Number of fans			1	1	1	2	2	2	3	
Air flow	2-pipes	m <sup>3</sup> /h	108/228/417	98/234/413	119/257/345	170/412/678	203/577/816	245/737/912	350/850/1050	685/927/1398
	4-pipes	m <sup>3</sup> /h	91/199/379	84/200/380	123/297/540	148/298/524	185/587/755	205/668/845	329/798/989	660/884/1548
Filter			G2	G2	G2	G2	G2	G2	G2	
<b>Electrical data</b>										
Power supply	Voltage	V	230	230	230	230	230	230	230	
	Phase		Single phase	Single phase	Single phase	Single phase	Single phase	Single phase	Single phase	
Consumption	Frequency	Hz	50/60	50/60	50/60	50/60	50/60	50/60	50/60	
	2-pipes	W	7/12/41	7/13/41	6/16/42	2/13/43	4/23/46	4/30/54	11/44/77	23/42/108
4-pipes	W	7/12/39	7/13/40	6/14/40	2/11/39	4/23/44	4/28/52	11/43/75	22/41/116	
Electric heater	W		500	500	500/1000	1250	1250/2500	1250/2500	1250/2500	
<b>Water connections</b>										
Connection type			Female gas threaded	Female gas threaded	Female gas threaded	Female gas threaded	Female gas threaded	Female gas threaded	Female gas threaded	
2 or 4-pipes	Cooling	Inch	1/2	1/2	1/2	1/2	1/2	3/4	3/4	
4-pipes	Heating	Inch	1/2	1/2	1/2	1/2	1/2	1/2	1/2	
<b>Dimension</b>										
With cabinet - without feet	HxWxD	mm	477x766x225	477x766x225	477x951x225	477x1136x225	477x1321x225	477x1506x225	575x1319x225	575x1506x225
Without cabinet	HxWxD	mm	430x570x220	430x570x220	430x753x220	430x938x220	430x1122x220	430x1307x220	530x1121x220	530x1316x220
<b>Weight</b>										
With cabinet	2 / 4-pipes	kg	19/20	19/20	22/23	27/29	30/32	35/37	35/37	47/49
Without cabinet	2 / 4-pipes	kg	13/14	13/14	15/16	20/22	22/24	26/28	27/29	38/40

Energy efficiency class<sup>7)</sup>

Fan coil comfort EC fan		FCEER	A to E	C	C	B	A	A	A	B	B
2-pipes	FCEER	A to E	C	C	B	A	A	A	B	B	B
	FCCOP	A to E	D	C	C	B	A	A	B	B	B
4-pipes	FCEER	A to E	C	C	B	A	B	B	B	B	A
	FCCOP	A to E	C	C	B	A	B	B	B	B	A

1) Fan standard factory set speeds (voltage). 2) According to Eurovent standard. Air: 27 °C DB/19 °C WB, chilled water: 7 °C/12 °C. 3) Pressure loss by corresponding nominal flow. 4) According to Eurovent standard. Air: 20 °C, hot water: 45 °C/40 °C. 5) According to Eurovent standard. Air: 20 °C, hot water: 65 °C/55 °C. 6) Informative data, considering an hypothetical sound attenuation of the room and installation of 9 dB(A). 7) According to Eurovent. \* Standard configuration with left hand hydraulic connection. G2 air filter included as standard.

Control options.

Optional wired remote controller for AC fan, 2-pipe and 4-pipe application.  
PAW-FC-RC1



Optional wired remote controller for AC fan 2-pipe application.  
PAW-FC-903AC / PAW-FC-907AC



Optional wired remote controller for EC fan, 2-pipe and 4-pipe application.  
PAW-FC-903EC / PAW-FC-907EC



ErP compliant following COMMISSION REGULATION (EU) 2016/2281.



NEW fan coil wall DC fan – FK1

Fan coil wall units with new stylish design and nanoe™ X (Mark 3).

Cooling capacity: 1,9 to 5,2 kW.

Heating capacity: 2,2 to 5,3 kW.

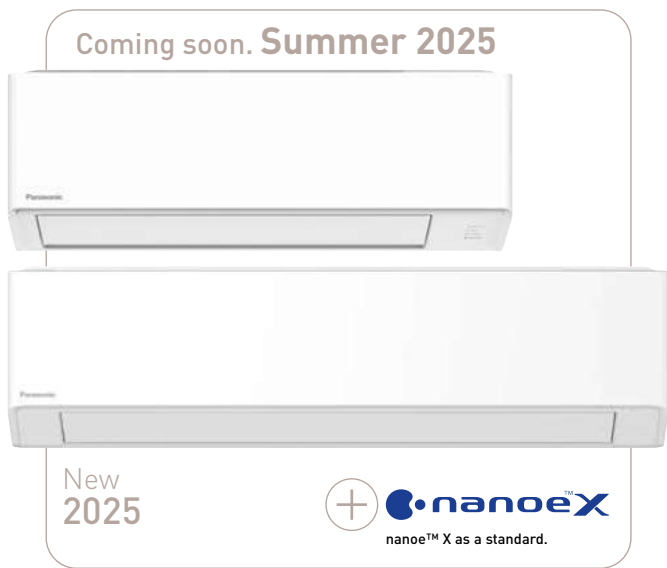

Optional controller. WRC remote control.



Optional controller. SRC - mini BMS controller.



Optional controller. Electronic controller TControl POD glass.



Optional controller. Electronic controller TControl EASY 3S.



Optional controller. Wired remote controller with touch control. PAW-FC-907EC



Optional controller. Wired remote controller. PAW-FC-903EC



Optional controller. CONEX Series, white or black. CZ-RTC6W/BL/BLW2 or CZ-RTC6/BL/BLW2



Optional controller. Wired remote controller with Econavi function. CZ-RTC5B



Optional controller. Infrared remote controller for wall-mounted. CZ-RWS3

The range at a glance

- Versions (2-pipes): with 3 way valve
- 6 sizes
- DC fan for better efficiency and control
- Air flow from 360 to 1045 m³/h
- G1 cleanable air filter

Advantages

- Modern stylish design with flat face and compact size
- Motorized louvers
- Six directional piping outlet
- nanoe™ X (Generator Mark 3) as standard for better indoor air quality
- Quieter operation than AC fan models
- Very easy servicing through a removable front panel
- Cleanable synthetic-type air filter
- Compatibility with a wide range of controllers
- Ideal for commercial and residential applications in combination with Aquarea Heat Pumps

Accessories and options

Modbus communication board for Plogic

SRC - mini BMS controller

WRC: wall-mounted remote control for Plogic

Plogic controller (other electromechanical or electronic control systems also available)

TControl EASY 3S and TControl POD glass controllers (other electromechanical or electronic control systems also available)

CZ-RWS3 - infrared remote controller

CZ-RTC5B - wired remote controller with Econavi function

CZ-RTC6 - CONEX Series wired remote controller

CZ-CENSC1 - Econavi energy saving sensor

Operating limits

Entering water temperature (without glycol).

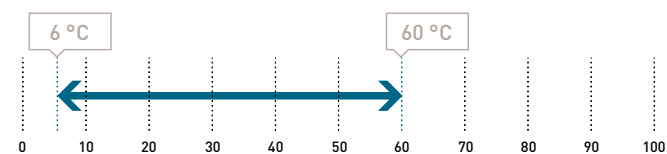

Maximum operating pressure: 10 bar.

Indoor air temperature.

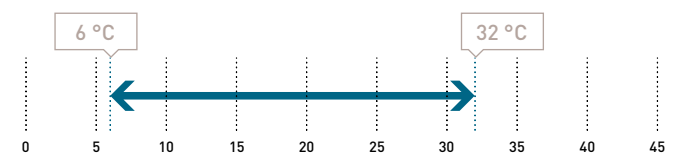

+ SEE PAGE 582 FOR MORE DETAILS ABOUT FAN COIL CONTROLLERS

AC SELECT.

Smart and user-friendly the new air conditioning selection program: <https://acselect.panasonic.eu/>



Technical features

Fan coil wall DC fan - FK1		S-19FK1E	S-24FK1E	S-27FK1E	S-36FK1E	S-45FK1E	S-52FK1E
		H/M/L	H/M/L	H/M/L	H/M/L	H/M/L	H/M/L
<b>2-pipes, with/without 3 way valve</b>							
Total cooling capacity <sup>1)</sup>	kW	1,90/1,65/1,40	2,41/2,17/1,92	2,73/2,51/2,02	3,61/3,11/2,65	4,50/3,78/3,02	5,23/4,63/4,03
Sensible capacity <sup>1)</sup>	kW	1,54/1,35/1,10	1,91/1,71/1,50	2,19/2,00/1,59	2,98/2,52/2,12	3,41/2,84/2,25	4,02/3,51/3,04
Water flow <sup>1)</sup>	l/h	342/295/250	432/389/344	489/449/362	648/556/473	809/680/539	908/830/724
Water pressure drop (coil only)	kPa	8/6/4	13/11/8	17/14/9	30/22/16	42/30/19	56/44/34
Water pressure drop (with 3 way valve) <sup>1)</sup>	kPa	29/23/18	36/29/25	44/39/26	74/57/42	110/80/53	142/112/90
Air flow <sup>1)</sup>	m <sup>3</sup> /h	345/276/230	416/361/324	480/434/343	710/572/462	753/603/488	879/753/637
Input power <sup>1)</sup>	W	12/11/10	14/12/12	16/14/12	26/19/15	22/17/13	29/23/18
Sound pressure Lp <sup>1)2)</sup>	dB(A)	27	26	29	39	35	40
Sound power Lw <sup>1)</sup>	dB(A)	43	42	45	55	51	56
Heating capacity <sup>3)</sup>	kW	2,23/1,92/1,59	2,72/2,39/1,97	3,01/2,64/2,18	4,03/3,48/2,89	5,13/4,21/3,09	5,33/4,72/4,03
Water flow <sup>3)</sup>	l/h	381/329/281	481/417/339	533/463/379	715/614/508	898/740/544	931/827/710
Water pressure drop (coil only)	kPa	10/8/5	16/12/8	20/15/10	36/27/18	52/36/19	56/44/33
Water pressure drop (with 3 way valve) <sup>3)</sup>	kPa	30/24/18	39/31/23	47/36/25	72/60/42	118/82/46	128/97/74
Air flow <sup>3)</sup>	m <sup>3</sup> /h	406/314/253	489/425/343	545/471/379	765/646/517	925/730/511	960/810/672
Input power <sup>3)</sup>	W	13/12/10	15/14/12	17/15/13	28/21/16	32/21/14	35/26/19
Sound pressure Lp <sup>2)3)</sup>	dB(A)	29/27/24	29/26/22	32/28/23	41/36/30	42/36/28	43/39/34
Sound power Lw <sup>3)</sup>	dB(A)	45/43/40	45/42/38	48/44/39	57/52/46	58/52/44	59/55/50
<b>Water Connection</b>							
Connection type		Gas female threaded	Gas female threaded	Gas female threaded	Gas female threaded	Gas female threaded	Gas female threaded
	Inch	1/2	1/2	1/2	1/2	1/2	1/2
nanoe X Generator		Mark 3	Mark 3	Mark 3	Mark 3	Mark 3	Mark 3
<b>Dimensions and weight</b>							
Dimension	H x W x D	mm 295 x 890 x 244	295 x 890 x 244	295 x 890 x 244	295 x 890 x 244	295 x 1060 x 249	295 x 1060 x 249
Weight	kg	12	13	13	13	14	14

Energy efficiency class <sup>1)</sup>

Fan coil wall DC fan - FK1		S-19FK1E		S-24FK1E		S-27FK1E		S-36FK1E		S-45FK1E		S-52FK1E	
2-pipes	FCEER <sup>1)</sup>	A to E	B	B	B	B	B	A	A				
	$\eta_{s,c}$	%	144,2	166,9	172,1	169,3	226,8	213,0					
	FCCOP <sup>3)</sup>	A to E	B	B	B	B	B	B					
	$\eta_{s,h}$	%	160,0	167,0	170,5	173,4	208,5	198,0					

1) According to Eurovent standard. Air: 27 °C DB/19 °C WB, chilled water: 7 °C/12 °C. 2) The sound pressure of the indoor unit shows the value measured of a position of 1 m in front of the main body and 0,8 m below the unit. The sound pressure is measured in accordance with JIS C 9612. 3) According to Eurovent standard. Air: 20 °C, hot water: 45 °C/40 °C.

New fan coil wall.

First Panasonic water fan coil unit integrated with nanoe™ X technology.

Fan coil wall unit with stylish design, ideal for commercial and residential applications in combination with Aquarea Heat Pumps. The units are integrated with nanoe™ X technology to improve protection 24/7 (Generator Mark 3).

Bringing nature's balance indoors.

The new fan coil wall is equipped with nanoe™ X for improved indoor air quality. nanoe™ X, technology with the benefits of hydroxyl radicals.



7 effects of nanoe™ X – Panasonic unique technology.

Capacity to inhibit 5 types of pollutants



Bacteria and viruses



Mould



Allergens



Pollen



Hazardous substances

Deodorises



Odours

Moisturises



Skin and hair



ErP compliant following COMMISSION REGULATION (EU) 2016/2281.

# Sanitary tanks

## Combo tanks.

The best option to combine with Mono-bloc units. DHW tank with buffer tank. Designed for retrofit applications, the DHW tank with a buffer tank is particularly suitable for fast integration on an existing installation. Easy to install, nice looking, high efficiency for DHW production and for heating.

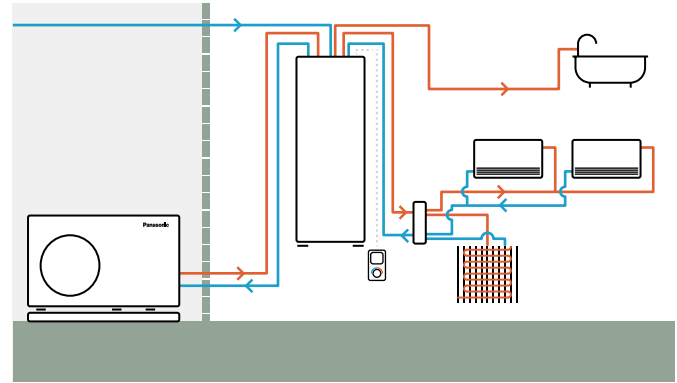

Model	PAW-TD20B8E3-2		PAW-TD23B6E5	
Material	Enamelled		Stainless steel	
Dimension HxWxD	mm	1770x640x690	1750x600x646	
Weight (empty)	kg	150	111	
Water volume	L	185 + 80	230 + 60	
Power supply	V, Phase, Hz	230, 1, 50	230, 1, 50	
		Hot water tank	Buffer tank	
Water volume	L	185	80	230
Max working pressure	MPa (bar)	0,8 (8)	0,6 (6)	1,0 (10)
Pressure test	MPa (bar)	1,2 (12)	0,9 (9)	1,5 (15)
Max working temp	°C	90	90	80
Connections	mm	Ø22	Ø22	Ø22
Material		S 275 JR vitrified	S235 JR	Ø22, copper
Insulation	Material, t=mm	PUR, 50	PUR 40	EN 14521
Heating coil surface	m <sup>2</sup>	2,1	—	EN 14521
Electrical heater	W	3000	—	EN 14521
Energy loss at 65 °C <sup>1)</sup>	kWh/24h	1,3	—	EN 14521
<b>Energy efficiency class (from A+ to F)<sup>2)</sup></b>		<b>B</b>	<b>B</b>	<b>B</b>
Standing loss	W	53	46	52
				29

1) Tested pursuant to EN 12897:2006. 2) EU Regulation 812/2013. \* Enamelled Combo tank is produced by Lapesa. Stainless steel Combo tank is produced by OSO.



## Buffer tanks.

Model	PAW-BTANK50L-2	PAW-BTANK100L	PAW-BTANKG200L	PAW-BTANKG260L
Water volume	L	48	100	194
Energy losses	W	35	55	60
<b>Energy efficiency class (from A+ to F)</b>	<b>B</b>	<b>B</b>	<b>B</b>	<b>C</b>
Material	Stainless steel	Stainless steel	Carbon Steel	Carbon Steel
Dimension (Height / Diameter)	mm	636 / 430	1175 / 430	983 / 620
Net weight	kg	17	28	41
				46

\* Automatic air vent and drain cock are included. Built-in pocket sensor (sensor not included). \*\* 50 and 100 L Buffer Tanks are produced by OSO. 200 and 260 L Buffer Tanks are produced by Lapesa.



## Enamelled tanks.

Type		Enamelled tank				Enamelled 2 coils tank (for bivalent solar + HP)	Square tank
Model		PAW-TA15C1E5	PAW-TA20C1E5STD	PAW-TA30C1E5STD	PAW-TA40C1E5STD	PAW-TA30C2E5STD	PAW-TA20C1E5C
Water volume	L	167	200	290	380	350	200
Maximum water temperature	°C	90	95	95	95	95	95
Dimension (Height / Diameter)	mm	1297/560	1340/610	1800/610	1835/670	1835/670	1550x600x600
Weight / filled with water	kg	88/255	90/280	120/389	191/572	169/519	134/327
Electric heater	kW	—	3,00	3,00	3,00	3,00	—
Power supply	V	—	230	230	230	230	—
Material inside tank		Enamelled	Enamelled	Enamelled	Enamelled	Enamelled	Enamelled
Exchange surface	m <sup>2</sup>	1,8	1,8	2,6	3,8	3,5 / 1,2	1,83
Energy loss at 65 °C <sup>1)</sup>	kWh/24h	1,08	1,37	1,61	1,76	1,76	1,37
3 way valve accessory PAW-3WYVLV-HW, CZ-NV1 or CZ-NV2		Optional	Optional	Optional	Optional	Optional	Built-in 3 way valve
20 m temperature sensor cable included		Yes	Yes	Yes	Yes	Yes	Yes
Energy losses	W	45	57	67	73	73	57
<b>Energy efficiency class (from A+ to F)</b>		<b>B</b>	<b>B</b>	<b>B</b>	<b>B</b>	<b>B</b>	<b>B</b>
Warranty of the inner vessel		2 Years	2 Years	2 Years	2 Years	2 Years	2 Years
Maintenance required		Anode <sup>2)</sup>	Anode <sup>2)</sup>	Anode <sup>2)</sup>	Anode <sup>2)</sup>	Anode <sup>2)</sup>	Anode <sup>2)</sup>

1) Insulated tested under EN12897. 2) Refer to the service manual for further details. \* PAW-TA15C1E5 is produced by Lapesa. All other Enamelled tanks and Square tank are produced by AEmail.



## Stainless steel tanks.

Model		PAW-TD20C1E5-1	PAW-TD30C1E5-1	PAW-TD30C1E5HI-1
Water volume	L	192	284	280
Maximum water temperature	°C	75	75	75
Dimension (Height / Diameter)	mm	1270/595	1750/595	1750 / 595
Weight / filled with water	kg	50/—	61/—	65 / —
Electric heater	kW	1,5	1,5	1,5
Power supply	V	230	230	230
Material inside tank		Stainless steel	Stainless steel	Stainless steel
Exchange surface	m <sup>2</sup>	1,8	1,8	2,35
Energy loss at 65 °C <sup>1)</sup>	kWh/24h	1,01	1,18	1,18
3 way valve accessory PAW-3WYVLV-HW, CZ-NV1 or CZ-NV2		Optional	Optional	Optional
20 m temperature sensor cable included		Yes	Yes	Yes
Energy losses	W	42	49	49
<b>Energy efficiency class (from A+ to F)</b>		<b>A</b>	<b>A</b>	<b>A</b>
Warranty		2 Years	2 Years	2 Years
Maintenance required		No	No	No

1) Insulated tested under EN12897. \* Stainless steel tanks are produced by OSO.

### Accessories for sanitary tanks

<b>PAW-3WYVLV-HW</b>	3 way valve for DHW tanks
<b>CZ-NV1</b>	3 way valve kit to fit inside the hydrokit. H and J Series
<b>CZ-NV2</b>	3 way valve kit to fit inside the hydrokit. K and L Series

### Accessories for sanitary tanks

<b>PAW-EANODE2</b>	Impressed current anode for 200 L Stainless steel tanks
<b>PAW-EANODE3</b>	Impressed current anode for 300 L Stainless steel tanks

# Heat recovery ventilation unit

The heat recovery ventilation unit is design not only to provide a good indoor air quality, but it is also designed to recover heat that would otherwise be lost throughout ventilation. These heat recovery ventilation systems are used to assist in the retention of heat.

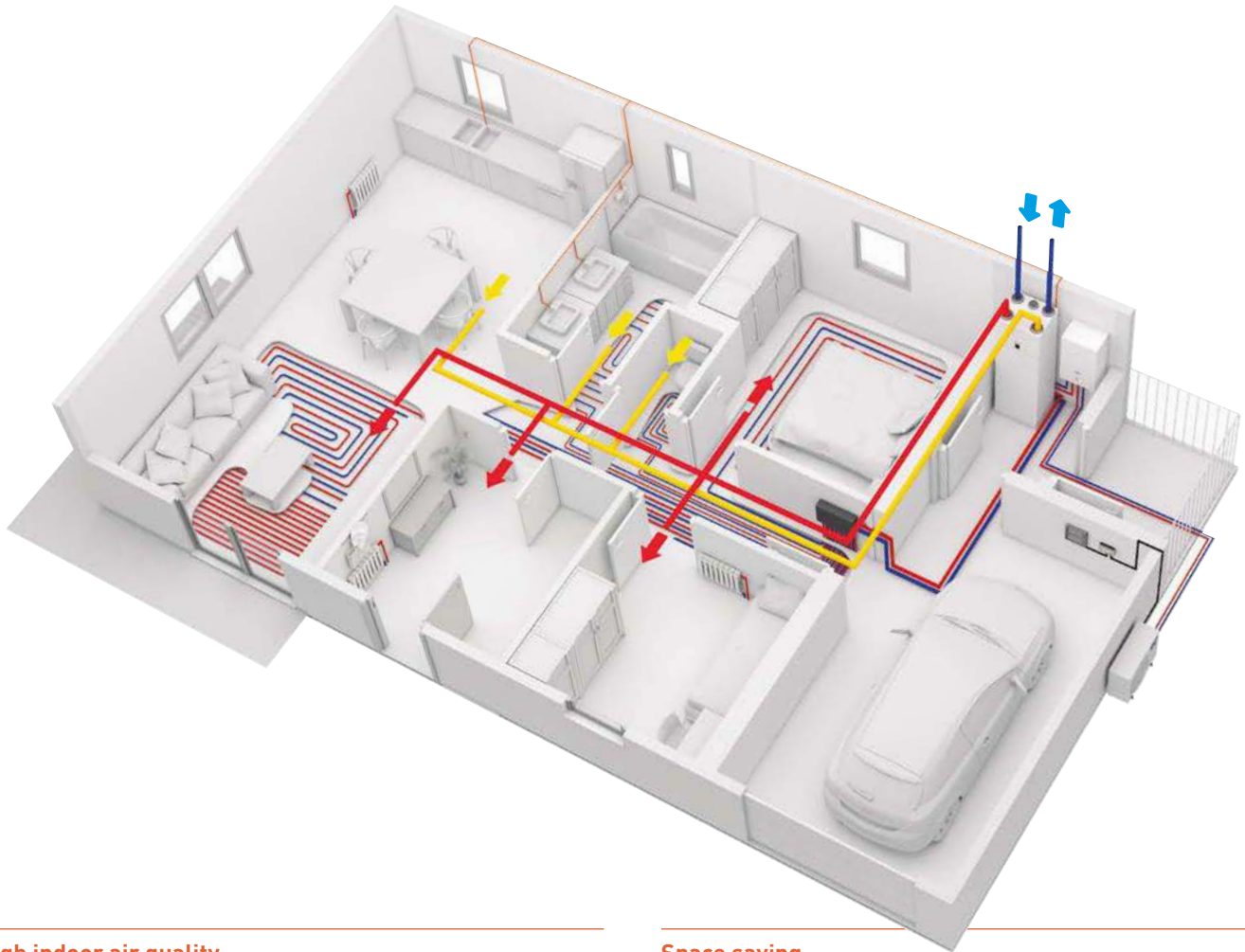

### High indoor air quality

The unit is designed to provide fresh filtered air into the home, while keeping a high thermal comfort.

### Energy saving

Most of the energy from the exhausted air is used to precondition the incoming air, leading to lower heating requirements in the building.

### Space saving

The compact ventilation unit can be installed over the DHW square tank or the Aquarea All in One Compact indoor unit for a space-saving solution.

### Better user interface

The Residential ventilation unit and the Aquarea Heat Pumps can be controlled with one single user-friendly controller.

## AQUAREA

Combine the Residential ventilation unit with Panasonic Aquarea for an space saving and highly efficient solution for heating, cooling, ventilation and DHW.



Heat Recovery Ventilation + Aquarea All in One Compact



Heat Recovery Ventilation + DHW Square Tank + Aquarea Mono-bloc



Heat Recovery Ventilation + DHW Square Tank + Aquarea Bi-bloc

\* The unit can be mounted on a PAW-TA20C1E5C, on a WH-ADC0309J3E5C or installed on the wall (PAW-VEN-WBRK is needed).

## Heat recovery ventilation unit



PAW-A2W-VENTA-R

PAW-A2W-VENTA-L



Model		PAW-A2W-VENTA-R	PAW-A2W-VENTA-L
Nominal air flow rate	m <sup>3</sup> /h		204 @ 50 Pa
Maximum air flow rate	m <sup>3</sup> /h		292 @ 100 Pa
SPF			1,24 @ 204 m <sup>3</sup> /h
Heat exchanger rotor drive type			Variable speed
Exchanger type			Rotating
Heat recovery efficiency			84%
Power supply	V / Hz		230 / 50 / Single phase
Power consumption	W		176
<b>Energy class, basic unit</b>			<b>A</b>
<b>Energy class, unit with local control on demand</b>			<b>A</b>
Noise level	dB(A)		40
Dimension (H x W x D)	mm		450 x 598 x 500
Weight	kg		46
Mounting position			Vertical
Supply side		Right	Left
Duct connections	mm		DN125
Filter class, supply air			F7/ePM1 60%
Filter class, extract air			M5/ePM10 50%
Minimum outdoor temperature	°C		-20

\* Heat recovery efficiency according to EN 13141-7. \*\* Heat recovery ventilation unit is produced by Systemair.

Accessories	
<b>PAW-VEN-FLTKIT</b>	Supply and extract filters kit
<b>PAW-VEN-ACCPCB</b>	Optional PCB for additional functions
<b>PAW-VEN-DPL</b>	HRV touch control panel. White frame (cable must be ordered separately)
<b>PAW-VEN-CBLEXT12</b>	Cable with plug for electrical connection between unit and control panel, type CE and CD (12 m)
<b>PAW-VEN-DIVPLG</b>	Twin plugs for installation of several control panels type CD or CE for one unit

Accessories	
<b>PAW-VEN-DPLBOX</b>	HRV touch control panel wall-mounted kit
<b>PAW-VEN-S-CO2RH-W</b>	CO <sub>2</sub> RH wall-mounted sensor
<b>PAW-VEN-S-CO2-W</b>	CO <sub>2</sub> wall-mounted sensor
<b>PAW-VEN-S-CO2-D</b>	CO <sub>2</sub> duct sensor
<b>PAW-VEN-WBRK</b>	Wall bracket kit for stand-alone installation on the wall
<b>PAW-VEN-HTR06</b>	Electrical duct heater 0,6 kW (includes relay)
<b>PAW-VEN-HTR12</b>	Electrical duct heater 1,2 kW (includes relay)

## Main features of the residential ventilation unit

- Designed for areas up to approximately 140 m<sup>2</sup>
- High energy-efficiency rotary heat exchanger with EC - technology fans
- Moisture transfer function to minimize condensation in supply air during wintertime
- The built in humidity sensor in extract air can be used for demand control
- Control via touch display and Startup Wizard for easy commissioning
- Modbus communication via RS-485
- Option to control an Aquarea H Series onwards heat pump from PAW-A2W-VENTA control panel Modbus gateway (PAW-AZAW-MBS-M or PAW-AW-MBS-H) and PAW-VEN-ACCPCB required

## Control user-friendly interface

All settings and features accessible via a control panel, integrated into the front cover. The option for connecting one or more external control panels is available.

- Color touch screen with a user-friendly interface
- MANUAL and AUTO mode or choose preferred settings from the pre-configured user modes
- If Aquarea H and J Series heat pumps are connected with PAW-A2W-VENTA, the heat pump control options appear on the home screen in a separate tab

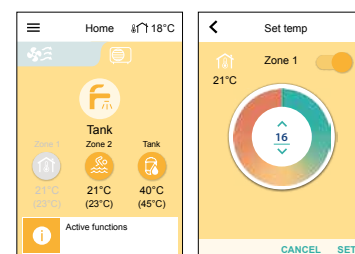
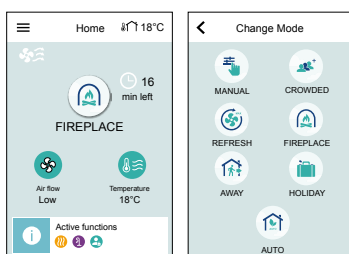

## Aquarea Vent - Counter flow ventilation

Aquarea Vent systems provide a continuous supply of fresh air, ensuring optimal indoor air quality and comfort. Ideal for single-family homes or apartments with low energy requirements, Panasonic's HRV systems combine high-efficiency heat recovery, quiet operation, and advanced air filtration with flexible installation options.



High-efficiency sensible heat recovery.

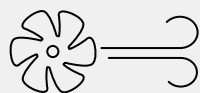

Highly efficient air renewal and filtration, with 80% ePM1 filters.



Integrated air quality, humidity and temperature sensors.



Remote control via Wi-Fi (optional).

### Balanced ventilation

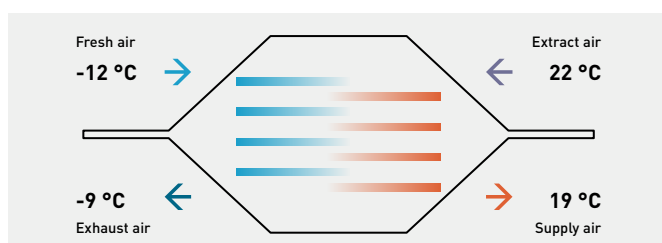

Counter flow ventilation units are equipped with two fans to supply and extract air. A cross-flow heat exchanger recovers the energy contained in the extracted air and transfers it to the supplied air. This significantly reduces the building's energy consumption, while at the same time keeping a good quality of the indoor air.



**Aquarea Vent - Counter flow ventilation units**



PAW-VENTX10-15-20-25Z-1

PAW-VENTX20-30-40-50V-1

PAW-VENTX20-30-40-50H-1



**+** REFER TO PAGE 137 FOR THE COMPLETE LIST OF FILTERS AND ACCESSORIES FOR AIR DISTRIBUTION AND DIFFUSION SYSTEMS

Compact (Horizontal / Vertical mounting)		Air flow	Static pressure	Recovery efficiency	Energy class	Power supply	Power consumption	Sound power LWA	Dimensions / Net weight	Filter class	Duct connection
		Nominal / Max	Nominal / Max			Voltage / Phase / Frequency	Nominal		H x W x D		
		m <sup>3</sup> /h	Pa	%			W	dB(A)	mm / kg		
Universal mounting	<b>P-VEN15XQAZE5</b>	91/130	50/100	87	<b>A</b>	230 V / Single phase / 50 Hz	80	48	255x580x580 /19	ePM1 80%	160
	<b>P-VEN20XQAZE5</b>	147/210	50/100	85	<b>A</b>	230 V / Single phase / 50 Hz	140	51	255x580x580 /19	ePM1 80%	160
Horizontal mounting	<b>P-VEN15XQAEH5</b>	109/155	50/100	86	<b>A</b>	230 V / Single phase / 50 Hz	110	49	260x480x800 /25	ePM1 80%	160
	<b>P-VEN30XQAEH5</b>	210/300	50/100	85	<b>A</b>	230 V / Single phase / 50 Hz	180	50	295x600x795 /30	ePM1 70%	160
	<b>P-VEN35XQAEH5</b>	238/340	50/100	89	<b>A</b>	230 V / Single phase / 50 Hz	350	52	290x650x1150 /38	ePM1 70%	160
	<b>P-VEN45XQAEH5</b>	288/455	50/100	88	<b>A</b>	230 V / Single phase / 50 Hz	420	56	290x1150x1150 /40	ePM1 70%	160
Vertical mounting	<b>P-VEN15XQAVE5</b>	112/170	50/100	86	<b>A</b>	230 V / Single phase / 50 Hz	110	48	510x430x625 /32	ePM1 80%	160
	<b>P-VEN30XQAVE5</b>	210/300	50/100	86	<b>A</b>	230 V / Single phase / 50 Hz	180	50	590x575x785 /38	ePM1 70%	160
	<b>P-VEN40XQAVE5</b>	266/380	50/100	87	<b>A</b>	230 V / Single phase / 50 Hz	350	51	590x735x785 /42	ePM1 70%	160
	<b>P-VEN45XQAVE5</b>	315/450	50/100	86	<b>A</b>	230 V / Single phase / 50 Hz	420	54	590 x 785 x 735 /43	ePM1 70%	160

**Control options (required, to be ordered separately).**

**Wall-mounted control with Modbus.**

PCZ-AHRP0025



- Integrated VOC - CO<sub>2</sub> air quality sensors
- Integrated humidity sensors
- Integrated temperature sensors
- Unit control and settings: Seasonal modes, temperature and fan speed ventilation settings
- Connectivity: Wi-Fi or Modbus

**Wall-mounted control with integrated Wi-Fi for remote control via the Aquarea Home App.**

PCZ-AHRP0026

**Vent PRO.**

From selecting the right ventilation unit to planning the air distribution system and choosing the appropriate components, the Vent PRO guides you through every step to ensure the optimal solution for your project.

Access the tool via the 'Tools' section in the Panasonic Pro Club ([www.panasonicproclub.com](http://www.panasonicproclub.com)).

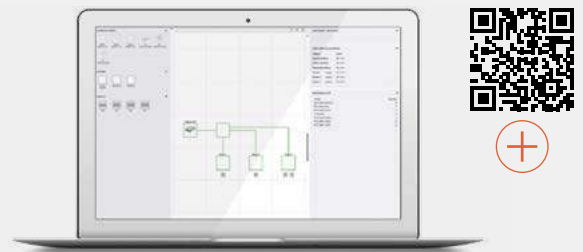

**Remote control with Aquarea Home App.**

\* Requires Wi-Fi control or Home Network Hub PCZ-ESW737.

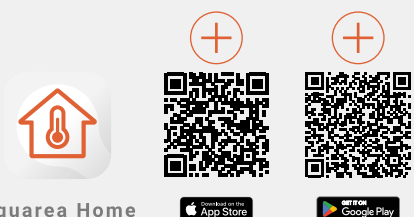

## Aquarea DHW Heat Pumps

Using the natural refrigerant R290, Aquarea DHW Heat Pumps achieve the highest A+ energy efficiency class in their category, significantly reducing energy consumption and CO<sub>2</sub> emissions compared to electric heaters. The range includes wall-mounted and floor-standing models with tank capacities from 100 to 260 litres, designed to meet different household needs.



A+

**High performance and  
A+ energy rank.**

-7°C  
+43°C

**Wide operation  
range.**



**Saves maintenance time  
with dry check for  
magnesium anode.**



**User-friendly  
touch control.**

### Wall mounted version.

- 100 L and 150 L DHW tank
- Wide operating range from -5 to +43 °C.
- 60 °C hot water only with heat pump



### Floor standing version.

- 200 L and 260 L DHW tank
- Version with additional coil for operation with other heat sources such as PV panels
- Wide operating range from -7 to +43 °C
- 65 °C hot water only with heat pump



## Aquarea DHW Heat Pumps



Type	Wall-mounted			Floor-standing			
	Reference	P-DHW100AE5	P-DHW150AE5	P-DHW200AE5	P-DHW200CAE5	P-DHW260AE5	P-DHW260CAE5
<b>Performance according to EN 16147</b>							
Reference hot water temperature ( $T_{ref}$ )	°C	55	55	55	55	55	55
Heating up time (A +14 °C / W 55 °C)	h:m	5:44	8:46	7:22	7:18	9:36	9:45
Heating up time (A +7 °C / W 55 °C)	h:m	6:44	10:08	7:01	7:08	10:21	10:32
Heating up time (A +2 °C / W 55 °C)	h:m	9:53	12:17	11:32	11:21	14:31	14:42
DHW tank ERP efficiency average / warm / cold	A+ to F	A+/A++/A	A+/A++/A	A+/A++/A	A+/A++/A	A+/A++/A	A+/A++/A
DHW tank ERP average climate $\eta$ / COPdHW	$\eta_{wh} \%$ / COPdHW	117/2,80	117/2,80	149/3,58	148/3,53	150/3,64	148/3,59
DHW tank ERP warm climate $\eta$ / COPdHW	$\eta_{wh} \%$ / COPdHW	132/3,20	132/3,34	159/3,81	158/3,78	162/3,90	158/3,84
DHW tank ERP cold climate $\eta$ / COPdHW	$\eta_{wh} \%$ / COPdHW	92/2,20	102/2,40	110/2,67	108/2,61	120/2,91	117/2,85
Indoor sound power <sup>1)</sup>	dB(A)	45	45	50	50	50	50
Outdoor sound power <sup>1)</sup>	dB(A)	50	50	50	50	50	50
Load profile		M	L	L	L	XL	XL
Water volume	L	98	143	202	194	260	251
Water volume of mixed water at 40 °C / V40	L	133	172	352	359	262	275
Additional coil exchanger connection		—	—	—	1" M	—	1" M
Additional coil surface	m <sup>2</sup>	—	—	—	1,05	—	1,05
Anticorrosion system	Anode	Magnesium	Magnesium	Magnesium	Magnesium	Magnesium	Magnesium
Anti-legionella cycle		Yes	Yes	Yes	Yes	Yes	Yes
Maximum working pressure - storage tank	Mpa (bar)	0,8 (8)	0,8 (8)	0,8 (8)	0,8 (8)	0,8 (8)	0,8 (8)
Dimension (HxWxD)	mm	1351x520x541	1682x520x541	1621x705x694	1621x705x694	1911x705x694	1911x705x694
Empty weight	kg	56	65	100	115	111	126
Heat pump air intake temperature range	°C	-5 ~ +43	-5 ~ +43	-7 ~ +43	-7 ~ +43	-7 ~ +43	-7 ~ +43
Maximum water temperature / with heater	°C	60/65	60/65	65/75	65/75	65/75	65/75
Refrigerant charge (R290)	kg	0,15	0,15	0,15	0,15	0,15	0,15
Power supply / frequency	V / Hz	230/50	230/50	230/50	230/50	230/50	230/50
Total maximum power consumption	W	1726	1726	1970	1970	1970	1970
Heat pump maximum power consumption	W	276	276	470	470	470	470
Electric heating element power consumption	W	1500	1500	1500	1500	1500	1500
Nominal air flow	m <sup>3</sup> /h	235	235	330	330	330	330
External pressure nominal / maximum	Pa	42/220	42/220	88/220	88/220	88/220	88/220
Duct diameter	mm	125	125	160	160	160	160

1) According to EN12102.



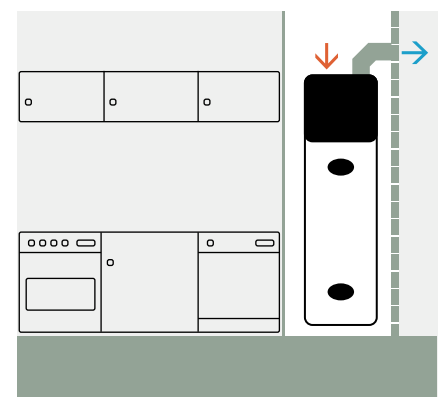
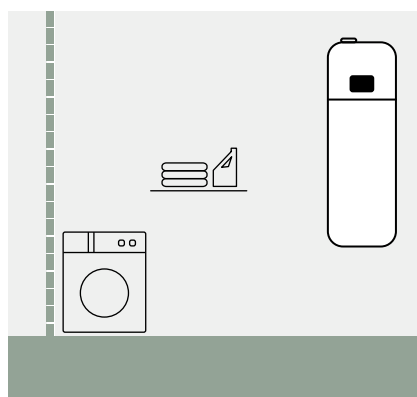

## Space-saving design

Side air ducts for easy installation in rooms as small as 2 metres high.



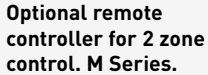
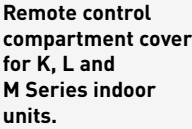

# Accessories and control

## Controls and room thermostats

					
<p><b>Remote controller with Wi-Fi adapter (required for stand-alone outdoor units). M Series. Includes 10 m extension cable.</b></p>	<p><b>Optional remote controller for 2 zone control. K and L Series.</b></p>	<p><b>Optional remote controller for 2 zone control. M Series.</b></p>	<p><b>Remote control compartment cover for K, L and M Series indoor units.</b></p>	<p><b>Wired LCD room thermostat with weekly timer.</b></p>	<p><b>Wireless LCD room thermostat with weekly timer.</b></p>
CZ-RTW2TAW1C	CZ-RTW1	CZ-RTW2	PAW-A2W-COV-KL	PAW-A2W-RTWIRED	PAW-A2W-RTWIRELESS

## Cascade solutions



		
<p><b>Cascade manager for Aquarea Heat Pumps. Cascade up to 10 Aquarea Heat Pumps.</b></p>	<p><b>Aquarea Cascade Edge (manager) for Aquarea Heat Pumps with P-Smart Edge control and monitoring software. Cascade up to 4 units.</b></p>	<p><b>Aquarea Cascade Edge (manager) for Aquarea Heat Pumps with P-Smart Edge control and monitoring software. Cascade up to 10 units.</b></p>
PAW-A2W-CMH-3	PAW-A2W-CME4	PAW-A2W-CME10

## PCBs for additional functions

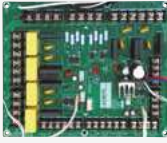

## Indoor unit accessories

	<p><b>PCB for advanced functions. K and L Series.</b></p>	<p><b>Wall bracket to mount the All in One 120 L on the wall.</b></p>
<p><b>PCB for advanced functions. H and J Series.</b></p>	CZ-NS5P	* Check availability.
<p><b>PCB for advanced functions. M Series All in One and Bi-bloc.</b></p>	<p><b>PCB for advanced functions. M Series control module.</b></p>	CZ-NW1
CZ-NS6P	CZ-NS7P	

## Outdoor unit accessories

	<p><b>Base pan heater. H and J Series and K Series 9 kW (2 fans model), 12 and 16 kW.</b></p>	
<p><b>Base pan heater for Bi-bloc 3 and 5 kW (except L Series) and K Series 7 and 9 kW (1 fan model).</b></p>	CZ-NE3P	<p><b>Outdoor base ground support for noise and vibration absorption.</b> Dimension (HxWxD): 600 x 95 x 130 mm Safe working load: 500 kg</p>
<p><b>Base pan heater. L Series 5, 7 and 9 kW and M Series.</b></p>	<p><b>Base pan heater. M Series 20, 25, 30 kW.</b></p>	PAW-GRDBSE20
CZ-NE4P	CZ-NE5P	



**Black ground stand for outdoor unit with 940 mm wide condenser water tray.**

PAW-GRDSTD940



**Black ground stand for outdoor unit with 1100 mm wide condenser water tray.**

PAW-GRDSTD1100

**Electrical heater foil for the ground stand with 940 mm wide condenser water tray.**

PAW-GRDSTDHTR940

**Electrical heater foil for the ground stand with 1100 mm wide condenser water tray.**

PAW-GRDSTDHTR1100

**Hydraulic accessories**

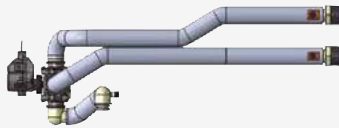

**3 way valve kit to fit inside the hydrokit. H and J Series.**

CZ-NV1

**3 way valve kit to fit inside the hydrokit. K and L Series.**

CZ-NV2

**3 way valve kit to fit inside the hydrokit. M Series.**

CZ-NV3



**3 way valve for DHW tanks.**

PAW-3WYVLV-HW



**1 antifreeze valve.**  
It is required to order 2 valves per system. For 9, 12 and 16 kW.

PAW-A2W-AFVLV-1

**1 antifreeze valve 1 1/2".**  
It is required to order 2 valves per system. For 20, 25 and 30 kW.

PAW-A2W-AFVLV-112



**Optional magnet for the water filter in H Series models.**

PAW-A2W-MGTFILTER

**Connectivity**



**Optional Wi-Fi or WLAN adapter for smart control via Panasonic Comfort Cloud and/or remote maintenance via Aquarea Service Cloud.**

CZ-TAW1C

**10 m extension cable for CZ-TAW1C.**

CZ-TAW1-CBL

**Aquarea Home Network Hub.**

PCZ-ESW737



**External meter gateway for K Series onwards.**

PAW-A2W-EXTMETER



**Modbus PCB for Big Aquarea T-CAP M Series (installed inside the WH-CME8L).**

CZ-NSMB



**Modbus interface for H Series onwards (Airzone).**

PAW-AZAW-MBS-M



**Modbus interface (Intesis). H and J Series.**

PAW-AW-MBS-H



**KNX interface for H Series onwards (Airzone).**





PAW-AZAW-KNX-1



**KNX interface for H Series onwards (Intesis).**

PAW-AW-KNX-H



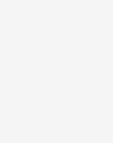

Sensors for Aquarea H Series onwards

 <p><b>Outdoor ambient sensor.</b> ----- PAW-A2W-TSOD</p>	 <p><b>Zone room sensor.</b> ----- PAW-A2W-TSRT</p>	 <p><b>Zone water sensor.</b> ----- PAW-A2W-TSHC</p>
 <p><b>Solar sensor.</b> ----- PAW-A2W-TSSO</p>	 <p><b>Buffer tank sensor (for H and J Series, PAW-A2W-TSHC required if optional PCB is used.)</b> ----- PAW-A2W-TSBU</p>	 <p><b>In-line heater sensor for the control module M Series.</b> ----- PAW-A2W-TSBH</p>

tado° room control and smart energy management









tado° Room control sets with Heat Pump Optimizer X

 <p><b>Set of tado° Heat Pump Optimizer X and 1x Smart Radiator Thermostat X.</b> ----- KIT-TSRTXHPOXE</p>	 <p><b>Set of tado° Heat Pump Optimizer X and 4x tado° Smart Radiator Thermostat X.</b> ----- KIT-TSRTX4HP0XE</p>	 <p><b>Set of tado° Heat Pump Optimizer X and 1x Smart Thermostat X.</b> ----- KIT-TSTXHPOXE</p>	 <p><b>Set of tado° Heat Pump Optimizer X and 1x Smart Thermostat X and 2x Smart Radiator Thermostat X.</b> ----- KIT-TSTXSRTX2HP0XE</p>
--	---	---	--

tado° Room control sets with Bridge X



 <p><b>tado° Smart Radiator Thermostat X with Bridge X.</b> ----- PAW-TSRTXB</p>	 <p><b>tado° Smart Thermostat X with Bridge X.</b> ----- PAW-TSTXB</p>	 <p><b>Set of 1x Smart Thermostat X, 2x Smart Radiator Thermostat X and 1x Bridge X.</b> ----- PAW-TSTXSRTX2B</p>
---	---	--

tado° X devices

 <p><b>tado° Heat Pump Optimizer X (with Europlug).</b> ----- PAW-THPOXE</p>	 <p><b>tado° Smart Thermostat X.</b> ----- PAW-TSTX</p>	 <p><b>tado° Wireless Temperature Sensor X.</b> ----- PAW-TWTSX</p>	 <p><b>tado° Smart Radiator Thermostat X.</b> ----- PAW-TSRTX</p>	 <p><b>4x tado° Smart Radiator Thermostat X.</b> ----- PAW-TSRTX4</p>	 <p><b>tado° Bridge X.</b> ----- PAW-TBX</p>
---	--	--	---	--	---

**Aquarea Air Smart fan coil floor standing accessories**

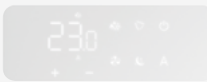
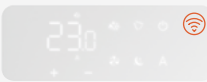
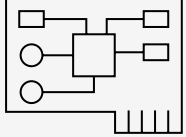

**Control accessories**

 <p><b>Wall-mounted control with Modbus for Aquarea Air Smart fan coils.</b></p> <p>----- PCZ-EEB749</p>	 <p><b>Wall-mounted control with Integrated Wi-Fi for Aquarea Air Smart fan coils.</b></p> <p>----- PCZ-EFB749</p>	 <p><b>Wall-mounted control PCB for Aquarea Air Smart fan coil floor standing.</b></p> <p>----- PCZ-ESE845</p>	 <p><b>On-board display with Modbus for Aquarea Air Smart fan coil floor standing.</b></p> <p>----- PCZ-ECA844</p>	 <p><b>On-board display with integrated Wi-Fi for Aquarea Air Smart fan coil floor standing.</b></p> <p>----- PCZ-EWA844</p>	 <p><b>PCB for analog control (0-10V) for Aquarea Air Smart fan coils Floor standing.</b></p> <p>----- PCZ-B10842</p>
---	---	---	--	---	--

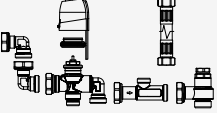
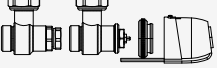

**Hydraulic accessories**

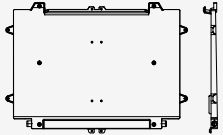
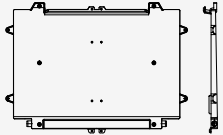
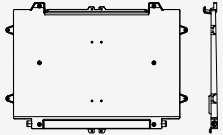
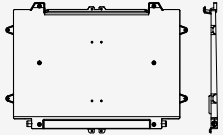
 <p><b>Motorised 3 way valve for Aquarea Air floor standing.</b></p> <p>----- PCZ-V30720</p>	 <p><b>Motorised 2 way valve for Aquarea Air floor standing, wall-mounted 40 and ducted.</b></p> <p>----- PCZ-V20139</p>
---	---

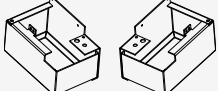





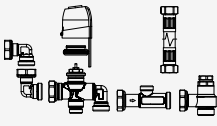
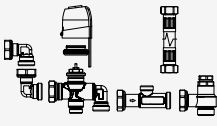
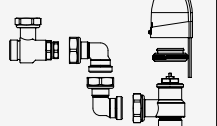
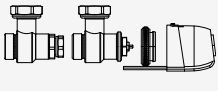

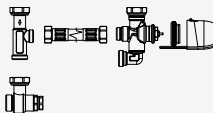

**Installation accessories**

 <p><b>Condensate drip tray for horizontal installation of the Aquarea Air Smart fan coil floor standing 10.</b></p> <p>----- PCZ-GB0520</p>	 <p><b>Condensate drip tray for horizontal installation of the Aquarea Air Smart fan coil floor standing 20.</b></p> <p>----- PCZ-GB0521</p>	 <p><b>Condensate drip tray for horizontal installation of the Aquarea Air Smart fan coil floor standing 30.</b></p> <p>----- PCZ-GB0522</p>	 <p><b>Condensate drip tray for horizontal installation of the Aquarea Air Smart fan coil floor standing 35.</b></p> <p>----- PCZ-GB0523</p>	 <p><b>Set of 2 legs to protect water pipes for Aquarea Air floor standing.</b></p> <p>----- PCZ-LC0158</p>	 <p><b>Set of 2 legs to anchor the Aquarea Air floor standing to the floor.</b></p> <p>----- PCZ-LC0606</p>
<p><b>Condensate drip tray for horizontal installation of the Aquarea Air Smart fan coil floor standing 40.</b></p> <p>----- PCZ-GB0524</p>					

**Aquarea Air Smart fan coil wall-mounted accessories**

Control accessories		Hydraulic accessories			
 <p><b>Wall-mounted control with Modbus for Aquarea Air Smart fan coils.</b></p> <p>----- PCZ-EEB749</p>	 <p><b>Wall-mounted control with Integrated Wi-Fi for Aquarea Air Smart fan coils.</b></p> <p>----- PCZ-EFB749</p>	 <p><b>Motorised 3 way valve for Aquarea Air wall-mounted 10, 15 and 20.</b></p> <p>----- PCZ-V30688</p>	 <p><b>Motorised 3 way valve for Aquarea Air wall-mounted 40.</b></p> <p>----- PCZ-V30718</p>	 <p><b>Motorised 2 way valve for Aquarea Air wall-mounted 10, 15 and 20.</b></p> <p>----- PCZ-V20687</p>	 <p><b>Motorised 2 way valve for Aquarea Air floor standing, wall-mounted 40 and ducted.</b></p> <p>----- PCZ-V20139</p>

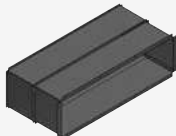







Aquarea Air Smart fan coil ducted thin accessories

Control accessories			Hydraulic accessories				
 <p><b>Wall-mounted control with Modbus for Aquarea Air Smart fan coils.</b></p> <p>-----</p> <p>PCZ-EEB749</p>		 <p><b>Wall-mounted control with Integrated Wi-Fi for Aquarea Air Smart fan coils.</b></p> <p>-----</p> <p>PCZ-EFB749</p>		 <p><b>Motorised 3 way valve for Aquarea Air ducted.</b></p> <p>-----</p> <p>PCZ-V30361</p>		 <p><b>Motorised 2 way valve for Aquarea Air floor standing, wall-mounted 40 and ducted.</b></p> <p>-----</p> <p>PCZ-V20139</p>	
Replacement filter kit	Delivery plates	Return plenum	90° shooting plenum	Telescopic kit	Grille for telescopic kit		
 <p><b>Replacement recirculation filter kit. For P-FSN20 and P-FTN15.</b></p> <p>-----</p> <p>PCZ-AHRD0491</p>	 <p><b>Delivery plate with 2 circular inlets DN 160 mm. For P-FTN15.</b></p> <p>-----</p> <p>PCZ-AHRD0561</p>	 <p><b>Return plenum with 2 circular inlets DN 160 mm. For P-FTN15.</b></p> <p>-----</p> <p>PCZ-AHRD0566</p>	 <p><b>90° shooting plenum. For P-FTN15.</b></p> <p>-----</p> <p>PCZ-AHRD0576</p>	 <p><b>Telescopic kit for rear or directly coupled suction. 153 mm - 270 mm. For P-FTN15.</b></p> <p>-----</p> <p>PCZ-AHRD0581</p>	 <p><b>Grille for telescopic kit for rear intake. For P-FTN15.</b></p> <p>-----</p> <p>PCZ-AHRD0586</p>		
<p><b>Replacement recirculation filter kit. For P-FSN25, P-FTN20, P-FSQ30 and P-FTQ30.</b></p> <p>-----</p> <p>PCZ-AHRD0492</p>	<p><b>Delivery plate with 3 circular inlets DN 160 mm. For P-FTN20.</b></p> <p>-----</p> <p>PCZ-AHRD0562</p>	<p><b>Return plenum with 3 circular inlets DN 160 mm. For P-FTN20.</b></p> <p>-----</p> <p>PCZ-AHRD0567</p>	<p><b>90° shooting plenum. For P-FTN20 and P-FTQ30.</b></p> <p>-----</p> <p>PCZ-AHRD0577</p>	<p><b>Telescopic kit for rear or directly coupled suction. 153 mm - 270 mm. For P-FTN20.</b></p> <p>-----</p> <p>PCZ-AHRD0582</p>	<p><b>Grille for telescopic kit for rear intake. For P-FTN20.</b></p> <p>-----</p> <p>PCZ-AHRD0587</p>		
<p><b>Replacement recirculation filter kit. For P-FSN35, P-FTN25, P-FSQ45 and P-FTQ45.</b></p> <p>-----</p> <p>PCZ-AHRD0493</p>	<p><b>Delivery plate with 4 circular inlets DN 160 mm. For P-FTN25.</b></p> <p>-----</p> <p>PCZ-AHRD0563</p>	<p><b>Return plenum with 4 circular inlets DN 160 mm. For P-FTN25.</b></p> <p>-----</p> <p>PCZ-AHRD0568</p>	<p><b>90° shooting plenum. For P-FTN25 and P-FTQ45.</b></p> <p>-----</p> <p>PCZ-AHRD0578</p>	<p><b>Telescopic kit for rear or directly coupled suction. 153 mm - 270 mm. For P-FTN25.</b></p> <p>-----</p> <p>PCZ-AHRD0583</p>	<p><b>Grille for telescopic kit for rear intake. For P-FTN25.</b></p> <p>-----</p> <p>PCZ-AHRD0588</p>		
<p><b>Replacement recirculation filter kit. For P-FSN45, P-FTN35, P-FSQ60 and P-FTQ60.</b></p> <p>-----</p> <p>PCZ-AHRD0494</p>	<p><b>Delivery plate with 6 circular inlets DN 160 mm. For P-FTN35.</b></p> <p>-----</p> <p>PCZ-AHRD0564</p>	<p><b>Return plenum with 6 circular inlets DN 160 mm. For P-FTN35.</b></p> <p>-----</p> <p>PCZ-AHRD0569</p>	<p><b>90° shooting plenum. For P-FTN35 and P-FTQ60.</b></p> <p>-----</p> <p>PCZ-AHRD0579</p>	<p><b>Telescopic kit for rear or directly coupled suction. 153 mm - 270 mm. For P-FTN35.</b></p> <p>-----</p> <p>PCZ-AHRD0584</p>	<p><b>Grille for telescopic kit for rear intake. For P-FTN35.</b></p> <p>-----</p> <p>PCZ-AHRD0589</p>		
<p><b>Replacement recirculation filter kit. For P-FSN55, P-FTN45, P-FSQ75 and P-FTQ65.</b></p> <p>-----</p> <p>PCZ-AHRD0495</p>	<p><b>Delivery plate with 7 circular inlets DN 160 mm. For P-FTN45.</b></p> <p>-----</p> <p>PCZ-AHRD0565</p>	<p><b>Return plenum with 7 circular inlets DN 160 mm. For P-FTN45.</b></p> <p>-----</p> <p>PCZ-AHRD0570</p>	<p><b>90° shooting plenum. For P-FTN45 and P-FTQ65.</b></p> <p>-----</p> <p>PCZ-AHRD0580</p>	<p><b>Telescopic kit for rear or directly coupled suction. 153 mm - 270 mm. For P-FTN45.</b></p> <p>-----</p> <p>PCZ-AHRD0585</p>	<p><b>Grille for telescopic kit for rear intake. For P-FTN45.</b></p> <p>-----</p> <p>PCZ-AHRD0590</p>		

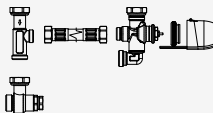
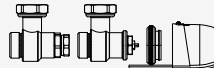



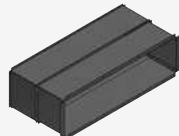





Outdoor air kit	Ducting plate outdoor air kit	90° plenum for outdoor air kit with damper	Telescopic kit for outdoor air kit	Grille for telescopic kit for outdoor air kit
 <p>Plenum kit for external air connection with damper for room recirculation. For P-FTN15.</p> <p>----- PCZ-AHRD0571</p>	 <p>Ducting plate plenum kit for outdoor air connection with damper. For P-FTN15.</p> <p>----- PCZ-AHRD0611</p>	 <p>90° plenum for outdoor air kit with damper. For P-FTN15.</p> <p>----- PCZ-AHRD0616</p>	 <p>Telescopic kit. For plenum for outdoor air kit with damper. For P-FTN15.</p> <p>----- PCZ-AHRD0621</p>	 <p>Grille for telescopic kit. For plenum for outdoor air kit with damper. For P-FTN15.</p> <p>----- PCZ-AHRD0626</p>
<p>Plenum kit for external air connection with damper for room recirculation. For P-FTN20 and P-FTQ30.</p> <p>----- PCZ-AHRD0572</p>	<p>Ducting plate plenum kit for outdoor air connection with damper. For P-FTN20 and P-FTQ30.</p> <p>----- PCZ-AHRD0612</p>	<p>90° plenum for outdoor air kit with damper. For P-FTN20 and P-FTQ30.</p> <p>----- PCZ-AHRD0617</p>	<p>Telescopic kit. For plenum for outdoor air kit with damper. For P-FTN20 and P-FTQ30.</p> <p>----- PCZ-AHRD0622</p>	<p>Grille for telescopic kit. For plenum for outdoor air kit with damper. For P-FTN20 and P-FTQ30.</p> <p>----- PCZ-AHRD0627</p>
<p>Plenum kit for external air connection with damper for room recirculation. For P-FTN25 and P-FTQ45.</p> <p>----- PCZ-AHRD0573</p>	<p>Ducting plate plenum kit for outdoor air connection with damper. For P-FTN25 and P-FTQ45.</p> <p>----- PCZ-AHRD0613</p>	<p>90° plenum for outdoor air kit with damper. For P-FTN25 and P-FTQ45.</p> <p>----- PCZ-AHRD0618</p>	<p>Telescopic kit. For plenum for outdoor air kit with damper. For P-FTN25 and P-FTQ45.</p> <p>----- PCZ-AHRD0623</p>	<p>Grille for telescopic kit. For plenum for outdoor air kit with damper. For P-FTN25 and P-FTQ45.</p> <p>----- PCZ-AHRD0628</p>
<p>Plenum kit for external air connection with damper for room recirculation. For P-FTN35 and P-FTQ60.</p> <p>----- PCZ-AHRD0574</p>	<p>Ducting plate plenum kit for outdoor air connection with damper. For P-FTN35 and P-FTQ60.</p> <p>----- PCZ-AHRD0614</p>	<p>90° plenum for outdoor air kit with damper. For P-FTN35 and P-FTQ60.</p> <p>----- PCZ-AHRD0619</p>	<p>Telescopic kit. For plenum for outdoor air kit with damper. For P-FTN35 and P-FTQ60.</p> <p>----- PCZ-AHRD0624</p>	<p>Grille for telescopic kit. For plenum for outdoor air kit with damper. For P-FTN35 and P-FTQ60.</p> <p>----- PCZ-AHRD0629</p>
<p>Plenum kit for external air connection with damper for room recirculation. For P-FTN45 and P-FTQ65.</p> <p>----- PCZ-AHRD0575</p>	<p>Ducting plate plenum kit for outdoor air connection with damper. For P-FTN45 and P-FTQ65.</p> <p>----- PCZ-AHRD0615</p>	<p>90° plenum for outdoor air kit with damper. For P-FTN45 and P-FTQ65.</p> <p>----- PCZ-AHRD0620</p>	<p>Telescopic kit. For plenum for outdoor air kit with damper. For P-FTN45 and P-FTQ65.</p> <p>----- PCZ-AHRD0625</p>	<p>Grille for telescopic kit. For plenum for outdoor air kit with damper. For P-FTN45 and P-FTQ65.</p> <p>----- PCZ-AHRD0630</p>



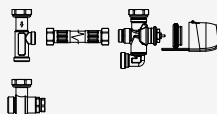

Aquarea Air Smart fan coil ducted accessories

Control accessories			Hydraulic accessories				
 <p><b>Wall-mounted control with Modbus for Aquarea Air Smart fan coils.</b></p> <p>-----</p> <p>PCZ-EEB749</p>		 <p><b>Wall-mounted control with Integrated Wi-Fi for Aquarea Air Smart fan coils.</b></p> <p>-----</p> <p>PCZ-EFB749</p>		 <p><b>Motorised 3 way valve for Aquarea Air ducted.</b></p> <p>-----</p> <p>PCZ-V30361</p>		 <p><b>Motorised 2 way valve for Aquarea Air floor standing, wall-mounted 40 and ducted.</b></p> <p>-----</p> <p>PCZ-V20139</p>	
Replacement filter kit	Delivery plates	Return plenum	90° shooting plenum	Telescopic kit	Grille for telescopic kit		
 <p><b>Replacement recirculation filter kit. For P-FSN20 and P-FTN15.</b></p> <p>-----</p> <p>PCZ-AHRD0491</p>	 <p><b>Delivery plate with 2 circular inlets DN 160 mm. For P-FSN20.</b></p> <p>-----</p> <p>PCZ-AHRD0431</p>	 <p><b>Return plenum with 2 circular inlets DN 160 mm. For P-FSN20.</b></p> <p>-----</p> <p>PCZ-AHRD0461</p>	 <p><b>90° shooting plenum. For P-FSN20.</b></p> <p>-----</p> <p>PCZ-AHRD0521</p>	 <p><b>Telescopic kit for rear or directly coupled suction. 153 mm - 270 mm. For P-FSN20.</b></p> <p>-----</p> <p>PCZ-AHRD0531</p>	 <p><b>Grille for telescopic kit for rear intake. For P-FSN20.</b></p> <p>-----</p> <p>PCZ-AHRD0541</p>		
<p><b>Replacement recirculation filter kit. For P-FSN25, P-FTN20, P-FSQ30 and P-FTQ30.</b></p> <p>-----</p> <p>PCZ-AHRD0492</p>	<p><b>Delivery plate with 3 circular inlets DN 160 mm. For P-FSN25.</b></p> <p>-----</p> <p>PCZ-AHRD0432</p>	<p><b>Return plenum with 3 circular inlets DN 160 mm. For P-FSN25.</b></p> <p>-----</p> <p>PCZ-AHRD0462</p>	<p><b>90° shooting plenum. For P-FSN25 and P-FSQ30.</b></p> <p>-----</p> <p>PCZ-AHRD0522</p>	<p><b>Telescopic kit for rear or directly coupled suction. 153 mm - 270 mm. For P-FSN25.</b></p> <p>-----</p> <p>PCZ-AHRD0532</p>	<p><b>Grille for telescopic kit for rear intake. For P-FSN25.</b></p> <p>-----</p> <p>PCZ-AHRD0542</p>		
<p><b>Replacement recirculation filter kit. For P-FSN35, P-FTN25, P-FSQ45 and P-FTQ45.</b></p> <p>-----</p> <p>PCZ-AHRD0493</p>	<p><b>Delivery plate with 4 circular inlets DN 160 mm. For P-FSN35.</b></p> <p>-----</p> <p>PCZ-AHRD0433</p>	<p><b>Return plenum with 4 circular inlets DN 160 mm. For P-FSN35.</b></p> <p>-----</p> <p>PCZ-AHRD0463</p>	<p><b>90° shooting plenum. For P-FSN35 and P-FSQ45.</b></p> <p>-----</p> <p>PCZ-AHRD0523</p>	<p><b>Telescopic kit for rear or directly coupled suction. 153 mm - 270 mm. For P-FSN35.</b></p> <p>-----</p> <p>PCZ-AHRD0533</p>	<p><b>Grille for telescopic kit for rear intake. For P-FSN35.</b></p> <p>-----</p> <p>PCZ-AHRD0543</p>		
<p><b>Replacement recirculation filter kit. For P-FSN45, P-FTN35, P-FSQ60 and P-FTQ60.</b></p> <p>-----</p> <p>PCZ-AHRD0494</p>	<p><b>Delivery plate with 6 circular inlets DN 160 mm. For P-FSN45.</b></p> <p>-----</p> <p>PCZ-AHRD0434</p>	<p><b>Return plenum with 6 circular inlets DN 160 mm. For P-FSN45.</b></p> <p>-----</p> <p>PCZ-AHRD0464</p>	<p><b>90° shooting plenum. For P-FSN45 and P-FSQ60.</b></p> <p>-----</p> <p>PCZ-AHRD0524</p>	<p><b>Telescopic kit for rear or directly coupled suction. 153 mm - 270 mm. For P-FSN45.</b></p> <p>-----</p> <p>PCZ-AHRD0534</p>	<p><b>Grille for telescopic kit for rear intake. For P-FSN45.</b></p> <p>-----</p> <p>PCZ-AHRD0544</p>		
<p><b>Replacement recirculation filter kit. For P-FSN55, P-FTN45, P-FSQ75 and P-FTQ65.</b></p> <p>-----</p> <p>PCZ-AHRD0495</p>	<p><b>Delivery plate with 7 circular inlets DN 160 mm. For P-FSN55.</b></p> <p>-----</p> <p>PCZ-AHRD0435</p>	<p><b>Return plenum with 7 circular inlets DN 160 mm. For P-FSN55.</b></p> <p>-----</p> <p>PCZ-AHRD0465</p>	<p><b>90° shooting plenum. For P-FSN55 and P-FSQ75.</b></p> <p>-----</p> <p>PCZ-AHRD0525</p>	<p><b>Telescopic kit for rear or directly coupled suction. 153 mm - 270 mm. For P-FSN55.</b></p> <p>-----</p> <p>PCZ-AHRD0535</p>	<p><b>Grille for telescopic kit for rear intake. For P-FSN55.</b></p> <p>-----</p> <p>PCZ-AHRD0545</p>		

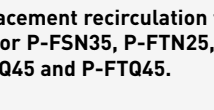
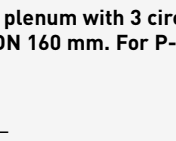
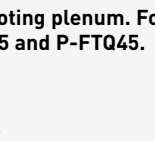
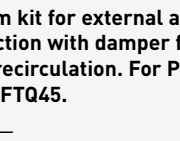
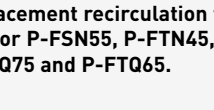
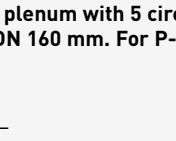
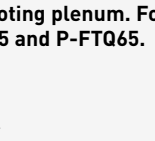
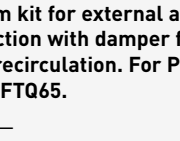
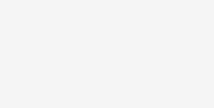
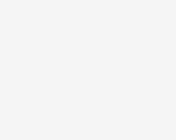
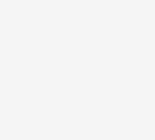
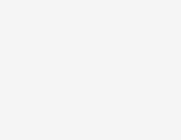
Outdoor air kit	Ducting plate outdoor air kit	90° plenum for outdoor air kit with damper	Telescopic kit for outdoor air kit	Grille for telescopic kit for outdoor air kit
 <p>Plenum kit for external air connection with damper for room recirculation. For P-FSN20.</p> <p>----- PCZ-AHRD0639</p>	 <p>Ducting plate plenum kit for outdoor air connection with damper. For P-FSN20.</p> <p>----- PCZ-AHRD0651</p>	 <p>90° plenum for outdoor air kit with damper. For P-FSN20.</p> <p>----- PCZ-AHRD0656</p>	 <p>Telescopic kit. For plenum for outdoor air kit with damper. For P-FSN20.</p> <p>----- PCZ-AHRD0661</p>	 <p>Grille for telescopic kit. For plenum for outdoor air kit with damper. For P-FSN20.</p> <p>----- PCZ-AHRD0666</p>
<p>Plenum kit for external air connection with damper for room recirculation. For P-FSN25 and P-FSQ30.</p> <p>----- PCZ-AHRD0640</p>	<p>Ducting plate plenum kit for outdoor air connection with damper. For P-FSN25 and P-FSQ30.</p> <p>----- PCZ-AHRD0652</p>	<p>90° plenum for outdoor air kit with damper. For P-FSN25 and P-FSQ30.</p> <p>----- PCZ-AHRD0657</p>	<p>Telescopic kit. For plenum for outdoor air kit with damper. For P-FSN25 and P-FSQ30.</p> <p>----- PCZ-AHRD0662</p>	<p>Grille for telescopic kit. For plenum for outdoor air kit with damper. For P-FSN25 and P-FSQ30.</p> <p>----- PCZ-AHRD0667</p>
<p>Plenum kit for external air connection with damper for room recirculation. For P-FSN35 and P-FSQ45.</p> <p>----- PCZ-AHRD0641</p>	<p>Ducting plate plenum kit for outdoor air connection with damper. For P-FSN35 and P-FSQ45.</p> <p>----- PCZ-AHRD0653</p>	<p>90° plenum for outdoor air kit with damper. For P-FSN35 and P-FSQ45.</p> <p>----- PCZ-AHRD0658</p>	<p>Telescopic kit. For plenum for outdoor air kit with damper. For P-FSN35 and P-FSQ45.</p> <p>----- PCZ-AHRD0663</p>	<p>Grille for telescopic kit. For plenum for outdoor air kit with damper. For P-FSN35 and P-FSQ45.</p> <p>----- PCZ-AHRD0668</p>
<p>Plenum kit for external air connection with damper for room recirculation. For P-FSN45 and P-FSQ60.</p> <p>----- PCZ-AHRD0642</p>	<p>Ducting plate plenum kit for outdoor air connection with damper. For P-FSN45 and P-FSQ60.</p> <p>----- PCZ-AHRD0654</p>	<p>90° plenum for outdoor air kit with damper. For P-FSN45 and P-FSQ60.</p> <p>----- PCZ-AHRD0659</p>	<p>Telescopic kit. For plenum for outdoor air kit with damper. For P-FSN45 and P-FSQ60.</p> <p>----- PCZ-AHRD0664</p>	<p>Grille for telescopic kit. For plenum for outdoor air kit with damper. For P-FSN45 and P-FSQ60.</p> <p>----- PCZ-AHRD0669</p>
<p>Plenum kit for external air connection with damper for room recirculation. For P-FSN55 and P-FSQ75.</p> <p>----- PCZ-AHRD0643</p>	<p>Ducting plate plenum kit for outdoor air connection with damper. For P-FSN55 and P-FSQ75.</p> <p>----- PCZ-AHRD0655</p>	<p>90° plenum for outdoor air kit with damper. For P-FSN55 and P-FSQ75.</p> <p>----- PCZ-AHRD0660</p>	<p>Telescopic kit. For plenum for outdoor air kit with damper. For P-FSN55 and P-FSQ75.</p> <p>----- PCZ-AHRD0665</p>	<p>Grille for telescopic kit. For plenum for outdoor air kit with damper. For P-FSN55 and P-FSQ75.</p> <p>----- PCZ-AHRD0670</p>

Aquarea Air Smart fan coil ducted multi zone thin accessories

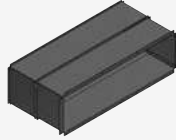
Control accessories		Hydraulic accessories	
 <p><b>Wall-mounted control with Modbus for Aquarea Air Smart fan coils.</b></p> <p>-----</p> <p>PCZ-EEB749</p>	 <p><b>Wall-mounted control with Integrated Wi-Fi for Aquarea Air Smart fan coils.</b></p> <p>-----</p> <p>PCZ-EFB749</p>	 <p><b>Motorised 3 way valve for Aquarea Air ducted.</b></p> <p>-----</p> <p>PCZ-V30361</p>	 <p><b>Motorised 2 way valve for Aquarea Air floor standing, wall-mounted 40 and ducted.</b></p> <p>-----</p> <p>PCZ-V20139</p>
Replacement filter kit	Return plenum	90° shooting plenum	Outdoor air kit
 <p><b>Replacement recirculation filter kit. For P-FSN25, P-FTN20, P-FSQ30 and P-FTQ30.</b></p> <p>-----</p> <p>PCZ-AHRD0492</p>	 <p><b>Return plenum with 2 circular inlets DN 160 mm. For P-FTQ30.</b></p> <p>-----</p> <p>PCZ-AHRD0682</p>	 <p><b>90° shooting plenum. For P-FTN20 and P-FTQ30.</b></p> <p>-----</p> <p>PCZ-AHRD0577</p>	 <p><b>Plenum kit for external air connection with damper for room recirculation. For P-FTN20 and P-FTQ30.</b></p> <p>-----</p> <p>PCZ-AHRD0572</p>
 <p><b>Replacement recirculation filter kit. For P-FSN35, P-FTN25, P-FSQ45 and P-FTQ45.</b></p> <p>-----</p> <p>PCZ-AHRD0493</p>	 <p><b>Return plenum with 3 circular inlets DN 160 mm. For P-FTQ45.</b></p> <p>-----</p> <p>PCZ-AHRD0683</p>	 <p><b>90° shooting plenum. For P-FTN25 and P-FTQ45.</b></p> <p>-----</p> <p>PCZ-AHRD0578</p>	 <p><b>Plenum kit for external air connection with damper for room recirculation. For P-FTN25 and P-FTQ45.</b></p> <p>-----</p> <p>PCZ-AHRD0573</p>
 <p><b>Replacement recirculation filter kit. For P-FSN45, P-FTN35, P-FSQ60 and P-FTQ60.</b></p> <p>-----</p> <p>PCZ-AHRD0494</p>	 <p><b>Return plenum with 4 circular inlets DN 160 mm. For P-FTQ60.</b></p> <p>-----</p> <p>PCZ-AHRD0684</p>	 <p><b>90° shooting plenum. For P-FTN35 and P-FTQ60.</b></p> <p>-----</p> <p>PCZ-AHRD0579</p>	 <p><b>Plenum kit for external air connection with damper for room recirculation. For P-FTN35 and P-FTQ60.</b></p> <p>-----</p> <p>PCZ-AHRD0574</p>
 <p><b>Replacement recirculation filter kit. For P-FSN55, P-FTN45, P-FSQ75 and P-FTQ65.</b></p> <p>-----</p> <p>PCZ-AHRD0495</p>	 <p><b>Return plenum with 5 circular inlets DN 160 mm. For P-FTQ65.</b></p> <p>-----</p> <p>PCZ-AHRD0685</p>	 <p><b>90° shooting plenum. For P-FTN45 and P-FTQ65.</b></p> <p>-----</p> <p>PCZ-AHRD0580</p>	 <p><b>Plenum kit for external air connection with damper for room recirculation. For P-FTN45 and P-FTQ65.</b></p> <p>-----</p> <p>PCZ-AHRD0575</p>

Ducting plate outdoor air kit	90° plenum for outdoor air kit with damper	Telescopic kit for outdoor air kit	Grille for telescopic kit for outdoor air kit
 <p><b>Ducting plate plenum kit for outdoor air connection with damper. For P-FTN20 and P-FTQ30.</b></p> <p>----- PCZ-AHRD0612</p>	 <p><b>90° plenum for outdoor air kit with damper. For P-FTN20 and P-FTQ30.</b></p> <p>----- PCZ-AHRD0617</p>	 <p><b>Telescopic kit. For plenum for outdoor air kit with damper. For P-FTN20 and P-FTQ30.</b></p> <p>----- PCZ-AHRD0622</p>	 <p><b>Grille for telescopic kit. For plenum for outdoor air kit with damper. For P-FTN20 and P-FTQ30.</b></p> <p>----- PCZ-AHRD0627</p>
<p><b>Ducting plate plenum kit for outdoor air connection with damper. For P-FTN25 and P-FTQ45.</b></p> <p>----- PCZ-AHRD0613</p>	<p><b>90° plenum for outdoor air kit with damper. For P-FTN25 and P-FTQ45.</b></p> <p>----- PCZ-AHRD0618</p>	<p><b>Telescopic kit. For plenum for outdoor air kit with damper. For P-FTN25 and P-FTQ45.</b></p> <p>----- PCZ-AHRD0623</p>	<p><b>Grille for telescopic kit. For plenum for outdoor air kit with damper. For P-FTN25 and P-FTQ45.</b></p> <p>----- PCZ-AHRD0628</p>
<p><b>Ducting plate plenum kit for outdoor air connection with damper. For P-FTN35 and P-FTQ60.</b></p> <p>----- PCZ-AHRD0614</p>	<p><b>90° plenum for outdoor air kit with damper. For P-FTN35 and P-FTQ60.</b></p> <p>----- PCZ-AHRD0619</p>	<p><b>Telescopic kit. For plenum for outdoor air kit with damper. For P-FTN35 and P-FTQ60.</b></p> <p>----- PCZ-AHRD0624</p>	<p><b>Grille for telescopic kit. For plenum for outdoor air kit with damper. For P-FTN35 and P-FTQ60.</b></p> <p>----- PCZ-AHRD0629</p>
<p><b>Ducting plate plenum kit for outdoor air connection with damper. For P-FTN45 and P-FTQ65.</b></p> <p>----- PCZ-AHRD0615</p>	<p><b>90° plenum for outdoor air kit with damper. For P-FTN45 and P-FTQ65.</b></p> <p>----- PCZ-AHRD0620</p>	<p><b>Telescopic kit. For plenum for outdoor air kit with damper. For P-FTN45 and P-FTQ65.</b></p> <p>----- PCZ-AHRD0625</p>	<p><b>Grille for telescopic kit. For plenum for outdoor air kit with damper. For P-FTN45 and P-FTQ65.</b></p> <p>----- PCZ-AHRD0630</p>







#### Non-return damper



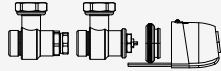

#### Non-return damper for P-FTQ and P-FSQ.

-----  
PCZ-AHRD0519

Aquarea Air Smart fan coil ducted multi zone accessories

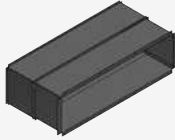
Control accessories		Hydraulic accessories	
 <p><b>Wall-mounted control with Modbus for Aquarea Air Smart fan coils.</b></p> <p>-----</p> <p>PCZ-EEB749</p>	 <p><b>Wall-mounted control with Integrated Wi-Fi for Aquarea Air Smart fan coils.</b></p> <p>-----</p> <p>PCZ-EFB749</p>	 <p><b>Motorised 3 way valve for Aquarea Air ducted.</b></p> <p>-----</p> <p>PCZ-V30361</p>	 <p><b>Motorised 2 way valve for Aquarea Air floor standing, wall-mounted 40 and ducted.</b></p> <p>-----</p> <p>PCZ-V20139</p>
Replacement filter kit	Return plenum	90° shooting plenum	Outdoor air kit
 <p><b>Replacement recirculation filter kit. For P-FSN25, P-FTN20, P-FSQ30 and P-FTQ30.</b></p> <p>-----</p> <p>PCZ-AHRD0492</p> <p><b>Replacement recirculation filter kit. For P-FSN35, P-FTN25, P-FSQ45 and P-FTQ45.</b></p> <p>-----</p> <p>PCZ-AHRD0493</p> <p><b>Replacement recirculation filter kit. For P-FSN45, P-FTN35, P-FSQ60 and P-FTQ60.</b></p> <p>-----</p> <p>PCZ-AHRD0494</p> <p><b>Replacement recirculation filter kit. For P-FSN55, P-FTN45, P-FSQ75 and P-FTQ65.</b></p> <p>-----</p> <p>PCZ-AHRD0495</p>	 <p><b>Return plenum with 2 circular inlets DN 160 mm. For P-FSQ30.</b></p> <p>-----</p> <p>PCZ-AHRD0466</p> <p><b>Return plenum with 3 circular inlets DN 160 mm. For P-FSQ45.</b></p> <p>-----</p> <p>PCZ-AHRD0467</p> <p><b>Return plenum with 4 circular inlets DN 160 mm. For P-FSQ60.</b></p> <p>-----</p> <p>PCZ-AHRD0468</p> <p><b>Return plenum with 5 circular inlets DN 160 mm. For P-FSQ75.</b></p> <p>-----</p> <p>PCZ-AHRD0469</p>	 <p><b>90° shooting plenum. For P-FSN25 and P-FSQ30.</b></p> <p>-----</p> <p>PCZ-AHRD0522</p> <p><b>90° shooting plenum. For P-FSN35 and P-FSQ45.</b></p> <p>-----</p> <p>PCZ-AHRD0523</p> <p><b>90° shooting plenum. For P-FSN45 and P-FSQ60.</b></p> <p>-----</p> <p>PCZ-AHRD0524</p> <p><b>90° shooting plenum. For P-FSN55 and P-FSQ75.</b></p> <p>-----</p> <p>PCZ-AHRD0525</p>	 <p><b>Plenum kit for external air connection with damper for room recirculation. For P-FSN25 and P-FSQ30.</b></p> <p>-----</p> <p>PCZ-AHRD0640</p> <p><b>Plenum kit for external air connection with damper for room recirculation. For P-FSN35 and P-FSQ45.</b></p> <p>-----</p> <p>PCZ-AHRD0641</p> <p><b>Plenum kit for external air connection with damper for room recirculation. For P-FSN45 and P-FSQ60.</b></p> <p>-----</p> <p>PCZ-AHRD0642</p> <p><b>Plenum kit for external air connection with damper for room recirculation. For P-FSN55 and P-FSQ75.</b></p> <p>-----</p> <p>PCZ-AHRD0643</p>

90° plenum for outdoor air kit with damper	Telescopic kit for outdoor air kit	Grille for telescopic kit for outdoor air kit
 <p><b>90° plenum for outdoor air kit with damper. For P-FSN25 and P-FSQ30.</b></p> <p>----- PCZ-AHRD0657</p>	 <p><b>Telescopic kit. For plenum for outdoor air kit with damper. For P-FSN25 and P-FSQ30.</b></p> <p>----- PCZ-AHRD0662</p>	 <p><b>Grille for telescopic kit. For plenum for outdoor air kit with damper. For P-FSN25 and P-FSQ30.</b></p> <p>----- PCZ-AHRD0667</p>
<p><b>90° plenum for outdoor air kit with damper. For P-FSN35 and P-FSQ45.</b></p> <p>----- PCZ-AHRD0658</p>	<p><b>Telescopic kit. For plenum for outdoor air kit with damper. For P-FSN35 and P-FSQ45.</b></p> <p>----- PCZ-AHRD0663</p>	<p><b>Grille for telescopic kit. For plenum for outdoor air kit with damper. For P-FSN35 and P-FSQ45.</b></p> <p>----- PCZ-AHRD0668</p>
<p><b>90° plenum for outdoor air kit with damper. For P-FSN45 and P-FSQ60.</b></p> <p>----- PCZ-AHRD0659</p>	<p><b>Telescopic kit. For plenum for outdoor air kit with damper. For P-FSN45 and P-FSQ60.</b></p> <p>----- PCZ-AHRD0664</p>	<p><b>Grille for telescopic kit. For plenum for outdoor air kit with damper. For P-FSN45 and P-FSQ60.</b></p> <p>----- PCZ-AHRD0669</p>
<p><b>90° plenum for outdoor air kit with damper. For P-FSN55 and P-FSQ75.</b></p> <p>----- PCZ-AHRD0660</p>	<p><b>Telescopic kit. For plenum for outdoor air kit with damper. For P-FSN55 and P-FSQ75.</b></p> <p>----- PCZ-AHRD0665</p>	<p><b>Grille for telescopic kit. For plenum for outdoor air kit with damper. For P-FSN55 and P-FSQ75.</b></p> <p>----- PCZ-AHRD0670</p>

**Non-return damper**











**Non-return damper for P-FTQ and P-FSQ.**

-----  
PCZ-AHRD0519

**Fan coil units controllers**



 <p><b>Electro-mechanical controller (supplied loose).</b></p> <p>----- TRM-FA</p>	 <p><b>Electronic controller.</b></p> <p>----- Plogic</p>	 <p><b>Electronic controller.</b></p> <p>----- TControl EASY 3S</p>	 <p><b>Electronic controller.</b></p> <p>----- TControl POD glass</p>
 <p><b>Wired remote controller with touch control for 2-pipe and 4-pipe, EC fan coil (control + Modbus).</b></p> <p>----- PAW-FC-907EC</p> <p><b>Wired remote controller with touch control for 2-pipe, AC fan coil (control only).</b></p> <p>----- PAW-FC-907AC</p>	 <p><b>Wired remote controller for 2-pipe and 4-pipe, EC fan coil (control + Modbus).</b></p> <p>----- PAW-FC-903EC</p> <p><b>Wired remote controller for 2-pipe, AC fan coil (control only).</b></p> <p>----- PAW-FC-903AC</p>	 <p><b>Advanced wired remote controller for fan coil.</b></p> <p>----- PAW-FC-RC1</p>	 <p><b>Smart controller. Mini building management system.</b></p> <p>----- SRC</p>



**Plogic remote control.**

-----  
WRC / MRC



**Plogic remote control.**

-----  
BRC



**Plogic remote control.**

-----  
IRC

**Sanitary tank accessories**



**Tank sensor with 5 m cable length.**

-----  
PAW-TS1

**Tank sensor with 20 m cable length.**

-----  
PAW-TS2

**Tank sensor with 5 m cable length and only 6 mm diameter.**

-----  
PAW-TS4



**Temperature sensor kit for third party tank (with copper pocket and 20 m length sensor cable).**

-----  
CZ-TK1

**Impressed current anode for 200 L Stainless steel tanks.**

-----  
PAW-EANODE2



**Impressed current anode for 300 L Stainless steel tanks.**

-----  
PAW-EANODE3

**Heat recovery ventilation accessories**



**Supply and extract filters kit.**

-----  
PAW-VEN-FLTKit



**Optional PCB for additional functions.**

-----  
PAW-VEN-ACCPCB



**HRV touch control panel. White frame (cable must be ordered separately).**

-----  
PAW-VEN-DPL



**Cable with plug for electrical connection between unit and control panel, type CE and CD (12 m).**

-----  
PAW-VEN-CBLEXT12



**Twin plugs for installation of several control panels type CD or CE for one unit.**

-----  
PAW-VEN-DIVPLG



**HRV touch control panel wall-mounted kit.**

-----  
PAW-VEN-DPLBOX



**CO<sub>2</sub> RH wall-mounted sensor.**

-----  
PAW-VEN-S-CO2RH-W



**CO<sub>2</sub> wall-mounted sensor.**

-----  
PAW-VEN-S-CO2-W



**CO<sub>2</sub> duct sensor.**

-----  
PAW-VEN-S-CO2-D



**Wall bracket kit for stand-alone installation on the wall.**

-----  
PAW-VEN-WBRK



**Electrical duct heater 0,6 kW (includes relay).**

-----  
PAW-VEN-HTR06





**Electrical duct heater 1,2 kW (includes relay).**

-----  
PAW-VEN-HTR12





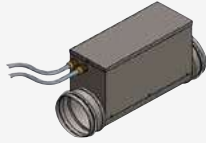

**Aquarea Vent accessories**

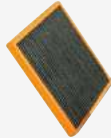



Remote controller (required, to be ordered separately)		Electrical duct heater	
			
<b>Wall-mounted control with Modbus for Aquarea Vent.</b>	<b>Wall-mounted control with Integrated Wi-Fi for Aquarea Vent.</b>	<b>Electrical duct heater 0,5 kW, DN 160 mm.</b>	<b>Electrical duct heater 1,0 kW, DN 160 mm.</b>
----- PCZ-AHRP0025	----- PCZ-AHRP0026	----- PCZ-AHRP0421	----- PCZ-AHRP0422

**Filters**





	
<b>Spare F7 filter kit (2 pcs) for models 15Z, 20Z, 30Z, 15H and 15V.</b>	<b>Activated carbon filter (1 pc) for models 15Z, 20Z, 30Z, 15H and 15V.</b>
----- PCZ-AHRP0501	----- PCZ-AHRP0901
<b>Spare F7 filter kit (2 pcs) for models 30H.</b>	<b>Activated carbon filter (1 pc) for models 30H.</b>
----- PCZ-AHRP0507	----- PCZ-AHRP0508
<b>Spare F7 filter kit (2 pcs) for models 30V.</b>	<b>Activated carbon filter (1 pc) for models 30V.</b>
----- PCZ-AHRP0502	----- PCZ-AHRP0902
<b>Spare F7 filter kit (2 pcs) for models 35H and 45H.</b>	<b>Activated carbon filter (1 pc) for models 35H and 45H.</b>
----- PCZ-AHRP0503	----- PCZ-AHRP0903
<b>Spare F7 filter kit (2 pcs) for models 40V and 45V.</b>	<b>Activated carbon filter (1 pc) for models 40V and 45V.</b>
----- PCZ-AHRP0504	----- PCZ-AHRP0904

Filters	External roof grill		
			
<b>External wall grid with flow deviation. Stainless steel, DN 160 mm.</b>	<b>Roof terminal. Stainless steel, DN 160 mm.</b>	<b>Through for flat roof terminal. Stainless steel, DN 160 mm.</b>	<b>Through insulation collar for roof terminal.</b>
----- PCZ-STE016181	----- PCZ-STE016185	----- PCZ-STE016190	----- PCZ-STE080189
		<b>Through for terminal inclined roof 45°. Stainless steel, DN 160 mm.</b>	
		----- PCZ-STE016191	

Primary pipe connections

 <p><b>Insulated joint male/male. DN 160 mm.</b></p> <p>----- PCZ-SRA116110</p>	 <p><b>Insulated sleeve female/female. DN 160 mm.</b></p> <p>----- PCZ-SRA116120</p>	 <p><b>Insulated reducer female/male. DN 160 mm to DN 125 mm.</b></p> <p>----- PCZ-SRA112132</p>	 <p><b>Insulated reducer female/male. DN 200 mm to DN 160 mm.</b></p> <p>----- PCZ-SRA116132</p>
--	---	---	---

Primary EPP connections

 <p><b>Rigid insulated pipe (primary EPP pipe). DN 160 mm, L= 1 mt, 1 joint included.</b></p> <p>----- PCZ-SCS116001</p>	 <p><b>Elbow 90° (primary EPP pipe). DN 160 mm, 1 joint included.</b></p> <p>----- PCZ-SCS116090</p>	 <p><b>Connection joint (primary EPP pipe). DN 160 mm.</b></p> <p>----- PCZ-SCS116160</p>	 <p><b>Reducer (primary EPP pipe). DN 160 mm to DN 125mm.</b></p> <p>----- PCZ-SCS116120</p>
---	---	--	---







Primary flexible pipe

Flexible pipe connections

Silencers

 <p><b>10 m primary flexible duct with insulated hose. DH 160 mm.</b></p> <p>----- PCZ-SCE116010</p>	 <p><b>10 m primary flexible duct with insulated aluphonic hose. DH 160 mm.</b></p> <p>----- PCZ-SCE316010</p>	 <p><b>Hose clamp for hose. 60/325 mm.</b></p> <p>----- PCZ-SCE099120</p>	 <p><b>Black air-tight anti-condensation tape. 50 mm x 10 m.</b></p> <p>----- PCZ-SCE199121</p>	 <p><b>Aluminium tape. 50 mm x 10 m. Sp 40 µm.</b></p> <p>----- PCZ-SCE199122</p>	 <p><b>Flexible silencer male/male. DN 160 mm, SP 25 mm, L= 1000 mm.</b></p> <p>----- PCZ-SCE216001</p>
--	--	---	---	---	---

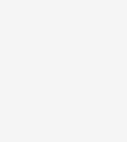
Distribution manifolds and accessories

 <p><b>TG1 insulated steel manifold with inspection door and side/front/perpendicular exits. 1x DN 160 mm - 4+4+4x DN 75/90 mm.</b></p> <p>----- PCZ-SCO164044</p>	 <p><b>TG2 insulated steel manifold with inspection door and side/front/perpendicular exits. 1x DN 160 mm - 4+8+4x DN 75/90 mm.</b></p> <p>----- PCZ-SCO164084</p>	 <p><b>TG3 insulated steel manifold with inspection door and side/front/perpendicular exits. 1x DN 160 mm - 4+12+4x DN 75/90 mm.</b></p> <p>----- PCZ-SCO164124</p>
 <p><b>Manifold/ plenum coupling for DN 75 mm corrugated start.</b></p> <p>----- PCZ-SRS075140</p>	 <p><b>Collector blind plug for manifold.</b></p> <p>----- PCZ-SRS080141</p>	 <p><b>Static flow regulator. 15=&gt; 50 m³/h, step minimum= 5 m³/h.</b></p> <p>----- PCZ-SRP080001</p>

## Corrugated pipe system with accessories

					
<b>50 m corrugated pipe coil. DN 75 mm.</b>	<b>O-Ring. DN 75 mm.</b>	<b>Corrugated pipe blind plug. DN 75 mm.</b>	<b>Joint male/male. DN 75 mm including two O-ring.</b>	<b>Fixing clip. DN 75 mm. Use every 1,5 - 2 m linear and before and after each curve.</b>	<b>90° vertical angle. DN 75 mm. Two O-rings included.</b>
PCZ-SRS075050	PCZ-SRS075145	PCZ-SRS075150	PCZ-SRS075120	PCZ-SRS075155	PCZ-SRS075160

## Room plenum

	<b>Replacement filter (10 pcs).</b>
<b>EPP polypropylene diffuser, modular and patented with 75/90 mm coupling, coupling for modular coupling, filter and installation brackets.</b>	
PCZ-REV081111	PCZ-SB0130860

## Room grills with round holes

			
<b>Grid 1x perforated round hole. Steel, white finish, 190 x 140 mm.</b>	<b>Grid 2x perforated round hole. Steel, white finish, 360 x 140 mm.</b>	<b>Grid 3x perforated round hole. Steel, white finish, 540 x 140 mm.</b>	<b>Grid 4x perforated round hole. Steel, white finish, 360 x 260 mm.</b>
PCZ-SB0130801	PCZ-SB0300801	PCZ-SB0480801	PCZ-SB0302001

## Room grills with square holes

			
<b>Grid 1x perforated square hole. Steel, white finish, 190 x 140 mm.</b>	<b>Grid 2x perforated square hole. Steel, white finish, 360 x 140 mm.</b>	<b>Grid 3x perforated square hole. Steel, white finish, 540 x 140 mm.</b>	<b>Grid 5x perforated square hole. Steel, white finish, 360 x 260 mm.</b>
PCZ-SB0130802	PCZ-SB0300802	PCZ-SB0480802	PCZ-SB0302002

# Heating and cooling capacity tables

Based on outlet temperature and outside temperature.

## Aquarea High Performance Hydraulic All in One L Series Single phase - R290

### WH-WDG05LE5

Tamb	HC	IP	COP	HC	IP	COP	HC	IP	COP	HC	IP	COP	HC	IP	COP
LWC	35	35	35	45	45	45	55	55	55	65	65	65	75	75	75
-25	2,45	1,76	1,39	3,80	2,30	1,65	3,60	2,46	1,46	—	—	—	—	—	—
-20	4,70	2,19	2,15	4,50	2,37	1,90	4,25	2,57	1,65	—	—	—	—	—	—
-15	5,00	1,94	2,58	5,00	2,31	2,16	5,00	2,63	1,90	4,60	2,88	1,60	—	—	—
-7	5,00	1,66	3,01	5,00	1,94	2,58	5,00	2,36	2,12	5,00	2,62	1,91	4,30	2,87	1,50
2	5,00	1,42	3,52	5,00	1,71	2,92	5,00	2,14	2,34	5,00	2,54	1,97	4,60	2,76	1,67
7	5,00	0,99	5,05	5,00	1,27	3,94	5,00	1,63	3,07	5,00	2,03	2,46	4,70	2,57	1,83

### WH-WDG07LE5

Tamb	HC	IP	COP	HC	IP	COP	HC	IP	COP	HC	IP	COP	HC	IP	COP
LWC	35	35	35	45	45	45	55	55	55	65	65	65	75	75	75
-25	4,75	2,53	1,88	4,30	2,66	1,62	3,95	2,78	1,42	—	—	—	—	—	—
-20	5,50	2,56	2,15	5,10	2,75	1,85	4,90	2,97	1,65	—	—	—	—	—	—
-15	6,00	2,50	2,40	5,50	2,60	2,12	5,20	2,89	1,80	4,80	3,00	1,60	—	—	—
-7	5,80	1,93	3,01	5,80	2,32	2,50	5,80	2,74	2,12	5,70	3,16	1,80	4,80	3,56	1,35
2	6,85	2,00	3,43	6,60	2,34	2,82	6,25	2,67	2,34	5,60	2,80	2,00	5,00	3,13	1,60
7	7,00	1,42	4,93	7,00	1,90	3,68	7,00	2,35	2,98	6,60	2,85	2,32	6,30	3,40	1,85

### WH-WDG09LE5

Tamb	HC	IP	COP	HC	IP	COP	HC	IP	COP	HC	IP	COP	HC	IP	COP
LWC	35	35	35	45	45	45	55	55	55	65	65	65	75	75	75
-25	6,05	3,43	1,76	5,25	3,28	1,60	4,65	3,15	1,48	—	—	—	—	—	—
-20	7,00	3,56	1,97	6,20	3,50	1,77	5,60	3,43	1,63	—	—	—	—	—	—
-15	7,40	3,20	2,31	6,80	3,40	2,00	6,30	3,55	1,77	5,60	3,55	1,58	—	—	—
-7	7,00	2,50	2,80	7,00	2,98	2,35	7,00	3,29	2,13	6,50	3,53	1,84	5,40	3,56	1,52
2	7,00	2,05	3,41	7,00	2,50	2,80	7,00	2,90	2,41	6,70	3,35	2,00	5,70	3,40	1,68
7	9,00	1,98	4,55	9,00	2,58	3,49	8,90	2,94	3,03	8,90	3,56	2,50	7,30	3,56	2,05

## Aquarea High Performance Hydraulic All in One L Series Single phase - R290

### WH-WDG05LE5

Tamb	CC	IP	EER	CC	IP	EER	CC	IP	EER
LWC	7	7	7	14	14	14	18	18	18
16	6,00	1,01	5,94	7,50	1,05	7,14	6,00	0,67	8,96
25	5,70	1,20	4,75	7,00	1,20	5,83	5,70	0,78	7,31
35	5,00	1,55	3,23	6,30	1,44	4,38	5,00	1,00	5,00
43	4,50	1,60	2,81	5,60	1,64	3,41	4,50	1,12	4,02

### WH-WDG07LE5

Tamb	CC	IP	EER	CC	IP	EER	CC	IP	EER
LWC	7	7	7	14	14	14	18	18	18
16	7,00	1,36	5,15	8,50	1,39	6,12	8,00	1,04	7,69
25	7,00	1,65	4,24	8,00	1,57	5,10	7,50	1,18	6,36
35	7,00	2,31	3,03	8,00	2,26	3,54	7,00	1,48	4,73
43	6,00	2,50	2,40	7,00	2,60	2,69	5,70	1,70	3,35

### WH-WDG09LE5

Tamb	CC	IP	EER	CC	IP	EER	CC	IP	EER
LWC	7	7	7	14	14	14	18	18	18
16	9,00	2,00	4,50	11,00	2,12	5,19	11,00	1,80	6,11
25	9,00	2,50	3,60	11,00	2,60	4,23	10,00	1,85	5,41
35	8,20	2,91	2,82	10,00	3,10	3,23	9,00	2,15	4,19
43	6,40	2,67	2,40	7,40	2,70	2,74	8,20	2,50	3,28

Tamb: Ambient Temperature [°C]. LWC: Leaving Water Condenser Temperature [°C]. HC: Heating Capacity (kW). CC: Cooling Capacity (kW). IP: Input Power (kW). This data is measured by Panasonic in accordance with EN 14511-2 standard. This data is for reference purpose only, and does not guarantee the performance.

## Aquarea High Performance Mono-bloc J Series Single phase - MDC · R32

## WH-MDC05J3E5

Tamb	HC	IP	COP	HC	IP	COP	HC	IP	COP	HC	IP	COP	HC	IP	COP
LWC	25	25	25	35	35	35	45	45	45	55	55	55	60	60	60
-20	4,37	1,73	2,53	4,16	2,03	2,05	3,84	2,37	1,62	3,43	2,64	1,30	—	—	—
-15	5,13	1,78	2,88	5,00	2,17	2,30	4,75	2,51	1,89	3,70	2,45	1,51	—	—	—
-7	5,17	1,49	3,47	5,00	1,80	2,78	4,80	2,16	2,22	5,00	2,70	1,85	4,68	2,71	1,73
2	5,00	1,11	4,50	5,00	1,40	3,57	5,00	1,81	2,76	5,00	2,20	2,27	4,80	2,40	2,00
7	5,09	0,78	6,53	5,00	0,99	5,05	5,00	1,31	3,82	5,00	1,66	3,01	4,58	1,90	2,41
25	4,96	0,77	6,44	5,04	0,90	5,60	5,31	1,16	4,58	5,61	1,34	4,19	5,15	1,33	3,87

## WH-MDC07J3E5

Tamb	HC	IP	COP	HC	IP	COP	HC	IP	COP	HC	IP	COP	HC	IP	COP
LWC	25	25	25	35	35	35	45	45	45	55	55	55	60	60	60
-20	4,86	2,03	2,39	4,66	2,35	1,98	4,44	2,75	1,61	4,23	3,13	1,35	—	—	—
-15	5,80	2,11	2,75	5,60	2,40	2,33	5,30	2,84	1,87	5,00	3,32	1,51	—	—	—
-7	6,76	2,07	3,27	6,80	2,42	2,81	6,30	2,82	2,23	6,30	3,39	1,86	4,74	2,76	1,72
2	6,83	1,66	4,11	7,00	2,06	3,40	6,85	2,50	2,74	6,30	2,92	2,16	4,80	2,40	2,00
7	7,32	1,19	6,15	7,00	1,47	4,76	7,00	1,96	3,57	7,00	2,48	2,82	6,18	2,44	2,53
25	6,80	0,64	10,63	6,67	0,93	7,17	6,79	1,38	4,92	6,70	1,80	3,72	6,22	1,78	3,49

## WH-MDC09J3E5

Tamb	HC	IP	COP	HC	IP	COP	HC	IP	COP	HC	IP	COP	HC	IP	COP
LWC	25	25	25	35	35	35	45	45	45	55	55	55	60	60	60
-20	5,33	2,36	2,26	6,43	3,60	1,79	5,78	3,83	1,51	4,83	3,64	1,33	—	—	—
-15	7,76	3,20	2,43	7,60	3,41	2,23	7,00	3,71	1,89	5,60	3,80	1,47	—	—	—
-7	7,39	2,45	3,02	7,50	2,85	2,63	7,30	3,37	2,17	7,00	3,89	1,80	6,44	3,67	1,75
2	7,38	1,89	3,90	7,45	2,38	3,13	7,00	2,85	2,46	7,00	3,30	2,12	5,46	2,72	2,01
7	9,15	1,59	5,75	9,00	2,01	4,48	9,00	2,61	3,45	8,95	3,22	2,78	7,25	2,87	2,53
25	8,02	0,98	8,18	7,88	1,32	5,97	8,46	1,86	4,55	7,60	2,03	3,74	6,30	1,87	3,37

## Aquarea High Performance Mono-bloc J Series Single phase - MDC · R32

## WH-MDC05J3E5

Tamb	CC	IP	EER	CC	IP	EER	CC	IP	EER
LWC	7	7	7	14	14	14	18	18	18
16	5,18	0,82	6,32	6,17	0,84	7,35	5,78	0,60	9,63
25	5,38	1,22	4,41	6,64	1,25	5,31	5,55	0,78	7,12
35	5,00	1,54	3,25	5,86	1,61	3,64	5,00	0,99	5,05
43	4,19	1,85	2,26	5,36	1,92	2,79	4,37	1,30	3,36

## WH-MDC07J3E5

Tamb	CC	IP	EER	CC	IP	EER	CC	IP	EER
LWC	7	7	7	14	14	14	18	18	18
16	5,38	0,83	6,48	6,69	0,85	7,87	7,65	0,76	10,07
25	6,96	1,82	3,82	9,06	1,98	4,58	7,58	1,23	6,16
35	7,00	2,29	3,06	8,37	2,47	3,39	7,00	1,48	4,73
43	5,60	2,55	2,20	6,87	2,58	2,66	6,10	1,88	3,24

## WH-MDC09J3E5

Tamb	CC	IP	EER	CC	IP	EER	CC	IP	EER
LWC	7	7	7	14	14	14	18	18	18
16	6,89	1,21	5,69	8,65	1,23	7,03	9,82	1,19	8,25
25	9,50	2,84	3,35	11,55	3,06	3,77	9,68	1,82	5,32
35	9,00	3,32	2,71	10,10	3,51	2,88	9,00	2,12	4,25
43	5,42	2,56	2,12	6,56	2,56	2,56	7,40	2,56	2,89

Tamb: Ambient Temperature [°C]. LWC: Leaving Water Condenser Temperature [°C]. HC: Heating Capacity [kW]. CC: Cooling Capacity [kW]. IP: Input Power [kW].  
This data is measured by Panasonic in accordance with EN 14511-2 standard. This data is for reference purpose only, and does not guarantee the performance.

# Heating and cooling capacity tables

Based on outlet temperature and outside temperature.

## Aquarea T-CAP Hydraulic Bi-bloc M Series Single phase / Three phase - R290

### WH-WXG09ME8

Tamb	HC	IP	COP	HC	IP	COP	HC	IP	COP	HC	IP	COP	HC	IP	COP	HC	IP	COP
LWC	25	25	25	35	35	35	45	45	45	55	55	55	65	65	65	75	75	75
-25	7,90	3,50	2,26	8,20	4,20	1,95	7,90	4,80	1,65	7,60	5,70	1,33	—	—	—	—	—	—
-20	7,90	2,94	2,69	8,20	3,34	2,46	7,90	3,99	1,98	7,60	4,76	1,60	7,10	5,30	1,34	—	—	—
-15	9,00	2,74	3,28	9,00	3,30	2,73	9,00	3,97	2,27	9,00	4,48	2,01	9,00	5,27	1,71	8,20	6,50	1,26
-7	9,00	2,26	3,98	9,00	2,61	3,45	9,00	3,35	2,69	9,00	3,83	2,35	9,00	4,68	1,92	9,00	5,90	1,53
2	8,80	1,95	4,51	9,00	2,36	3,81	9,00	2,91	3,09	9,00	3,54	2,54	9,00	4,29	2,10	9,00	5,50	1,64
7	9,00	1,24	7,26	9,00	1,72	5,23	9,00	2,30	3,91	9,00	2,78	3,24	9,00	3,46	2,60	8,90	4,98	1,79
25	7,20	0,86	8,37	9,00	1,08	8,33	9,00	1,55	5,81	9,00	2,05	4,39	9,00	2,68	3,36	8,40	3,45	2,43

### WH-WXG12ME8

Tamb	HC	IP	COP	HC	IP	COP	HC	IP	COP	HC	IP	COP	HC	IP	COP	HC	IP	COP
LWC	25	25	25	35	35	35	45	45	45	55	55	55	65	65	65	75	75	75
-25	10,20	4,90	2,08	10,50	5,55	1,89	9,50	5,75	1,65	8,65	5,90	1,47	—	—	—	—	—	—
-20	11,00	4,25	2,59	11,20	4,75	2,36	10,00	5,00	2,00	10,00	5,70	1,75	9,10	5,80	1,57	—	—	—
-15	12,00	4,27	2,81	12,00	4,56	2,63	11,50	5,42	2,12	11,00	5,50	2,00	10,00	5,88	1,70	9,00	6,10	1,48
-7	11,50	3,68	3,13	12,00	4,00	3,00	12,00	5,02	2,39	12,00	5,53	2,17	11,00	6,01	1,83	10,00	6,20	1,61
2	11,50	2,92	3,94	12,00	3,39	3,54	12,00	4,20	2,86	12,00	4,95	2,42	12,00	5,94	2,02	10,50	6,20	1,69
7	12,00	1,93	6,22	12,00	2,37	5,06	12,00	3,13	3,83	12,00	3,71	3,23	12,00	4,62	2,60	12,00	6,10	1,97
25	9,80	1,10	8,91	12,00	1,40	8,57	12,00	2,00	6,00	12,00	2,60	4,62	12,00	3,26	3,68	12,00	3,92	3,06

### WH-WXG16ME8

Tamb	HC	IP	COP	HC	IP	COP	HC	IP	COP	HC	IP	COP	HC	IP	COP	HC	IP	COP
LWC	25	25	25	35	35	35	45	45	45	55	55	55	65	65	65	75	75	75
-25	14,20	6,80	2,09	14,20	7,80	1,82	14,20	8,60	1,65	14,00	10,53	1,33	—	—	—	—	—	—
-20	14,20	5,40	2,63	14,20	6,10	2,33	14,20	6,90	2,06	14,20	8,10	1,75	14,20	10,16	1,40	—	—	—
-15	16,00	5,90	2,71	16,00	6,70	2,39	16,00	7,70	2,08	16,00	8,70	1,84	16,00	10,15	1,58	14,20	10,90	1,30
-7	16,00	5,40	2,96	16,00	6,32	2,53	16,00	7,10	2,25	16,00	8,12	1,97	16,00	9,40	1,70	16,00	10,30	1,55
2	16,00	3,63	4,41	16,00	4,85	3,30	16,00	5,88	2,72	16,00	6,75	2,37	16,00	8,15	1,96	16,00	9,99	1,60
7	16,00	2,70	5,93	16,00	3,27	4,89	16,00	4,19	3,82	16,00	5,00	3,20	16,00	6,30	2,54	16,00	7,60	2,11
25	16,00	1,45	11,03	16,00	1,99	8,04	16,00	2,85	5,61	16,00	3,65	4,38	16,00	4,75	3,37	16,00	6,30	2,54

## Aquarea T-CAP Hydraulic Bi-bloc M Series Single phase / Three phase - R290

### WH-WXG09ME8

Tamb	CC	IP	EER	CC	IP	EER	CC	IP	EER
LWC	7	7	7	14	14	14	18	18	18
16	9,80	2,00	4,90	11,00	2,04	5,39	10,80	1,38	7,83
25	9,30	2,28	4,08	10,50	2,35	4,47	10,20	1,49	6,85
35	9,00	2,49	3,61	9,80	2,63	3,73	9,00	1,71	5,26
43	8,40	2,80	3,00	9,00	2,88	3,13	8,60	2,00	4,30

### WH-WXG12ME8

Tamb	CC	IP	EER	CC	IP	EER	CC	IP	EER
LWC	7	7	7	14	14	14	18	18	18
16	12,00	2,50	4,80	13,70	2,60	5,27	12,00	1,73	6,94
25	12,00	3,05	3,93	13,50	3,12	4,33	12,00	1,88	6,38
35	12,00	4,21	2,85	13,20	3,25	4,06	12,00	2,80	4,29
43	9,60	4,35	2,21	10,00	4,35	2,30	12,00	3,60	3,33

### WH-WXG16ME8

Tamb	CC	IP	EER	CC	IP	EER	CC	IP	EER
LWC	7	7	7	14	14	14	18	18	18
16	15,50	3,00	5,17	15,80	2,75	5,75	16,00	2,50	6,40
25	15,00	3,75	4,00	15,50	3,40	4,56	16,00	3,10	5,16
35	14,50	5,05	2,87	14,50	4,50	3,22	15,50	3,95	3,92
43	12,00	5,15	2,33	12,00	5,20	2,31	15,00	5,35	2,80

Tamb: Ambient Temperature (°C). LWC: Leaving Water Condenser Temperature (°C). HC: Heating Capacity (kW). CC: Cooling Capacity (kW). IP: Input Power (kW). This data is measured by Panasonic in accordance with EN 14511-2 standard. This data is for reference purpose only, and does not guarantee the performance.

**Big Aquarea T-CAP Hydraulic Stand-alone M Series Three phase - R290**

**WH-WXG20ME8**

Tamb	HC	IP	COP	HC	IP	COP	HC	IP	COP	HC	IP	COP	HC	IP	COP	HC	IP	COP
LWC	25	25	25	35	35	35	45	45	45	55	55	55	65	65	65	75	75	75
-25	20,00	9,15	2,19	20,00	11,23	1,78	20,00	13,32	1,50	—	—	—	—	—	—	—	—	—
-20	20,00	8,55	2,34	20,00	10,50	1,90	20,00	12,45	1,61	20,00	14,40	1,39	On request			—	—	—
-15	20,00	6,80	2,94	20,00	8,53	2,34	20,00	10,27	1,95	20,00	12,00	1,67	20,00	10,45	1,91	—	—	—
-7	20,00	6,83	2,93	20,00	8,05	2,48	20,00	9,28	2,16	20,00	10,50	1,90	20,00	10,60	1,89	—	—	—
2	20,00	3,99	5,01	20,00	5,90	3,39	20,00	7,81	2,56	20,00	9,61	2,08	20,00	11,00	1,82	—	—	—
7	20,00	2,50	8,00	20,00	4,17	4,80	20,00	5,84	3,42	20,00	6,28	3,18	20,00	9,16	2,18	—	—	—
25	20,00	2,33	8,58	20,00	2,60	7,69	20,00	2,87	6,97	20,00	3,14	6,37	20,00	4,03	4,96	20,00	7,67	2,61

**WH-WXG25ME8**

Tamb	HC	IP	COP	HC	IP	COP	HC	IP	COP	HC	IP	COP	HC	IP	COP	HC	IP	COP
LWC	25	25	25	35	35	35	45	45	45	55	55	55	65	65	65	75	75	75
-25	22,00	11,34	1,94	23,00	13,80	1,67	24,00	16,26	1,48	—	—	—	—	—	—	—	—	—
-20	23,00	10,60	2,17	25,00	12,90	1,94	25,00	15,20	1,64	25,00	17,50	1,43	On request			—	—	—
-15	25,00	9,80	2,55	25,00	11,80	2,12	25,00	13,80	1,81	25,00	15,80	1,58	24,00	13,25	1,81	—	—	—
-7	25,00	7,60	3,29	25,00	10,60	2,36	25,00	13,60	1,84	25,00	13,90	1,80	25,00	14,10	1,77	—	—	—
2	25,00	6,85	3,65	25,00	8,93	2,80	25,00	11,01	2,27	25,00	12,70	1,97	25,00	13,70	1,82	—	—	—
7	25,00	3,89	6,43	25,00	5,55	4,50	25,00	7,21	3,47	25,00	8,33	3,00	25,00	11,60	2,16	—	—	—
25	25,00	3,09	8,09	25,00	3,42	7,31	25,00	3,75	6,67	25,00	4,08	6,13	25,00	5,18	4,83	25,00	9,60	2,60

**WH-WXG30ME8**

Tamb	HC	IP	COP	HC	IP	COP	HC	IP	COP	HC	IP	COP	HC	IP	COP	HC	IP	COP
LWC	25	25	25	35	35	35	45	45	45	55	55	55	65	65	65	75	75	75
-25	22,00	11,34	1,94	23,00	13,80	1,67	24,00	16,26	1,48	—	—	—	—	—	—	—	—	—
-20	23,00	10,60	2,17	25,00	12,90	1,94	25,00	15,20	1,64	25,00	17,50	1,43	On request			—	—	—
-15	27,00	13,43	2,01	30,00	15,50	1,94	30,00	17,57	1,71	30,00	19,64	1,53	25,00	14,61	1,71	—	—	—
-7	29,00	9,70	2,99	30,00	12,90	2,33	30,00	16,10	1,86	30,00	19,30	1,55	30,00	17,10	1,75	—	—	—
2	30,00	10,10	2,97	30,00	12,00	2,50	30,00	13,90	2,16	30,00	15,40	1,95	30,00	16,70	1,80	—	—	—
7	30,00	4,88	6,15	30,00	6,82	4,40	30,00	8,76	3,42	30,00	10,00	3,00	30,00	14,00	2,14	—	—	—
25	30,00	4,33	6,93	30,00	4,60	6,52	30,00	4,87	6,16	30,00	5,14	5,84	30,00	6,49	4,62	25,00	9,60	2,60

**Big Aquarea T-CAP Hydraulic Stand-alone M Series Three phase - R290**

**WH-WXG20ME8**

Tamb	CC	IP	EER	CC	IP	EER	CC	IP	EER
LWC	7	7	7	14	14	14	18	18	18
16	20,00	3,22	6,21	20,00	3,10	6,45	20,00	2,99	6,69
25	20,00	4,65	4,30	20,00	4,01	4,99	20,00	3,38	5,92
35	20,00	6,62	3,02	20,00	5,40	3,70	20,00	4,18	4,78
43	20,00	9,06	2,21	20,00	7,37	2,71	20,00	5,68	3,52

**WH-WXG25ME8**

Tamb	CC	IP	EER	CC	IP	EER	CC	IP	EER
LWC	7	7	7	14	14	14	18	18	18
16	25,00	4,56	5,48	25,00	4,32	5,79	25,00	4,09	6,11
25	25,00	6,35	3,94	25,00	5,45	4,59	25,00	4,57	5,47
35	25,00	8,74	2,86	25,00	7,17	3,49	25,00	5,59	4,47
43	21,80	9,44	2,31	23,40	8,63	2,71	25,00	7,54	3,32

**WH-WXG30ME8**

Tamb	CC	IP	EER	CC	IP	EER	CC	IP	EER
LWC	7	7	7	14	14	14	18	18	18
16	28,00	5,14	5,45	29,00	5,19	5,59	30,00	5,23	5,74
25	28,00	6,84	4,09	29,00	6,38	4,55	30,00	5,92	5,07
35	26,00	9,70	2,68	28,00	8,51	3,29	30,00	7,32	4,10
43	21,80	9,44	2,31	25,90	9,60	2,70	30,00	9,76	3,07

Tamb: Ambient Temperature (°C). LWC: Leaving Water Condenser Temperature (°C). HC: Heating Capacity (kW). CC: Cooling Capacity (kW). IP: Input Power (kW). This data is measured by Panasonic in accordance with EN 14511-2 standard. This data is for reference purpose only, and does not guarantee the performance. \* Data to be confirmed.

# Heating and cooling capacity tables

Based on outlet temperature and outside temperature.

## Aquarea T-CAP Mono-bloc J Series Single phase / Three phase - MXC · R32

WH-MXC09J3E5																
Tamb	HC	IP	COP	HC	IP	COP	HC	IP	COP	HC	IP	COP	HC	IP	COP	
LWC	25	25	25	35	35	35	45	45	45	55	55	55	60	60	60	
-20	9,00	3,44	2,62	9,00	3,95	2,28	9,00	4,65	1,94	7,90	5,58	1,42	—	—	—	
-15	9,00	2,98	3,02	9,00	3,41	2,64	9,00	4,04	2,23	9,00	4,83	1,86	8,70	5,37	1,62	
-7	10,50	2,72	3,86	9,00	2,92	3,08	9,00	3,54	2,54	9,00	4,24	2,12	9,00	4,62	1,95	
2	10,80	2,14	5,05	9,00	2,36	3,81	9,00	2,91	3,09	9,00	3,55	2,54	9,00	4,05	2,22	
7	9,00	1,38	6,52	9,00	1,77	5,08	9,00	2,37	3,80	9,00	2,92	3,08	9,00	3,29	2,74	
25	9,00	0,77	11,69	9,00	1,00	9,00	10,00	1,67	5,99	10,00	2,28	4,39	11,00	2,86	3,85	
WH-MXC12J6E5																
Tamb	HC	IP	COP	HC	IP	COP	HC	IP	COP	HC	IP	COP	HC	IP	COP	
LWC	25	25	25	35	35	35	45	45	45	55	55	55	60	60	60	
-20	12,00	5,02	2,39	12,00	5,80	2,07	11,00	5,95	1,85	10,00	6,50	1,54	—	—	—	
-15	12,00	4,14	2,90	12,00	4,83	2,48	11,00	5,20	2,12	10,50	6,00	1,75	8,90	6,30	1,41	
-7	13,50	4,30	3,14	12,00	4,25	2,82	12,00	5,02	2,39	12,00	6,00	2,00	11,00	6,30	1,75	
2	14,50	3,23	4,49	12,00	3,40	3,53	12,00	4,20	2,86	12,00	4,95	2,42	12,00	5,77	2,08	
7	12,00	2,00	6,00	12,00	2,50	4,80	12,00	3,24	3,70	12,00	3,94	3,05	12,00	4,52	2,65	
25	12,00	1,20	10,00	12,00	1,49	8,05	12,00	2,10	5,71	12,00	2,75	4,36	12,00	3,11	3,86	
WH-MXC09J3E8																
Tamb	HC	IP	COP	HC	IP	COP	HC	IP	COP	HC	IP	COP	HC	IP	COP	
LWC	25	25	25	35	35	35	45	45	45	55	55	55	60	60	60	
-20	9,00	3,44	2,62	9,00	3,95	2,28	9,00	4,65	1,94	7,90	5,58	1,42	—	—	—	
-15	9,00	2,98	3,02	9,00	3,41	2,64	9,00	4,04	2,23	9,00	4,83	1,86	8,70	5,37	1,62	
-7	10,50	2,72	3,86	9,00	2,92	3,08	9,00	3,54	2,54	9,00	4,24	2,12	9,00	4,62	1,95	
2	10,80	2,14	5,05	9,00	2,36	3,81	9,00	2,91	3,09	9,00	3,55	2,54	9,00	4,05	2,22	
7	9,00	1,38	6,52	9,00	1,77	5,08	9,00	2,37	3,80	9,00	2,92	3,08	9,00	3,29	2,74	
25	9,00	0,77	11,69	9,00	1,00	9,00	10,00	1,67	5,99	10,00	2,28	4,39	11,00	2,86	3,85	
WH-MXC12J9E8																
Tamb	HC	IP	COP	HC	IP	COP	HC	IP	COP	HC	IP	COP	HC	IP	COP	
LWC	25	25	25	35	35	35	45	45	45	55	55	55	60	60	60	
-20	12,00	5,02	2,39	12,00	5,80	2,07	10,50	5,75	1,83	9,20	5,80	1,59	—	—	—	
-15	12,00	4,14	2,90	12,00	4,83	2,48	12,00	5,67	2,12	11,10	6,35	1,75	8,70	6,20	1,40	
-7	13,50	4,30	3,14	12,00	4,25	2,82	12,00	5,02	2,39	12,00	6,00	2,00	11,00	6,30	1,75	
2	14,50	3,23	4,49	12,00	3,40	3,53	12,00	4,20	2,86	12,00	4,95	2,42	12,00	5,77	2,08	
7	12,00	2,00	6,00	12,00	2,50	4,80	12,00	3,24	3,70	12,00	3,94	3,05	12,00	4,52	2,65	
25	12,00	1,20	10,00	12,00	1,49	8,05	12,00	2,10	5,71	12,00	2,75	4,36	12,00	3,11	3,86	
WH-MXC16J9E8																
Tamb	HC	IP	COP	HC	IP	COP	HC	IP	COP	HC	IP	COP	HC	IP	COP	
LWC	25	25	25	35	35	35	45	45	45	55	55	55	60	60	60	
-20	16,00	7,40	2,16	16,00	8,40	1,90	16,00	10,00	1,60	14,00	10,30	1,36	—	—	—	
-15	15,30	6,10	2,51	16,00	6,91	2,32	16,00	8,44	1,90	16,00	9,97	1,60	14,00	10,60	1,32	
-7	19,00	6,60	2,88	16,00	6,70	2,39	16,00	7,85	2,04	16,00	9,33	1,71	15,00	9,70	1,55	
2	20,60	5,35	3,85	16,00	5,16	3,10	16,00	6,40	2,50	16,00	7,72	2,07	16,00	9,20	1,74	
7	16,00	2,80	5,71	16,00	3,54	4,52	16,00	4,55	3,52	16,00	5,60	2,86	15,60	6,50	2,40	
25	16,00	1,55	10,32	16,00	2,30	6,96	16,00	3,20	5,00	16,00	4,00	4,00	15,50	4,50	3,44	

## Aquarea T-CAP Mono-bloc J Series Single phase / Three phase - MXC · R32

Outdoor		WH-MXC09J3E5									WH-MXC12J6E5																	
Tamb	CC	IP	EER	CC	IP	EER	CC	IP	EER	CC	IP	EER	CC	IP	EER	CC	IP	EER										
LWC	7	7	7	14	14	14	18	18	18	7	7	7	14	14	14	18	18	18										
16	9,00	1,61	5,59	11,00	1,49	7,38	11,40	1,30	8,77	11,40	2,10	5,43	13,60	2,09	6,51	15,00	2,06	7,28										
25	9,00	2,00	4,50	12,60	2,38	5,29	10,50	1,54	6,82	12,00	2,87	4,18	15,70	3,60	4,36	14,00	2,56	5,47										
35	9,00	2,83	3,18	10,90	2,98	3,66	9,00	1,95	4,62	12,00	4,14	2,90	13,60	4,35	3,13	12,00	3,04	3,95										
43	7,20	3,26	2,21	8,70	3,23	2,69	7,30	2,43	3,00	10,30	4,89	2,11	11,80	4,98	2,37	10,40	3,72	2,80										
Outdoor		WH-MXC09J3E8									WH-MXC12J9E8									WH-MXC16J9E8								
Tamb	CC	IP	EER	CC	IP	EER	CC	IP	EER	CC	IP	EER	CC	IP	EER	CC	IP	EER	CC	IP	EER	CC	IP	EER				
LWC	7	7	7	14	14	14	18	18	18	7	7	7	14	14	14	18	18	18	7	7	7	14	14	14	18	18	18	
16	9,00	1,66	5,42	11,00	1,54	7,14	11,40	1,35	8,44	11,40	2,15	5,30	13,60	2,14	6,36	15,00	2,15	6,98	15,00	3,15	4,76	19,00	3,35	5,67	19,00	3,00	6,33	
25	9,00	2,06	4,37	12,60	2,45	5,14	10,50	1,60	6,56	12,00	2,93	4,10	15,70	3,68	4,27	14,00	2,66	5,26	15,00	4,00	3,75	18,00	4,00	4,50	18,00	3,50	5,14	
35	9,00	2,91	3,09	10,90	3,07	3,55	9,00	2,02	4,46	12,00	4,23	2,84	13,60	4,44	3,06	12,00	3,17	3,79	14,50	5,11	2,84	14,50	4,20	3,45	16,00	4,27	3,75	
43	7,20	3,36	2,14	8,70	3,33	2,61	7,30	2,53	2,89	10,30	5,00	2,06	11,80	5,09	2,32	10,40	3,87	2,69	9,50	4,40	2,16	11,50	4,40	2,61	12,50	4,30	2,91	

Tamb: Ambient Temperature (°C). LWC: Leaving Water Condenser Temperature (°C). HC: Heating Capacity (kW). CC: Cooling Capacity (kW). IP: Input Power (kW). This data is measured by Panasonic in accordance with EN 14511-2 standard. This data is for reference purpose only, and does not guarantee the performance.



## Aquarea EcoFlex. Single phase · R32

## CU-2WZ71YBE5

Tamb	HC	IP	COP	HC	IP	COP	HC	IP	COP	HC	IP	COP
LWC	25	25	25	35	35	35	45	45	45	55	55	55
-15	4,85	2,15	2,26	4,75	2,28	2,08	4,65	2,44	1,91	4,50	3,20	1,41
-7	5,40	1,70	3,18	5,60	1,97	2,84	5,60	2,40	2,33	5,30	2,78	1,91
2	6,50	1,77	3,67	6,70	2,06	3,25	6,60	2,45	2,69	6,00	2,89	2,08
7	8,16	1,63	5,01	8,00	1,90	4,21	8,00	2,30	3,48	8,00	2,85	2,81
12	8,22	1,28	6,42	8,00	1,52	5,26	8,00	2,00	4,00	8,00	2,60	3,08

## Aquarea High Performance Bi-bloc K Series Single phase · R32

## WH-UDZ03KE5

Tamb	HC	IP	COP	HC	IP	COP	HC	IP	COP	HC	IP	COP	HC	IP	COP
LWC	25	25	25	35	35	35	45	45	45	55	55	55	60	60	60
-20	2,50	1,11	2,25	2,52	1,31	1,92	2,24	1,59	1,41	2,12	1,80	1,18	—	—	—
-15	3,00	1,14	2,63	3,20	1,37	2,34	3,00	1,62	1,85	2,75	1,92	1,43	—	—	—
-7	2,99	0,91	3,29	3,30	1,18	2,80	3,25	1,47	2,21	3,20	1,79	1,79	3,00	1,88	1,60
2	2,92	0,69	4,23	3,20	0,88	3,64	3,20	1,13	2,83	3,20	1,46	2,19	3,15	1,67	1,89
7	3,09	0,49	6,31	3,20	0,60	5,33	3,20	0,84	3,81	3,20	1,14	2,81	2,95	1,22	2,42

## WH-UDZ05KE5

Tamb	HC	IP	COP	HC	IP	COP	HC	IP	COP	HC	IP	COP	HC	IP	COP
LWC	25	25	25	35	35	35	45	45	45	55	55	55	60	60	60
-20	—	—	—	4,05	1,95	2,08	3,76	2,20	1,71	3,39	2,48	1,37	—	—	—
-15	—	—	—	5,00	2,11	2,37	4,75	2,49	1,91	4,30	2,61	1,65	—	—	—
-7	—	—	—	5,00	1,79	2,79	5,00	2,14	2,34	5,00	2,65	1,89	4,68	2,71	1,73
2	—	—	—	5,00	1,40	3,57	5,00	1,79	2,79	5,00	2,18	2,29	4,80	2,40	2,00
7	—	—	—	5,00	0,98	5,10	5,00	1,31	3,82	5,00	1,65	3,03	4,58	1,90	2,41

## WH-UDZ07KE5

Tamb	HC	IP	COP	HC	IP	COP	HC	IP	COP	HC	IP	COP	HC	IP	COP
LWC	25	25	25	35	35	35	45	45	45	55	55	55	60	60	60
-20	—	—	—	4,45	2,12	2,10	4,23	2,48	1,71	3,90	2,85	1,37	—	—	—
-15	—	—	—	5,60	2,38	2,35	5,30	2,78	1,91	5,00	3,20	1,56	—	—	—
-7	—	—	—	5,75	1,95	2,95	5,65	2,30	2,46	5,35	2,70	1,98	4,98	2,90	1,72
2	—	—	—	6,85	2,00	3,43	6,75	2,40	2,81	6,25	2,80	2,23	6,18	2,91	2,12
7	—	—	—	7,00	1,44	4,86	7,00	1,92	3,65	7,00	2,40	2,92	6,86	2,73	2,51

## WH-UDZ09KE5

Tamb	HC	IP	COP	HC	IP	COP	HC	IP	COP	HC	IP	COP	HC	IP	COP
LWC	25	25	25	35	35	35	45	45	45	55	55	55	60	60	60
-20	—	—	—	4,95	2,43	2,04	4,58	2,70	1,70	4,04	3,00	1,35	—	—	—
-15	—	—	—	7,40	3,20	2,31	6,45	3,28	1,97	5,40	3,42	1,58	—	—	—
-7	—	—	—	6,25	2,20	2,84	6,10	2,68	2,28	5,90	3,06	1,93	5,65	3,24	1,74
2	—	—	—	7,00	2,06	3,40	6,85	2,50	2,74	6,30	2,89	2,18	7,26	3,31	2,19
7	—	—	—	9,00	1,98	4,55	9,00	2,58	3,49	8,90	3,04	2,93	8,60	3,42	2,51

## WH-UDZ12KE5

Tamb	HC	IP	COP	HC	IP	COP	HC	IP	COP	HC	IP	COP	HC	IP	COP
LWC	25	25	25	35	35	35	45	45	45	55	55	55	60	60	60
-20	—	—	—	8,80	4,42	1,99	8,00	4,95	1,62	7,00	5,65	1,24	—	—	—
-15	—	—	—	9,10	3,70	2,46	8,20	4,00	2,05	7,20	4,21	1,71	—	—	—
-7	—	—	—	10,10	3,69	2,74	9,30	4,29	2,17	8,40	4,27	1,97	7,30	4,40	1,66
2	—	—	—	11,50	3,34	3,44	10,70	3,78	2,83	9,20	4,09	2,25	8,20	4,40	1,86
7	—	—	—	12,10	2,53	4,78	12,00	3,38	3,55	12,00	4,06	2,96	10,20	4,26	2,39

Tamb: Ambient Temperature (°C). LWC: Leaving Water Condenser Temperature (°C). HC: Heating Capacity (kW). CC: Cooling Capacity (kW). IP: Input Power (kW). This data is measured by Panasonic in accordance with EN 14511-2 standard. This data is for reference purpose only, and does not guarantee the performance.

# Heating and cooling capacity tables

Based on outlet temperature and outside temperature.

## Aquarea High Performance Bi-bloc K Series Single phase - R32

### WH-UDZ03KE5

Tamb	CC	IP	EER	CC	IP	EER	CC	IP	EER
LWC	7	7	7	14	14	14	18	18	18
16	3,56	0,57	6,25	4,32	0,55	7,85	3,47	0,41	8,46
25	3,29	0,73	4,51	4,06	0,72	5,64	3,27	0,52	6,29
35	3,20	0,91	3,52	3,56	0,93	3,83	3,20	0,68	4,71
43	2,68	1,06	2,53	3,34	1,09	3,06	2,79	0,82	3,40

### WH-UDZ05KE5

Tamb	CC	IP	EER	CC	IP	EER	CC	IP	EER
LWC	7	7	7	14	14	14	18	18	18
25	5,47	1,37	3,99	6,62	1,39	4,76	5,54	0,80	6,93
35	5,00	1,64	3,05	6,69	1,76	3,80	5,00	1,02	4,90
43	4,18	1,83	2,28	5,54	1,84	3,01	4,45	1,27	3,50

### WH-UDZ07KE5

Tamb	CC	IP	EER	CC	IP	EER	CC	IP	EER
LWC	7	7	7	14	14	14	18	18	18
25	6,32	1,72	3,67	8,16	1,93	4,23	6,63	1,12	5,92
35	6,70	2,21	3,03	8,19	2,42	3,38	6,70	1,42	4,72
43	5,72	2,62	2,18	7,47	2,80	2,67	6,15	1,78	3,46

### WH-UDZ09KE5

Tamb	CC	IP	EER	CC	IP	EER	CC	IP	EER
LWC	7	7	7	14	14	14	18	18	18
25	8,31	2,50	3,32	10,43	2,67	3,91	8,85	1,72	5,15
35	8,20	3,02	2,72	10,28	3,25	3,16	9,00	2,15	4,19
43	5,00	2,15	2,33	6,38	2,15	2,97	7,02	2,14	3,28

### WH-UDZ12KE5

Tamb	CC	IP	EER	CC	IP	EER	CC	IP	EER
LWC	7	7	7	14	14	14	18	18	18
25	10,20	3,62	2,82	12,00	3,70	3,24	10,80	2,53	4,27
35	10,70	4,00	2,68	10,70	4,54	2,36	10,70	2,73	3,92
43	6,10	3,55	1,72	7,20	3,56	2,02	8,00	3,55	2,25

Tamb: Ambient Temperature (°C). LWC: Leaving Water Condenser Temperature (°C). HC: Heating Capacity (kW). CC: Cooling Capacity (kW). IP: Input Power (kW).  
This data is measured by Panasonic in accordance with EN 14511-2 standard. This data is for reference purpose only, and does not guarantee the performance.

**Aquarea T-CAP Bi-bloc K Series Single phase / Three phase · R32**

WH-UXZ09KE5												
Tamb	HC	IP	COP	HC	IP	COP	HC	IP	COP	HC	IP	COP
LWC	35	35	35	45	45	45	55	55	55	60	60	60
-20	8,80	4,79	1,84	8,80	5,30	1,66	8,55	5,90	1,45	—	—	—
-15	9,00	3,45	2,61	9,00	4,30	2,09	9,00	4,95	1,82	—	—	—
-7	9,00	3,00	3,00	9,00	3,82	2,36	9,00	4,28	2,10	9,00	4,72	1,91
2	9,00	2,44	3,69	9,00	3,05	2,95	9,00	3,90	2,31	9,00	4,05	2,22
7	9,00	1,79	5,03	9,00	2,42	3,72	9,00	2,93	3,07	9,00	3,43	2,62
25	7,95	1,20	6,63	9,00	1,56	5,77	11,30	3,13	3,61	11,00	2,86	3,85

WH-UXZ12KE5												
Tamb	HC	IP	COP	HC	IP	COP	HC	IP	COP	HC	IP	COP
LWC	35	35	35	45	45	45	55	55	55	60	60	60
-20	11,50	6,05	1,90	10,20	6,02	1,69	8,70	6,00	1,45	—	—	—
-15	12,00	4,90	2,45	11,00	5,38	2,04	10,50	6,20	1,69	—	—	—
-7	12,00	4,41	2,72	12,00	5,54	2,17	12,00	6,00	2,00	11,00	6,30	1,75
2	12,00	3,49	3,44	12,00	4,25	2,82	12,00	5,24	2,29	12,00	5,77	2,08
7	12,10	2,50	4,84	12,10	3,38	3,58	12,10	3,98	3,04	12,00	4,52	2,65
25	10,90	1,61	6,77	10,87	2,44	4,45	11,30	3,13	3,61	12,00	3,11	3,86

WH-UXZ09KE8												
Tamb	HC	IP	COP	HC	IP	COP	HC	IP	COP	HC	IP	COP
LWC	35	35	35	45	45	45	55	55	55	60	60	60
-20	8,80	4,79	1,84	8,80	5,30	1,66	8,55	5,90	1,45	—	—	—
-15	9,00	3,45	2,61	9,00	4,30	2,09	9,00	4,95	1,82	—	—	—
-7	9,00	3,00	3,00	9,00	3,82	2,36	9,00	4,28	2,10	9,00	4,72	1,91
2	9,00	2,44	3,69	9,00	3,05	2,95	9,00	3,90	2,31	9,00	4,05	2,22
7	9,00	1,79	5,03	9,00	2,42	3,72	9,00	2,93	3,07	9,00	3,43	2,62
25	7,95	1,20	6,63	9,00	1,56	5,77	11,30	3,13	3,61	11,00	2,86	3,85

WH-UXZ12KE8												
Tamb	HC	IP	COP	HC	IP	COP	HC	IP	COP	HC	IP	COP
LWC	35	35	35	45	45	45	55	55	55	60	60	60
-20	11,50	6,05	1,90	10,20	6,02	1,69	8,70	6,00	1,45	—	—	—
-15	12,00	4,90	2,45	11,00	5,38	2,04	10,50	6,20	1,69	—	—	—
-7	12,00	4,41	2,72	12,00	5,54	2,17	12,00	5,24	2,29	11,80	6,59	1,79
2	12,00	3,49	3,44	12,00	4,25	2,82	12,00	5,24	2,29	12,00	5,77	2,08
7	12,10	2,50	4,84	12,10	3,38	3,58	12,10	3,98	3,04	12,00	4,52	2,65
25	10,90	1,61	6,77	10,87	2,44	4,45	11,30	3,13	3,61	12,00	3,11	3,86

WH-UXZ16KE8												
Tamb	HC	IP	COP	HC	IP	COP	HC	IP	COP	HC	IP	COP
LWC	35	35	35	45	45	45	55	55	55	60	60	60
-20	16,00	8,20	1,95	15,00	9,00	1,67	12,00	9,30	1,29	—	—	—
-15	16,00	6,91	2,32	16,00	8,44	1,90	16,00	9,97	1,60	—	—	—
-7	16,00	6,70	2,39	16,00	7,85	2,04	16,00	9,33	1,71	15,00	9,70	1,55
2	16,00	5,16	3,10	16,00	6,40	2,50	16,00	7,72	2,07	16,00	9,20	1,74
7	16,00	3,65	4,38	16,00	4,72	3,39	16,00	5,88	2,72	15,20	5,90	2,58
25	16,00	2,30	6,96	16,00	3,20	5,00	16,00	4,00	4,00	14,50	4,30	3,37

**Aquarea T-CAP Bi-bloc K Series Single phase / Three phase · R32**

Outdoor	WH-UXZ09KE5									WH-UXZ12KE5																	
	Tamb	CC	IP	EER	CC	IP	EER	CC	IP	EER	CC	IP	EER	CC	IP	EER	CC	IP	EER								
LWC	7	7	7	14	14	14	18	18	18	7	7	7	14	14	14	18	18	18	7	7	7	14	14	14	18	18	18
25	8,98	2,37	3,79	10,60	2,41	4,40	9,00	1,57	5,73	11,10	3,35	3,31	13,03	3,43	3,80	11,63	2,34	4,97	15,00	4,00	3,75	17,00	4,05	17,00	3,40	5,00	
35	8,80	2,83	3,11	9,07	3,01	3,01	8,80	1,90	4,63	10,70	4,00	2,68	11,42	4,20	2,72	10,70	2,73	3,92	13,40	5,08	2,64	15,50	5,30	2,92	13,40	5,08	2,64
43	6,48	3,27	1,98	7,65	3,27	2,34	6,68	2,46	2,72	6,62	3,29	2,01	7,89	3,30	2,39	8,68	3,28	2,65	8,80	4,20	2,10	10,50	4,30	2,44	11,50	4,20	2,74

Outdoor	WH-UXZ09KE8									WH-UXZ12KE8									WH-UXZ16KE8								
	Tamb	CC	IP	EER	CC	IP	EER	CC	IP	EER	CC	IP	EER	CC	IP	EER	CC	IP	EER	CC	IP	EER	CC	IP	EER	CC	IP
LWC	7	7	7	14	14	14	18	18	18	7	7	7	14	14	14	18	18	18	7	7	7	14	14	14	18	18	18
25	8,98	2,37	3,79	10,60	2,41	4,40	9,00	1,57	5,73	11,10	3,35	3,31	13,03	3,43	3,80	11,63	2,34	4,97	15,00	4,00	3,75	17,00	4,20	4,05	17,00	3,40	5,00
35	8,80	2,83	3,11	9,07	3,01	3,01	8,80	1,90	4,63	10,70	4,00	2,68	11,42	4,20	2,72	10,70	2,73	3,92	13,40	5,08	2,64	15,50	5,30	2,92	13,40	5,08	2,64
43	6,48	3,27	1,98	7,65	3,27	2,34	6,68	2,46	2,72	6,62	3,29	2,01	7,89	3,30	2,39	8,68	3,28	2,65	8,80	4,20	2,10	10,50	4,30	2,44	11,50	4,20	2,74

Tamb: Ambient Temperature (°C). LWC: Leaving Water Condenser Temperature (°C). HC: Heating Capacity (kW). CC: Cooling Capacity (kW). IP: Input Power (kW). This data is measured by Panasonic in accordance with EN 14511-2 standard. This data is for reference purpose only, and does not guarantee the performance.

# Heating and cooling capacity tables

Based on outlet temperature and outside temperature.

## Aquarea T-CAP Bi-bloc H Series Three phase. Super Quiet outdoor unit - SQC - R410A

### WH-UQ09HE8

Tamb	HC	IP	COP	HC	IP	COP	HC	IP	COP	HC	IP	COP	HC	IP	COP	HC	IP	COP
LWC	30	30	30	35	35	35	40	40	40	45	45	45	50	50	50	55	55	55
-15	9,00	3,24	2,78	9,00	3,51	2,56	9,00	3,91	2,30	9,00	4,30	2,09	9,00	4,73	1,90	9,00	5,16	1,74
-7	9,00	2,71	3,32	9,00	3,16	2,85	9,00	3,62	2,49	9,00	4,07	2,21	9,00	4,27	2,11	9,00	4,46	2,02
2	9,00	2,36	3,81	9,00	2,51	3,59	9,00	2,78	3,24	9,00	3,05	2,95	9,00	3,56	2,53	9,00	4,07	2,21
7	9,00	1,64	5,49	9,00	1,86	4,84	9,00	2,16	4,17	9,00	2,46	3,66	9,00	2,76	3,26	9,00	3,06	2,94
25	13,60	1,50	9,07	13,60	1,71	7,95	13,20	1,93	6,84	12,80	2,14	5,98	12,00	2,41	4,98	11,20	2,67	4,19

### WH-UQ12HE8

Tamb	HC	IP	COP	HC	IP	COP	HC	IP	COP	HC	IP	COP	HC	IP	COP	HC	IP	COP
LWC	30	30	30	35	35	35	40	40	40	45	45	45	50	50	50	55	55	55
-15	12,00	4,75	2,53	12,00	4,96	2,42	12,00	5,41	2,22	12,00	5,86	2,05	11,80	6,24	1,89	11,60	6,62	1,75
-7	12,00	3,85	3,12	12,00	4,41	2,72	12,00	4,98	2,41	12,00	5,54	2,17	12,00	5,90	2,03	12,00	6,26	1,92
2	12,00	3,19	3,76	12,00	3,49	3,44	12,00	3,87	3,10	12,00	4,25	2,82	12,00	4,86	2,47	12,00	5,47	2,19
7	12,00	2,18	5,50	12,00	2,53	4,74	12,00	2,96	4,05	12,00	3,39	3,54	12,00	3,78	3,17	12,00	4,16	2,88
25	13,60	1,55	8,77	13,60	1,76	7,73	13,40	2,10	6,38	13,20	2,43	5,43	12,60	2,66	4,74	12,00	2,89	4,15

### WH-UQ16HE8

Tamb	HC	IP	COP	HC	IP	COP	HC	IP	COP	HC	IP	COP	HC	IP	COP	HC	IP	COP
LWC	30	30	30	35	35	35	40	40	40	45	45	45	50	50	50	55	55	55
-15	16,00	6,30	2,54	16,00	6,89	2,32	16,00	7,45	2,15	16,00	8,10	1,98	16,00	8,48	1,89	15,20	8,96	1,70
-7	16,00	5,85	2,74	16,00	6,42	2,49	16,00	7,00	2,29	16,00	7,57	2,11	16,00	8,10	1,98	16,00	8,62	1,86
2	16,00	4,67	3,43	16,00	5,21	3,07	16,00	5,74	2,79	16,00	6,31	2,54	16,00	6,90	2,32	16,00	7,50	2,13
7	16,00	3,35	4,78	16,00	3,74	4,28	16,00	4,30	3,72	16,00	4,80	3,33	16,00	5,43	2,95	16,00	5,91	2,71
16	16,00	2,59	6,18	16,00	3,18	5,03	16,00	3,71	4,31	16,00	4,27	3,75	16,00	4,86	3,29	16,00	5,22	3,07
25	16,00	2,02	7,92	16,00	2,58	6,20	16,00	2,91	5,50	16,00	3,36	4,76	16,00	3,74	4,28	16,00	4,00	4,00

## Aquarea T-CAP Bi-bloc H Series Three phase. Super Quiet outdoor unit - SQC - R410A

### WH-UQ09HE8

Tamb	CC	IP	EER	CC	IP	EER
LWC	7	7	7	18	18	18
18	7,00	1,36	5,15	—	—	—
25	7,65	1,91	4,01	—	—	—
35	7,00	2,21	3,17	—	—	—
43	6,25	2,66	2,35	—	—	—

### WH-UQ12HE8

Tamb	CC	IP	EER	CC	IP	EER
LWC	7	7	7	18	18	18
18	7,50	1,41	5,32	—	—	—
25	8,90	2,16	4,12	—	—	—
35	10,00	3,56	2,81	—	—	—
43	8,00	3,01	2,66	—	—	—

### WH-UQ16HE8

Tamb	CC	IP	EER	CC	IP	EER
LWC	7	7	7	18	18	18
18	8,50	1,70	5,00	10,00	1,70	5,88
25	14,00	4,00	3,50	14,00	2,94	4,76
35	12,20	4,76	2,56	12,20	3,50	3,49
43	7,10	3,31	2,15	9,80	3,31	2,96

Tamb: Ambient Temperature [°C]. LWC: Leaving Water Condenser Temperature [°C]. HC: Heating Capacity [kW]. CC: Cooling Capacity [kW]. IP: Input Power [kW].  
This data is measured by Panasonic in accordance with EN 14511-2 standard. This data is for reference purpose only, and does not guarantee the performance.

# Examples of installations

**Aquarea H and J Series:  
Bivalent with buffer tank and mixing valve**

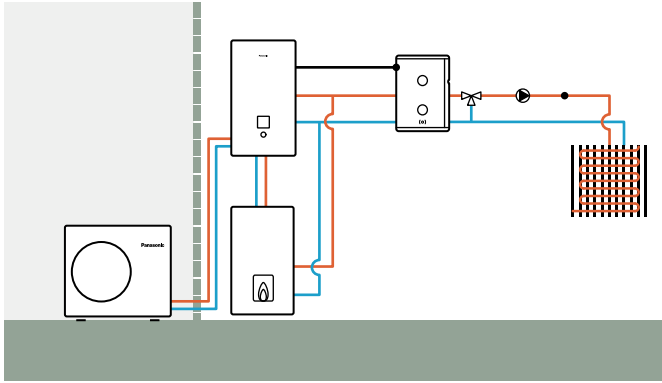

**Aquarea H and J Series:  
Buffer tank with solar and mixing valve**

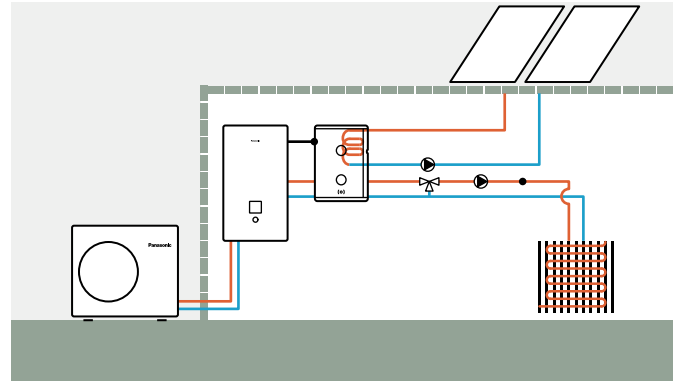

**Aquarea H and J Series:  
2 zones with external kit without buffer tank**

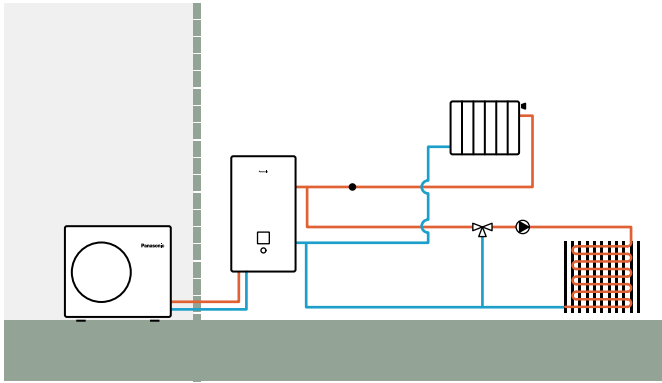

**Aquarea H and J Series:  
2 zones with external kit, buffer tank and swimming pool**

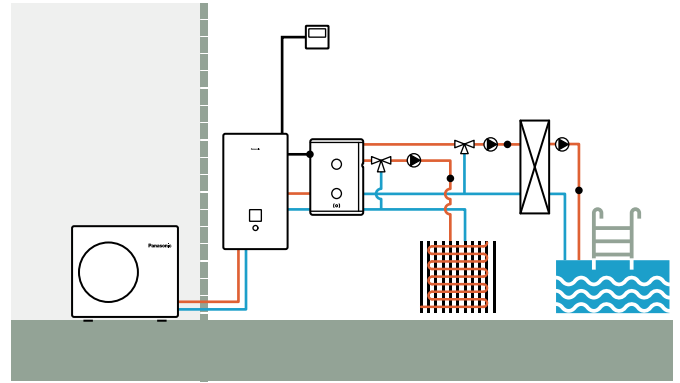

**Aquarea All in One H and J Series:  
2 zones with external kit, without buffer tank**

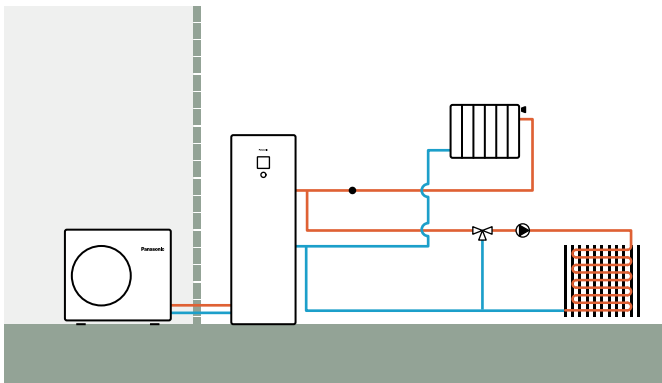

**Aquarea All in One 2 zones H and J Series:  
2 zones built-in, without buffer tank**

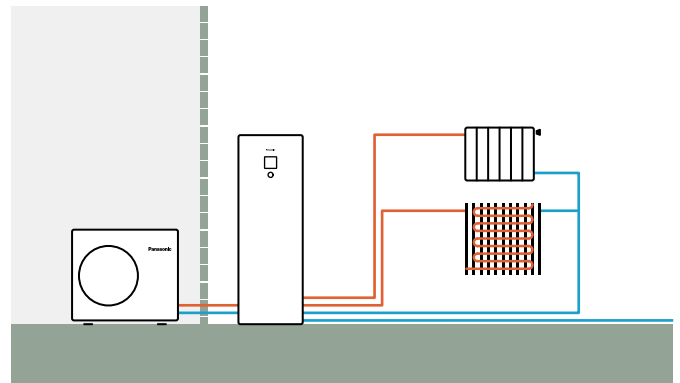



## Panasonic domestic air to air heat pump

Panasonic has developed a range of products designed for you, better than ever before. Above all, it is also a range for air conditioning professionals, such as yourself, thanks to its broad range of products which are capable of conditioning rooms of all sizes – always with optimal efficiency and incomparable ease of installation.





Highlighted features	→ 152
Bringing nature's balance indoors	→ 154
Etherea with nanoe™ X technology	→ 156
Heatcharge. Energy Charge System	→ 158
Wall-mounted TZ super-compact	→ 160
Super-compact units	→ 162
Floor console	→ 164
Power Heat Multi system	→ 166
Panasonic R2 rotary compressor	→ 168
R22 Renewal	→ 170
Panasonic Comfort Cloud App	→ 172
Voice Control	→ 174
Control and connectivity	→ 176
Domestic air conditioner R32 range	→ 178

### Wall-mounted

Heatcharge VZ · R32	→ 180
Etherea · R32	→ 181
TZ super-compact · R32	→ 182
BZ super-compact · R32	→ 183
UZ super-compact · R32	→ 184

### More options for your home

Floor console · R32	→ 185
Low static pressure hide-away · R32	→ 186
RAC Solo · R290 / R32	→ 194

### Multi split systems

Free Multi system	→ 190
Power Heat Multi system	→ 192
Multi wall TZ system	→ 193

Compare split solutions	→ 187
Single split feature overview	→ 196
Features explained	→ 197

Accessories and control	→ 198
-------------------------	-------

## Highlighted features

With innovative design, high efficiency and advanced technologies, such as the Panasonic Comfort Cloud App for smart control and nanoe™ X for indoor air quality improvement, the residential range has been designed with you and your clients in mind.





## Panasonic air conditioners provide more savings and more comfort.

We believe that going green shouldn't compromise on comfort.

Our super silent air conditioners guarantee clean indoor air for you and your family. For a cleaner living environment, the nanoe™ X helps improve the quality of the indoor air as well as your surroundings. Together, these breakthrough technologies embody Panasonic's Eco Clean Life Innovation - innovations that improve our environment whilst making life as comfortable as possible.

The iF Product Design Awards are among the most prestigious awards for product design excellence. Winning the award thanks to its highly intelligent functionality, the Panasonic Floor console is the ideal air-conditioning system for domestic and commercial applications.



### Energy saving



#### Natural refrigerant R290 with GWP 3.

Natural refrigerant R290 has low Global Warming Potential (GWP) of just 3, helping reduce CO<sub>2</sub> emissions and environmental impact.



#### Refrigerant R32.

Our heat pumps containing R32 refrigerant show a drastic reduction in the value of Global Warming Potential (GWP).



#### Exceptional seasonal cooling efficiency based on the ErP regulation.

Higher SEER ratings mean greater efficiency and year-round cooling savings!



#### Exceptional seasonal heating efficiency based on the ErP regulation.

Higher SCOP ratings mean greater efficiency and year-round heating savings!



#### Econavi. Sunlight sensor.

Sunlight Sensor technology can detect and reduce the waste of energy by optimising air conditioner operation according to room conditions. With just one touch of a button, you can save energy.



#### Inverter Plus system.

Inverter Plus system classification highlights Panasonic's highest performing systems.



#### Inverter.

The Inverter range provides greater efficiency and comfort. Provides more precise temperature control, without highs and lows, and keeps the ambient temperature constant with lower energy consumption and a significant reduction in noise and vibration levels.



#### Panasonic R2 rotary compressor.

Designed to withstand extreme conditions, it delivers high performance and efficiency.

### High performance and indoor air quality



#### nanoe™ X.

Technology with the benefits of hydroxyl radicals has the capacity to inhibit pollutants, viruses, and bacteria to clean and deodorise.



#### PM2,5 filter.

This filter can capture airborne particulate matter (PM2,5), including hazardous pollutants, as well as house dust and pollen.



#### Dust collection filter.

This filter collects and retains particles suspended in the air, resulting in cleaner air in the room.



#### Super Quiet.

With Super Quiet technology our devices are quieter than a library (30 dB(A)).



#### Inside cleaning.

This function works to dry-off to inside of indoor unit with nanoe™ X. It can inhibit certain adhered bacteria, viruses and mould up to 99% efficiency.



#### Mild Dry cooling.

Fine control helps prevent a rapid decrease in room humidity while maintaining the set temperature. Maintains an RH\* up to 10% higher than cooling operation (\*RH: Relative Humidity). Ideal when sleeping with the air conditioner on.



#### More comfort with Aerowings.

Panasonic's Aerowings feature incorporates two blades that concentrate the air flow to cool or heat in the shortest possible time by distributing the air evenly throughout the room.



#### Static pressure up to 7 mmAq.

Low static pressure hide-away with selectable static pressure up to 7 mmAq.



#### Filter included.

Hide-away with filter included.



#### Summer House.

This innovative function keeps the house at 8/10 or 8/15 °C to avoid freezing pipes during the winter. This function is beneficial for summer or weekend homes.



#### Down to -10 °C in cooling mode.

The air conditioner works in cooling mode when the outdoor temperature of -10 °C.



#### Down to -15 °C in heating mode.

The air conditioner works in heat pump mode when the outdoor temperature is as low as -15 °C.



#### R410A/R22 renewal.

The Panasonic renewal system allows good quality existing R410A or R22 pipe work to be re-used whilst installing high efficiency R32 systems.



#### 5 Years compressor warranty.

We guarantee the outdoor unit compressors in the entire range for five years.

### High connectivity



#### Domestic integration to S-Link - CZ-CAPRA1.

Can connect RAC range to S-Link. Full control is now possible.



#### Wi-Fi control.

The Panasonic Comfort Cloud App allows users to conveniently manage and monitor Panasonic residential heat pumps from a mobile device, anytime, anywhere.



#### BMS connectivity.

The communication port can be integrated into the indoor unit and provides easy connection to, and control of, your Panasonic air conditioner to your home or Building Management System.

# Bringing nature's balance indoors



## nanoe™ X, technology with the benefits of hydroxyl radicals.

Abundant in nature, hydroxyl radicals (also known as OH radicals) have the capacity to inhibit pollutants, viruses, and bacteria to clean and deodorise. nanoe™ X technology can bring these incredible benefits indoors so that hard surfaces, soft furnishings, and the indoor environment can be a cleaner and more pleasant place to be.



### What is unique about nanoe™ X?

**Effective on fabrics and surfaces.**

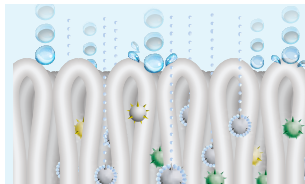

1 | At one billionth of a metre, nanoe™ X is much smaller than steam and can deeply penetrate cloth fabrics to deodorise.

**Longer lifespan.**



2 | Contained in tiny water particles, nanoe™ X has a long lifespan, which is about 600 seconds, to spread easily around the room.

**Huge quantity.**



3 | nanoe X Generator Mark 3 produces 48 trillion hydroxyl radicals per second. Greater amounts of hydroxyl radicals contained in nanoe™ X lead to higher performance on inhibition of pollutants.

**Maintenance-free.**



The image shows nanoe X Generator Mark 3.

4 | No service and maintenance required. nanoe™ X is a filter free solution that does not require maintenance, as its atomisation electrode is enveloped with water during its generation process and it is made with Titanium.

### 7 effects of nanoe™ X – Panasonic unique technology

**Deodorises**

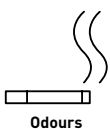

Odours

**Capacity to inhibit 5 types of pollutants**

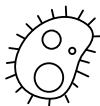

Bacteria and viruses

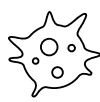

Mould

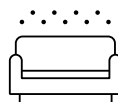

Allergens



Pollen



Hazardous substances



Skin and hair

\* Refer to <https://aircon.panasonic.eu> for more details and validation data.

### First nanoe™ device was developed by Panasonic in 2003

**Generator: nanoe™**

2003

480 billion hydroxyl radicals/sec

**Ion particle structure**

Hydroxyl radicals

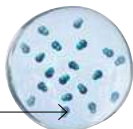

**Generator: nanoe™ X**

**Mark 1 - 2016**

4,8 trillion hydroxyl radicals/sec

10x times

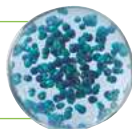

**Mark 2 - 2019**

9,6 trillion hydroxyl radicals/sec

20x times

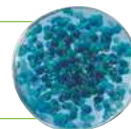

**Mark 3 - 2022**

48 trillion hydroxyl radicals/sec

100x times

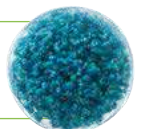

nanoe™ X, internationally-validated technology in testing facilities.

The effectiveness of nanoe™ X technology has been tested by 3rd party laboratories in Germany, France, Denmark, Japan and China.

The nanoe™ X performance varies depending on the room size, environment and usage and it may take several hours to reach the full effect. nanoe™ X is not medical device, local regulations on building design and sanitary recommendations must be followed. Test results conducted under controlled laboratory conditions. Performance of nanoe™ X might differ in real life environment.

	Tested contents	Generator	Result	Capacity	Time	Testing organisation	Report No.	
Airborne	Virus	Influenza (H1N1)	Mark 2	98,3% inhibited	30 m³	1,5 h	China Electronic Product Reliability and Environmental Testing Research Institute	J2003WT8888-00889
		Bacteriophage ΦX174	Mark 1	99,2% inhibited	Approx. 25 m³	6 h	Kitasato Research Center for Environmental Science	24_0300_1
	Bacteria	Staphylococcus aureus	Mark 1	99,7% inhibited	Approx. 25 m³	4 h	Kitasato Research Center for Environmental Science	24_0301_1
Adhering	Virus	SARS-CoV-2	Mark 1	91,4% inhibited	6,7 m³	8 h	Texcell (France)	1140-01 C3
		SARS-CoV-2	Mark 1	99,9% inhibited	45 L	2 h	Texcell (France)	1140-01 A1
		Bacteriophage ΦX174	Mark 1	99,8% inhibited	Approx. 25 m³	8 h	Japan Food Research Laboratories	13001265005-01
		Xenotropic murine leukemia virus	Mark 1	99,999% inhibited	45 L	6 h	Charles River Biopharmaceutical Services GmbH	—
		Coxsackie virus (CA16)	Mark 2	99,9%inhibited	30 m³	4 h	China Electronic Product Reliability and Environmental Testing Research Institute	J2002WT8888-00439
		Bacteriophage	Mark 3	98,81% inhibited	Approx. 139,3 m³	4 h	SGS Inc	SHES210901902584
	Bacteria	Staphylococcus aureus	Mark 1	99,9% inhibited	20 m³	8 h	Danish Technological Institute	868988
			Mark 3	99%inhibited	Approx. 24 m³	12 h	Panasonic Product Analysis Center	H21YA017-1
	Pollen	Ambrosia pollen	Mark 1	99,4% inhibited	20 m³	8 h	Danish Technological Institute	868988
			Mark 3	Odour intensity reduced by 2,4 levels	Approx. 23 m³	0,2 h	Panasonic Product Analysis Center	4AA33-160615-N04
	Odours	Cigarette smoke odour	Mark 3	Odour intensity reduced 1,7 levels	Approx. 139,3 m³	0,5 h	SGS Inc	SHES210901902478

Licensed in VDI 6022

Certification of a HVAC system under VDI 6022 guarantees that the system fulfills the market's strictest hygiene requirements.



VDI 6022 – Part 5 <sup>1)</sup> Certification.

Avoidance of allergenic exposure.

Inhibits a wide range of harmful bacteria, viruses, mould, pollen and allergens.



VDI 6022 – Part 1 <sup>1)</sup> & 1.1 <sup>2)</sup> Certification.

Ventilation and indoor-air quality.

Panasonic nanoe™ X technology improving indoor air quality.

1) Certification mark only valid for nanoe X Generator Mark 3. 2) Certification mark only valid for nanoe X Generator Mark 2 and Mark 3.

nanoe™ X: improving protection 24/7

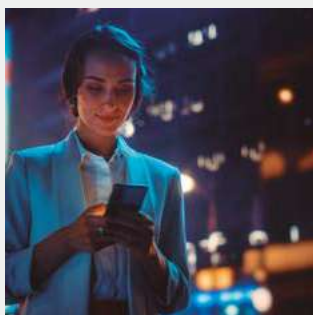

Acts to clean your air, so that the indoor environment can be a cleaner and more pleasant place to be all day long. nanoe™ X works together with heating or cooling function when you are at home and can work independently when you are away. Give the air conditioning the strength to increase the protection at home with nanoe™ X technology and convenient control via the Panasonic Comfort Cloud App.

Cleans the air when you are away.

Leave the nanoe™ mode ON to inhibit certain pollutants and deodorise before you return home.

Improves your environment when you are at home.

Enjoy a cleaner, comfortable space with loved ones.



Panasonic Heating & Cooling Solutions is incorporating nanoe™ technology in a wide range of equipment



Wall-mounted Etherea. Built-in nanoe X Generator Mark 3.



Floor console. Built-in nanoe X Generator Mark 1.



Wall-mounted TZ super-compact. Built-in nanoe X Generator Mark 1.



Wall-mounted Heatcharge VZ. Built-in nanoe™.

## Etherea with nanoe™ X technology

A smart solution to keep your home clean, comfortable and welcoming. The smart, Etherea comes with nanoe™ X technology with the benefits of hydroxyl radicals. With advanced control options, class-leading performance, a stylish design and intelligent features, Etherea is designed to make your home comfortable, clean and the ideal place to be.

—ETHEREA—

Available in 3 colors





Built-in nanoe X Generator Mark 3



BUILT-IN WI-FI

+ SEE PRODUCT SPECIFICATIONS

### 1 Air quality

- nanoe™ X technology with the benefits of hydroxyl radicals (Generator Mark 3)
- Acts to clean your air, so that the indoor environment can be a cleaner and more pleasant place to be all day long
- Cleaning and drying the indoor unit with nanoe™ X

### 2 Smart control

- Built-in Wi-Fi, now with easier and faster set-up
- Advanced smartphone control
- Compatible with Google Assistant and Amazon Alexa



### 3 High efficiency

- Top class energy efficiency up to A+++ in heating and cooling

### 4 Ultimate comfort

- Aerowings 2.0, end-to-end vanes enhance comfortable air flow
- Super Quiet ambient

### 5 Design

- Stylish, monolithic design available in graphite grey, silver and matt white
- Chassis and parts designed for easier installation and servicing
- High class, easy-to-use remote control with backlight



### nanoe™ X: Bringing nature's balance indoors

Etherea comes with nanoe X Generator Mark 3, the latest of the continuously evolving nanoe™ X technology. It has the largest amount of hydroxyl radicals in the history of nanoe™ - 48 trillion hydroxyl radicals per second, 100 times more than the traditional nanoe™. The increased number of hydroxyl radicals, which are the key to nanoe™ power, results in a higher level of performance.

Comparison of time required to inhibit 99% of cedar pollen.

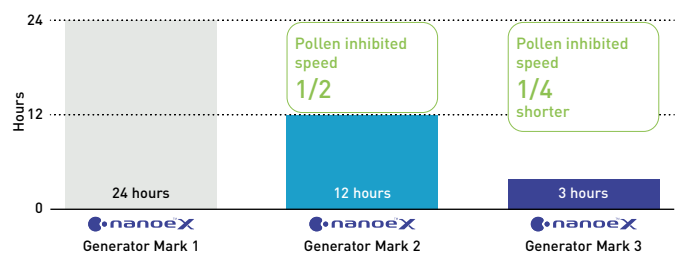

### Technology for the ultimate comfort

#### Introducing the Aerowings 2.0 to the Etherea range.

Panasonic's Aerowings technology consists of two independent flexible vanes that concentrate air flow to heat or cool a room in the shortest time possible and helps distribute air evenly throughout a room.

Thanks to the larger sub vane (72 mm), which is more than doubled in size than other conventional designs, the ability to lift air flow has been further improved.



Aerowings 2.0 has a shower cooling feature which allows air flow to be concentrated evenly towards the ceiling to achieve comfortable cooling across a room, showering gently down into a room rather than one area subject to a continuous icy blast.



For heating, Aerowings 2.0 releases a concentrated air flow downwards to achieve an effect similar to floor heating the air, which rises and fills the room.



### Inside cleaning

The inside cleaning operation acts to clean the inside of indoor unit. It uses nanoe™ X technology that can inhibit certain adhered bacteria, viruses, and mould on the filter, evaporator and air outlet and filter up to 99%. Cross flow fan is coated to prevent dust adhered on its surfaces and can be effective against certain bacteria and mould.

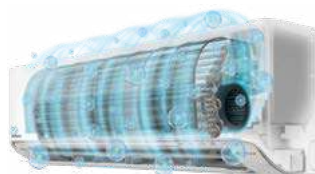

Without coating: Adhered dust.



With anti-static coating: Maintain cleanliness.

Proven prevents dust adhered 62,5%\* compare with non-coating.

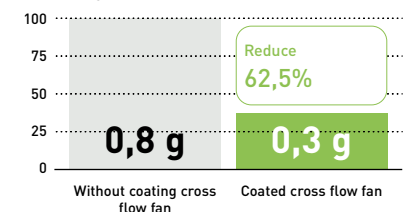

The amount of dust or mould may change depending on the usage frequency and environment.  
\* Based on Panasonic internal testing result.

## Heatcharge. Energy Charge System

heatcharge

Energy class A +++ and offers maximum comfort and energy savings. This powerful air heat pump is designed for commercial and residential climate that places extremely high demands on the heating system.





+ SEE PRODUCT SPECIFICATIONS

### 1 Powerful, reliable heating even at low ambient winter temperatures

When the air conditioner is operating, the compressor, which is the power supply of the unit, generates heat. Until now, this heat was released into the atmosphere. Panasonic has utilised this waste heat!

#### Constant heating.

Using stored heat provides stable heating with less drop in temperature. Even when heating operation stops during defrost operation, stored heat continues to constantly warm the room. This eliminates the previous discomfort due to the temperature dropping when heating temporarily stops to ensure stable air conditioner heating.

### 2 Panasonic's full line-up of A+++ heat pumps

In response to the Kyoto Protocol, the European Union set some challenging targets for the reduction in greenhouse-gas emissions. By the year 2020, across the member states, the EU wants to have achieved the following objectives:

- A 20% cut in greenhouse gas emissions (from 1990 base levels)
- The share of renewables in the energy mix to increase by 20%
- An overall reduction of 20% in energy consumption

### 3 Comfort and efficiency

- nanoe™ technology with the benefits of hydroxyl radicals
- Higher efficiency and comfort with Econavi sunlight detection and human activity detection
- Powerful air flow to quickly reach the desired temperature

#### Conventional. The room gradually becomes cold.

Defrost operation: About 11 to 15 min. Fall in room temperature: About 5 to 6 °C.

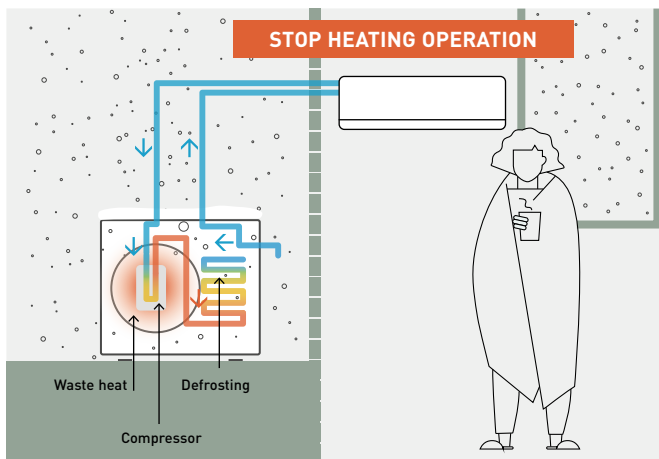

#### Heatcharge. The room is thoroughly warmed.

Defrost operation: About 5 to 6 min. Fall in room temperature: About 1 to 2 °C.

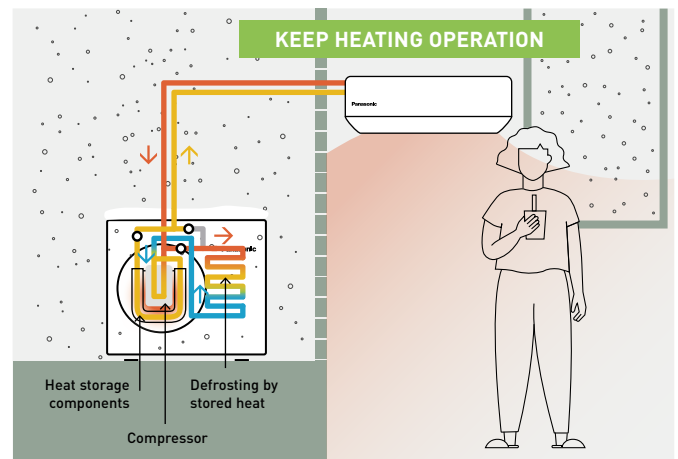

#### Conventional.

During operation, heat is generated inside the compressor.

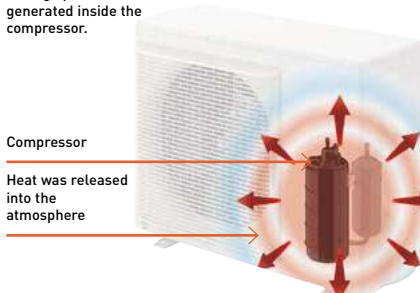

#### Heatcharge.

Heat generated by the compressor is stored inside and used to warm the refrigerant to efficiently increase heating power.

Waste heat is "charged" and used effectively



#### Heatcharge.

The compressor is wrapped and exhaust heat is used for charging.

Heatcharge tank. Waste heat from the compressor is stored.

Finless heat exchanger. Stored heat is converted to energy.

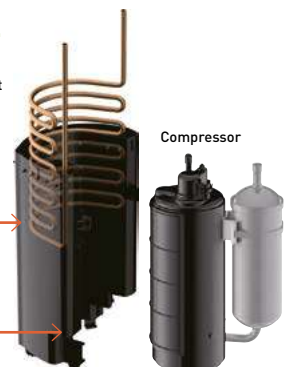

\* Defrost operation time and how low room temperature falls differ depending on the environment in which the unit is being used (how insulated and airtight the room is), operation conditions, and temperature conditions. Output air temperature falls during defrost operation. How low room temperature falls differs depending on the environment in which the unit is being used (how insulated and airtight the room is), operation conditions, and temperature conditions. In environments where a lot of frost accumulates, heating may stop during defrost operation.

## Wall-mounted TZ super-compact with nanoe™ X

Smart comfort and cleaner air in a compact unit.

TZ features nanoe™ X technology with the benefits of hydroxyl radicals for a cleaner and more comfortable indoor environment.







+ SEE PRODUCT SPECIFICATIONS

## 1 Air quality

- nanoe™ X technology with the benefits of hydroxyl radicals
- Acts to clean your air, so that the indoor environment can be a cleaner and more pleasant place to be all day long

## 2 Smart control

- Built-in Wi-Fi, now with easier and faster set-up
- Advanced smartphone control
- Compatible with Google Assistant and Amazon Alexa



## 3 Ultimate comfort

- Aerowings to control air draft direction
- Super Quiet ambient

## 4 Design

- Super-compact design, just 779 mm wide
- Chassis and parts designed for easier installation and servicing
- High class, easy-to-use remote control with backlight

### nanoe™ X: Bringing nature's balance indoors

Panasonic's nanoe™ X technology brings nature's detergent – hydroxyl radicals – indoors to help improve protection 24/7 against several types of pollutants can be inhibited such as certain types of bacteria, viruses, mould, allergens, pollen or hazardous substances.

The nanoe™ X performance varies depending on the room size, environment and usage and it may take several hours to reach the full effect (see page 155 for more detail). nanoe™ X is not medical device, local regulations on building design and sanitary recommendations must be followed.



### Super-compact design

The compact design of the indoor units have a width of just 779 mm. This allows for more installation possibilities, including the limited space above a door.

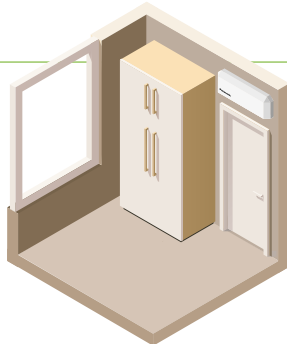

The easy-to-use remote controller features an ergonomic design with tapered rear housing for the most comfortable grip. The controller's intuitive design provides easy operation with five quick access keys for convenient use. The controller also has a minimalist design with the less frequently used keys concealed under a sliding cover.



### Aerowings

Panasonic's Aerowings feature incorporates two blades that concentrate air flow to cool you down in the shortest time possible. This also helps distribute cool air evenly throughout the room.

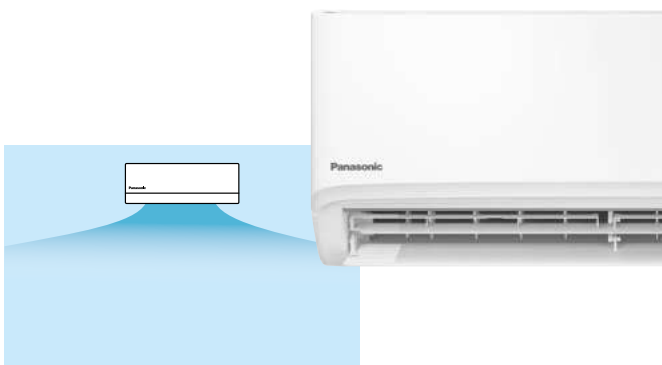

### Comfort that goes on and on with Shower Cooling.

When the Aerowings twin blades direct air towards the ceiling they create the Shower Cooling effect. This ensures cool air is evenly distributed throughout the room and you can stay comfortable without experiencing continuous direct cooling.

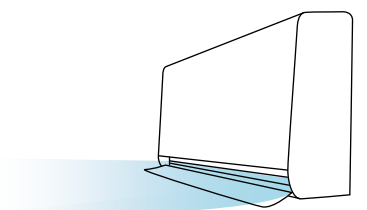

Panasonic Air Conditioners with Aerowings feature an indoor design with wider intake grille and super-high fan speed to produce bigger air flow.

## Wall-mounted indoor units, designed for simple installation and maintenance

The full range of wall-mounted indoor units has been carefully designed for simple, stress-free installation and ongoing maintenance.

\* Not applicable to VZ.





Feature available in Etherea, TZ, BZ, and UZ

## 1 Simple installation

Thanks to advanced improvements, installation time has been dramatically decreased. The models have been designed to provide more stability and strength for neat installation, with newly built-in support and convenient access to the drain hose, cabling inserts and larger space for secure installation.

## 2 Easy maintenance

Meticulously designed for both installer and user benefit, the unit features an easy to remove front grille for convenient access to the interior. The inner workings of the unit have also been redesigned to make maintenance quicker and easier. Electronics and wiring components are now on just one side of the unit to simplify maintenance.



### 1. Stronger installation plate.

The models feature a stronger, solid installation plate that provides more stability and strength. For uneven surfaces, there are 2 additional screws to ensure a neat and secure installation .

Installation plate: Strong and solid.

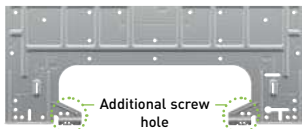

Screw holder for uneven surface (screws not provided).



### 2. One-piece front grille.

The model comes with a one-piece front grille design to make servicing easier. First, open the intake grille and remove the screws. Next, slide the three slider locks and remove the front grille.

One-piece front grille: Easy removal.



Slider locks: Easy to unlock / lock.

### 3. Built-in support holder.

The model features a built-in support holder, making installation easier and providing convenience and workspace improvements.

Convenient installation and serviceability.



### 4. Easy access to drain hose and piping connection.

With larger piping space, pipes and insulations are securely and neatly hidden.

With the visible piping storage, pipes can easily be inspected for leaks without lifting the unit.

Piping storage: up to 15% larger (for TZ-ZKE).



Bigger working space.

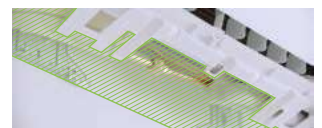

### 5. Easy wire insertion and tightening.

The models have combined 2 wire inserts into 1, ensuring front visibility and convenience while inserting wires from the back.

Single tunnel: easy wire insert.

Bigger working space for wiring connection.



### 6. Easy removal of PCB.

PCB removal is achieved in just 4 easy steps. Simply remove the control board cover, disconnect all connectors from the indicator, disconnect all connectors and pull out the main PCB.

Simple steps for PCB removal.

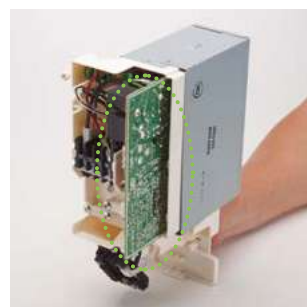

### 7. Easy / hidden installation of the Wi-Fi adapter.

The latest model features a dedicated space for a network adapter. Easy to plug in, the guided wire slots allow for clear, easy installation and can be neatly tucked away - simple and out of sight!

\* Only for models without built-in network adapter.



### 8. Cross flow fan removal.

The models are carefully designed to make removal of cross flow fans easier compared to the previous models, saving valuable time.

Bigger diameter: up to Ø105 (for Z-ZKE).



## Floor console. Efficient comfort and clean air all year round

Floor console with nanoe™ X technology: outstanding efficiency A++, comfort (Super Quiet technology only 20 dB(A)) and better air quality combined in a breakthrough design.





The iF Product Design Awards are among the most prestigious awards for product design excellence. Winning the award thanks to its highly intelligent functionality, the Panasonic Floor console is the ideal air-conditioning system for domestic and commercial applications.

[+ SEE PRODUCT SPECIFICATIONS](#)

## 1 nanoe™ X: Bringing nature's balance indoors

Panasonic's nanoe™ X technology brings nature's detergent – hydroxyl radicals – indoors to help improve protection 24/7 against several types of pollutants can be inhibited such as certain types of bacteria, viruses, mould, allergens, pollen or hazardous substances.

The nanoe™ X performance varies depending on the room size, environment and usage and it may take several hours to reach the full effect (see page 155 for more detail). nanoe™ X is not medical device, local regulations on building design and sanitary recommendations must be followed.

## 2 Super Quiet operation

When the system reaches its set temperature, the unit will operate at only 20 dB(A). Creating a comfortable home is not only by temperature - a quiet atmosphere is also important.

## 3 Designed to follow the high European demands

Super Quiet operation, highly efficient and technology to help clean the air.

### Double air flow for improved comfort and temperature dispersion: through the top for an efficient operation



### Stylish infrared control

Enjoy innovative design at your fingertips with the stylish and sleek Backlit Sky Controller. Bigger screen and easier to use.



### Easy to integrate into your home

A breakthrough design that integrates perfectly with any style. We have carefully selected materials and processes to create an elegant design. Compact in size and with a stylish design, the floor console will easily integrate into your home's interior decoration. There are four options available:



### High energy efficiency class A++

The floor console brings the outdoor heat energy inside. Can provide heat inside even when it is -15 °C outside.

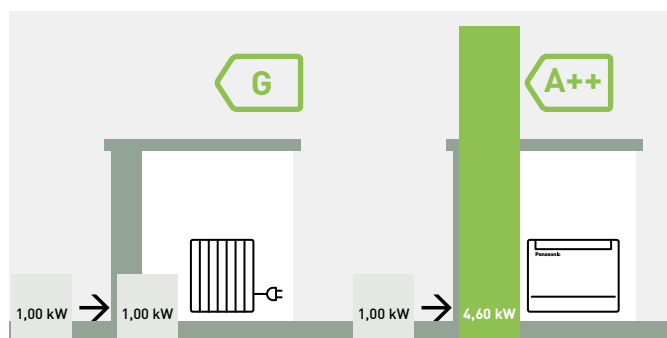

\* SCOP on heating mode for Floor console Type KIT-Z25-UFE and KIT-Z35-UFE compared with electrical heaters at +7 °C.

### The perfect solution for the replacement of old boiler heating systems



## Power Heat Multi system

Powerful heating and cleaner indoor air from a single outdoor unit.

The multi split system engineered for cold climates.



Check out the installation of the Power Heat Multi system at the Arctic Treehouse Hotel in Lapland, Finland.



Powerful heating of two or three rooms with one outdoor unit, even at  $-25\text{ }^{\circ}\text{C}$  low outdoor temperatures.

The multi split solution offers high flexibility, as 2 to 3 indoor units can be connected to a single outdoor unit.

## POWER HEAT

+ SEE PRODUCT SPECIFICATIONS

Reliable heating for the coldest winters.

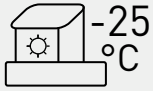

Reliable heating even at  $-25\text{ }^{\circ}\text{C}$ .



Equipped with base pan heater.

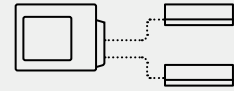

Compatible with Etherea indoor units, with nanoe™ X.

Reduces the burden of aesthetics, installation and maintenance.

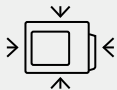

Seamless integration of outdoor unit.

Reduced outdoor unit space, harmonizing with building architecture.



Reduced installation time.

Faster piping connection and pump-down time.



Excellent maintainability.

Advantageous under harsh conditions.

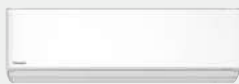

Etherea



### **$-25\text{ }^{\circ}\text{C}$ outdoor temperature operation and base pan heater.**

The heater prevents the outdoor unit base pan from freezing and ensures stable operation even in extremely cold regions.

### **Heating capacity at $-25\text{ }^{\circ}\text{C}$ outdoor temperature: 3,90 kW for the 2-room model and 4,30 kW for the 3-room model.**

Efficiently heats 2 or 3 rooms using a single outdoor unit, even in low outdoor temperatures.

### **High efficiency SCOP 4,60 A++.**

High heating efficiency contributes to environmental protection while reducing electricity bills.

### **Dark color outdoor unit.**

First outdoor unit in dark color, blending seamlessly with home exteriors without compromising aesthetics.

### **Connectable to Etherea indoor units.**

Comfort and convenience with nanoe™ X and built-in Wi-Fi, combined with excellent heating and cooling performance.

### **Shorter installation time (faster than two single units).**

Requires shorter installation times compared to installing multiple single units, reducing the installer's workload.

## Panasonic R2 rotary compressor

The secret is flexibility. Panasonic Inverter air conditioners have the flexibility to vary the rotation speed of the compressor. This allows it to use less energy to maintain the set temperature while also being able to cool the room quicker at start up.

So you can enjoy better savings on your electricity bills while maintaining cooling comfort.



R2 rotary compressors utilize rolling piston technology. The R2 compressor has been tested in extreme conditions: higher efficiency, single and dual piston, R32 / R410A refrigerant, compact size.



**Making the world a cooler place since 1978.**

Panasonic rotary compressors for room air conditioners have been installed in the most demanding environments around the world. Designed to withstand extreme conditions, Panasonic Rotary delivers high performance, efficiency and reliable service, no matter where you are. Panasonic, the world's largest manufacturer of rotary compressors.

**Why is the Panasonic R2 rotary compressor so efficient?**

1. High efficiency motor. The premium silicon steel motor meets industry efficiency requirements.
2. Improved lubrication of high volume oil pump. The extended, high volume oil pump in conjunction with a larger capacity oil reservoir provides superior lubrication.
3. Accumulator has larger refrigerant capacity. The larger accumulator accommodates generous refrigerant amounts needed in longer line length installations.



\* This image is for 5,0 / 7,1 kW.

**R2 compressor value**

**About R2 compressor.**

Built upon 36 years of compressor design and production experience, R2 is the next generation of rotary compressors for residential central air conditioning. The technology improvements, enhanced materials and simple design ensure R2 compressors are reliable, efficient and quiet. The R2 compressor delivers quality, comfort and peace of mind in homes around the world. Panasonic's Rotary Compressors have been life tested in some of the world's most demanding environments and the R2 design is the compressor of choice by contractors and homeowners in these challenging climates. For the high performance that home-owners demand, R2 rotary compressors are considered by the industry experts.

**Leading technology.**

Used in over 80% of cooling solutions globally, rotary is the world's dominant residential air conditioning compression technology. Panasonic is the leading rotary and residential AC compressor manufacturer in the world, with over 200 million compressors produced.

**Benefits.**

Central air conditioning delivered with a Panasonic R2 rotary compressor ensures a superior level of comfort at an economical cost.

**Inverter technology**

**Great energy-saving performance. Reduces electricity consumption.**

Panasonic Inverter air conditioners are designed to give you exceptional energy savings and performance. At the start up of an air conditioner's operation, a boost in power is required to reach the set temperature. After the set temperature is reached, less power is required to maintain it. The Panasonic Inverter air conditioner varies the rotation speed of the compressor. This provides a highly precise method of maintaining the set temperature.

**Constant comfort.**

Precise temperature control with a wide power output range enables an Inverter air conditioner to meet different room occupancy levels – thus ensuring constant comfort.

**Quick comfort.**

Panasonic Inverter air conditioners can operate with higher power during the start up period to cool the room 1,5 times faster and heat the room 4 times faster than non-Inverter models.

**Comparison of cooling speed.**

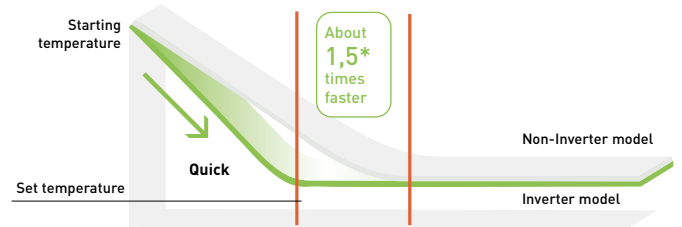

\* Comparison of 3,5 kW Inverter vs. non-Inverter. Outside room temperature: 35 °C; setting temperature: 25 °C.

**Comparison of heating speed.**

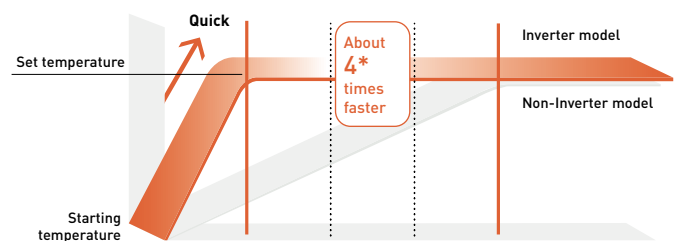

\* Comparison of 2,5 kW Inverter vs. non-Inverter. Outside room temperature: 2 °C ; setting temperature: 25 °C.

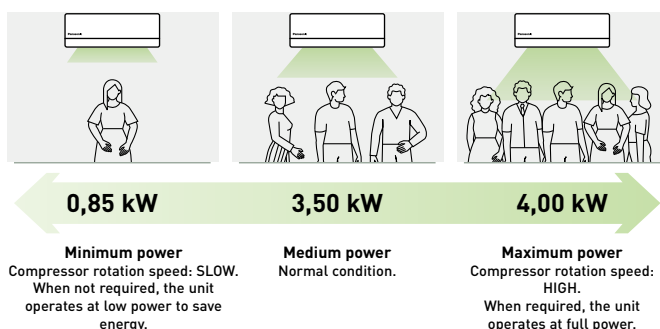

\* Graph shows the 3,5 kW Inverter model's wide power output range during cooling.

## R22 Renewal. Panasonic standard units can be installed on existing R22 pipings

Change your old air conditioning system to a more efficient system!



## An important drive to further reduce the potential damage to our ozone

- All Panasonic standard SKE, TKE and UKE units can be installed on existing R22 pipings
- No need for additional accessories (only pipe reductions)
- Approximately 30% energy savings compared to R22 units

### Panasonic is doing its part

We at Panasonic are also doing our part – recognising that all finances are under pressure at the moment. Panasonic has developed a clean and cost effective solution to enable this latest legislation to be introduced with as minimum an effect on businesses and cash reserves as possible.

The Panasonic renewal system allows good quality existing R22 pipe work to be re-used whilst installing new high efficiency R410A / R32 systems.

By bringing a simple solution to the problem Panasonic can renew all Split Systems and PACi systems; and depending upon certain restrictions we don't even limit the manufacturer's equipment we are replacing.

By installing a new high efficiency Panasonic R410A / R32 system you can benefit from around 30% running cost saving compared to the R22 system.

Yes...

1. Check the capacity of the system you wish to replace
2. Select from the Panasonic range the best system to replace it with
3. Follow the procedure detailed in the brochure and technical data

Simple...

R22 - The reduction of Chlorine critical for a cleaner future.



### Guidance on re-using existing R22 piping for a new R410A / R32 installation

#### 1. Precaution.

The existing R22 piping can be re-used for a R410A / R32 system installation if the following conditions are met and the piping are finally verified to be:

- Dry (no moisture remaining in the piping)
- Clean (no dust remaining in the piping)
- Tight (no refrigerant leak at the joining and piping)

#### 2. Conditions.

- Recover the refrigerant and oil.  
Operate "force cooling" according to the recommended operation time, regardless of the piping length. Single split: 10 min. Multi split: 30 min. After that, carry out "pump down" to recover the refrigerant and oil from the existing R22 system

\* Note: If pump down operation is not possible due to the malfunction of the system, flush and wash the existing piping to collect back the oil and dirt inside the system.

- Check the oil condition. If the oil contains dirt, wash the existing pipes
- Check the oil colour. After pump down, use a cotton bud to wipe the oil from the existing pipe. If the oil colour is higher than ASTM3, use a new pipe as re-use of old piping is not allowed
- Check pipe thickness. Make sure that the pipe thickness is more than 0,8 mm. If the thickness is less than 0,8 mm, use a new pipe
- Rework the flare for R410A / R32 connection. Do not reuse the old flare nuts

#### Deterioration criteria for refrigerant oil.

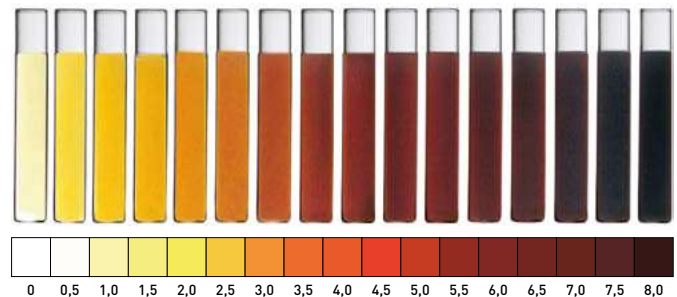

Make sure to use the new flare nuts attached to the R410A / R32 system.

\* Note: If the existing piping size is 1/4" (6,35 mm) and 1/2" (12,7 mm), and the new R410A / R32 system is 1/4" (6,35 mm) and 3/8" (9,52 mm), use a pipe reducer connected at indoor and outdoor unit.

#### 3. Applicable model.

Panasonic single split room air conditioner from CS/ CU-RE/UE/YE/XE/CE/NE/E\*NKE and PKE series onwards.  
Panasonic multi split room air conditioner from CU-2E/3E/4E/5PBE series onwards.

		Liquid		1/4 (6,35)	
		Gas	3/8 (9,52)	1/2 (12,70)	5/8 (15,88)
Split	16 / 20 / 25 / 35	1,6 - 3,5 kW	✓	▲	✗
	42 / 50 / 60	4,2 - 6,0 kW	✗	✓	▲
	71	6,8 - 7,5 kW	✗	✗	✓

✓ Standard piping connection with current piping length and refrigerant charge rules.

▲ This combinations is allowed respecting maximum piping length and refrigerant charged declared in model installed as new.

✗ This combinations is not allowed as it is out of piping diameter.

# Welcome to the connected world of Panasonic Comfort Cloud App

Whether you are at home or at work, the Panasonic Comfort Cloud App puts total control of your indoor air quality at your fingertips.



Comfort Cloud



**nanoe™ X: improving protection 24/7.**



**Monitor energy consumption.**



**Remote control.**



**Pre-heat or cool spaces.**



**Weekly timer.**



**Error notifications.**



**Voice Control.**

## nanoe™ X: improving protection 24/7

Panasonic Comfort Cloud App allows you to see the nanoe™ X coverage in your space through a simulation.



Turn nanoe™ X on easily with “One-touch nanoe™ button” on the main screen.



Select the room shape and size and the unit installation position.

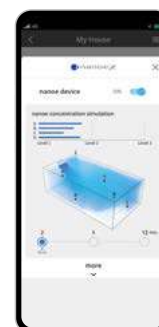

Observe the simulation of nanoe™ X concentration over time!

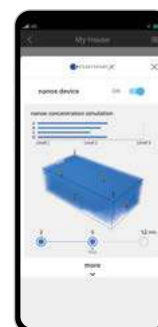

See page 154 for more detail.

**Monitor energy consumption.**

Check the energy consumption of each unit at different time intervals to maximise energy savings and further reduce operation costs. The electricity tariff can be set by the user and the app will provide the estimated electricity bill for the heat pump.

\* Electricity bill and energy consumption are estimated values. Actual usage may vary. For the multi split air conditioner, electricity bill and energy consumption will be the same for all indoor units.

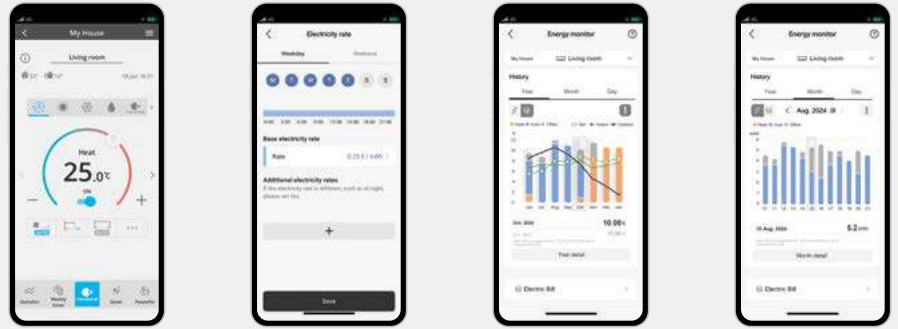

The Panasonic Comfort Cloud Application enables you to conveniently manage and monitor multiple air conditioning units for homes from just one mobile device. Also, energy monitoring is possible allowing opportunity to learn how to reduce the operating cost even more.

- Connectable up to 200 units\* with just 1 device
- Compatible for both residential and commercial applications

\* 10 different groups, with up to 20 units / per group.



**Easier setup with advanced built-in Wi-Fi**

The advanced built-in Wi-Fi setup enables secured and easier connection to Panasonic Comfort Cloud App by scanning the QR code\*.

\*Feature available only in CS-XZ\*\*ZKEW-H, CS-XZ\*\*ZKEW, CS-MZ16ZKE, CS-Z\*\*ZKEW, CS-MTZ16ZKE and CS-TZ\*\*ZKEW.

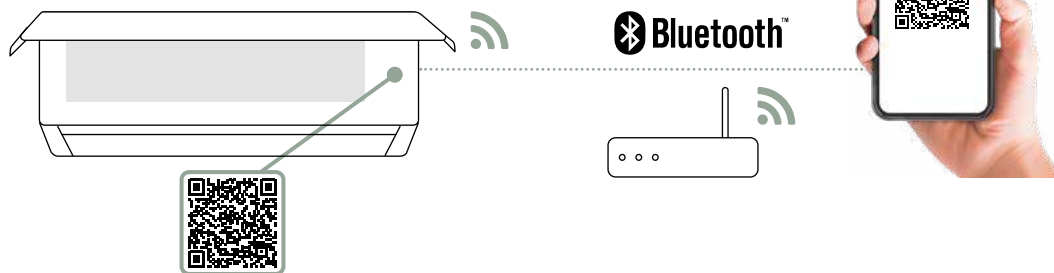

Scan the QR code to enable easier Wi-Fi connectivity to the air conditioner.

**Requirements for connecting with Panasonic Comfort Cloud App**



**Indoor unit with built-in Wi-Fi:**  
CS-XZ\*\*ZKEW-H, CS-XZ\*\*ZKEW, CS-MZ16ZKE, CS-Z\*\*ZKEW, CS-MTZ16ZKE, CS-TZ\*\*ZKEW and CS-Z\*\*YKEA-1.

Remark: indoor temperature display and some special functions are not available through the app for all models. Languages: Available in 20 European languages: Bulgarian, Croatian, Czech, Danish, Deutsch, English, Estonian, Finnish, French, Greek, Hungarian, Italian, Norwegian, Polish, Portuguese, Slovenian, Spanish, Swedish, Turkish and Lithuanian.



**Indoor unit with optional CZ-TACG1 Wi-Fi adapter:**  
CS-VZ\*\*SKE, CS-BZ\*\*ZKE, CZ-UZ\*\*ZKE, CS-MZ20UFEA, CS-Z\*\*UFEAW, CS-MZ20UD3EA and CS-Z\*\*UD3EAW

**Indoor unit with optional CZ-CAPWFC2 Wi-Fi adapter or CONEX remote controller:**  
S-M20PY3E and S-\*\*PY3E.

**Download free app: Panasonic Comfort Cloud App.**

Other hardware requirements: Router and Internet (purchase and subscribe separately). Built-in Wi-Fi in certain models or with optional adaptor CZ-TACG1 connected to port CN-CNT. Panasonic Cloud Server is designed, operated and managed by Panasonic.

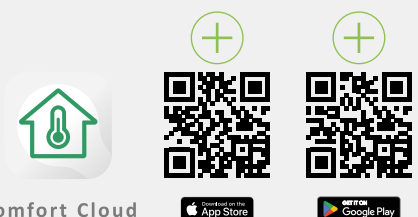

# Voice Control. Words do more than actions

Boundless control and hands-free help to access all the features of your air-to-air heat pump. Maximising your comfort is now a breeze with our connected air conditioners using the Panasonic Comfort Cloud App and voice control.



## Seamless set up in 3 simple steps

Set up your Panasonic Comfort Cloud App.



Set up your Google Nest Mini or Amazon Echo devices and app.



Link your Google Nest Mini or Amazon Echo with Panasonic Comfort Cloud App.



### Compatible devices as of July 2024:

1. Android™ 8.1 or above
2. iOS 14.7 or above

**Please note:**

- This is not a definitive list of all compatible devices, other similar devices which use supported Operating Systems should also work either via dedicated apps. Please note that user experience may vary slightly depending on hardware and software combination
- Google, Android™, Google Play and Google Home are trademarks of Google LLC.
- Google Assistant is not available in certain languages and countries
- Amazon, Alexa and all related logos are trademarks of Amazon.com, Inc. or its affiliates
- Availability of Voice Assistant services varies depending on country and language
- Google Assistant and Alexa are compatible with the models shown in pages 178 and 179.



### Turn ON / OFF air conditioner

#### Convenient control for blissful rest.

Turn ON / OFF AC with ease when preparing a comfortable space for your little ones.

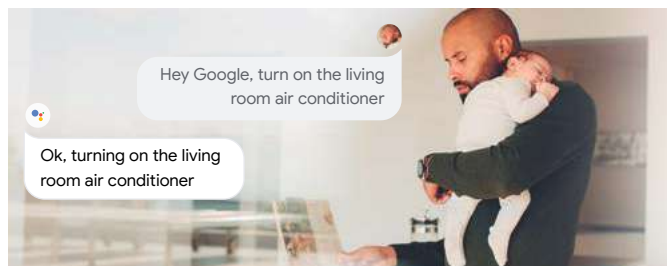

### Adjust temperature

#### Easy control for uninterrupted quality time.

Adjust AC temperature to your comfort with a simple voice command.

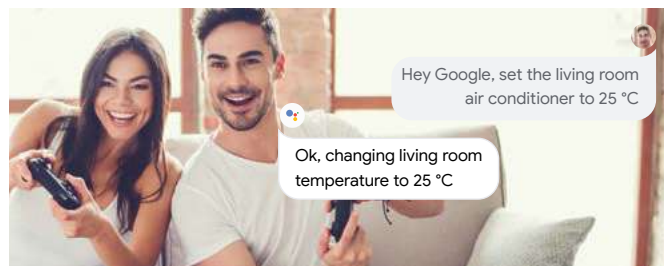

### Change mode

#### Extra help when you have a hectic day.

Conveniently change your AC operation mode to cool / heat / auto when your hands are full.



### Check current status

#### Hands-free comfort for the whole family.

Easy access for the elderly to check current AC operation status and adjust AC settings.



### Get multiple things done with your voice

Simplify your day with your personalised routine by grouping individual actions.

#### Schedule your routine with your voice.

With the routine function, you can customise voice commands and control multiple voice-controlled devices including our network-enabled air conditioners to help you with your personalised routine.

Find out more (Amazon): <https://www.techhive.com/article/3327501/how-to-use-alexa-routines.html>

#### Example of morning routine.

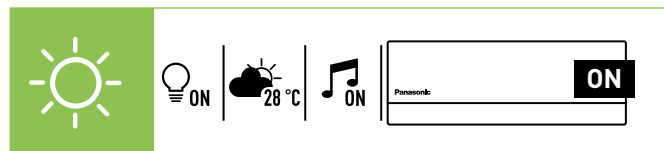

#### Example of night routine.

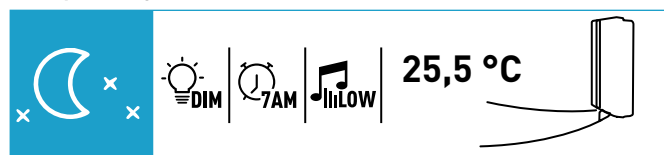

### Voice Control with Network-Enabled air conditioners

Functions	When you are home		When away from home
	Remote control	Voice Control	Panasonic Comfort Cloud App
Smart control	Power ON / OFF	✓	✓
	Control multiple units in 1 location	—	✓
	Control multiple units in multiple locations	—	✓
	Set up and manage routines	—	—
Smart comfort	Cooling mode	✓	✓
	Heating mode	✓	✓
	Auto mode	✓	✓
	nanoe™ X mode	✓	✓
	Inside cleaning	✓	✓
	Summer House mode	✓	✓
	Pre-cool	—	✓
Smart efficiency	Change temperature	✓	✓
	Analyse energy usage patterns	—	✓
	Compare historical usage	—	✓
Smart assist	Receive error notifications	—	✓
	Assign multiple users	—	✓
	Check power ON / OFF	✓	✓
	Check temperature settings	✓	✓
	Check room temperature	✓	✓

## Control and connectivity

Panasonic offers its customers cutting-edge technology, specially designed to ensure our air conditioning systems deliver even higher performance.

You can properly manage the air conditioning and perform comprehensive monitoring and control, with all of the features the remote controller provides at home, from anywhere in the world thanks to the internet applications Panasonic has created for you.



### Wi-Fi adapter for smart control via Panasonic Comfort Cloud App

#### **CZ-TACG1. Wi-Fi adaptor (optional)\*.**

- Optional Wi-Fi adaptor for domestic range
- Compact size for easy installation
- Available for built-in or exposed installation depending on model type

\* Functionality varies depending on models. Please contact your local dealers for compatible models.

#### **Specifications.**

- Input voltage: DC 12 V
- Power consumption: Maximum 660 mW
- Size (H x W x D): 66 x 36 x 12 mm
- Mass: Approx. 85 g
- Interface: 1 x Wireless LAN
- Wireless LAN standard: IEEE 802,11 b/g/n
- Frequency range: 2,4GHz band
- Encryption: WPA2-PSK (TKIP/AES)





## Domestic integration to S-Link

### CZ-CAPRA1

Can connect RAC range to S-Link. Full control is now possible.

#### Integrates any unit in big system control.

- YKEA server room integration <sup>1)</sup>
- Small offices with domestic indoors
- Tender for refurbishment (old system Domestic and VRF in one installation)
- Centralized Control Systems: 64 indoor units
- Intelligent controller / Web Server: 256 indoor units
- Panasonic AC Smart Cloud

- Basic operation items: ON / OFF, Mode select, Temperature setting, Fan speed, Flap setting, Remote control prohibit
- External input: ON / OFF control signal, Abnormal stop signal
- External output for Relay <sup>2)</sup>: Operation status (ON / OFF), Alarm status output

1) When duty rotation using the remote controller is set up, CZ-CAPRA1 cannot be connected.  
2) Because current CN-CNT connector can not provide the power for external output relay, additional 12 V DC power supply for external relay is necessary.

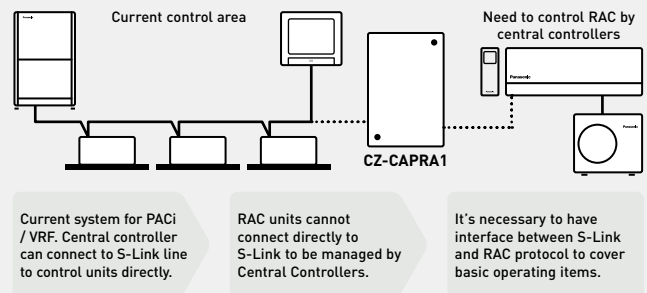

## Control by BMS

### PAW-AC-KNX-1i (Intesis), PAW-AC-MBS-1 (Intesis), PAW-AC-BAC-1 <sup>1)</sup> (Intesis), PAW-AZAC-KNX-1 (Airzone), PAW-AZAC-MBS-1 (Airzone) and PAW-AZAC-BAC-1 (Airzone).

Great flexibility for integration into your KNX, Modbus and BACnet projects allows fully bi-directional monitoring and control of all the functioning parameters.

- Quick Installation
- External power not required
- Direct connection to the unit via CN-CNT connector
- Bidirectional control
- Unit can be controller simultaneously by remote controller and the gateway

1) This interface allows a complete and natural integration of Panasonic air conditioners into either BACnet IP or MS/TP networks. Is a BTL certified device. \* For specific functionality list of each gateway, please check the user's manual.

## Easy connectivity











CN-CNT port easy to access in all indoor units, without dismantling the unit to reach the connector. Can easier connect: Wireless accessory / KNX / Modbus / BACnet / CZ-TACG1 / CZ-CAPRA1 to integrate to PACi control.



Model name	Interface
CZ-TACG1	Wi-Fi adapter for smart control via Panasonic Comfort Cloud App
CZ-CAPRA1	RAC interface adapter for integration into S-Link, plus external input and alarm/status output
PAW-AC-KNX-1i	KNX interface. Can be used with all models which have a CN-CNT connector (Intesis)
PAW-AC-MBS-1	Modbus interface. Can be used with all models which have a CN-CNT connector (Intesis)
PAW-AC-BAC-1	BACnet interface. Can be used with all models which have a CN-CNT connector (Intesis)

Model name	Interface
PAW-AZAC-KNX-1	KNX interface. Can be used with all models which have a CN-CNT connector (Airzone)
PAW-AZAC-MBS-1	Modbus interface. Can be used with all models which have a CN-CNT connector (Airzone)
PAW-AZAC-BAC-1	BACnet interface. Can be used with all models which have a CN-CNT connector (Airzone)
PAW-AC-DIO	This interface can be used with all models which have a CN-RMT connector

## Domestic air conditioner R32 range





















Page	Single split units	2,0 kW	2,5 kW	3,5 kW	4,2 kW	5,0 kW	6,0 kW	7,1 kW
<b>Wall-mounted Heatcharge VZ · R32</b>								
P. 180			CS-VZ9SKE CU-VZ9SKE	CS-VZ12SKE CU-VZ12SKE				
<b>Wall-mounted Etherea · R32</b>								
		CS-XZ20ZKEW-H CU-Z20ZKE	CS-XZ25ZKEW-H CU-Z25ZKE	CS-XZ35ZKEW-H CU-Z35ZKE	CS-XZ42ZKEW-H CU-Z42ZKE			
P. 181		CS-XZ20ZKEW CU-Z20ZKE	CS-XZ25ZKEW CU-Z25ZKE	CS-XZ35ZKEW CU-Z35ZKE		CS-XZ50ZKEW CU-Z50ZKE		
		CS-Z20ZKEW CU-Z20ZKE	CS-Z25ZKEW CU-Z25ZKE	CS-Z35ZKEW CU-Z35ZKE	CS-Z42ZKEW CU-Z42ZKE	CS-Z50ZKEW CU-Z50ZKE		CS-Z71ZKEW CU-Z71ZKE
<b>Wall-mounted TZ super-compact · R32</b>								
P. 182		CS-TZ20ZKEW CU-TZ20ZKE	CS-TZ25ZKEW CU-TZ25ZKE	CS-TZ35ZKEW CU-TZ35ZKE	CS-TZ42ZKEW CU-TZ42ZKE	CS-TZ50ZKEW CU-TZ50ZKE	CS-TZ60ZKEW CU-TZ60ZKE	CS-TZ71ZKEW CU-TZ71ZKE
<b>Wall-mounted BZ super-compact · R32</b>								
P. 183			CS-BZ25ZKE CU-BZ25ZKE	CS-BZ35ZKE CU-BZ35ZKE		CS-BZ50ZKE CU-BZ50ZKE	CS-BZ60ZKE CU-BZ60ZKE	
<b>Wall-mounted UZ super-compact · R32</b>								
P. 184			CS-UZ25ZKE CU-UZ25ZKE	CS-UZ35ZKE CU-UZ35ZKE		CS-UZ50ZKE CU-UZ50ZKE		
<b>Floor console · R32</b>								
P. 185			CS-Z25UFEAW CU-Z25UBEAW	CS-Z35UFEAW CU-Z35UBEAW		CS-Z50UFEAW CU-Z50UBEAW		
<b>Low static pressure hide-away · R32</b>								
P. 186			CS-Z25UD3EAW CU-Z25UBEAW	CS-Z35UD3EAW CU-Z35UBEAW		CS-Z50UD3EAW CU-Z50UBEAW	CS-Z60UD3EAW CU-Z60UBEAW	
<b>Stand-alone units</b>								
		<b>1,7 kW</b>		<b>2,0 kW</b>		<b>2,5 kW</b>		<b>3,0 kW</b>
<b>RAC Solo · R290 / R32</b>								
P. 195			P-M0G16IC5-E	P-MOZ20IC5-E		P-MOZ25IC5-E		P-MOZ30IC5-E

Try Panasonic's augmented reality tool, the AR Heat Pump Viewer.



Configure your multi split system in a few steps using our online tool and see all possible combinations.



Page	Multi split indoors	1,6 kW	2,0 kW	2,5 kW	3,5 kW	4,2 kW	5,0 kW	6,0 kW	7,1 kW
<b>Wall-mounted Etherea</b>									
			CS-XZ20ZKEW-H	CS-XZ25ZKEW-H	CS-XZ35ZKEW-H	CS-XZ42ZKEW-H			
P. 191			CS-XZ20ZKEW	CS-XZ25ZKEW	CS-XZ35ZKEW		CS-XZ50ZKEW		
		CS-MZ16ZKE	CS-Z20ZKEW	CS-Z25ZKEW	CS-Z35ZKEW	CS-Z42ZKEW	CS-Z50ZKEW		CS-Z71ZKEW
<b>Wall-mounted TZ super-compact</b>									
P. 191		CS-MTZ16ZKE	CS-TZ20ZKEW	CS-TZ25ZKEW	CS-TZ35ZKEW	CS-TZ42ZKEW	CS-TZ50ZKEW	CS-TZ60ZKEW	CS-TZ71ZKEW
<b>Floor console</b>									
P. 191			CS-MZ20UFEA	CS-Z25UFEAW	CS-Z35UFEAW		CS-Z50UFEAW		
<b>4 way 60x60 cassette</b>									
P. 191			S-M20PY3E CZ-KPY4	S-25PY3E CZ-KPY4	S-36PY3E CZ-KPY4		S-50PY3E CZ-KPY4	S-60PY3E CZ-KPY4	
<b>Low static pressure hide-away</b>									
P. 191			CS-MZ20UD3EA	CS-Z25UD3EAW	CS-Z35UD3EAW		CS-Z50UD3EAW	CS-Z60UD3EAW	
<b>Free Multi system</b>									
Page	Free Multi system	3,2 ~ 6,0 kW	3,2 ~ 6,0 kW	3,2 ~ 7,7 kW	4,5 ~ 9,5 kW	4,5 ~ 11,2 kW	4,5 ~ 11,5 kW	4,5 ~ 14,7 kW	4,5 ~ 18,3 kW
P. 190	Outdoor units Free Multi system · R32								
		CU-2Z35TBE	CU-2Z41TBE	CU-2Z50TBE	CU-3Z52TBE	CU-3Z68TBE	CU-4Z68TBE	CU-4Z80TBE	CU-5Z90TBE
<b>Power Heat Multi system</b>									
Page	Power Heat Multi system	4,0 ~ 8,5 kW (2 room)				4,5 ~ 11,0 kW (3 room)			
P. 192	Outdoor units Power Heat Multi system · R32								
		CU-2Z50ABEC				CU-3Z75ABEC			
<b>Multi wall TZ system</b>									
Page	Multi wall TZ system	3,2 ~ 6,0 kW			3,2 ~ 7,7 kW		4,5 ~ 9,5 kW		
P. 193	Outdoor units Multi wall TZ system for TZ indoors · R32								
		CU-2TZ41TBE			CU-2TZ50TBE		CU-3TZ52TBE		

## Wall-mounted Heatcharge VZ · R32

- Energy Charge System. Heat storage unit which utilizes non-stop heating and fast heating function
- Econavi Sunlight Detection sensor: Even higher efficiency and great comfort
- nanoe™ technology to improve protection 24/7
- Super Quiet! Only 18 dB(A), equivalent to night-time in the countryside
- Performance tested at -35 °C outdoor temperature



Optional 



Kit			KIT-VZ9-SKE	KIT-VZ12-SKE
Cooling capacity	Nominal (Min - Max)	kW	2,50 [0,60 - 3,00]	3,50 [0,60 - 4,00]
<b>SEER<sup>1)</sup></b>			<b>10,50 A+++</b>	<b>10,00 A+++</b>
Pdesign (cooling)		kW	2,50	3,50
Input power	Nominal (Min - Max)	kW	0,43 [0,14 - 0,61]	0,80 [0,14 - 0,98]
Annual energy consumption <sup>3)</sup>		kWh/a	83	122
Heating capacity	Nominal (Min - Max)	kW	3,60 [0,60 - 7,80]	4,20 [0,60 - 9,20]
COP <sup>2)</sup>		W/W	5,63	5,04
Heating capacity at -7 °C		kW	5,00	5,60
COP at -7 °C <sup>2)</sup>		W/W	2,07	2,00
<b>SCOP<sup>1)</sup></b>			<b>6,20 A+++</b>	<b>5,90 A+++</b>
Pdesign at -10 °C		kW	3,60	4,20
Input power	Nominal (Min - Max)	kW	0,64 [0,14 - 2,72]	0,83 [0,14 - 3,16]
Annual energy consumption <sup>3)</sup>		kWh/a	812	995
<b>Indoor unit</b>			<b>CS-VZ9SKE</b>	<b>CS-VZ12SKE</b>
Power supply		V	230	230
Recommended fuse		A	16	16
Connection indoor / outdoor		mm <sup>2</sup>	4x1,5	4x1,5
Air flow	Cool / Heat (Hi)	m <sup>3</sup> /min	12,5 / 15,5	12,9 / 15,9
Sound pressure <sup>4)</sup>	Cool (Hi / Lo / Q-Lo)	dB(A)	44 / 27 / 18	45 / 33 / 18
	Heat (Hi / Lo / Q-Lo)	dB(A)	44 / 26 / 18	45 / 29 / 18
Dimension	H x W x D	mm	295 x 798 x 375	295 x 798 x 375
Net weight		kg	14,5	14,5
<b>Outdoor unit</b>			<b>CU-VZ9SKE</b>	<b>CU-VZ12SKE</b>
Air flow	Cool / Heat (Hi)	m <sup>3</sup> /min	33,1 / 33,1	35,4 / 33,9
Sound pressure <sup>4)</sup>	Cool / Heat (Hi)	dB(A)	49 / 49	50 / 50
Dimension <sup>5)</sup>	H x W x D	mm	630 x 799 x 299	630 x 799 x 299
Net weight		kg	39,5	39,5
Piping diameter	Liquid	Inch (mm)	1/4 [6,35]	1/4 [6,35]
	Gas	Inch (mm)	3/8 [9,52]	3/8 [9,52]
Pipe length range		m	3 - 15	3 - 15
Elevation difference (in / out)		m	12	12
Pre-charged pipe length		m	7,5	7,5
Additional gas amount		g/m	20	20
Refrigerant (R32) / CO <sub>2</sub> Eq.		kg / T	1,05 / 0,70875	1,10 / 0,7425
Operating range	Cool Min ~ Max	°C	-10 ~ +43	-10 ~ +43
	Heat Min ~ Max	°C	-30 ~ +24	-30 ~ +24
Lowest outdoor temperature tested by 3rd party laboratory <sup>6)</sup>		°C	-35	-35

1) Energy Label Scale from A+++ to D. 2) EER and COP calculation is based in accordance to EN 14511. 3) The annual energy consumption is calculated in accordance to EU/626/2011. 4) The sound pressure of the indoor unit shows the value measured of a position of 1 m in front of the main body and 0,8 m below the unit. For outdoor unit 1 m in front and 1 m in rear side of main body. The sound pressure is measured in accordance with JIS C 9612. Q-Lo: Quiet mode. Lo: The lowest set fan speed. 5) Add 70 mm for piping port. 6) Tested by 3rd party laboratory, SP, according to EN 14511:2013 and SP Method 1721, this temperature is not guaranteed by Factory.

### Accessories

**CZ-TACG1** Wi-Fi adapter for smart control via Panasonic Comfort Cloud App

### Accessories

**CZ-CAPRA1** RAC interface adapter for integration into S-Link



SEER and SCOP: For KIT-VZ9-SKE. -35 °C HEATING MODE: Heating performance tested at -35 °C by SP, European third party laboratory. INTERNET CONTROL: Optional.

Wall-mounted Etherea · R32

- nanoe™ X technology to improve protection 24/7
- Stylish, monolithic design available in graphite grey, silver and matt white
- Improved SEER / SCOP for top class energy efficiency
- Aerowings 2.0 for the ultimate comfort
- Easy-to-use remote controller
- Built-in Wi-Fi for smart control via Panasonic Comfort Cloud App
- Compatible with Google Assistant and Amazon Alexa
- Chassis and parts designed for easier installation



Kit graphite grey			KIT-XZ20-ZKE-H	KIT-XZ25-ZKE-H	KIT-XZ35-ZKE-H	KIT-XZ42-ZKE-H	—	—
Kit silver			KIT-XZ20-ZKE	KIT-XZ25-ZKE	KIT-XZ35-ZKE	—	KIT-XZ50-ZKE	—
Kit matt white			KIT-Z20-ZKE	KIT-Z25-ZKE	KIT-Z35-ZKE	KIT-Z42-ZKE	KIT-Z50-ZKE	KIT-Z71-ZKE
Cooling capacity	Nominal (Min - Max)	kW	2,05 (0,75 - 2,65)	2,50 (0,85 - 3,50)	3,50 (0,85 - 4,20)	4,20 (0,85 - 5,00)	5,00 (0,98 - 6,00)	7,10 (0,98 - 8,50)
EER <sup>1)</sup>	Nominal (Min - Max)	W/W	4,66 (4,69 - 4,02)	4,90 (5,00 - 3,89)	4,27 (4,25 - 3,62)	3,39 (3,62 - 3,18)	3,68 (3,92 - 3,16)	3,24 (2,33 - 2,83)
<b>SEER <sup>2)</sup></b>			<b>8,70 A+++</b>	<b>9,50 A+++</b>	<b>9,50 A+++</b>	<b>7,10 A++</b>	<b>8,50 A+++</b>	<b>6,50 A++</b>
Pdesign (cooling)		kW	2,1	2,5	3,5	4,2	5,0	7,1
Input power	Nominal (Min - Max)	kW	0,44 (0,16 - 0,66)	0,51 (0,17 - 0,90)	0,82 (0,20 - 1,16)	1,24 (0,24 - 1,57)	1,36 (0,25 - 1,90)	2,19 (0,42 - 3,00)
Annual energy consumption <sup>3)</sup>		kWh/a	84	92	129	207	206	382
Heating capacity	Nominal (Min - Max)	kW	2,80 (0,75 - 4,00)	3,40 (0,80 - 4,80)	4,00 (0,80 - 5,50)	5,30 (0,80 - 6,80)	5,80 (0,98 - 8,00)	8,20 (0,98 - 10,20)
Heating capacity at -7 °C		kW	2,38	2,8	3,2	4,11	4,8	6,31
COP <sup>1)</sup>	Nominal (Min - Max)	W/W	4,67 (4,69 - 4,26)	4,86 (5,00 - 4,07)	4,55 (4,44 - 3,77)	3,73 (4,21 - 3,66)	4,14 (4,26 - 3,35)	3,73 (2,45 - 3,31)
<b>SCOP <sup>2)</sup></b>			<b>4,80 A++</b>	<b>5,20 A+++</b>	<b>5,20 A+++</b>	<b>4,30 A+</b>	<b>4,80 A++</b>	<b>4,20 A+</b>
Pdesign at -10 °C		kW	2,4	2,6	2,9	3,6	4,2	5,5
Input power	Nominal (Min - Max)	kW	0,60 (0,16 - 0,94)	0,70 (0,16 - 1,18)	0,88 (0,18 - 1,46)	1,42 (0,19 - 1,86)	1,40 (0,23 - 2,39)	2,20 (0,40 - 3,08)
Annual energy consumption <sup>3)</sup>		kWh/a	700	700	781	1172	1225	1833
Indoor unit graphite grey			CS-XZ20ZKEW-H	CS-XZ25ZKEW-H	CS-XZ35ZKEW-H	CS-Z42ZKEW-H	—	—
Indoor unit silver			CS-XZ20ZKEW	CS-XZ25ZKEW	CS-XZ35ZKEW	—	CS-XZ50ZKEW	—
Indoor unit matt white			CS-Z20ZKEW	CS-Z25ZKEW	CS-Z35ZKEW	CS-Z42ZKEW	CS-Z50ZKEW	CS-Z71ZKEW
Power supply		V	230	230	230	230	230	230
Recommended fuse		A	16	16	16	16	16	20
Connection indoor / outdoor		mm <sup>2</sup>	4x1,5	4x1,5	4x1,5	4x1,5	4x2,5	4x2,5
Air flow	Cool / Heat	m <sup>3</sup> /min	10,4/11,9	12,4/13,0	12,7/14,4	14,5/15,4	17,4/19,1	19,0/19,9
Moisture removal volume		L/h	1,3	1,5	2	2,4	2,8	4,1
Sound pressure <sup>4)</sup>	Cool (Hi / Lo / Q-Lo)	dB(A)	35/24/19	39/25/19	42/28/19	43/31/25	44/37/30	47/38/30
	Heat (Hi / Lo / Q-Lo)	dB(A)	36/25/19	39/27/19	43/33/19	43/35/29	44/37/30	47/38/30
Dimension	H x W x D	mm	295 x 870 x 229	295 x 870 x 229	295 x 870 x 229	295 x 870 x 229	295 x 1040 x 244	295 x 1040 x 244
Net weight		kg	10	10	11	10	12	13
nanoe X Generator			Mark 3	Mark 3	Mark 3	Mark 3	Mark 3	Mark 3
Outdoor unit			CU-Z20ZKE	CU-Z25ZKE	CU-Z35ZKE	CU-Z42ZKE	CU-Z50ZKE	CU-Z71ZKE
Air flow	Cool / Heat	m <sup>3</sup> /min	26,5/25,7	28,7/26,5	29,8/29,8	29,8/30,9	39,8/36,9	44,7/45,8
Sound pressure <sup>4)</sup>	Cool / Heat (Hi)	dB(A)	45/46	46/47	48/50	49/51	47/47	52/54
Dimension <sup>5)</sup>	H x W x D	mm	542 x 780 x 289	542 x 780 x 289	542 x 780 x 289	542 x 780 x 289	695 x 875 x 320	695 x 875 x 320
Net weight		kg	27	27	31	31	40	45
Piping diameter	Liquid	Inch (mm)	1/4 (6,35)	1/4 (6,35)	1/4 (6,35)	1/4 (6,35)	1/4 (6,35)	1/4 (6,35)
	Gas	Inch (mm)	3/8 (9,52)	3/8 (9,52)	3/8 (9,52)	1/2 (12,70)	1/2 (12,70)	5/8 (15,88)
Pipe length range		m	3 - 15	3 - 15	3 - 15	3 - 15	3 - 30	3 - 30
Elevation difference (in / out)		m	15	15	15	15	15	20
Pre-charged pipe length		m	7,5	7,5	7,5	7,5	7,5	10
Additional gas amount		g/m	10	10	10	10	15	25
Refrigerant (R32) / CO <sub>2</sub> Eq.		kg / T	0,70/0,47	0,70/0,47	0,81/0,55	0,83/0,56	1,13/0,76	1,35/0,91
Operating range	Cool Min ~ Max	°C	-10 ~ +43	-10 ~ +43	-10 ~ +43	-10 ~ +43	-10 ~ +43	-10 ~ +43
	Heat Min ~ Max	°C	-20 ~ +24	-20 ~ +24	-20 ~ +24	-20 ~ +24	-20 ~ +24	-20 ~ +24

1) EER and COP calculation is based in accordance to EN 14511. 2) Energy Label Scale from A+++ to D. 3) The annual energy consumption is calculated in accordance to EU/626/2011. 4) The sound pressure of the indoor unit shows the value measured of a position of 1 m in front of the main body and 0,8 m below the unit. For outdoor unit 1 m in front and 1 m in rear side of main body. The sound pressure is measured in accordance with JIS C 9612. Q-Lo: Quiet mode. Lo: The lowest set fan speed. 5) Add 70 mm for piping port.

Accessories

**CZ-CAPRA1** RAC interface adapter for integration into S-Link

Accessories

**CZ-RD517C** Wired remote controller for wall-mounted and floor console



SEER and SCOP: For KIT-\*\*25-ZKE and KIT-\*\*35-ZKE. SUPER QUIET: For KIT-\*\*20-ZKE, KIT-\*\*25-ZKE and KIT-\*\*35-ZKE. INTERNET CONTROL: Built-in Wi-Fi.

## Wall-mounted TZ super-compact · R32

- nanoe™ X technology to improve protection 24/7
- Compact and elegant design with only 779 mm wide
- Built-in Wi-Fi for smart control via Panasonic Comfort Cloud App
- Compatible with Google Assistant and Amazon Alexa
- Easy-to-use remote controller
- Aerowings to control air draft direction

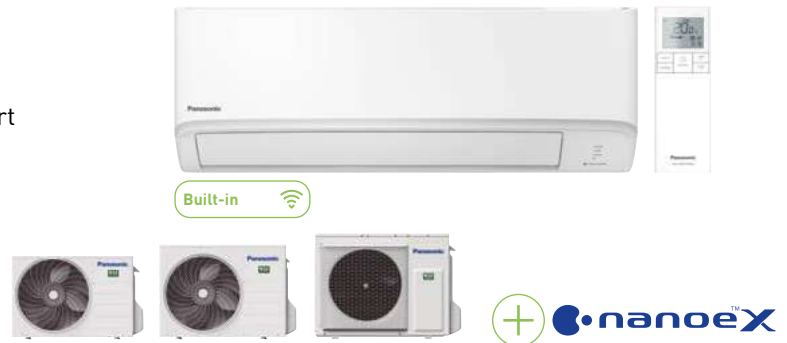

Kit			KIT-TZ20-ZKE	KIT-TZ25-ZKE	KIT-TZ35-ZKE	KIT-TZ42-ZKE	KIT-TZ50-ZKE	KIT-TZ60-ZKE	KIT-TZ71-ZKE
Cooling capacity	Nominal (Min - Max)	kW	2,00(0,75-2,50)	2,50(0,85-3,00)	3,50(0,85-4,00)	4,20(0,85-4,60)	5,00(0,98-5,60)	6,00(0,98-6,60)	7,10(0,98-8,40)
EER <sup>1)</sup>	Nominal (Min - Max)	W/W	4,08(4,17-3,91)	3,85(4,05-3,41)	3,57(3,62-3,33)	3,36(3,62-2,80)	3,13(3,92-2,96)	3,24(3,92-2,87)	3,23(2,33-2,80)
<b>SEER <sup>2)</sup></b>			<b>7,00 A++</b>	<b>7,10 A++</b>	<b>6,80 A++</b>	<b>6,40 A++</b>	<b>6,90 A++</b>	<b>6,80 A++</b>	<b>6,20 A++</b>
Pdesign (cooling)		kW	2,0	2,5	3,5	4,2	5,0	6,0	7,1
Input power	Nominal (Min - Max)	kW	0,49(0,18-0,64)	0,65(0,21-0,88)	0,98(0,24-1,20)	1,25(0,24-1,64)	1,60(0,25-1,89)	1,85(0,25-2,30)	2,20(0,42-3,00)
Annual energy consumption <sup>3)</sup>		kWh/a	100	123	180	230	254	309	401
Heating capacity	Nominal (Min - Max)	kW	2,70(0,70-3,60)	3,30(0,80-4,10)	4,00(0,80-5,10)	5,00(0,80-6,80)	5,80(0,98-7,50)	7,00(0,98-8,20)	8,20(0,98-10,20)
Heating capacity at -7 °C		kW	2,14	2,70	3,30	3,90	4,62	4,90	6,31
COP <sup>1)</sup>	Nominal (Min - Max)	W/W	4,15(4,24-3,53)	4,18(4,21-3,66)	4,04(4,10-3,70)	3,73(4,10-3,33)	3,41(4,67-3,26)	3,72(4,67-3,57)	3,71(2,45-3,29)
<b>SCOP <sup>2)</sup></b>			<b>4,60 A++</b>	<b>4,60 A++</b>	<b>4,60 A++</b>	<b>4,10 A+</b>	<b>4,50 A+</b>	<b>4,30 A+</b>	<b>4,10 A+</b>
Pdesign at -10 °C		kW	2,1	2,4	2,8	3,6	4,0	4,4	5,5
Input power	Nominal (Min - Max)	kW	0,65(0,17-1,02)	0,79(0,19-1,12)	0,99(0,20-1,38)	1,34(0,20-2,04)	1,70(0,21-2,30)	1,88(0,21-2,30)	2,21(0,40-3,10)
Annual energy consumption <sup>3)</sup>		kWh/a	639	730	852	1229	1244	1433	1878
<b>Indoor unit</b>			<b>CS-TZ20ZKEW</b>	<b>CS-TZ25ZKEW</b>	<b>CS-TZ35ZKEW</b>	<b>CS-TZ42ZKEW</b>	<b>CS-TZ50ZKEW</b>	<b>CS-TZ60ZKEW</b>	<b>CS-TZ71ZKEW</b>
Power supply		V	230	230	230	230	230	230	230
Recommended fuse		A	16	16	16	16	16	20	20
Connection indoor / outdoor		mm <sup>2</sup>	4x1,5	4x1,5	4x1,5	4x1,5	4x2,5	4x2,5	4x2,5
Air flow	Cool / Heat	m <sup>3</sup> /min	9,9/10,4	11,0/11,5	11,8/12,3	12,5/13,2	12,5/13,2	18,4/19,4	19,0/19,9
Moisture removal volume		L/h	1,3	1,5	2	2,4	2,8	3,3	4,1
Sound pressure <sup>4)</sup>	Cool (Hi / Lo / Q-Lo)	dB(A)	37/25/20	40/26/20	42/30/20	44/31/25	44/37/33	45/37/34	47/38/35
	Heat (Hi / Lo / Q-Lo)	dB(A)	38/26/22	40/27/22	42/33/22	44/35/28	44/37/33	45/37/34	47/38/35
Dimension	HxWxD	mm	290x779x209	290x779x209	290x779x209	290x779x209	290x779x209	295x1040x244	295x1040x244
Net weight		kg	8	8	8	8	8	12	13
nanoe X Generator			Mark 1	Mark 1	Mark 1	Mark 1	Mark 1	Mark 1	Mark 1
<b>Outdoor unit</b>			<b>CU-TZ20ZKE</b>	<b>CU-TZ25ZKE</b>	<b>CU-TZ35ZKE</b>	<b>CU-TZ42ZKE</b>	<b>CU-TZ50ZKE</b>	<b>CU-TZ60ZKE</b>	<b>CU-TZ71ZKE</b>
Air flow	Cool / Heat	m <sup>3</sup> /min	29,7/29,7	30,0/28,9	28,7/29,7	31,0/31,3	32,7/32,7	34,4/35,6	44,7/45,8
Sound pressure <sup>4)</sup>	Cool / Heat (Hi)	dB(A)	46/47	47/48	48/50	49/51	48/49	49/51	52/54
Dimension <sup>5)</sup>	HxWxD	mm	542x780x289	542x780x289	542x780x289	542x780x289	619x824x299	619x824x299	695x875x320
Net weight		kg	24	25	29	31	35	35	45
Piping diameter	Liquid	Inch (mm)	1/4(6,35)	1/4(6,35)	1/4(6,35)	1/4(6,35)	1/4(6,35)	1/4(6,35)	1/4(6,35)
	Gas	Inch (mm)	3/8(9,52)	3/8(9,52)	3/8(9,52)	1/2(12,70)	1/2(12,70)	1/2(12,70)	5/8(15,88)
Pipe length range		m	3~15	3~15	3~15	3~15	3~20	3~30	3~30
Elevation difference (in / out)		m	15	15	15	15	15	15	20
Pre-charged pipe length		m	7,5	7,5	7,5	7,5	10	10	10
Additional gas amount		g/m	10	10	10	10	15	15	25
Refrigerant (R32) / CO <sub>2</sub> Eq.		kg / T	0,52/0,35	0,61/0,41	0,67/0,45	0,79/0,53	1,07/0,72	1,22/0,82	1,35/0,91
Operating range	Cool Min - Max	°C	-10~+43	-10~+43	-10~+43	-10~+43	-10~+43	-10~+43	-10~+43
	Heat Min - Max	°C	-15~+24	-15~+24	-15~+24	-15~+24	-15~+24	-15~+24	-15~+24

1) EER and COP calculation is based in accordance to EN 14511. 2) Energy Label Scale from A+++ to D. 3) The annual energy consumption is calculated in accordance to EU/626/2011. 4) The sound pressure of the indoor unit shows the value measured of a position of 1 m in front of the main body and 0,8 m below the unit. For outdoor unit 1 m in front and 1 m in rear side of main body. The sound pressure is measured in accordance with JIS C 9612. Q-Lo: Quiet mode. Lo: The lowest set fan speed. 5) Add 70 mm for piping port.

## Accessories

**CZ-CAPRA1** RAC interface adapter for integration into S-Link

## Accessories

**CZ-RD517C** Wired remote controller for wall-mounted and floor console



SEER and SCOP: For KIT-TZ25-ZKE. SUPER QUIET: For KIT-TZ20-ZKE, KIT-TZ25-ZKE and KIT-TZ35-ZKE. INTERNET CONTROL: Built-in Wi-Fi.

### Wall-mounted BZ super-compact · R32

- Compact design with only 779 mm wide
- Cleaner air with PM2,5 Filter
- Super Quiet! Only 20 dB(A)
- Aerowings to control air draft direction
- High energy savings
- Cooling even at -10 °C
- Optional internet and voice control



Optional 



Kit			KIT-BZ25-ZKE	KIT-BZ35-ZKE	KIT-BZ50-ZKE	KIT-BZ60-ZKE
Cooling capacity	Nominal (Min - Max)	kW	2,50 [0,85 - 3,00]	3,30 [0,85 - 3,90]	5,00 [0,98 - 5,40]	6,00 [0,98 - 6,50]
EER <sup>1)</sup>	Nominal (Min - Max)	W/W	3,68 [4,05 - 3,33]	3,24 [3,54 - 3,05]	3,03 [3,92 - 2,90]	3,03 [3,92 - 2,83]
<b>SEER <sup>2)</sup></b>			<b>6,30 A++</b>	<b>6,30 A++</b>	<b>6,50 A++</b>	<b>6,40 A++</b>
Pdesign (cooling)		kW	2,5	3,3	5	6
Input power	Nominal (Min - Max)	kW	0,68 [0,21 - 0,90]	1,02 [0,24 - 1,28]	1,65 [0,25 - 1,86]	1,98 [0,25 - 2,30]
Annual energy consumption <sup>3)</sup>		kWh/a	139	183	269	328
Heating capacity	Nominal (Min - Max)	kW	3,15 [0,80 - 3,60]	3,70 [0,80 - 4,40]	5,40 [0,98 - 7,50]	6,80 [0,98 - 8,00]
Heating capacity at -7 °C		kW	2,14	2,60	4,62	5,1
COP <sup>1)</sup>	Nominal (Min - Max)	W/W	4,09 [4,21 - 3,50]	3,72 [4,10 - 3,49]	3,42 [4,67 - 3,09]	3,16 [4,26 - 3,02]
<b>SCOP <sup>2)</sup></b>			<b>4,30 A+</b>	<b>4,20 A+</b>	<b>4,20 A+</b>	<b>4,10 A+</b>
Pdesign at -10 °C		kW	1,9	2,4	4	4,4
Input power	Nominal (Min - Max)	kW	0,77 [0,19 - 1,03]	1,00 [0,20 - 1,26]	1,58 [0,21 - 2,43]	2,15 [0,23 - 2,65]
Annual energy consumption <sup>3)</sup>		kWh/a	619	800	1333	1502
<b>Indoor unit</b>			<b>CS-BZ25ZKE</b>	<b>CS-BZ35ZKE</b>	<b>CS-BZ50ZKE</b>	<b>CS-BZ60ZKE</b>
Power supply		V	230	230	230	230
Recommended fuse		A	16	16	16	20
Connection indoor / outdoor		mm <sup>2</sup>	4x1,5	4x1,5	4x2,5	4x2,5
Air flow	Cool / Heat	m <sup>3</sup> /min	10,5/9,5	10,8/11,3	12,5/13,2	12,7/13,6
Moisture removal volume		L/h	1,5	1,9	2,8	3,3
Sound pressure <sup>4)</sup>	Cool (Hi / Lo / Q-Lo)	dB(A)	37/26/20	38/30/20	44/37/34	45/37/34
	Heat (Hi / Lo / Q-Lo)	dB(A)	36/27/24	38/33/25	44/37/34	45/37/34
Dimension	H x W x D	mm	290 x 779 x 209	290 x 779 x 209	290 x 779 x 209	290 x 779 x 209
Net weight		kg	8	8	8	9
<b>Outdoor unit</b>			<b>CU-BZ25ZKE</b>	<b>CU-BZ35ZKE</b>	<b>CU-BZ50ZKE</b>	<b>CU-BZ60ZKE</b>
Air flow	Cool / Heat	m <sup>3</sup> /min	30,4/30,4	31,1/30,4	32,7/32,7	42,6/39,2
Sound pressure <sup>4)</sup>	Cool / Heat (Hi)	dB(A)	48/49	48/50	48/49	50/50
Dimension <sup>5)</sup>	H x W x D	mm	542 x 780 x 289	542 x 780 x 289	619 x 824 x 299	695 x 875 x 320
Net weight		kg	24	25	35	40
Piping diameter	Liquid	Inch (mm)	1/4 (6,35)	1/4 (6,35)	1/4 (6,35)	1/4 (6,35)
	Gas	Inch (mm)	3/8 (9,52)	3/8 (9,52)	1/2 (12,70)	1/2 (12,70)
Pipe length range		m	3 ~ 15	3 ~ 15	3 ~ 15	3 ~ 30
Elevation difference (in / out)		m	15	15	15	15
Pre-charged pipe length		m	7,5	7,5	10	7,5
Additional gas amount		g/m	10	10	15	15
Refrigerant (R32) / CO <sub>2</sub> Eq.		kg / T	0,52/0,35	0,61/0,41	1,07/0,72	1,11/0,75
Operating range	Cool Min ~ Max	°C	-10 ~ +43	-10 ~ +43	-10 ~ +43	-10 ~ +43
	Heat Min ~ Max	°C	-15 ~ +24	-15 ~ +24	-15 ~ +24	-15 ~ +24

1) EER and COP calculation is based in accordance to EN 14511. 2) Energy Label Scale from A+++ to D. 3) The annual energy consumption is calculated in accordance to EU/626/2011. 4) The sound pressure of the indoor unit shows the value measured of a position of 1 m in front of the main body and 0,8 m below the unit. For outdoor unit 1 m in front and 1 m in rear side of main body. The sound pressure is measured in accordance with JIS C 9612. Q-Lo: Quiet mode. Lo: The lowest set fan speed. 5) Add 70 mm for piping port.

#### Accessories

<b>CZ-TACG1</b>	Wi-Fi adapter for smart control via Panasonic Comfort Cloud App
<b>CZ-CAPRA1</b>	RAC interface adapter for integration into S-Link

#### Accessories

<b>CZ-RD517C</b>	Wired remote controller for wall-mounted and floor console
------------------	--



SEER: For KIT-BZ50-ZKE. SCOP: For KIT-BZ25-ZKE. SUPER QUIET: For KIT-BZ25-ZKE and KIT-BZ35-ZKE. INTERNET CONTROL: Optional.

Rating conditions: Cooling indoor 27 °C DB / 19 °C WB. Cooling outdoor 35 °C DB / 24 °C WB. Heating indoor 20 °C DB. Heating outdoor 7 °C DB / 6 °C WB. (DB: Dry Bulb; WB: Wet Bulb). Specifications subject to change without notice. For detailed information about ErP / Energy Labelling, please visit our websites [www.aircon.panasonic.eu](http://www.aircon.panasonic.eu) or [www.ptc.panasonic.eu](http://www.ptc.panasonic.eu).

### Wall-mounted UZ super-compact · R32

- Compact design with only 779 mm wide
- Dust Collection Filter
- Super Quiet! Only 20 dB(A)
- Aerowings to control air draft direction
- High energy savings
- Cooling even at -10 °C
- Optional internet and voice control



Optional 



Kit			KIT-UZ25-ZKE	KIT-UZ35-ZKE	KIT-UZ50-ZKE
Cooling capacity	Nominal (Min - Max)	kW	2,50 (0,85 - 3,00)	3,30 (0,85 - 3,90)	5,00 (0,98 - 5,40)
EER <sup>1)</sup>	Nominal (Min - Max)	W/W	3,68 (4,05 - 3,33)	3,24 (3,54 - 3,00)	3,03 (3,92 - 2,89)
<b>SEER <sup>2)</sup></b>			<b>6,20 A++</b>	<b>6,20 A++</b>	<b>6,50 A++</b>
Pdesign (cooling)		kW	2,5	3,3	5
Input power	Nominal (Min - Max)	kW	0,68 (0,21 - 0,90)	1,02 (0,24 - 1,30)	1,65 (0,25 - 1,87)
Annual energy consumption <sup>3)</sup>		kWh/a	141	186	269
Heating capacity	Nominal (Min - Max)	kW	3,15 (0,80 - 3,60)	3,70 (0,80 - 4,40)	5,40 (0,98 - 7,40)
Heating capacity at -7 °C		kW	2,14	2,60	4,52
COP <sup>1)</sup>	Nominal (Min - Max)	W/W	4,06 (4,21 - 3,50)	3,72 (4,10 - 3,46)	3,42 (4,67 - 3,08)
<b>SCOP <sup>2)</sup></b>			<b>4,20 A+</b>	<b>4,10 A+</b>	<b>4,10 A+</b>
Pdesign at -10 °C		kW	1,9	2,4	4
Input power	Nominal (Min - Max)	kW	0,78 (0,19 - 1,03)	1,00 (0,20 - 1,27)	1,58 (0,21 - 2,40)
Annual energy consumption <sup>3)</sup>		kWh/a	633	820	1366
<b>Indoor unit</b>			<b>CS-UZ25ZKE</b>	<b>CS-UZ35ZKE</b>	<b>CS-UZ50ZKE</b>
Power supply		V	230	230	230
Recommended fuse		A	16	16	16
Connection indoor / outdoor		mm <sup>2</sup>	4x1,5	4x1,5	4x2,5
Air flow	Cool / Heat	m <sup>3</sup> /min	10,5/9,5	10,8/11,3	12,5/13,2
Moisture removal volume		L/h	1,5	1,9	2,8
Sound pressure <sup>4)</sup>	Cool (Hi / Lo / Q-Lo)	dB(A)	37/26/20	38/30/20	44/37/34
	Heat (Hi / Lo / Q-Lo)	dB(A)	36/27/24	38/33/25	44/37/34
Dimension	H x W x D	mm	290 x 779 x 209	290 x 779 x 209	290 x 779 x 209
Net weight		kg	8	8	8
<b>Outdoor unit</b>			<b>CU-UZ25ZKE</b>	<b>CU-UZ35ZKE</b>	<b>CU-UZ50ZKE</b>
Air flow	Cool / Heat	m <sup>3</sup> /min	30,4/30,4	31,1/30,4	32,7/32,7
Sound pressure <sup>4)</sup>	Cool / Heat (Hi)	dB(A)	48/49	48/50	48/49
Dimension <sup>5)</sup>	H x W x D	mm	542 x 780 x 289	542 x 780 x 289	619 x 824 x 299
Net weight		kg	24	25	35
Piping diameter	Liquid	Inch (mm)	1/4 (6,35)	1/4 (6,35)	1/4 (6,35)
	Gas	Inch (mm)	3/8 (9,52)	3/8 (9,52)	1/2 (12,70)
Pipe length range		m	3 - 15	3 - 15	3 - 15
Elevation difference (in / out)		m	15	15	15
Pre-charged pipe length		m	7,5	7,5	10
Additional gas amount		g/m	10	10	15
Refrigerant (R32) / CO <sub>2</sub> Eq.		kg / T	0,52/0,35	0,61/0,41	1,07/0,72
Operating range	Cool Min ~ Max	°C	-10 ~ +43	-10 ~ +43	-10 ~ +43
	Heat Min ~ Max	°C	-15 ~ +24	-15 ~ +24	-15 ~ +24

1) EER and COP calculation is based in accordance to EN 14511. 2) Energy Label Scale from A+++ to D. 3) The annual energy consumption is calculated in accordance to EU/626/2011. 4) The sound pressure of the indoor unit shows the value measured of a position of 1 m in front of the main body and 0,8 m below the unit. For outdoor unit 1 m in front and 1 m in rear side of main body. The sound pressure is measured in accordance with JIS C 9612. Q-Lo: Quiet mode. Lo: The lowest set fan speed. 5) Add 70 mm for piping port.

#### Accessories

<b>CZ-TACG1</b>	Wi-Fi adapter for smart control via Panasonic Comfort Cloud App
<b>CZ-CAPRA1</b>	RAC interface adapter for integration into S-Link

#### Accessories

<b>CZ-RD517C</b>	Wired remote controller for wall-mounted and floor console
------------------	--



SEER: For KIT-UZ50-ZKE. SCOP: For KIT-UZ25-ZKE. SUPER QUIET: For KIT-UZ25-ZKE and KIT-UZ35-ZKE. INTERNET CONTROL: Optional.



## Floor console · R32

- nanoe™ X technology to improve protection 24/7 (nanoe X Generator Mark 1)
- Stylish Sky remote controller
- A breakthrough design that integrates perfectly with the most modern environments
- High energy efficiency class A++ SEER and A++ SCOP
- Optional internet and voice control



Kit			KIT-Z25-UFE	KIT-Z35-UFE	KIT-Z50-UFE
Cooling capacity	Nominal (Min - Max)	kW	2,50 [0,85 - 3,40]	3,50 [0,85 - 3,80]	5,00 [0,90 - 5,70]
EER <sup>1)</sup>	Nominal (Min - Max)	W/W	4,81 [3,54 - 3,78]	4,07 [3,54 - 3,73]	3,60 [3,53 - 3,15]
<b>SEER <sup>2)</sup></b>			<b>7,90 A++</b>	<b>8,10 A++</b>	<b>6,70 A++</b>
Pdesign (cooling)		kW	2,50	3,50	5,00
Input power	Nominal (Min - Max)	kW	0,52 [0,24 - 0,90]	0,86 [0,24 - 1,02]	1,39 [0,26 - 1,81]
Annual energy consumption <sup>3)</sup>		kWh/a	111	151	261
Heating capacity	Nominal (Min - Max)	kW	3,40 [0,85 - 5,00]	4,30 [0,85 - 6,00]	5,80 [0,90 - 8,10]
Heating capacity at -7 °C		kW	2,88	3,37	5,03
COP <sup>1)</sup>	Nominal (Min - Max)	W/W	4,47 [3,54 - 3,70]	3,98 [3,54 - 3,43]	3,74 [3,46 - 3,12]
<b>SCOP <sup>2)</sup></b>			<b>4,60 A++</b>	<b>4,60 A++</b>	<b>4,30 A+</b>
Pdesign at -10 °C		kW	2,70	3,20	4,40
Input power	Nominal (Min - Max)	kW	0,76 [0,24 - 1,35]	1,08 [0,24 - 1,75]	1,55 [0,26 - 2,60]
Annual energy consumption <sup>3)</sup>		kWh/a	822	974	1433
<b>Indoor unit</b>			<b>CS-Z25UFEAW</b>	<b>CS-Z35UFEAW</b>	<b>CS-Z50UFEAW</b>
Air flow	Cool / Heat	m <sup>3</sup> /min	9,6/9,9	9,9/10,1	11,6/13,2
Moisture removal volume		L/h	1,5	2,0	2,8
Sound pressure <sup>4)</sup>	Cool (Hi / Lo / Q-Lo)	dB(A)	38/25/20	39/26/20	44/31/27
	Heat (Hi / Lo / Q-Lo)	dB(A)	38/25/19	39/26/19	46/33/29
Dimension	H x W x D	mm	600 x 750 x 207	600 x 750 x 207	600 x 750 x 207
Net weight		kg	13	13	13
nanoe X Generator			Mark 1	Mark 1	Mark 1
<b>Outdoor unit</b>			<b>CU-Z25UBEA</b>	<b>CU-Z35UBEA</b>	<b>CU-Z50UBEA</b>
Power supply		V	230	230	230
Recommended fuse		A	16	16	16
Connection indoor / outdoor		mm <sup>2</sup>	4x1,5	4x1,5	4x1,5
Air flow	Cool / Heat	m <sup>3</sup> /min	28,7/27,2	34,3/33,5	39,7/38,6
Sound pressure <sup>4)</sup>	Cool / Heat (Hi)	dB(A)	46/47	48/48	48/48
Dimension <sup>5)</sup>	H x W x D	mm	542 x 780 x 289	619 x 824 x 299	695 x 875 x 320
Net weight		kg	33	35	43
Piping diameter	Liquid	Inch (mm)	1/4 [6,35]	1/4 [6,35]	1/4 [6,35]
	Gas	Inch (mm)	3/8 [9,52]	3/8 [9,52]	1/2 [12,70]
Pipe length range		m	3 - 20	3 - 20	3 - 30
Elevation difference (in / out)		m	15	15	20
Pre-charged pipe length		m	7,5	7,5	7,5
Additional gas amount		g/m	10	10	15
Refrigerant [R32] / CO <sub>2</sub> Eq.		kg / T	0,88/0,594	0,93/0,628	1,13/0,763
Operating range	Cool Min ~ Max	°C	-10 ~ +43	-10 ~ +43	-10 ~ +43
	Heat Min ~ Max	°C	-15 ~ +24	-15 ~ +24	-15 ~ +24

1) EER and COP calculation is based in accordance to EN 14511. 2) Energy Label Scale from A+++ to D. 3) The annual energy consumption is calculated in accordance to EU/626/2011. 4) The sound pressure of the units shows the value measured of a position 1 m in front of the main body and 1 m above floor. The sound pressure is measured in accordance with JIS C 9612. Q-Lo: Quiet mode. Lo: The lowest set fan speed. 5) Add 70 mm for piping port.

## Accessories

<b>CZ-TACG1</b>	Wi-Fi adapter for smart control via Panasonic Comfort Cloud App
<b>CZ-CAPRA1</b>	RAC interface adapter for integration into S-Link

## Accessories

<b>CZ-RD517C</b>	Wired remote controller for wall-mounted and floor console
------------------	--



SEER and SCOP: For KIT-Z35-UFE. SUPER QUIET: For KIT-Z25-UFE and KIT-Z35-UFE. INTERNET CONTROL: Optional. IF DESIGN AWARD 2019: Floor console awarded with the prestigious IF Design Award 2019.

Rating conditions: Cooling indoor 27 °C DB / 19 °C WB. Cooling outdoor 35 °C DB / 24 °C WB. Heating indoor 20 °C DB. Heating outdoor 7 °C DB / 6 °C WB. (DB: Dry Bulb; WB: Wet Bulb). Specifications subject to change without notice. For detailed information about ErP / Energy Labelling, please visit our websites [www.aircon.panasonic.eu](http://www.aircon.panasonic.eu) or [www.ptc.panasonic.eu](http://www.ptc.panasonic.eu).

### Low static pressure hide-away · R32

- Duct type can be controlled by KNX and Modbus
- Eco mode for 20% energy saving
- Extremely compact indoor units without losing static pressure (only 200 mm high)
- Weekly timer, 42 settings per week
- Easy check mode for failure detection
- Drain pump included



Optional wireless control kit. CZ-RL511D



Optional 



 MORE DUCT TYPE SOLUTIONS IN PACI SECTION

Kit			KIT-Z25-UD3	KIT-Z35-UD3	KIT-Z50-UD3	KIT-Z60-UD3
Cooling capacity	Nominal (Min - Max)	kW	2,50 (0,85 - 3,20)	3,50 (0,85 - 4,00)	5,10 (0,90 - 5,70)	6,00 (0,90 - 6,50)
EER <sup>1)</sup>	Nominal (Min - Max)	W/W	4,31 (3,54 - 3,76)	3,85 (3,54 - 3,36)	3,27 (3,53 - 3,20)	2,94 (3,53 - 2,83)
<b>SEER <sup>2)</sup></b>			<b>5,90 A+</b>	<b>5,80 A+</b>	<b>5,90 A+</b>	<b>5,60 A+</b>
Pdesign (cooling)		kW	2,50	3,50	5,10	6,00
Input power	Nominal (Min - Max)	kW	0,58 (0,24 - 0,85)	0,91 (0,24 - 1,19)	1,56 (0,26 - 1,78)	2,04 (0,26 - 2,30)
Annual energy consumption <sup>3)</sup>		kWh/a	148	211	303	375
Heating capacity	Nominal (Min - Max)	kW	3,20 (0,85 - 4,60)	4,20 (0,85 - 5,10)	6,10 (0,90 - 7,20)	7,00 (0,90 - 8,00)
Heating capacity at -7 °C		kW	2,60	3,00	4,50	5,10
COP <sup>1)</sup>	Nominal (Min - Max)	W/W	4,00 (3,70 - 3,68)	3,82 (3,70 - 3,59)	3,35 (3,46 - 3,27)	3,24 (3,46 - 3,08)
<b>SCOP <sup>2)</sup></b>			<b>4,20 A+</b>	<b>4,10 A+</b>	<b>4,10 A+</b>	<b>4,10 A+</b>
Pdesign at -10 °C		kW	2,60	2,80	4,00	4,60
Input power	Nominal (Min - Max)	kW	0,80 (0,23 - 1,25)	1,10 (0,23 - 1,42)	1,82 (0,26 - 2,20)	2,16 (0,26 - 2,60)
Annual energy consumption <sup>3)</sup>		kWh/a	867	956	1366	1571
<b>Indoor unit</b>			<b>CS-Z25UD3EAW</b>	<b>CS-Z35UD3EAW</b>	<b>CS-Z50UD3EAW</b>	<b>CS-Z60UD3EAW</b>
External static pressure <sup>4)</sup>	Min - Max	Pa	15 - 45	15 - 45	15 - 50	15 - 50
Air flow	Cool / Heat	m <sup>3</sup> /min	10,5/10,5	11,2/11,2	15,3/15,3	15,7/15,7
Moisture removal volume		L/h	1,5	2,0	2,8	3,3
Sound pressure <sup>5)</sup>	Cool (Hi / Lo / Q-Lo)	dB(A)	33/27/24	33/27/24	39/29/26	41/30/27
	Heat (Hi / Lo / Q-Lo)	dB(A)	35/27/24	35/27/24	39/30/27	41/32/29
Dimension	HxWxD	mm	200x750x640	200x750x640	200x750x640	200x750x640
Net weight		kg	19	19	19	19
<b>Outdoor unit</b>			<b>CU-Z25UBEA</b>	<b>CU-Z35UBEA</b>	<b>CU-Z50UBEA</b>	<b>CU-Z60UBEA</b>
Power supply		V	230	230	230	230
Recommended fuse		A	16	16	16	—
Connection indoor / outdoor		mm <sup>2</sup>	4x1,5-2,5	4x1,5-2,5	4x1,5-2,5	—
Air flow	Cool / Heat	m <sup>3</sup> /min	28,7/27,2	34,3/33,5	39,7/38,6	42,6/41,5
Sound pressure <sup>5)</sup>	Cool / Heat (Hi)	dB(A)	46/47	48/48	48/48	49/50
Dimension <sup>6)</sup>	HxWxD	mm	542x780x289	619x824x299	695x875x320	695x875x320
Net weight		kg	33	35	43	43
Piping diameter	Liquid	Inch (mm)	1/4 (6,35)	1/4 (6,35)	1/4 (6,35)	1/4 (6,35)
	Gas	Inch (mm)	3/8 (9,52)	3/8 (9,52)	1/2 (12,70)	1/2 (12,70)
Pipe length range		m	3-20	3-20	3-30	3-30
Elevation difference (in / out)		m	15	15	20	20
Pre-charged pipe length		m	7,5	7,5	7,5	7,5
Additional gas amount		g/m	10	10	15	15
Refrigerant (R32) / CO <sub>2</sub> Eq.		kg / T	0,88 / 0,594	0,93 / 0,628	1,13 / 0,763	1,13 / 0,763
Operating range	Cool Min ~ Max	°C	-10 ~ +43	-10 ~ +43	-10 ~ +43	-10 ~ +43
	Heat Min ~ Max	°C	-15 ~ +24	-15 ~ +24	-15 ~ +24	-15 ~ +24

1) EER and COP calculation is based in accordance to EN 14511. 2) Energy Label Scale from A+++ to D. 3) The annual energy consumption is calculated in accordance to EU/626/2011. 4) The specification listed on the table indicates values under the condition of 25 Pa (2,5 mmAq) which are applied for factory default setting. Change switch on PCB from Hi to S-Hi to have more than 6,0 mmAq. 5) The sound pressure of the indoor unit shows the value measured of a position of 1,5 m below the unit with 1 m duct on the suction side and 2 m duct on the discharge side. For outdoor unit 1 m in front and 1 m in rear side of main body. The sound pressure is measured in accordance with JIS C 9612. 6) Add 100 mm for indoor unit or 70 mm for outdoor unit for piping port.



















Accessories	
<b>CZ-TACG1</b>	Wi-Fi adapter for smart control via Panasonic Comfort Cloud App

Accessories	
<b>CZ-CAPRA1</b>	RAC interface adapter for integration into S-Link
<b>CZ-RL511D</b>	Optional wireless control kit



SEER and SCOP: For KIT-Z25-UD3. INTERNET CONTROL: Optional.

# Compare split solutions

	Indoor unit dimension	Efficiency <sup>1)</sup>	Indoor air quality	Outdoor temperature	Comfort	Super Quiet	Connectivity
<b>Wall-mounted Heatcharge VZ - 2,5 to 3,5 kW</b> 	295 x <b>798</b> x 375	<b>A+++</b> <b>A+++</b>	 nanoe	<b>-10 °C</b> in cooling mode <b>-30 °C</b> in heating mode	Econavi sunlight detection sensor	 <b>18 dB(A)</b>	Optional Wi-Fi CZ-TACG1
<b>Wall-mounted Etherea - 2,0 to 7,1 kW</b> 	295 x <b>870</b> x 229 (295x1040x244 wide model)	<b>A+++</b> <b>A+++</b>	 nanoe X Generator Mark 3	<b>-10 °C</b> in cooling mode <b>-20 °C</b> in heating mode	Aerowings 2.0	 <b>19 dB(A)</b>	<b>Built-in Wi-Fi</b>
<b>Wall-mounted TZ super-compact - 2,0 to 7,1 kW</b> 	290 x <b>779</b> x 209 (295x1040x244 wide model)	<b>A++</b> <b>A++</b>	 nanoe X Generator Mark 1	<b>-10 °C</b> in cooling mode <b>-15 °C</b> in heating mode	Aerowings	 <b>20 dB(A)</b>	<b>Built-in Wi-Fi</b>
<b>Wall-mounted BZ super-compact - 2,5 to 6,0 kW</b> 	290 x <b>779</b> x 209	<b>A++</b> <b>A+</b>	PM2,5 Filter	<b>-10 °C</b> in cooling mode <b>-15 °C</b> in heating mode	Aerowings	 <b>20 dB(A)</b>	Optional Wi-Fi CZ-TACG1
<b>Wall-mounted UZ super-compact - 2,5 to 5,0 kW</b> 	290 x <b>779</b> x 209	<b>A++</b> <b>A+</b>	Dust collection filter	<b>-10 °C</b> in cooling mode <b>-15 °C</b> in heating mode	Aerowings	 <b>20 dB(A)</b>	Optional Wi-Fi CZ-TACG1
<b>Floor console - 2,5 to 5,0 kW</b> 	600 x 750 x 207	<b>A++</b> <b>A++</b>	 nanoe X Generator Mark 1	<b>-10 °C</b> in cooling mode <b>-15 °C</b> in heating mode	Double air flow	 <b>20 dB(A)</b>	Optional Wi-Fi CZ-TACG1
<b>Low static pressure hide-away - 2,5 to 6,0 kW</b> 	200 x 750 x 640	<b>A+</b> <b>A+</b>	Air filter	<b>-10 °C</b> in cooling mode <b>-15 °C</b> in heating mode	Weekly timer	 <b>24 dB(A)</b>	Optional Wi-Fi CZ-TACG1

<sup>1)</sup> Energy efficiency class in 2,5 kW references. \* All data in this chart is applicable in most of the models in each line up, check product specifications to confirm.

# Multi split systems

When the heating and cooling requirements exceed the scope of a single room, Panasonic offers a wide range of options with a multi split solution.



Panasonic multi split systems - a range to suit every need. High flexibility in installation, while reducing aesthetic impact and maximising comfort.

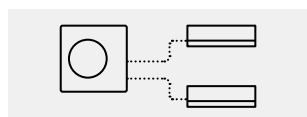

**Multiple indoor units with only one outdoor.**  
Individual control of each indoor.



**Wide range of connectable units.**  
Wall-mounted, floor console and cassette with nanoe™ X.

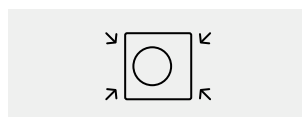

**Seamless integration of outdoor unit.**  
Reduced outdoor unit space, harmonizing with building architecture.



**Reduced installation time.**  
Faster piping connection and pump-down time.

## Why choose a multi split system?

With one indoor unit per room or area with individual control, it is easy to achieve the desired level of comfort throughout the home.

Outside, there is only one unit, which reduces the space required for the outdoor unit, improves the aesthetics of the building and makes installation easier.

Solution with multi split.

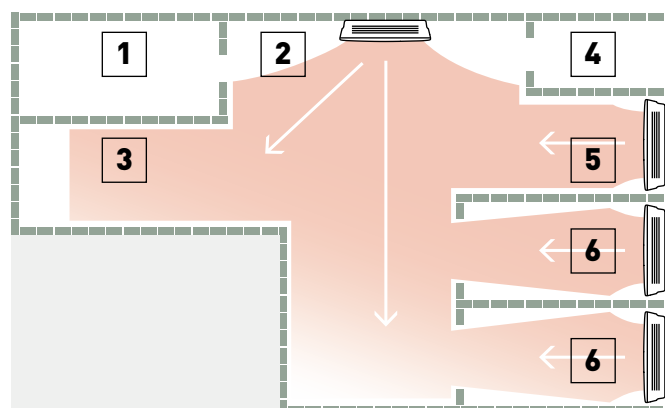

1. Laundry room. 2. Entrance. 3. Kitchen / dining area. 4. Bathroom. 5. Living room. 6. Bedroom.

### Free Multi system. High flexibility for maximising comfort.

Full flexibility up to 9,0 kW and up to 5 ports with wide range of indoor units including high performance Etherea indoor units, reaching up to A+++ / A++.



Up to 5 indoor units  
with only one outdoor.



Wide range of compatible  
indoors with nanoe™ X.

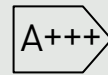

SEER.  
High energy efficiency class.

### Power Heat Multi system. Reliable heating for cold winters.

Powerful heating of two or three rooms with one outdoor unit, even at -25 °C low outdoor temperatures.

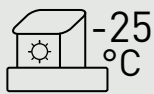

Reliable heating  
even at -25 °C.



Equipped with  
base pan heater.



Excellent  
maintainability.  
Advantageous under harsh  
conditions.

#### -25 °C outdoor temperature operation and base pan heater.

The heater prevents the outdoor unit base pan from freezing and ensures stable operation even in extremely cold regions.

#### Heating capacity at -25 °C outdoor temperature: 3,90 kW for the 2-room model and 4,30 kW for the 3-room model.

Efficiently heats 2 or 3 rooms using a single outdoor unit, even in low outdoor temperatures.

#### High efficiency SCOP 4,60 A++.

High heating efficiency contributes to environmental protection while reducing electricity bills.



#### Dark color outdoor unit.

First outdoor unit in dark color, blending seamlessly with home exteriors without compromising aesthetics.

#### Connectable to Etherea indoor units.

Comfort and convenience with nanoe™ X and built-in Wi-Fi, combined with excellent heating and cooling performance.

### Multi wall TZ system. The super compact multi split solution.

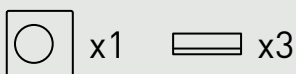

Up to 3 indoor units with  
only one outdoor.



Compact outdoor unit, to minimise  
outdoor unit space.



Compatible with TZ super-  
compact indoor units, with  
nanoe™ X.

# Free Multi system

## Outdoor units Free Multi system - R32

- Up to 5 indoor units with a single outdoor unit
- Up to 5 rooms with individual control
- Etherea, TZ super-compact, floor console and 4 way 60x60 cassette with nanoe™ X technology to improve protection 24/7
- High energy efficiency class A+++ SEER
- Indoor units compatible with internet and voice control

Configure your multi split system in a few steps using our online tool and see all possible combinations.



Outdoor unit			CU-2Z35TBE	CU-2Z41TBE	CU-2Z50TBE	CU-3Z52TBE	CU-3Z68TBE	CU-4Z68TBE	CU-4Z80TBE	CU-5Z90TBE								
Indoor nominal capacity (Min - Max)			3,2 ~ 6,0 kW		3,2 ~ 6,0 kW		3,2 ~ 7,7 kW		4,5 ~ 9,5 kW		4,5 ~ 11,2 kW		4,5 ~ 11,5 kW		4,5 ~ 14,7 kW		4,5 ~ 18,3 kW	
Cooling capacity	Nominal	kW	3,50	4,10	5,00	5,20	6,80	6,80	8,00	9,00								
	Min		1,50	1,50	1,50	1,80	1,90	1,90	3,00	2,90								
	Max		4,50	5,20	5,40	7,30	8,00	8,80	9,20	11,50								
EER <sup>1)</sup>	Nominal	W/W	4,86	4,56	4,24	4,77	3,66	4,39	4,04	4,09								
	Min		6,00	6,00	6,00	—	7,04	5,59	5,66	5,27								
	Max		4,09	3,80	3,62	—	3,38	3,56	3,21	2,98								
<b>SEER <sup>2)</sup></b>			<b>8,50 A+++</b>		<b>8,50 A+++</b>		<b>8,50 A+++</b>		<b>8,50 A+++</b>		<b>8,00 A++</b>		<b>8,00 A++</b>		<b>7,90 A++</b>		<b>8,50 A+++</b>	
Pdesign (cooling)			kW		3,50	4,10	5,00	5,20	6,80	6,80	8,00	9,00						
Input power	Nominal	kW	0,72	0,90	1,18	1,09	1,86	1,55	1,98	2,20								
	Min		0,25	0,25	0,25	0,36	0,27	0,34	0,53	0,55								
	Max		1,10	1,37	1,49	2,18	2,37	2,47	2,87	3,86								
Annual energy consumption <sup>3)</sup>			kWh/a		144	169	206	214	298	298	990	1100						
Heating capacity	Nominal	kW	4,20	4,60	5,60	6,80	8,50	8,50	9,40	10,40								
	Min		1,10	1,10	1,10	1,60	3,30	3,00	4,20	3,40								
	Max		5,60	7,00	7,20	8,30	10,40	10,60	10,60	14,50								
Heating capacity at -7 °C			kW		3,39	4,18	4,28	3,95	4,45	4,45	6,42	8,62						
COP <sup>1)</sup>	Nominal	W/W	4,88	4,79	4,63	4,63	3,95	4,47	4,63	4,84								
	Min		5,24	5,24	5,24	5,00	5,32	5,17	6,00	6,42								
	Max		4,18	3,91	4,00	3,82	3,64	3,96	3,46	3,42								
<b>SCOP <sup>2)</sup></b>			<b>4,60 A++</b>		<b>4,60 A++</b>		<b>4,60 A++</b>		<b>4,20 A+</b>		<b>4,20 A+</b>		<b>4,20 A+</b>		<b>4,70 A++</b>		<b>4,68 A++</b>	
Pdesign at -10 °C			kW		3,20	3,50	4,20	5,00	5,20	5,80	6,80	8,50						
Input power	Nominal	kW	0,86	0,96	1,21	1,47	2,15	1,90	2,03	2,15								
	Min		0,21	0,21	0,21	0,32	0,62	0,58	0,70	0,53								
	Max		1,34	1,79	1,80	2,17	2,86	2,68	3,06	4,24								
Annual energy consumption <sup>3)</sup>			kWh/a		974	1065	1278	1667	1733	1933	2026	2543						
Current			Cool / Heat		A		3,35/4,00	4,15/4,45	5,35/5,50	5,00/6,70	8,40/9,70	7,00/8,60	9,50/9,50	10,50/10,10				
Power supply			V		230		230	230	230	230	230	230						
Recommended fuse			A		16		16	16	16	20	20	25						
Recommended power cable section			mm <sup>2</sup>		2,5		2,5	2,5	2,5	2,5	2,5	4,0						
Sound pressure <sup>4)</sup>			Cool / Heat (Hi)		dB(A)		48/50	48/50	50/52	47/48	51/52	49/50	51/52	53/54				
Dimension <sup>5)</sup>			HxWxD		mm		619x824x299	619x824x299	619x824x299	795x875x320	795x875x320	795x875x320	999x940x340	999x940x340				
Net weight			kg		39		39	39	71	71	72	80	81					
Piping diameter	Liquid	Inch (mm)	1/4 (6,35)		1/4 (6,35)		1/4 (6,35)		1/4 (6,35)		1/4 (6,35)		1/4 (6,35)		1/4 (6,35)			
	Gas	Inch (mm)	3/8 (9,52)		3/8 (9,52)		3/8 (9,52)		3/8 (9,52)		3/8 (9,52)		3/8 (9,52)		3/8 (9,52)			
Pipe length range total <sup>6)</sup>			m		6 ~ 30		6 ~ 30	6 ~ 30	6 ~ 50	6 ~ 60	6 ~ 60	6 ~ 70	6 ~ 80					
Pipe length range to one unit			m		3 ~ 20		3 ~ 20	3 ~ 20	3 ~ 25	3 ~ 25	3 ~ 25	3 ~ 25	3 ~ 25					
Elevation difference (in / out)			m		10		10	10	15	15	15	15						
Pre-charged pipe length			m		20		20	20	30	30	30	45	45					
Additional gas amount			g/m		15		15	15	20	20	20	20						
Refrigerant (R32) / CO <sub>2</sub> Eq.			kg / T		1,12/0,756		1,12/0,756	1,12/0,756	2,10/1,418	2,10/1,418	2,10/1,418	2,72/1,836	2,72/1,836					
Operating range	Cool Min ~ Max		°C		-10 ~ +46		-10 ~ +46	-10 ~ +46	-10 ~ +46	-10 ~ +46	-10 ~ +46	-10 ~ +46	-10 ~ +46					
	Heat Min ~ Max		°C		-15 ~ +24		-15 ~ +24	-15 ~ +24	-15 ~ +24	-15 ~ +24	-15 ~ +24	-15 ~ +24	-15 ~ +24					

1) EER and COP calculation is based in accordance to EN 14511. 2) Energy Label Scale from A+++ to D. 3) The annual energy consumption is calculated in accordance to EU/626/2011. 4) The sound pressure of the units shows the value measured of a position 1 m in front and 1 m in rear side of the main body. The sound pressure is measured in accordance with JIS C 9612. 5) Add 70 or 95 mm for piping port. 6) Minimum piping length is 3 meters per indoor unit.

### Possible outdoor / indoor units combinations

Rooms	Outdoor unit	Indoor capacity connected (Min - Max)	Wall-mounted Etherea							Wall-mounted TZ super-compact							Floor console				4 way 60x60 cassette					Low static pressure hide-away									
			16	20	25	35	42	50	71	16	20	25	35	42	50	60	71	20	25	35	50	20	25	35	50	60	20	25	35	50	60				
2	CU-2Z35TBE	3,2~6,0 kW	•	•	•	•	•					•	•	•	•							• <sup>1)</sup>	• <sup>1)</sup>	• <sup>1)</sup>					•	•	•				
	CU-2Z41TBE	3,2~6,0 kW	•	•	•	•	•					•	•	•	•								• <sup>1)</sup>	• <sup>1)</sup>	• <sup>1)</sup>					•	•	•			
	CU-2Z50TBE	3,2~7,7 kW	•	•	•	•	• <sup>3)</sup>	• <sup>3)</sup>					•	•	•	• <sup>3)</sup>	• <sup>3)</sup>						•	•	•	• <sup>3)</sup>	• <sup>3)</sup>			•	•	•			
3	CU-3Z52TBE	4,5~9,5 kW	•	•	•	•	• <sup>1)</sup>	• <sup>1)</sup>					•	•	•	• <sup>1)</sup>	• <sup>1)</sup>						• <sup>1)</sup>	• <sup>1)</sup>	• <sup>1)</sup>	• <sup>1)</sup>			•	•	•				
	CU-3Z68TBE	4,5~11,2 kW	•	•	•	•	• <sup>1)</sup>	• <sup>1)</sup>					•	•	•	• <sup>1)</sup>	• <sup>1)</sup>						• <sup>1)</sup>	• <sup>1)</sup>	• <sup>1)</sup>	• <sup>1)</sup>	• <sup>2)</sup>		•	•	•				
4	CU-4Z68TBE	4,5~11,5 kW	•	•	•	•	• <sup>1)</sup>	• <sup>1)</sup>					•	•	•	• <sup>1)</sup>	• <sup>1)</sup>						• <sup>1)</sup>	• <sup>1)</sup>	• <sup>1)</sup>	• <sup>1)</sup>	• <sup>2)</sup>		•	•	•				
	CU-4Z80TBE	4,5~14,7 kW	•	•	•	•	• <sup>1)</sup>	• <sup>3)</sup>					•	•	•	• <sup>1)</sup>	• <sup>1)</sup>						• <sup>1)</sup>	• <sup>1)</sup>	• <sup>1)</sup>	• <sup>1)</sup>	• <sup>2)</sup>		•	•	•				
5	CU-5Z90TBE	4,5~18,3 kW	•	•	•	•	• <sup>1)</sup>	• <sup>3)</sup>					•	•	•	• <sup>1)</sup>	• <sup>1)</sup>						• <sup>1)</sup>	• <sup>1)</sup>	• <sup>1)</sup>	• <sup>1)</sup>	• <sup>2)</sup>		•	•	•				

1) Pipe reducer CZ-MA1PA required. 2) Pipe reducer CZ-MA2PA required. 3) Pipe reducers CZ-MA2PA and CZ-MA3PA required.





Optional wired remote controller. CZ-RD517C

INTERNET CONTROL: Built-in Wi-Fi.



Wall-mounted Etherea	Indoor unit graphite grey	Indoor unit silver	Indoor unit matt white	Cooling capacity	Heating capacity	Connection in. / out.	Sound pressure <sup>1)</sup>		Dimension / Net weight	Piping diameter
							Cool — Heat (Hi/Lo/Q-Lo)	dB(A)		
1,6 kW	—	—	CS-MZ16ZKE	1,60	2,60	4x1,5	38/26/21	— 39/27/21	295x870x229/10	1/4(6,35)/3/8(9,52)
2,0 kW	CS-XZ20ZKEW-H	CS-XZ20ZKEW	CS-Z20ZKEW	2,00	3,20	4x1,5	39/26/21	— 40/27/21	295x870x229/10	1/4(6,35)/3/8(9,52)
2,5 kW	CS-XZ25ZKEW-H	CS-XZ25ZKEW	CS-Z25ZKEW	2,50	3,60	4x1,5	41/27/21	— 43/29/21	295x870x229/10	1/4(6,35)/3/8(9,52)
3,5 kW <sup>2)</sup>	CS-XZ35ZKEW-H	CS-XZ35ZKEW	CS-Z35ZKEW	3,50	4,50	4x1,5	44/30/21	— 45/35/21	295x870x229/11	1/4(6,35)/3/8(9,52)
4,2 kW <sup>3)</sup>	CS-XZ42ZKEW-H	—	CS-Z42ZKEW	4,20	5,60	4x1,5	44/33/27	— 45/37/31	295x870x229/10	1/4(6,35)/1/2(12,70)
5,0 kW <sup>4)</sup>	—	CS-XZ50ZKEW	CS-Z50ZKEW	5,00	6,80	4x2,5	44/39/32	— 46/39/32	295x1040x244/12	1/4(6,35)/1/2(12,70)
7,1 kW	—	—	CS-Z71ZKEW	7,10	8,70	4x2,5	49/40/32	— 49/40/32	295x1040x244/13	1/4(6,35)/5/8(15,88)

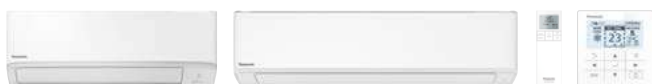

Optional wired remote controller. CZ-RD517C

INTERNET CONTROL: Built-in Wi-Fi.



Wall-mounted TZ super-compact	Indoor unit	Cooling capacity	Heating capacity	Connection in. / out.	Sound pressure <sup>1)</sup>		Dimension / Net weight	Piping diameter
					Cool — Heat (Hi/Lo/Q-Lo)	dB(A)		
1,6 kW	CS-MTZ16ZKE	1,60	2,60	4x1,5	38/27/22	— 39/28/24	290x779x209/8	1/4(6,35)/3/8(9,52)
2,0 kW	CS-TZ20ZKEW	2,00	3,20	4x1,5	37/25/20	— 38/26/22	290x779x209/8	1/4(6,35)/3/8(9,52)
2,5 kW	CS-TZ25ZKEW	2,50	3,60	4x1,5	40/26/20	— 40/27/22	290x779x209/8	1/4(6,35)/3/8(9,52)
3,5 kW <sup>2)</sup>	CS-TZ35ZKEW	3,50	4,50	4x1,5	42/30/20	— 42/33/22	290x779x209/8	1/4(6,35)/3/8(9,52)
4,2 kW	CS-TZ42ZKEW	4,20	5,60	4x1,5	44/31/29	— 44/35/34	290x779x209/8	1/4(6,35)/1/2(12,70)
5,0 kW	CS-TZ50ZKEW	5,00	6,80	4x2,5	44/37/33	— 44/37/33	290x779x209/8	1/4(6,35)/1/2(12,70)
6,0 kW	CS-TZ60ZKEW	6,00	8,50	4x2,5	45/37/34	— 45/37/34	295x1040x244/12	1/4(6,35)/1/2(12,70)
7,1 kW	CS-TZ71ZKEW	7,10	8,70	4x2,5	47/38/35	— 47/38/35	295x1040x244/13	1/4(6,35)/5/8(15,88)



Optional wired remote controller. CZ-RD517C

INTERNET CONTROL: Optional.



Floor console <sup>5)</sup>	Indoor unit	Cooling capacity	Heating capacity	Connection in. / out.	Sound pressure <sup>6)</sup>		Dimension / Net weight	Piping diameter
					Cool — Heat (Hi/Lo/Q-Lo)	dB(A)		
2,0 kW	CS-MZ20UFEA	2,00	3,20	4x1,5	39/27/22	— 39/27/21	600x750x207/13	1/4(6,35)/3/8(9,52)
2,5 kW	CS-Z25UFEAW	2,50	3,60	4x1,5	40/27/22	— 40/27/21	600x750x207/13	1/4(6,35)/3/8(9,52)
3,5 kW <sup>2)</sup>	CS-Z35UFEAW	3,50	4,50	4x1,5	41/28/22	— 41/28/21	600x750x207/13	1/4(6,35)/3/8(9,52)
5,0 kW	CS-Z50UFEAW	5,00	5,30	4x1,5	44/33/29	— 48/35/31	600x750x207/13	1/4(6,35)/1/2(12,70)

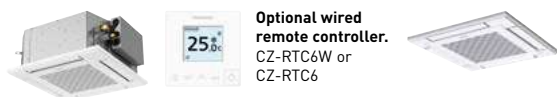

Optional wired remote controller. CZ-RT6W or CZ-RTC6

Panel (sold separately). CZ-KPY4

INTERNET CONTROL and BMS CONNECTIVITY: Optional.



4 way 60x60 cassette*	Indoor unit (Panel CZ-KPY4)	Cooling capacity	Heating capacity	Connection in. / out.	Sound pressure <sup>7)</sup>		Dimension / Net weight		Piping diameter
					Cool — Heat (Hi/Lo/Q-Lo)	dB(A)	Indoor HxWxD	Panel HxWxD	
2,0 kW	S-M20PY3E	2,00	3,20	4x1,5	33/30/27	— 33/30/27	243x575x575/15	30x625x625/2,8	1/4(6,35)/1/2(12,70)
2,5 kW	S-25PY3E	2,50	3,60	4x1,5	33/30/27	— 33/30/27	243x575x575/15	30x625x625/2,8	1/4(6,35)/1/2(12,70)
3,5 kW <sup>2)</sup>	S-36PY3E	3,50	3,60	4x1,5	36/32/27	— 36/32/27	243x575x575/15	30x625x625/2,8	1/4(6,35)/1/2(12,70)
5,0 kW <sup>4)</sup>	S-50PY3E	5,00	6,80	4x1,5	41/36/29	— 41/36/29	243x575x575/15	30x625x625/2,8	1/4(6,35)/1/2(12,70)
6,0 kW	S-60PY3E	6,00	8,50	4x1,5	45/39/33	— 45/39/33	243x575x575/15	30x625x625/2,8	3/8(9,52)/5/8(15,88)

\* Compatible with Commercial control and connectivity accessories only. For detailed information go to the control systems section.



Optional wireless control kit. CZ-RL511D

INTERNET CONTROL and BMS CONNECTIVITY: Optional.



Low static pressure hide-away	Indoor unit	Cooling capacity	Heating capacity	Connection in. / out.	Sound pressure <sup>8)</sup>		Dimension / Net weight	Piping diameter
					Cool — Heat (Hi/Lo/Q-Lo)	dB(A)		
2,0 kW	CS-MZ20UD3EA	2,00	3,20	4x1,5	34/29/26	— 36/29/26	200x750x640/19	1/4(6,35)/3/8(9,52)
2,5 kW	CS-Z25UD3EAW	2,50	3,60	4x1,5	35/29/26	— 37/29/26	200x750x640/19	1/4(6,35)/3/8(9,52)
3,5 kW <sup>2)</sup>	CS-Z35UD3EAW	3,50	4,50	4x1,5	35/29/26	— 37/29/26	200x750x640/19	1/4(6,35)/3/8(9,52)
5,0 kW <sup>4)</sup>	CS-Z50UD3EAW	5,00	6,80	4x1,5	41/31/28	— 41/32/29	200x750x640/19	1/4(6,35)/1/2(12,70)
6,0 kW	CS-Z60UD3EAW	6,00	8,50	4x1,5	43/32/29	— 43/34/31	200x750x640/19	1/4(6,35)/1/2(12,70)

1) The sound pressure of the indoor unit shows the value measured of a position of 1 m in front of the main body and 0,8 m below the unit. The sound pressure is measured in accordance with JIS C 9612. Q-Lo: Quiet mode. Lo: The lowest set fan speed. 2) Heating capacity in combination with Free Multi outdoor units except with CU-Z235TBE. In this case, the heating capacity is 4,20 kW. 3) Heating capacity in combination with Free Multi outdoor units except with CU-Z250TBE. In this case, the heating capacity is 5,00 kW. 4) Heating capacity in combination with Free Multi outdoor units except with CU-Z235TBE. In this case, the heating capacity is 5,30 kW. 5) Compatible only with 2 ports R32 outdoor CU-Z235TBE / CU-Z241TBE / CU-Z250TBE. Minimum quantity of connection: 2 indoor units. 6) The sound pressure of the units shows the value measured of a position 1 m in front of the main body and 1 m above floor. The sound pressure is measured in accordance with JIS C 9612. Q-Lo: Quiet mode. Lo: The lowest set fan speed. 7) The sound pressure of the indoor unit shows the value measured of a position of 1,5 m below the unit. The sound pressure is measured in accordance with JIS C 9612. Q-Lo: Quiet mode. Lo: The lowest set fan speed. 8) The sound pressure of the indoor unit shows the value measured of a position of 1,5 m below the unit with 1 m duct on the suction side and 2 m duct on the discharge side. The sound pressure is measured in accordance with JIS C 9612.

# Power Heat Multi system

# POWER HEAT

## Outdoor units Power Heat Multi system - R32

- Operation range down to -25 °C
- Equipped with base pan heater
- High energy efficiency: SCOP of 4,60
- Etherea indoor units with nanoe™ X technology to improve protection 24/7
- Indoor units with built-in Wi-Fi for internet and voice control



### Tentative data

Outdoor unit			CU-2Z50ABEC	CU-3Z75ABEC
<b>Indoor nominal capacity</b>			<b>4,0 ~ 8,5 kW (2 room)</b>	<b>4,5 ~ 11,0 kW (3 room)</b>
Cooling capacity	Nominal (Min - Max)	kW	5,30 (2,10 - 7,50)	7,50 (2,10 - 8,80)
EER <sup>1)</sup>			4,21	3,87
<b>SEER <sup>2)</sup></b>			<b>8,00 A++</b>	<b>8,00 A++</b>
Pdesign (cooling)		kW	5,30	7,50
Input power	Nominal (Min - Max)	kW	1,26 (0,36 - 2,06)	1,94 (0,38 - 2,45)
Heating capacity	Nominal (Min - Max)	kW	6,40 (1,70 - 8,70)	8,60 (1,70 - 10,60)
COP <sup>1)</sup>			4,18	4,26
Heating capacity at -15 °C	Max	kW	5,90	6,30
Heating capacity at -25 °C	Max	kW	3,90	4,30
<b>SCOP <sup>2)</sup></b>			<b>4,40 A+</b>	<b>4,60 A++</b>
Pdesign at -10 °C		kW	5,10	5,60
Input power	Nominal (Min - Max)	kW	1,53 (0,32 - 2,44)	2,02 (0,32 - 2,92)
Current	Heat / Cool	A	6,80 / 5,70	8,80 / 8,50
Power supply		V	230	230
Sound pressure <sup>3)</sup>	Heat / Cool (Hi)	dB(A)	49 / 49	53 / 49
Dimension <sup>4)</sup>	HxWxD	mm	795 x 875 x 320	795 x 875 x 320
Net weight		kg	58	62
Piping diameter	Liquid	Inch (mm)	1/4 (6,35)	1/4 (6,35)
	Gas	Inch (mm)	3/8 (9,52)	3/8 (9,52)
Pipe length range total		m	50	60
Pipe length range to one unit		m	3 ~ 25	3 ~ 25
Elevation difference (in / out)		m	15	15
Pre-charged pipe length		m	30	30
Additional gas amount		g/m	20	20
Refrigerant (R32) / CO <sub>2</sub> Eq.		kg / T	1,92 / 1,296	2,42 / 1,634
Operating range	Heat Min ~ Max	°C	-25 ~ +24	-25 ~ +24
	Cool Min ~ Max	°C	-10 ~ +46	-10 ~ +46

1) EER and COP calculation is based in accordance to EN 14511. 2) Energy Label Scale from A+++ to D. 3) The sound pressure of the units shows the value measured of a position 1 m in front and 1 m in rear side of the main body. The sound pressure is measured in accordance with JIS C 9612. 4) Add 70 or 95 mm for piping port.



### Possible outdoor / indoor units combinations

Rooms	Outdoor unit	Indoor capacity connected (Min - Max)	Wall-mounted Etherea			
			20	25	35	50
2	CU-2Z50ABEC	4,0 ~ 8,5 kW	•	•	•	•
3	CU-3Z75ABEC	4,5 ~ 11,0 kW	•	•	•	•



Optional wired remote controller. CZ-RD517C

INTERNET CONTROL: Built-in Wi-Fi.



Wall-mounted Etherea	Indoor unit graphite grey	Indoor unit silver	Indoor unit matt white	Cooling capacity	Heating capacity	Connection in. / out.	Sound pressure <sup>1)</sup>	Dimension / Net weight	Piping diameter
				kW	kW		mm <sup>2</sup>	Cool — Heat (Hi/Lo/Q-Lo) dB(A)	HxWxD mm / kg
2,0 kW	CS-XZ20ZKEW-H	CS-XZ20ZKEW	CS-Z20ZKEW	2,00	3,20	4x1,5	37/26/21 — 38/27/21	295x870x229/10	1/4 (6,35) / 3/8 (9,52)
2,5 kW	CS-XZ25ZKEW-H	CS-XZ25ZKEW	CS-Z25ZKEW	2,50	3,60	4x1,5	41/27/21 — 41/29/21	295x870x229/10	1/4 (6,35) / 3/8 (9,52)
3,5 kW	CS-XZ35ZKEW-H	CS-XZ35ZKEW	CS-Z35ZKEW	3,50	4,50	4x1,5	44/30/21 — 45/35/21	295x870x229/11	1/4 (6,35) / 3/8 (9,52)
5,0 kW	—	CS-XZ50ZKEW	CS-Z50ZKEW	5,00	6,80	4x2,5	44/39/32 — 46/39/32	295x1040x244/12	1/4 (6,35) / 1/2 (12,70)

1) The sound pressure of the indoor unit shows the value measured of a position of 1 m in front of the main body and 0,8 m below the unit. The sound pressure is measured in accordance with JIS C 9612. Q-Lo: Quiet mode. Lo: The lowest set fan speed.



# Multi wall TZ system

## Outdoor units Multi wall TZ system - R32

- Up to 3 indoor units with a single outdoor unit
- Up to 3 rooms with individual control
- High energy efficiency class A++ SEER
- Flexible installation, compact units and large connection distance
- Indoor units compatible with internet and voice control



Outdoor unit			CU-2TZ41TBE	CU-2TZ50TBE	CU-3TZ52TBE	
<b>Indoor nominal capacity (Min - Max)</b>			<b>3,2 ~ 6,0 kW</b>		<b>4,5 ~ 9,5 kW</b>	
Cooling capacity	Nominal (Min - Max)	kW	4,10 (1,50 - 4,70)	5,00 (1,50 - 5,40)	5,20 (1,80 - 6,60)	
EER <sup>1)</sup>	Nominal (Min - Max)	W/W	4,14 (5,56 - 3,41)	3,85 (5,56 - 3,33)	4,52 (3,67 - 5,00)	
<b>SEER <sup>2)</sup></b>			<b>7,10 A++</b>		<b>7,00 A++</b>	
Pdesign (cooling)		kW	4,10	5,00	5,20	
Input power	Nominal (Min - Max)	kW	0,99 (0,27 - 1,38)	1,30 (0,27 - 1,62)	1,15 (0,36 - 1,80)	
Annual energy consumption <sup>3)</sup>		kWh/a	202	250	239	
Heating capacity	Nominal (Min - Max)	kW	4,40 (1,10 - 6,30)	5,70 (1,10 - 6,40)	6,80 (1,60 - 7,50)	
Heating capacity at -7 °C		kW	3,75	3,80	—	
COP <sup>1)</sup>	Nominal (Min - Max)	W/W	4,44 (5,00 - 3,54)	4,35 (5,00 - 3,62)	4,28 (3,87 - 5,00)	
<b>SCOP <sup>2)</sup></b>			<b>4,30 A+</b>		<b>4,20 A+</b>	
Pdesign at -10 °C		kW	3,50	4,50	5,00	
Input power	Nominal (Min - Max)	kW	0,99 (0,22 - 1,78)	1,31 (0,22 - 1,77)	1,59 (0,32 - 1,94)	
Annual energy consumption <sup>3)</sup>		kWh/a	1139	1500	1667	
Current	Cool / Heat	A	4,60 / 4,60	6,00 / 6,00	5,30 / 7,30	
Power supply		V	230	230	230	
Sound pressure <sup>4)</sup>	Cool / Heat (Hi)	dB(A)	48 / 50	50 / 52	48 / 48	
Dimension <sup>5)</sup>	H x W x D	mm	542 x 780 x 289	542 x 780 x 289	795 x 875 x 320	
Net weight		kg	35	35	71	
Piping diameter	Liquid	Inch (mm)	1/4 (6,35)	1/4 (6,35)	1/4 (6,35)	
	Gas	Inch (mm)	3/8 (9,52)	3/8 (9,52)	3/8 (9,52)	
Pipe length range total		m	6 ~ 30	6 ~ 30	6 ~ 50	
Pipe length range to one unit		m	3 ~ 20	3 ~ 20	3 ~ 25	
Elevation difference (in / out)		m	10	10	15	
Pre-charged pipe length		m	20	20	30	
Additional gas amount		g/m	15	15	20	
Refrigerant (R32) / CO <sub>2</sub> Eq.		kg / T	0,9 / 0,6075	0,9 / 0,6075	2,1 / 1,4175	
Operating range	Cool Min ~ Max	°C	-10 ~ +46	-10 ~ +46	-10 ~ +46	
	Heat Min ~ Max	°C	-15 ~ +24	-15 ~ +24	-15 ~ +24	

1) EER and COP calculation is based in accordance to EN 14511. 2) Energy Label Scale from A+++ to D. 3) The annual energy consumption is calculated in accordance to EU/626/2011. 4) The sound pressure of the units shows the value measured of a position 1 m in front and 1 m in rear side of the main body. The sound pressure is measured in accordance with JIS C 9612. 5) Add 70 or 95 mm for piping port.



## Possible outdoor / indoor units combinations

Rooms	Outdoor unit	Indoor capacity connected (Min - Max)	Wall-mounted TZ super-compact					
			16	20	25	35	42	50
2	CU-2TZ41TBE	3,2 ~ 6,0 kW	•	•	•	•		
	CU-2TZ50TBE	3,2 ~ 7,7 kW	•	•	•	•	•	•
3	CU-3TZ52TBE	4,5 ~ 9,5 kW	•	•	•	•	•	•

Minimum quantity of connection: 2 indoor units.



Optional wired remote controller. CZ-RD517C



Wall-mounted TZ super-compact	Indoor unit	Cooling capacity	Heating capacity	Connection in. / out.	Sound pressure <sup>1)</sup>		Dimension / Net weight	Piping diameter	
					Cool — Heat (Hi/Lo/Q-Lo)			Liquid / Gas	
					dB(A)		mm / kg		Inch (mm)
1,6 kW	CS-MTZ16ZKE	1,60	2,60	4x1,5	38/27/22 — 39/28/24		290x779x209/8		1/4 (6,35) / 3/8 (9,52)
2,0 kW	CS-TZ20ZKEW	2,00	3,20	4x1,5	37/25/20 — 38/26/22		290x779x209/8		1/4 (6,35) / 3/8 (9,52)
2,5 kW	CS-TZ25ZKEW	2,50	3,60	4x1,5	40/26/20 — 40/27/22		290x779x209/8		1/4 (6,35) / 3/8 (9,52)
3,5 kW	CS-TZ35ZKEW	3,50	4,50	4x1,5	42/30/20 — 42/33/22		290x779x209/8		1/4 (6,35) / 3/8 (9,52)
4,2 kW	CS-TZ42ZKEW	4,20	5,60	4x1,5	44/31/29 — 44/35/34		290x779x209/8		1/4 (6,35) / 1/2 (12,70)
5,0 kW	CS-TZ50ZKEW	5,00	6,80	4x2,5	44/37/33 — 44/37/33		290x779x209/8		1/4 (6,35) / 1/2 (12,70)

1) The sound pressure of the indoor unit shows the value measured of a position of 1 m in front of the main body and 0,8 m below the unit. The sound pressure is measured in accordance with JIS C 9612. Q-Lo: Quiet mode. Lo: The lowest set fan speed.

Rating conditions: Cooling indoor 27 °C DB / 19 °C WB. Cooling outdoor 35 °C DB / 24 °C WB. Heating indoor 20 °C DB. Heating outdoor 7 °C DB / 6 °C WB. (DB: Dry Bulb; WB: Wet Bulb). Specifications subject to change without notice. For detailed information about ErP / Energy Labelling, please visit our websites [www.aircon.panasonic.eu](http://www.aircon.panasonic.eu) or [www.ptc.panasonic.eu](http://www.ptc.panasonic.eu).

# RAC Solo, the compact air conditioner without outdoor unit

A high-efficiency RAC Solo with a hyper-compact design that minimises aesthetic impact. Just 16,5 cm deep, easy to install and with DC Inverter technology to optimise performance.



## Seamless integration, indoors and outdoors



**Slim and compact full metal body.**  
Only 16,5 cm deep (indoor).



**No outdoor unit.**  
Just two 162 mm holes\*.  
\* 202 mm for the biggest capacity.



**Easy to install.**  
Stand-alone unit with no refrigerant connections.

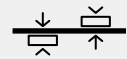

**Self-closing grille.**  
Open only during operation.

## Easy and flexible installation, without outdoor unit

The RAC Solo range offers great installation flexibility as it is a stand-alone unit with no refrigerant connections during installation. The outdoor unit is replaced by two holes in the wall.

All you need is a perimeter wall, to exchange air with the outside. The unit can be placed high on the wall or low on the floor.

### Down installation.

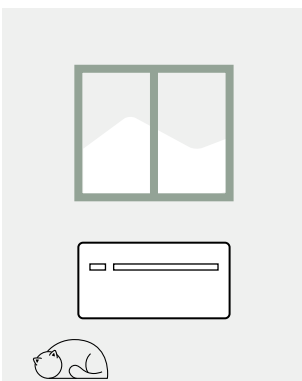

### Overhead installation.

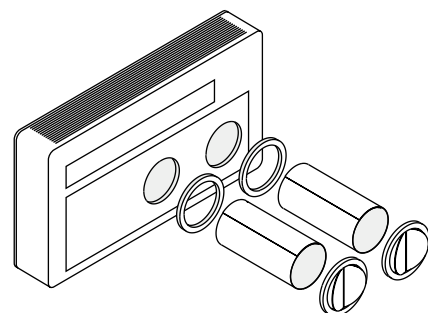
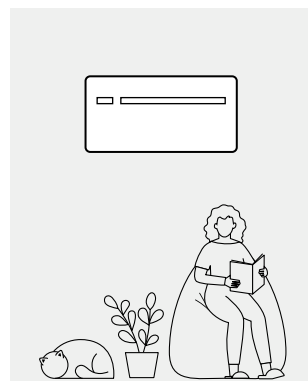

## RAC Solo - R290 / R32

- Slim and compact, only 165 mm deep
- No outdoor unit
- Heating and cooling or cooling only modes available
- DC Inverter technology
- No frost system, with preheated condenser water tray
- Easy and flexible installation
- Wi-Fi control via the Aquarea Home App



Kit matt white			P-MOG16IC5-E	P-MOZ20IC5-E	P-MOZ25IC5-E	P-MOZ30IC5-E
Cooling capacity	Nominal (Min - Max)	kW	1,73 [0,70 - 2,35]	2,09 [0,83 - 2,64]	2,33 [0,92 - 3,10]	2,87 [1,40 - 3,50]
<b>EER <sup>1)</sup></b>	<b>W/W</b>		<b>3,01 A</b>	<b>3,29 A+</b>	<b>3,25 A+</b>	<b>2,74 A</b>
SEER <sup>2)</sup>			4,60	4,70	4,60	4,10
Input power		kW	0,57	0,64	0,73	1,04
Heating capacity	Nominal (Min - Max)	kW	1,71 [0,75 - 2,40]	2,08 [0,71 - 2,64]	2,31 [0,79 - 3,05]	2,75 [1,35 - 3,50]
Heating capacity at -7 °C		kW	1,13	1,37	1,52	1,81
<b>COP <sup>1)</sup></b>	<b>W/W</b>		<b>3,15 A</b>	<b>3,31 A+</b>	<b>3,28 A+</b>	<b>3,12 A</b>
SCOP <sup>2)</sup>			3,70	3,80	3,70	3,40
Input power		kW	0,54	0,63	0,71	0,88
Power supply		V	230	230	230	230
Maximum current		A	3,90	4,10	4,60	6,30
Air flow	Max / Average / Min	m <sup>3</sup> /min	6,0/5,0/4,0	6,3/5,2/4,3	6,7/5,3/4,5	7,5/5,8/5,0
External air flow	Max / Average / Min	m <sup>3</sup> /min	7,2/6,0/5,3	7,7/6,3/5,5	8,0/6,5/5,7	9,2/7,7/6,7
Moisture removal volume		L/h	0,7	0,8	0,9	1,2
Sound pressure <sup>3)</sup>	Hi / Lo / Q-Lo	dB(A)	39/29/27	39/30/26	41/31/27	43/33/29
Outside sound pressure <sup>3)</sup>	Hi / Lo	dB(A)	49/36	49/36	51/38	53/40
Refrigerant / charge		kg	R290 / 0,14	R32 / 0,5	R32 / 0,5	R32 / 0,5
Dimension	HxWxD	mm	549x810x165	549x1010x165	549x1010x165	549x1010x165
Net weight		kg	38	41	41	41
Wall hole diameter		mm	162	162	162	202
Distance between wall holes		mm	293	293	293	293
Operating range	Cool Min ~ Max	°C	-5 ~ +43	-5 ~ +43	-5 ~ +43	-5 ~ +43
	Heat Min ~ Max	°C	-15 ~ +18	-15 ~ +18	-15 ~ +18	-15 ~ +18

1) EER and COP in accordance to 626/2011. Scale A+++ to D. 2) SEER and SCOP in accordance to EN 14511. 3) The sound pressure shows the value measured at 2 m, according to ISO 7779.

### Accessories

<b>PCZ-GB0738</b>	Kit of external aluminium grids with fixed fins (162 mm holes)
<b>PCZ-GB1091</b>	Kit of external aluminium grids with fixed fins (202 mm holes)
<b>PCZ-GB0755</b>	Insect protection kit (1 metal mesh, 1 grid in metal wire and fixing accessories)
<b>PCZ-L00773</b>	Side exit formwork for corner installation (right-hand outlet)

\* Check availability.

### Accessories

<b>PCZ-L00774</b>	Side exit formwork for corner installation (left-hand outlet)
<b>PCZ-GB0737</b>	Bottom cover kit for overhead installation for P-MOZ20/25/30IC5-E
<b>PCZ-GB1105</b>	Bottom cover kit for overhead installation for P-MOG16IC5-E
<b>PCZ-GB1119</b>	Condensate drain pipe heater kit*





































The side installation kit, which must be embedded in the wall, allows the air flow to be redirected sideways for greater installation flexibility.



R290: For P-MOG16IC5-E. R32: For P-MOZ20IC5-E, P-MOZ25IC5-E and P-MOZ30IC5-E.

Rating conditions: Cooling indoor 27 °C DB / 19 °C WB. Cooling outdoor 35 °C DB / 24 °C WB. Heating indoor 20 °C DB. Heating outdoor 7 °C DB / 6 °C WB. (DB: Dry Bulb; WB: Wet Bulb). Specifications subject to change without notice. For detailed information about ErP / Energy Labelling, please visit our websites [www.aircon.panasonic.eu](http://www.aircon.panasonic.eu) or [www.ptc.panasonic.eu](http://www.ptc.panasonic.eu).

# Single split feature overview

Models	Wall-mounted Heatcharge VZ · R32	Wall-mounted Etherea · R32	Wall-mounted TZ super-compact · R32	Wall-mounted BZ super-compact · R32	Wall-mounted UZ super-compact · R32	Floor console · R32	Low static pressure hide-away · R32
 Refrigerant R32	✓	✓	✓	✓	✓	✓	✓
 Econavi. Sunlight sensor	✓						
 Inverter+ system	✓	✓				✓	
 Inverter system			✓	✓	✓		✓
 R2 rotary compressor	✓	✓	✓	✓	✓	✓	✓
 nanoe X Generator	✓ nanoe™	✓ Mark 3	✓ Mark 1			✓ Mark 1	
 PM2,5 Filter				✓			
 Dust collection filter					✓		
 Antiallergy properties	✓	✓	✓			✓	
 Super Quiet <sup>1)</sup>	✓	✓ 19 dB(A) for 2,0, 2,5 and 3,5 kW	✓ 20 dB(A) for 2,0, 2,5 and 3,5 kW	✓ 20 dB(A) for 2,5 and 3,5 kW	✓ 20 dB(A) for 2,5 and 3,5 kW	✓ 20 dB(A) for 2,5 and 3,5 kW	
 Inside cleaning		✓					
 Mild Dry cooling		✓					
 Aerowings		✓	✓	✓	✓		
 Down to -10 °C in cooling only	✓	✓	✓	✓	✓	✓	✓
 Down to -15 °C in heating mode	✓ -35 °C <sup>2)</sup>	✓ -20 °C	✓	✓	✓	✓	✓
 Summer House	✓						
 R410A/R22 Renewal	✓	✓	✓	✓	✓	✓	✓
 Odour-removing function	✓	✓	✓	✓	✓	✓	✓
 Removable, washable panel	✓	✓	✓	✓	✓	✓	
 Powerful mode	✓	✓	✓	✓	✓	✓	✓
 Soft dry operation mode	✓	✓	✓	✓	✓	✓	✓
 Personal air flow creation	✓	✓	✓ For 6,0 and 7,1 kW				
 Automatic vertical air flow control			✓ For 2,0, 2,5, 3,5, 4,2 and 5,0 kW	✓	✓	✓	
 Manual horizontal air flow control			✓ For 2,0, 2,5, 3,5, 4,2 and 5,0 kW	✓	✓	✓	
 Auto mode	✓	✓	✓	✓	✓	✓	✓
 Hot start mode	✓	✓	✓	✓	✓	✓	✓
 Real time clock with dual ON / OFF timer	✓	✓	✓	✓	✓	✓	
 Weekly timer							✓
 LCD infrared remote controller	✓	✓	✓	✓	✓	✓	
 Automatic restart	✓	✓	✓	✓	✓	✓	✓
 Long piping	✓ 15 m	✓ 15 m, 30 m (5,0 and 7,1 kW)	✓ 15 m, 20 m (5,0 kW), 30 m (7,1 and 6,0 kW)	✓ 15 m, 30 m (6,0 kW)	✓ 15 m	✓ 20 m, 30 m (5,0 kW)	✓ 20 m, 30 m (5,0 and 6,0 kW)
 Top-Panel maintenance access	✓	✓	✓	✓	✓	✓	✓
 Self-diagnosis function	✓	✓	✓	✓	✓	✓	✓
 RAC interface adapter for integration into S-Link	✓	✓	✓	✓	✓	✓	✓
 Wi-Fi control	✓	✓ Built-in	✓ Built-in	✓	✓	✓	✓
 Easy control by BMS	✓	✓	✓	✓	✓	✓	✓
 Warranty on the compressor	✓	✓	✓	✓	✓	✓	✓

1) At the lowest fan speed. 2) Tested by 3rd party laboratory, SP, according to EN 14511:2013 and SP Method 1721, this temperature is not guaranteed by Factory.

# Features explained

## Energy saving

### R32

REFRIGERANT

#### Refrigerant R32.

Our heat pumps containing R32 refrigerant show a drastic reduction in the value of Global Warming Potential (GWP). An important step to reduce greenhouse gases. R32 is also a component refrigerant, making it easy to recycle.



#### Inverter Plus system.

Inverter Plus system classification highlights Panasonic's highest performing systems.



#### Panasonic R2 rotary compressor.

Designed to withstand extreme conditions, it delivers high performance and efficiency.

### 38%

ECONAVI

#### Econavi. Sunlight sensor.

Sunlight Sensor technology can detect and reduce the waste of energy by optimising air conditioner operation according to room conditions. With just one touch of a button, you can save energy.



#### Inverter.

The Inverter range provides greater efficiency and comfort. Provides more precise temperature control, without highs and lows, and keeps the ambient temperature constant with lower energy consumption and a significant reduction in noise and vibration levels.

## High performance and indoor air quality



#### nanoe™ X.

Technology with the benefits of hydroxyl radicals has the capacity to inhibit pollutants, viruses, and bacteria to clean and deodorise.



#### Summer House.

This innovative function keeps the house at 8/10 or 8/15 °C to avoid freezing pipes during the winter. This function is beneficial for summer or weekend homes.



#### PM2.5 filter.

This filter can capture airborne particulate matter (PM2.5), including hazardous pollutants, as well as house dust and pollen.



#### R22/R410A Renewal.

The Panasonic renewal system allows good quality existing R410A or R22 pipe work to be re-used whilst installing high efficiency R32 systems.



#### Dust collection filter.

This filter collects and retains particles suspended in the air, resulting in cleaner air in the room.



#### Odour-removing function.

Allows the exchanger to be cleaned, preventing possible odours. While this function is connected, the fan also remains OFF momentarily to avoid unpleasant odours while the exchanger is being cleaned.



#### Antiallergy properties.

System is equipped with antiallergy properties filter.



#### Inside cleaning.

This function works to dry the inside of the indoor unit with nanoe™ X. It can inhibit certain adhered bacteria, viruses and mould with up to 99% efficiency.



#### Removable, washable panel.

The front panel is easy to keep clean. It can be removed quickly in one single step and can be washed in water. A clean front panel ensures smoother, more efficient operation, which can save energy.



#### Super Quiet.

Thanks to its latest generation compressor and its twin blade fan, our outdoor unit is one of the most silent on the market. The indoor unit emits an almost imperceptible 18 dB(A).



#### Powerful mode.

The rapid and effective powerful mode is ideal for when you come home on the hottest or coldest days. It works at maximum power to reach the desired temperature in just 15 minutes.



#### Mild Dry cooling.

Fine control helps prevent a rapid decrease in room humidity while maintaining the set temperature. Maintains an RH\* up to 10% higher than cooling operation (\*RH: Relative Humidity). Ideal when sleeping with the air conditioner on.



#### Soft Dry operation mode.

The soft dry mode eliminates excess moisture with a soft breeze and provides a sense of wellbeing without much change in temperature.



#### Aerowings.

Panasonic's Aerowings feature incorporates two blades that concentrate the air flow to cool or heat in the shortest possible time by distributing the air evenly throughout the room.



#### Personal air flow creation.

Permits the air direction to be adjusted vertically and horizontally. This feature can be conveniently selected by remote controller.



#### Down to -10 °C in cooling mode.

The air conditioner works in cooling mode when the outdoor temperature of -10 °C.



#### Automatic vertical air flow control.

The flap swings up and down automatically. The flow can also be set at a fixed angle with the remote controller.



#### Down to -15 °C in heating mode.

The air conditioner works in heat pump mode when the outdoor temperature is as low as -15 °C.



#### Manual horizontal air flow control.

## High connectivity



#### Domestic integration to S-Link - CZ-CAPRA1.

Can connect RAC range to S-Link. Full control is now possible.



#### Wi-Fi control.

The Panasonic Comfort Cloud App allows users to conveniently manage and monitor Panasonic residential heat pumps from a mobile device, anytime, anywhere.



#### BMS connectivity.

The communication port can be integrated into the indoor unit and provides easy connection to, and control of, your Panasonic air conditioner to your home or Building Management System.











#### 5 Years compressor warranty.





We guarantee the outdoor unit compressors in the entire range for five years.

# Accessories and control

## Connectivity

 <p><b>Wi-Fi adapter for smart control via Panasonic Comfort Cloud App.</b></p> <p>----- CZ-TACG1</p>	 <p><b>Interface adapter for integration into S-Link, plus external input and alarm/status output.</b></p> <p>----- CZ-CAPRA1</p>	 <p><b>KNX interface. Can be used with all models which have a CN-CNT connector (Intesis).</b></p> <p>----- PAW-AC-KNX-1i</p>
 <p><b>Modbus interface. Can be used with all models which have a CN-CNT connector (Intesis).</b></p> <p>----- PAW-AC-MBS-1</p>	 <p><b>BACnet interface. Can be used with all models which have a CN-CNT connector (Intesis).</b></p> <p>----- PAW-AC-BAC-1</p>	 <p><b>KNX interface. Can be used with all models which have a CN-CNT connector (Airzone).</b></p> <p>----- PAW-AZAC-KNX-1</p>
 <p><b>Modbus interface. Can be used with all models which have a CN-CNT connector (Airzone).</b></p> <p>----- PAW-AZAC-MBS-1</p>	 <p><b>BACnet interface. Can be used with all models which have a CN-CNT connector (Airzone).</b></p> <p>----- PAW-AZAC-BAC-1</p>	 <p><b>This interface can be used with all models which have a CN-RMT connector.</b></p> <p>----- PAW-AC-DIO</p>

## Individual controls

 <p><b>Wired remote controller for wall-mounted and floor console.</b></p> <p>----- CZ-RD517C</p>	 <p><b>Infrared remote controller Sky Remote. 2 m cable length of infrared receiver for hide-away.</b></p> <p>----- CZ-RL511D</p>	 <p><b>CONEX wired remote controller (non-wireless) for 4 way 60x60 cassette - PY3, white.</b></p> <p>----- CZ-RTC6W</p>	 <p><b>CONEX wired remote controller (non-wireless) for 4 way 60x60 cassette - PY3, black.</b></p> <p>----- CZ-RTC6</p>
--	--	--	--

## Panel

 <p><b>Panel for 4 way 60x60 cassette - PY3.</b></p> <p>----- CZ-KPY4</p>
--

## Pipe reducer

 <p><b>Reduces the connection size on the indoor unit from 1/2" to 3/8".</b></p> <p>----- CZ-MA1PA</p>	 <p><b>Increases the connection size on the outdoor unit from 3/8" to 1/2".</b></p> <p>----- CZ-MA2PA</p>	 <p><b>Reduces the connection size on the indoor unit from 5/8" to 1/2".</b></p> <p>----- CZ-MA3PA</p>
--	--	--



## RAC Solo accessories



**Kit of external aluminium grids with fixed fins (162 mm holes).**

-----  
PCZ-GB0738

**Kit of external aluminium grids with fixed fins (202 mm holes).**

-----  
PCZ-GB1091

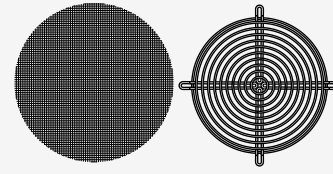

**Insect protection kit (1 metal mesh, 1 grid in metal wire and fixing accessories).**

-----  
PCZ-GB0755



**Side exit formwork for corner installation (right-hand outlet).**

-----  
PCZ-L00773

**Side exit formwork for corner installation (left-hand outlet).**

-----  
PCZ-L00774

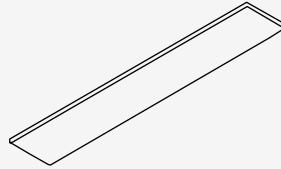

**Bottom cover kit for overhead installation for P-MOZ20/25/30IC5-E.**

-----  
PCZ-GB0737

**Bottom cover kit for overhead installation for P-MOG16IC5-E.**

-----  
PCZ-GB1105

**Condensate drain pipe heater kit\*.**

-----  
PCZ-GB1119

\* Check availability.

## Panasonic Commercial air to air

Panasonic has developed an impressive range of highly efficient Commercial Air Conditioners. This range confirms our commitment to the environment, with our highly efficient Inverter compressor technology to optimise performance.

*PACi*







Highlighted features	→ 202
Product quality and safety	→ 204
PACi NX Series	→ 206
PACi NX Series 4	→ 208
CONEX. Devices and apps	→ 210
Commercial Wi-Fi Adaptor	→ 211
Bringing nature's balance indoors	→ 212
PACi NX 4 way 90x90 cassette - PU3	→ 214
PACi NX adaptive ducted unit - PF3	→ 216
BION air pollutant filter	→ 218
PACi NX wall-mounted, 4 way 60x60 cassette and ceiling	→ 220
High static pressure hide-away 20,0-25,0 kW - PE4	→ 222
Jet Air Stream	→ 224
Solutions for server rooms applications	→ 226

<b>Commercial units range</b>	→ 228
Wall-mounted Professional Inverter -25 °C	→ 230
Elite - Standard wall-mounted · R32	→ 232
Elite - Standard 4 way 60x60 cassette · R32	→ 236
Elite - Standard 4 way 90x90 cassette · R32	→ 238
Elite - Standard ceiling · R32	→ 242
Elite - Standard adaptive ducted unit · R32	→ 246
Big PACi NX high static pressure hide-away · R32	→ 250
Jet Air Stream · R32	→ 251

<b>Commercial PACi NX Multi</b>	→ 252
Commercial twin, triple and double-twin systems · R32	→ 254

<b>Hydronic PACi NX</b>	
Panasonic PACi NX with Water Heat Exchanger	→ 258

<b>Ventilation</b>	
AHU connection kit PAH3M-1 for PACi NX	→ 262
Electric air curtain	→ 263
Air curtain with DX coil, connected to PACi NX	→ 264
Ceiling mounted air-e nanoe X Generator	→ 265
R22 Renewal. Fast, easy to install and cost effective	→ 266
Accessories and control	→ 270
Eurovent certified technical data	→ 276

## Highlighted features

PACi NX: Commercial air to air. The compact and high efficiency solution for shops, restaurants, offices or residential applications.



## Great savings and improved comfort. Panasonic has developed an impressive range of highly efficient Commercial air conditioners, with our highly efficient Inverter compressor technology to optimise performance.

A wide range for industry, office or residential application. With configuration from 1:1 to 4:1, Panasonic can offer the most comfortable climate with solutions designed for every environment.

The diverse array of connectivity and control systems allows you to manage your units whether locally or remotely. Receive real-time status updates and maintenance alerts, while optimising costs and energy usage.

### Energy saving

R32

REFRIGERANT

#### Refrigerant R32.

Our heat pumps containing R32 refrigerant show a drastic reduction in the value of Global Warming Potential (GWP).

A+++

9,6 SEER

#### Exceptional seasonal cooling efficiency based on the ErP regulation.

Higher SEER ratings mean greater efficiency and year-round cooling savings!

A+++

5,1 SCOP

#### Exceptional seasonal heating efficiency based on the ErP regulation.

Higher SCOP ratings mean greater efficiency and year-round heating savings!

28%

ECONAVI

#### Econavi.

Intelligent human activity sensor and sunlight sensor technologies that can detect and reduces the waste of energy by optimising air conditioner operation according to room conditions. With just one touch of a button, you can save energy.

INVERTER+

#### Inverter Plus system.

Inverter Plus system classification highlights Panasonic's highest performing systems.

INVERTER

#### Inverter.

The Inverter range provides greater efficiency and comfort. Provides more precise temperature control, without highs and lows, and keeps the ambient temperature constant with lower energy consumption and a significant reduction in noise and vibration levels.

HIGH EFFICIENCY COMPRESSOR

#### High efficiency compressor.

Panasonic Big PACi NX has compressors that operate with a wider Hz range realize a more efficient operation throughout the year.

R2 ROTARY COMPRESSOR

#### Panasonic R2 rotary compressor.

Designed to withstand extreme conditions, it delivers high performance and efficiency.

A+++

ErP 35°C

#### Better efficiency and value for low temperature applications.

On an energy efficiency scale from D to A+++ the PACi NX Water Heat Exchanger provide A+++ rated heating.

### High performance and indoor air quality

-20 °C

COOLING MODE

#### Down to -20 °C in cooling mode.

The air conditioner works in cooling mode when the outdoor temperature of -20 °C.

-20 °C

HEATING MODE

#### Down to -20 °C in heating mode.

The air conditioner works in heat pump mode when the outdoor temperature is as low as -20 °C.

nanoe™ X

nanoe™ X

#### nanoe™ X.

Technology with the benefits of hydroxyl radicals has the capacity to inhibit pollutants, viruses, and bacteria to clean and deodorise.

Super Quiet.

22 dB(A)

#### Super Quiet.

With Super Quiet technology our devices are quieter than a library (30 dB(A)).

DC fan

DC FAN

#### DC fan.

Safe and precise.

FILTER INCLUDED

FILTER INCLUDED

#### Filter included.

Hide-away with filter included.

BLUEFIN

BLUEFIN

#### Bluefin.

Panasonic Big PACi NX has extended the life of its condensers with an original anti-rust coating.

LARGE FAN

LARGE FAN

#### Large fan.

Panasonic Big PACi NX large fan provides larger air flow rate and very quiet operation at low speed.

AEROWINGS

AEROWINGS

#### More comfort with Aerowings.

Panasonic's Aerowings feature incorporates two blades that concentrate the air flow to cool or heat in the shortest possible time by distributing the air evenly throughout the room. For wall-mounted YKEA.

46 °C

COOLING MODE

#### Up to 46 °C in cooling mode.

PACi NX with Water Heat Exchanger system works in cooling mode at outdoor temperature up to 46 °C.

R22 / R410A / R32

R22 / R410A / R32

RENEWAL

#### R410A/R22 renewal.

The Panasonic renewal system allows good quality existing R410A or R22 pipe work to be re-used whilst installing high efficiency R32 systems.

5 YEARS COMPRESSOR WARRANTY

5 YEARS COMPRESSOR WARRANTY

#### 5 Years compressor warranty.

We guarantee the outdoor unit compressors in the entire range for five years.

### High connectivity

Panasonic AC Smart Cloud

PANASONIC AC SMART CLOUD

#### Panasonic AC Smart Cloud.

The AC Smart Cloud from Panasonic allows you to have complete control of all your installations. In a simple click, receive status updates from all your units in real-time, preventing breakdowns and optimising costs.

INTERNET CONTROL

INTERNET CONTROL

#### Internet control.

A next generation system providing user-friendly control of air conditioning or heat pump units from everywhere, using a simple Android™ or iOS smartphone or tablet via Wi-Fi.

BMS CONNECTIVITY

BMS CONNECTIVITY

#### BMS connectivity.

The communication port can be integrated into the indoor unit and provides easy connection to, and control of, your Panasonic air conditioner to your home or Building Management System.

INTEGRATION TO S-LINK

INTEGRATION TO S-LINK

#### Domestic integration to S-Link - CZ-CAPRA1.

Can connect RAC range to S-Link. Full control is now possible.

ADVANCED CONTROL

ADVANCED CONTROL

#### Advanced control.

A touch screen remote controller is included as a standard. Clean design, easy operation and quick access to all menus.

## Product quality and safety

All Panasonic air conditioners undergo strict quality and safety tests before sale. This rigorous process includes obtaining all necessary safety approvals, to ensure that all air conditioners we sell are not only built to the highest market standards, but are also completely safe.

R32  
REFRIGERANT



## Professional air conditioners with R32 refrigerant.

# R32

GWP REDUCED BY

# 75%

Panasonic recommends R32, with lower Global Warming Potential (GWP). Compared to R22 and R410A, R32 has a low potential impact on global warming. Panasonic takes action in helping to protect the environment. In line with the European countries participating in the Montreal Protocol, protecting the ozone layer and preventing global warming, Panasonic is leading the switch to R32.

### Installation innovation.

- Extremely easy to install, practically the same as R410A
- Single substance refrigerant, which makes it easier to recycle and reuse

### Environmental innovation.

- Zero impact on the ozone layer
- 75% less impact on global warming

### Economic and energy consumption innovation.

- Lower cost and greater savings
- Higher energy efficiency than R410A

## PACi NX Elite: Top-tier commercial air conditioning.

### The PACi NX Elite range has been expanded to include the Big PACi NX models 20,0-25,0 kW.

Outstanding performance at extreme ambient temperatures with very high energy efficiency both in heating and cooling. Fans, fan motors, compressors and heat exchangers engineered for maximum savings result in higher seasonal efficiencies, which ranks as one of the best in the industry, ensuring reduced CO<sub>2</sub> emissions, energy consumption and operating costs.

### From 3,6 to 25,0 kW.

- Meeting all necessary approvals to ensure quality and safety
- Top class SEER: 8,9 A+++ / SCOP: 5,1 A+++ at 3,6 kW (in 90x90 cassette)
- A compact outdoor unit featuring a single fan across all the capacities
- Long piping allowance, maximum 100 m <sup>1)</sup>
- Wide operation range, up to 52 °C in cooling and down to -20 °C in heating
- Auto restart after power outage
- Twin, triple and double-twin connections
- Water Heat Exchanger <sup>2)</sup> and AHU connection compatibility

1) For models 10,0 - 25,0 kW. 2) For models 20,0 - 20,5 kW.



## PACi NX Standard: For economy and value.

With high quality design and engineering, the PACi NX Standard are the perfect solutions for projects which demand quality on a limited budget. In addition, compact and lightweight design makes them ideal for installations with limited space including small commercial and residential applications. The slim and lightweight outdoor unit design enables installation even in very challenging locations.

### From 2,5 to 14,0 kW.

- Extended range of outdoor units starting from 2,5 kW
- Great balance of system cost and performance
- Top class SEER / SCOP in the standard Inverter category  
SEER: 8,1 A++ / SCOP: 4,8 A++ at 3,6 kW (in 90x90 cassette)
- Variety of individual and central controllers which provides full flexibility
- Compact outdoor units, small footprint and lightweight
- Twin connection possible from 10,0 to 14,0 kW
- Operation range, up to 43 °C in cooling and down to -15 °C in heating



## PACi NX Series. The next generation is here

NX Series with R32 refrigerant has been developed to meet the demand of easy refurbishment with 3 wire method.

Integrated with IoT solutions and includes nanoe™ X function as standard.



### 1 PACi NX Series for absolute ease of refurbishment

This series have been developed with 3 wire power and communication. It makes it simple and easy to replace old systems with 3 wire connections, which is prevalent in many systems.

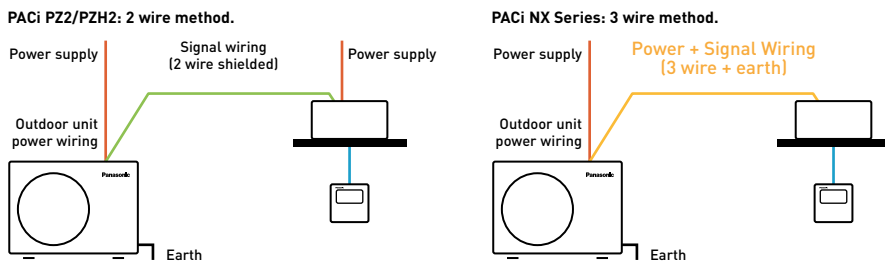

### 2 CONEX with IoT integration

The wired remote controller series is fully integrated with IoT solutions developed by Panasonic. Detailed operation, maintenance setting and service operation are all possible with smartphone or tablet.

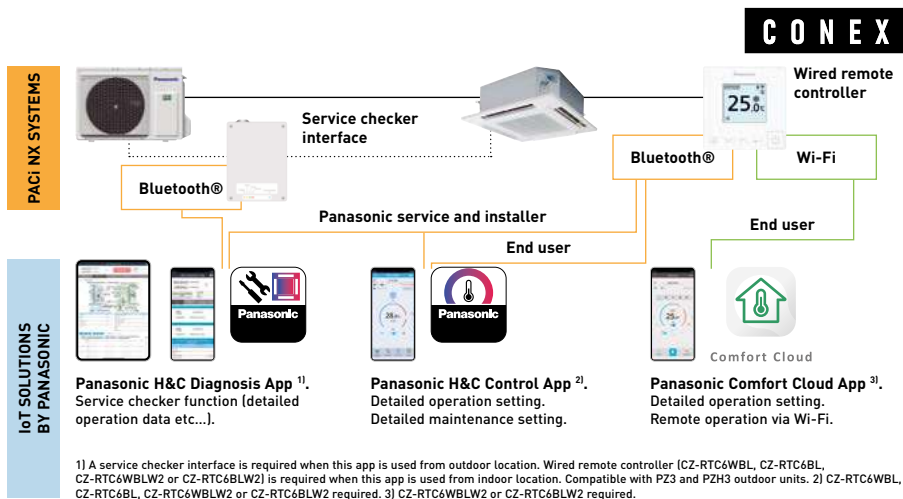

### 3 Let Panasonic take care of indoor air quality

Thanks to the nanoe™ X properties, several types of pollutants can be inhibited such as certain types of bacteria, viruses, mould, allergens, pollen and certain hazardous substances. This unique technology is equipped to provide better air quality whether residential or commercial.



#### 7 effects of nanoe™ X - Panasonic unique technology.

Deodorises	Capacity to inhibit 5 types of pollutants						Moisturises
Odours	Bacteria and viruses	Mould	Allergens	Pollen	Hazardous substances	Skin and hair	

The nanoe™ X performance varies depending on the room size, environment and usage and it may take several hours to reach the full effect. nanoe™ X is not medical device, local regulations on building design and sanitary recommendations must be followed.

+ REFER TO PAGE 14 FOR MORE DETAILS AND VALIDATION DATA

### 4 Increasing the efficiency

The PACi NX Series have improved seasonal efficiencies in both heating and cooling versus the previous generation.

Energy class <sup>1)</sup> and seasonal efficiency value ( $\eta_{s,c} / \eta_{s,h}$ ) <sup>2)</sup>														
kW	Wall-mounted - PK4		4 way cassette - PY3		4 way cassette - PU3		Ceiling - PT3		Adaptive ducted - PF3		Hide-away - PE4			
	Elite	Standard	Elite	Standard	Elite	Standard	Elite	Standard	Elite	Standard	Elite			
2,5		A++ A+		A++ A++										
3,6	A++ A++ A++ A+		A++ A++ A++ A+		A+++ A+++ A++ A++		A++ A++ A++ A+		A++ A+ A+ A+					
5,0	A++ A++ A++ A+		A++ A++ A++ A+		A+++ A+++ A++ A++		A++ A++ A++ A+		A++ A+ A+ A+					
6,0	A++ A++ A++ A++		A++ A+ A++ A+		A++ A++ A++ A++		A++ A++ A++ A++		A++ A+ A++ A+					
7,1	A++ A++ A+ A+				A++ A++ A++ A++		A++ A++ A+ A+		A++ A++ A+ A+					
10,0	A++ A+ A++ A+				A++ A++ A++ A+		A++ A+ A++ A+		A++ A+ A++ A+					
12,5					304,3% 186,0% 267,0% 157,0%		278,4% 175,6% 241,7% 147,4%		281,7% 165,0% 257,4% 142,6%					
14,0					286,6% 181,2% 257,0% 152,2%		263,3% 169,3% 228,8% 145,3%		275,9% 162,6% 252,2% 140,6%					
20,0													237,8%	146,0%
25,0													213,0%	145,0%

1) Energy label scale from A+++ to D for models below 12,0 kW (EU regulation 626/2011). 2)  $\eta_{s,c} / \eta_{s,h}$  values for models above 12,0 kW (EN 14825).

# PACi NX Elite Series 4





The compact chassis newly designed with one fan up to 25,0 kW, will fit in limited installation space.

- A compact outdoor unit featuring a single fan across all the capacities up to 25,0 kW
- With the unit weighting only 66 kg\*, it is easy to carry and easy to install

\* For model 7,1 kW.



PACi NX Elite from 7,1 to 14,0 kW

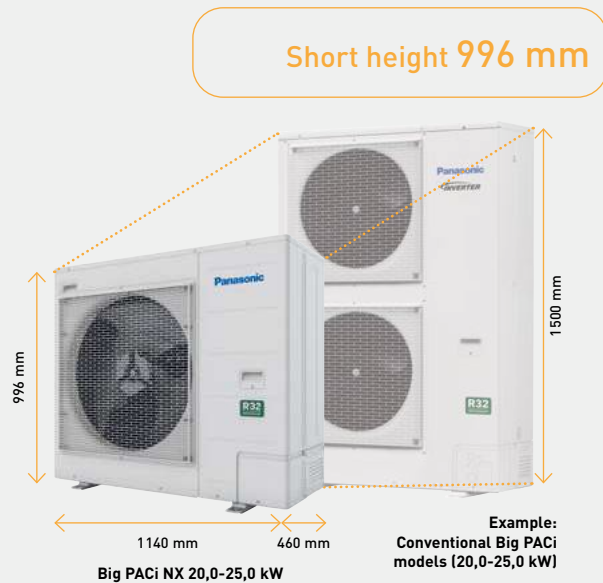

Highly efficient performance in a compact body

One fan outdoor units keep the excellent seasonal performance by optimizing the layers of the heat exchanger. As a result, PZH4 Series provide the equivalent high seasonal performance to conventional 2 fan models.

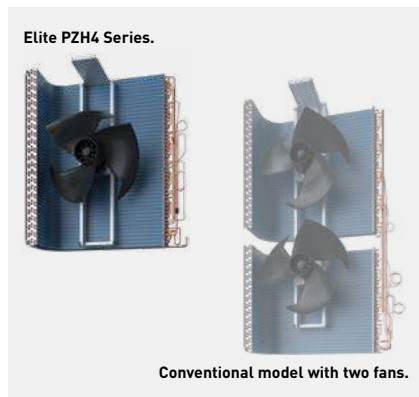

PZH4 Series seasonal performance.

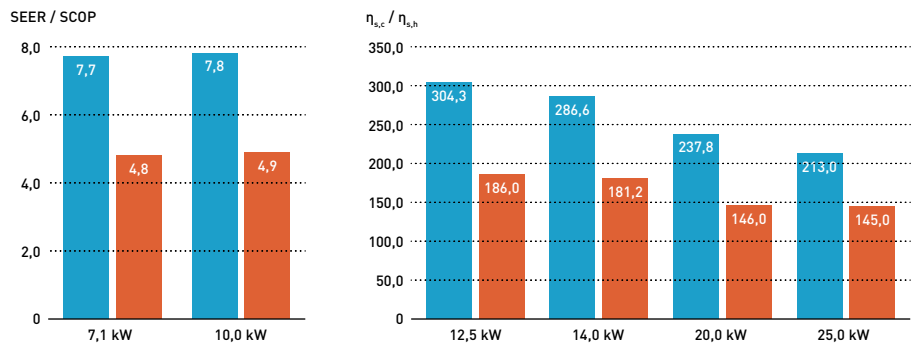

\* Performance tested with a 4 way 90x90 cassette for 7,1 to 14,0 kW and a high static pressure hide-away 20,0-25,0 kW.

Extended operation range up to 52 °C in cooling and down to -20 °C in heating

Upgraded PACi NX Elite Series are capable of working even in the challenging ambient conditions. Cooling operation is possible when outdoor temperature is as low as -20 °C\* or as high as 52 °C. Heating operation can also be utilized at outdoor temperatures down to -20 °C when outdoor temperature is as low as -20 °C.

\* For models 10,0 – 14,0 kW with pipe length up to 30 m.

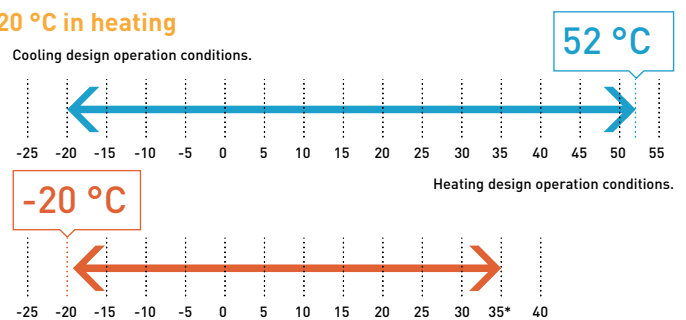

\* For models 20,0 – 25,0 kW.

Long piping allowance maximum 100 m\*

Increased piping length gives great design flexibility to adapt various building types and sizes. Piping length: 100 m (10,0 to 25,0 kW), 60 m (7,1 kW)

\* For models 10,0 – 25,0 kW.

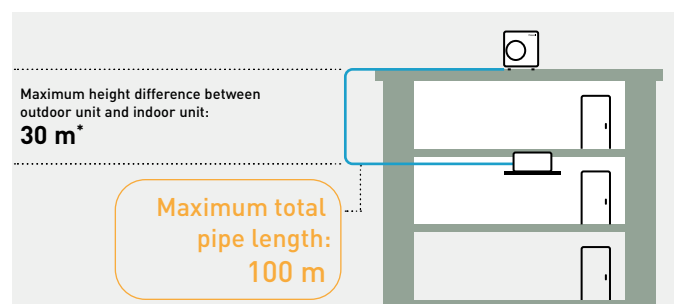

\* 15 m if the outdoor unit is below the indoor unit.

# CONEX. Devices and apps

CONEX provides comfort and control for varying user needs. Accessible, flexible and scalable with different controllers and apps. Perfectly meeting requirements of modern controls for end user, installer and service.



- 1 Intuitive control with stylish design**
- Simple operation at a glance
  - Clean face with full flat and LCD display
  - Compact body, only 86x86 mm

- 2 Control comfort with your smartphone**
- Flexible control options with IoT integration
  - Panasonic H&C Control App for daily remote control operation
  - Panasonic Comfort Cloud App for remote operation 24/7/365

- 3 Easy maintenance with service support app**
- Quick and easy app set-up for system setting
  - Panasonic H&C Diagnosis App enables the user to obtain detailed system operation data
- \* The use of apps depends on the remote controller model.

## CONEX with IoT integration



The wired remote controller series is fully integrated with IoT solutions developed by Panasonic. Detailed operation, maintenance setting and service operation are all possible with smartphone or tablet.

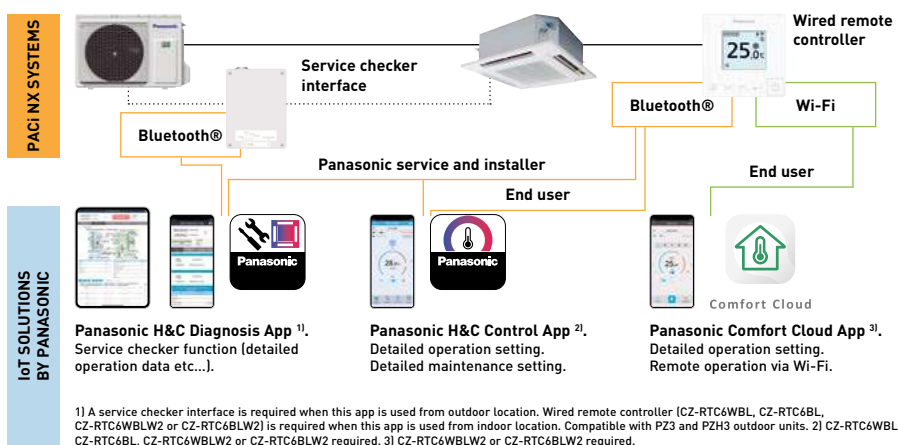

White model	CZ-RTC6W	CZ-RTC6WBL	CZ-RTC6WBLW2
Black model	CZ-RTC6	CZ-RTC6BL	CZ-RTC6BLW2
Wired connection compatible with	PACi NX, ECOi, GHP	PACi NX, ECOi, GHP	PACi NX only
Wireless functions	No wireless capability	Bluetooth®	Bluetooth® + Wi-Fi
<b>App compatibility</b>			
Panasonic Comfort Cloud App	—	—	✓
Panasonic H&C Control App	—	✓ PACi NX, ECOi, GHP	✓ PACi NX only
Panasonic H&C Diagnosis App <sup>1)</sup>	—	✓ PACi NX only <sup>2)</sup>	✓ PACi NX only <sup>2)</sup>
Outdoor unit settings (remote controller connected to indoor unit)	✓ PACi NX only <sup>2)</sup>	✓ PACi NX only <sup>2)</sup>	✓ PACi NX only <sup>2)</sup>

1) Compatible with U-71/100/125/140PZH3E5/8 and U-100/125/140PZ3E5/8. 2) When connected to PACi NX indoor and outdoor unit combination.

# Commercial Wi-Fi Adaptor

Panasonic CZ-CAPWFC2 interface adaptor, allows connection of one or a group of indoor units to Panasonic Comfort Cloud App, which provides control, monitoring, scheduling, and error alerts.

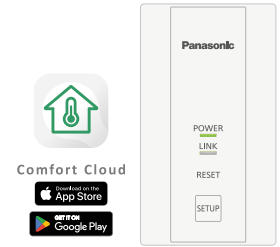

### Advanced smartphone control

Control PACi NX, ECOi, and ECO G indoor units with your smartphone whenever and wherever you are, by using Panasonic Comfort Cloud App and Commercial Wi-Fi Adaptor. This scalable solution is ideal for one system, one site or multiple locations. Coupling the adapter with the already feature rich systems, makes it an ideal solution for residential and commercial applications.

**1 From 1 to 200 units**  
User can control up to 10 different sites, with up to 20 units / groups per site. Additionally, one adaptor can be connected to 1 indoor or to a group of up to 8 indoors.

**2 Voice control compatible**  
Registering the unit to Panasonic Comfort Cloud App makes it compatible with the most popular voice assistants.

**3 Multi user**  
The Panasonic Comfort Cloud App allows multi-user access control, whilst allowing user restriction to specific units.

**4 Easy scheduling**  
Complex weekly scheduling made simple. Not only for one unit, but across multiple sites, and from a smartphone.

**5 Energy monitor**  
See the estimated power consumption and compare with other periods, to see how energy consumption can be further reduced. Check list of units that provides consumption\*.

**6 Error codes**  
Error code notification through the App, provides early notification and allows for faster repair.

\* Function available depending on the model.

### Connection diagram

Commercial Wi-Fi Adaptor wiring length is 1,9 m and connects to indoor unit via T10 connector and R1/R2 terminal connectors.

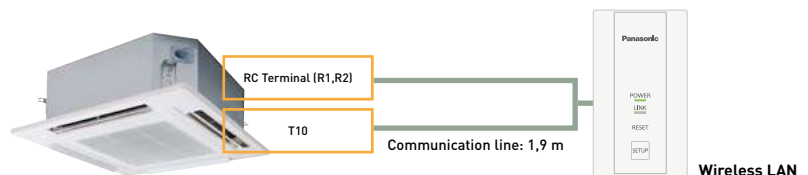

### Download free app: Panasonic Comfort Cloud App.

Other hardware requirements: Router and Internet (purchase and subscribe separately). Panasonic Cloud Server is designed, operated and managed by Panasonic.

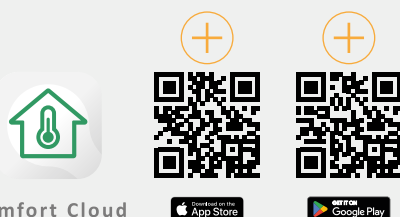

Input Voltage	12 V DC (supplied from T10 connector)
Power Consumption	Maximum 2,4 W
Size (HxWxD)	120 x 70 x 25 mm
Weight	190 g (including communications lines)
Interface	1 x Wireless LAN
Wireless LAN Standard	IEEE 802,11 b/g/n
Frequency Range	2,4 GHz band
Operating range	0 ~ 55 °C, 20 ~ 80 RH%
Connectable indoor unit	1 unit
Length of communication line	1,9 m (included)

# Bringing nature's balance indoors



## nanoe™ X, technology with the benefits of hydroxyl radicals.

Abundant in nature, hydroxyl radicals (also known as OH radicals) have the capacity to inhibit pollutants, viruses, and bacteria to clean and deodorise. nanoe™ X technology can bring these incredible benefits indoors so that hard surfaces, soft furnishings, and the indoor environment can be a cleaner and more pleasant place to be, whether at home, work, or visiting hotels, shops and restaurants etc.



### What is unique about nanoe™ X?

**Effective on fabrics and surfaces.**

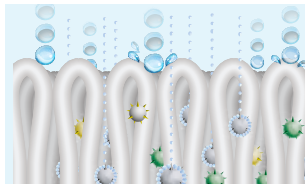

1 | At one billionth of a metre, nanoe™ X is much smaller than steam and can deeply penetrate cloth fabrics to deodorise.

**Longer lifespan.**



2 | Contained in tiny water particles, nanoe™ X has a long lifespan, which is about 600 seconds, to spread easily around the room.

**Huge quantity.**



3 | nanoe X Generator Mark 3 produces 48 trillion hydroxyl radicals per second. Greater amounts of hydroxyl radicals contained in nanoe™ X lead to higher performance on inhibition of pollutants.

**Maintenance-free.**



The image shows nanoe X Generator Mark 3.

4 | No service and maintenance required. nanoe™ X is a filter free solution that does not require maintenance, as its atomisation electrode is enveloped with water during its generation process and it is made with Titanium.

### 7 effects of nanoe™ X - Panasonic unique technology

**Deodorises**

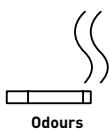

Odours

**Capacity to inhibit 5 types of pollutants**

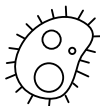

Bacteria and viruses



Mould



Allergens



Pollen



Hazardous substances



Skin and hair

\* Refer to <https://aircon.panasonic.eu> for more details and validation data.

### First nanoe™ device was developed by Panasonic in 2003

**Generator: nanoe™**

2003

480 billion hydroxyl radicals/sec

**Ion particle structure**

Hydroxyl radicals

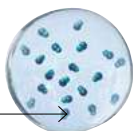

**Generator: nanoe™ X**

**Mark 1 - 2016**

4,8 trillion hydroxyl radicals/sec

10x times

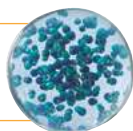

**Mark 2 - 2019**

9,6 trillion hydroxyl radicals/sec

20x times

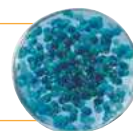

**Mark 3 - 2022**

48 trillion hydroxyl radicals/sec

100x times

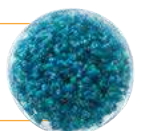

**nanoe™ X, internationally-validated technology in testing facilities.**

The effectiveness of nanoe™ X technology has been tested by 3rd party laboratories in Germany, France, Denmark, Japan and China.

The nanoe™ X performance varies depending on the room size, environment and usage and it may take several hours to reach the full effect. nanoe™ X is not medical device, local regulations on building design and sanitary recommendations must be followed. Test results conducted under controlled laboratory conditions. Performance of nanoe™ X might differ in real life environment.

	Tested contents	Generator	Result	Capacity	Time	Testing organisation	Report No.	
Airborne	Virus	Influenza (H1N1)	Mark 2	98,3% inhibited	30 m³	1,5 h	China Electronic Product Reliability and Environmental Testing Research Institute	J2003WT8888-00889
		Bacteriophage ΦX174	Mark 1	99,2% inhibited	Approx. 25 m³	6 h	Kitasato Research Center for Environmental Science	24_0300_1
	Bacteria	Staphylococcus aureus	Mark 1	99,7% inhibited	Approx. 25 m³	4 h	Kitasato Research Center for Environmental Science	24_0301_1
Adhering	Virus	SARS-CoV-2	Mark 1	91,4% inhibited	6,7 m³	8 h	Texcell (France)	1140-01 C3
		SARS-CoV-2	Mark 1	99,9% inhibited	45 L	2 h	Texcell (France)	1140-01 A1
		Bacteriophage ΦX174	Mark 1	99,8% inhibited	Approx. 25 m³	8 h	Japan Food Research Laboratories	13001265005-01
		Xenotropic murine leukemia virus	Mark 1	99,999% inhibited	45 L	6 h	Charles River Biopharmaceutical Services GmbH	—
		Coxsackie virus (CA16)	Mark 2	99,9%inhibited	30 m³	4 h	China Electronic Product Reliability and Environmental Testing Research Institute	J2002WT8888-00439
		Bacteriophage	Mark 3	98,81% inhibited	Approx. 139,3 m³	4 h	SGS Inc	SHES210901902584
	Bacteria	MS2 Phage Virus	Mark 3	99,99% inhibited	Approx. 25 m³	2 h	Shokukanen, Inc.	227131N
		Staphylococcus aureus	Mark 1	99,9% inhibited	20 m³	8 h	Danish Technological Institute	868988
	Pollen	Cedar pollen	Mark 3	99%inhibited	Approx. 24 m³	12 h	Panasonic Product Analysis Center	H21YA017-1
		Ambrosia pollen	Mark 1	99,4% inhibited	20 m³	8 h	Danish Technological Institute	868988
	Odours	Cigarette smoke odour	Mark 1	Odour intensity reduced by 2,4 levels	Approx. 23 m³	0,2 h	Panasonic Product Analysis Center	4AA33-160615-N04
			Mark 3	Odour intensity reduced 1,7 levels	Approx. 139,3 m³	0,5 h	SGS Inc	SHES210901902478

**Licensed in VDI 6022**

Certification of a HVAC system under VDI 6022 guarantees that the system fulfills the market's strictest hygiene requirements.



**VDI 6022 - Part 5 <sup>1)</sup> Certification.**  
**Avoidance of allergenic exposure.**  
 Inhibits a wide range of harmful bacteria, viruses, mould, pollen and allergens.



**VDI 6022 - Part 1 <sup>1)</sup> & 1.1 <sup>2)</sup> Certification.**  
**Ventilation and indoor-air quality.**  
 Panasonic nanoe™ X technology improving indoor air quality.

1) Certification mark only valid for nanoe X Generator Mark 3. 2) Certification mark only valid for nanoe X Generator Mark 2 and Mark 3.

**nanoe™ X: improving protection 24/7.**

Acts to clean your air, so that the indoor environment can be a cleaner and more pleasant place to be all day long. nanoe™ X works together with heating or cooling function when you are at home and can work independently when you are away. Give the air conditioning the strength to increase the protection at home with nanoe™ X technology and convenient control via the Panasonic Comfort Cloud App.

**Cleans the air when you are away.**  
 Leave the nanoe™ mode ON to inhibit certain pollutants and deodorise before you return home.

**Improves your environment when you are at home.**  
 Enjoy a cleaner, comfortable space with loved ones.

**Panasonic Heating & Cooling Solutions is incorporating nanoe™ technology in a wide range of equipment**

- 

**Wall-mounted.**  
Built-in nanoe X Generator Mark 3.



**Ceiling.**  
Built-in nanoe X Generator Mark 2.
- 

**4 Way 60x60 cassette.**  
Built-in nanoe X Generator Mark 2.



**Adaptive ducted unit.**  
Built-in nanoe X Generator Mark 2.
- 

**4 Way 90x90 cassette.**  
Built-in nanoe X Generator Mark 1.



**High static pressure hide-away.**  
Built-in nanoe X Generator Mark 3.
- 

**Ceiling mounted air-e nanoe X Generator.**  
Built-in nanoe X Generator Mark 1.

## PACi NX 4 way 90x90 cassette - PU3

These cassettes offer upgraded nanoe™ X and Econavi technologies to make the room air more comfortable and healthy and to increase the energy efficiency.



### 1 Improved indoor air quality with nanoe™ X and fresh air intake

- nanoe™ X technology equipped as standard for improved indoor air quality
- Internal cleaning function for the unit with nanoe™ X
- High external fresh air intake volume with optional kit (CZ-FDU3 + CZ-ATU2)

### 2 Superior energy efficiency and comfort

- High seasonal efficiency both in heating and cooling, maximum SEER: 8,9 A+++ / SCOP: 5,1 A+++\*
- Econavi: Intelligent sensors to increase energy savings and comfort
- Super Quiet operation down to 27 dB(A)

\* For 3,6 kW model.

### 3 Easy installation

- Light weight, easy piping and integrated drain pump for quick installation
- Wired remote controller CZ-RTC6WBL and CZ-RTC6BL allows easy system setting via Bluetooth®



White and graphite black panels available, offering versatile options for commercial applications.

+ SEE PRODUCT SPECIFICATIONS



Standard panel, white (RAL9003).  
CZ-KPU3



Standard panel, graphite black (RAL9011).  
CZ-KPU3B

Econavi panel, white (RAL9003).  
CZ-KPU3A

Always fresh and clean air with nanoe™ X

The 4 way 90x90 cassette with nanoe™ X, when tested, has shown to inhibit hazardous substances by 92%, when compared to natural reduction\*. In addition to the 7 effects of nanoe™ X, the indoor unit can also be cleaned with a short operation of nanoe™ X + dry mode.

\* Controllers (CZ-RTC5B, CZ-RTC6W/BL/BLW2 or CZ-RTC6/BL/BLW2) are required.

After cooling/drying operation, the inside of the indoor unit is automatically dried and nanoe™ X is activated to suppress mould growth.

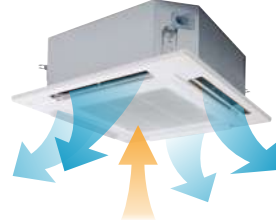

Operates the fan to discharge internal humidity.

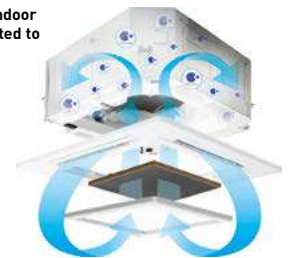

Operate the fan to circulate nanoe™ X internally.

nanoe™ X effect against odour proven in large space

92% of hexadecane <sup>1)</sup> is inhibited after 8-hours exposure in room side 267 m<sup>2</sup>.

Hexadecane inhabitation ratio [%].

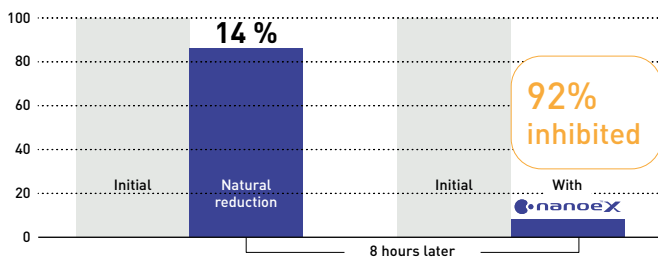

Test ambient.

3rd party certification organization SIRIM <sup>2)</sup> conducted the performance experiment of 4 way cassette equipped with nanoe X Generator Mark 1 device in inhibiting hexadecane, a chemical contaminant.

1) Hexadecane is a hazardous substance contained in gasoline and diesel exhaust gas, and considered to be one cause of oil odour. 2) SIRIM Berhad (SIRIM), a premier industrial research and technology organization in Malaysia, wholly-owned by the Ministry of Finance Incorporated.

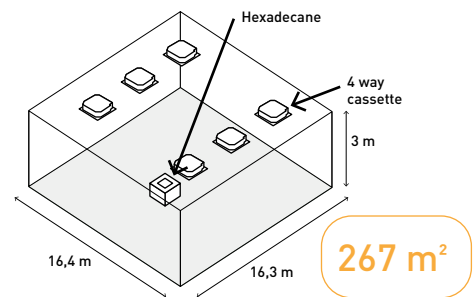

Optional Econavi intelligent sensor

Human activity sensor and floor temperature sensor can reduce waste energy, by optimising air conditioner operation.

Advanced Econavi functions.

2 sensors (movement and floor temperature) can provide a reduction in wasted energy by means of effective control. The floor temperature can be detected with a ceiling height of up to 5 m.

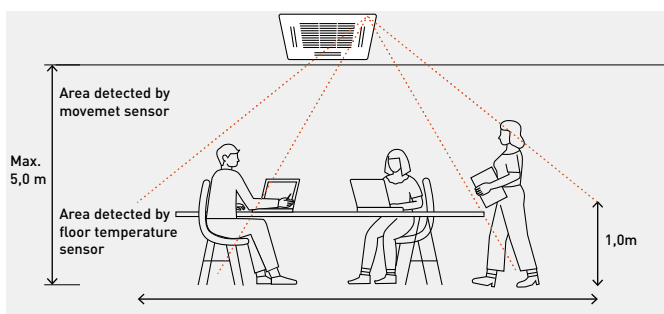

Econavi exclusive panel. Optional (CZ-KPU3A)



**Floor temperature sensor.**  
This sensor detects average floor temperature and operates circulation if floor temperature is low.

**Movement sensor.**  
This sensor detects the amount of human activity, and operates effectively.



Wired remote controller CZ-RTC5B, CZ-RTC6W/BL/BLW2 or CZ-RTC6/BL/BLW2 is required.

## PACi NX adaptive ducted unit - PF3

The adaptive ducted units provide better flexibility with both installation possibilities, horizontal and vertical. The powerful external static pressure, maximum 150 Pa.







+ SEE PRODUCT SPECIFICATIONS

**1 Highly flexible installation**  
2 installation possibilities (horizontal / vertical).

**2 High seasonal performance with slim body**  
Maximum SEER: 7,4 A++<sup>1)</sup> / SCOP: 4,7 A++<sup>2)</sup>.  
1) For 10,0 kW model. 2) For 7,1 kW model.

**2 installation possibilities (horizontal / vertical)**

Vertical installation is available. External static pressure 150 Pa, sufficient for remotely installing units away from the rooms.



**3 Comfort operation**  
· Super Quiet operation, minimum 22 dB(A)\*  
· Optimized IAQ solutions for different target objectives. nanoe™ X and the BION air pollutant filter (optional)  
\* 3,6 kW model and when operating with external static pressure 50 Pa in low fan mode.

**Improved drain pan design**

Just one drain pan for both horizontal and vertical installations. No need to modify the unit.

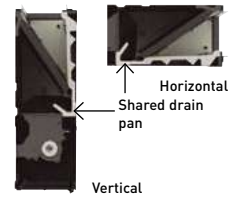

**Selectable inlet air position**

Inlet air position may be adjusted by means of a removable panel, to allow rear or bottom entry, depending on the duct installation.

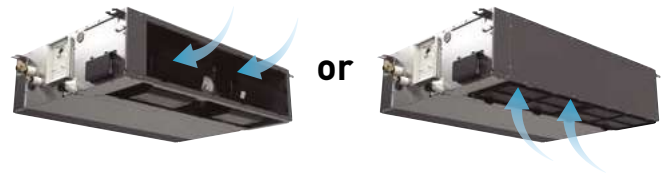

**Maximum efficiency**

Energy class <sup>1)</sup> and seasonal efficiency value ( $\eta_{s,c} / \eta_{s,h}$ ) <sup>2)</sup>		3,6	5,0	6,0	7,1	10,0	12,5	14,0
Elite		A++	A++	A++	A++	A++	281,7%	275,9%
		A+	A+	A++	A++	A+	170,0%	171,0%
Standard		A+	A++	A++	A++	A++	257,4%	252,2%
		A+	A+	A++	A+	A	142,6%	140,6%

1) Energy label scale from A+++ to D for models below 12,0 kW (EU regulation 626/2011). 2)  $\eta_{s,c} / \eta_{s,h}$  values for models above 12,0 kW (EN 14825).

**Compact body**

- Only 250 mm high
- Light units from 25 to 39 kg

Conventional model	Adaptive ducted
33 kg	30 kg
290 mm	250 mm



**Better indoor air quality with nanoe™ X**

The performance of nanoe™ X technology is maintained, even with 10 m long ducts\*. The effect of improved air quality is sufficient to allow for numerous duct shapes to fit the application.

\* Panasonic internal survey.

As the experiments demonstrate, up to a duct length of 10 m, effectiveness of nanoe™ X is maintained even if the duct is bended 3 times.

**nanoe™ X effect against odour proven in large space**

In a room of 139 m<sup>2</sup>, tobacco odour is reduced by a factor of 0,7 when compared to natural reduction over a period of 2 hours.

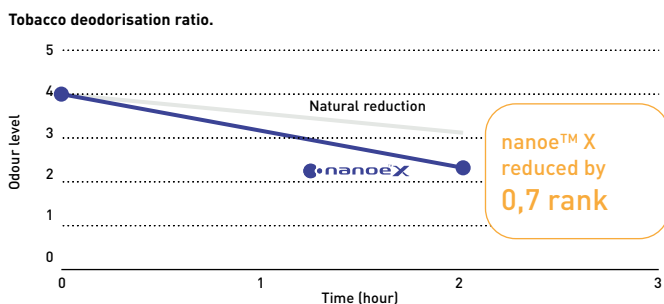

**Test ambient.**  
3rd party international testing institute KAKEN<sup>1)</sup> conducted the performance experiment of Adaptive ducted equipped with nanoe X Generator Mark 2 device removing tobacco odour.  
1) KAKEN TEST CENTER General Incorporated Foundation in Japan, international testing institute.

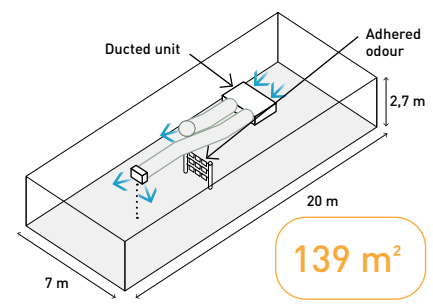

## BION air pollutant filter (optional)

Collaborating with BION, experts in filtration equipment, a new molecular filtration is available to improve indoor air quality.





The efficiency of nitrogen dioxide (NO<sub>2</sub>) removal can reach 99,5%\*

\* Measured by ASTM6646 international standards. Efficiency reaches 99,5% within 4,8 seconds of contact time with the media bed (FAM filter). \*\* The performance varies depending on the room size, environment and usage and it may take several hours to reach the full effect. BION air pollutant filter is not medical device, local regulations on building design must be followed. Test results conducted under controlled laboratory conditions. Performance of BION air pollutant filter might differ in real life environment.

**BION air pollutant filter traps and reduces certain types of harmful pollutant gases, listed below**

- Nitrogen oxides (NO<sub>x</sub>)
- Ozone (O<sub>3</sub>)
- Sulfur dioxide (SO<sub>2</sub>)
- Formaldehyde (HCHO)
- Volatile organic compounds (VOCs)

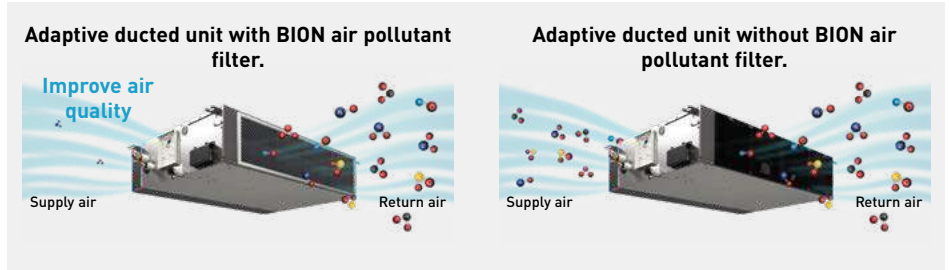

**The BION air pollutant filter is an ideal solution for improving indoor air quality in urban areas.**

**Air pollution in urban areas in Europe**

It is reported that in 2021, a significant portion of the Europe's urban population has been exposed to high levels of key air pollutants\*.

- 75% of the urban population was exposed to NO<sub>2</sub> concentrations above 10 µg/m<sup>3</sup>
- 94% were exposed to concentrations of O<sub>3</sub> above 60 µg/m<sup>3</sup>

\* The "Europe's Air Quality Status 2023" report (EEA, 2023) assesses levels of air pollutants measured in ambient air across Europe (> 2000 locations) for the years 2021 and 2022. It compares them against both EU standards as set out in the Ambient Air Quality Directives and the 2021 WHO Air Quality Guidelines.

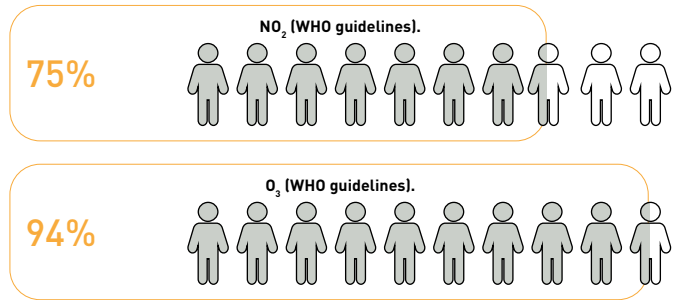

Share of the Europe's urban population exposed to air pollutant concentrations above EU standards and WHO guidelines in 2021, as referenced in the EEA 2023.

**Why outdoor air pollution matters to IAQ?**

Poor indoor air quality is associated with outdoor air pollutants such as car exhaust and factory fumes, and the two are closely linked. A significant portion of human exposure to air pollution occurs when they are indoors.



**Different objectives, different IAQ solutions**

In today's world, we are concerned about wellbeing and the air we breathe. And technology exists to ensure improved indoor air quality. With the introduction of the BION air pollutant filter, Panasonic offers IAQ solutions optimized for various target objectives.

IAQ Solution	nanoe™ X	BION air pollutant filter
<b>Objectives</b>	Inhibit particles such as pollutants, certain types of viruses, and bacteria to clean and deodorise	Inhibit gases such as nitrogen oxides (NO <sub>x</sub> ), ozone (O <sub>3</sub> ), sulfur dioxide (SO <sub>2</sub> ), formaldehyde (HCHO) and volatile organic compounds (VOCs)
<b>Technology</b>	Hydroxyl radicals contained in water	Molecular filtration
<b>Filtering mechanism</b>	Physical capture of particles	Adsorption and absorption
<b>Availability</b>	Built into all air-to-air indoor units as a standard	Optional accessory for the adaptive ducted unit (PF3/MF3)

<b>BION air pollutant filter*</b>	PAW-APF800F	PAW-APF1000F	PAW-APF1400F
<b>Compatible adaptive ducted unit</b>	S-3650PF3E	S-6071PF3E	S-1014PF3E

\* The filter cartridge and filter casing are included in the package.

# PACi NX wall-mounted, 4 way 60x60 cassette and ceiling



A new era of air conditioning solutions are here, with built-in nanoe™ X technology.



[+ SEE PRODUCT SPECIFICATIONS](#)

## PACi NX wall-mounted - PK4.

Equipped with the upgraded nanoe™ X (Generator Mark 3) for improved indoor air quality. It's modern, flat design with a stylish matte white finish complements any interior, while improved fan serviceability ensures effortless maintenance.

### Modern design for any interior

Its modern, flat design with a stylish matte white finish suits any interior, perfect for commercial projects.

Air distribution is automatically altered depending on the operational mode of the unit

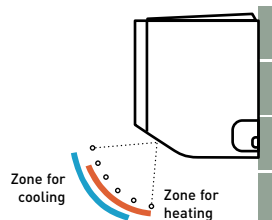

### Piping outlet in six directions

Piping outlet is possible in six directions of; right, right rear, right bottom, left, left rear and left bottom, making the installation work more flexible.



### Efficient installation with drain hose support holders and lock mechanism

**Easy connection and disconnection of the drain hose.** Locking mechanism between the drain tray and hose ensures a tight connection during installation and easy dismantling.



**Built-in support holders for secure spacing.** Holds the indoor unit against the wall, providing clear access for setting up the drain hose and piping.





[+ SEE PRODUCT SPECIFICATIONS](#)

## PACi NX 4 way 60x60 cassette - PY3.

The PY3 not only perfectly matches with 600 x 600 mm ceiling grids but also provides an additional benefit for better indoor quality, with nanoe™ X built-in.

### Industry-leading energy efficiency

- Energy class A++\* with Elite outdoor range
- Energy class A++ with Standard outdoor range 2,5 kW model

\* Except for 6,0 kW.

### Internal cleaning function

When cooling or dry operation stopped, internal drying and nanoe™ X circulation air flow is activated in order to suppress the mould proliferation inside the unit (air flow passage, fan, heat exchanger)\*.

\* Depending on the installation environment or operating hours, mould proliferation or inhabitation of mould growth will be changed.

### Compact and stylish design

- Required ceiling depth of only 250 mm
- Exposed area is only 30 mm

### Individual flap control

Better control of the air flow with 4 motors, providing individual flap control. Perfect air distribution without direct air flow, to reduce the feeling of cold drafts.

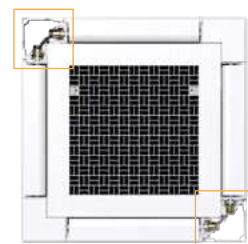

[+ SEE PRODUCT SPECIFICATIONS](#)

## PACi NX ceiling - PT3.

Providing outstanding energy-saving performance, comfort and long-distance air flow distribution, these units are perfect for retail stores and schools.

### Comfortable, long-distance air flow distribution

The shape of the outlet has been optimised to provide long-distance air flow distribution.

Even in long rooms, air flow reaches every corner for exceptionally comfortable air conditioning.

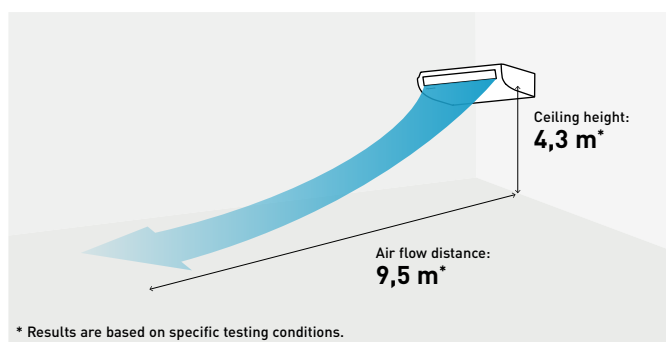

\* Results are based on specific testing conditions.

### Compact looking, stylish, one-motion design

With its streamlined, one-motion form, the unit looks thin and compact when installed for a neat appearance in any room. When not operating, the louver closes to provide an elegant look while also keeping the unit clean.

### Energy-saving technology delivering top-class efficiency

Optimisation of the shape of the casing and fan assures bigger air flow and higher efficiency. Energy-saving performance is top class in the industry. Thanks to new DC fan motor and large diagonal air flow fan.

## Big PACi NX high static pressure hide-away 20,0-25,0 kW - PE4

The split-able indoor unit design facilitates easy piping work. nanoe™ X technology equipped as standard for improved indoor air quality.





+ SEE PRODUCT SPECIFICATIONS

**1 Compact and light indoor body**  
Compact and light indoor body, keeping the high efficiency, has a split-able design for easy installation within a limited narrow space. Plus ease of maintenance due to the simplified disassembly design.

**3 High external static pressure, maximum 200 Pa\* setting**  
A high static pressure enables the use of long ducts for installation in a wide range of spaces.  
\* For model S-250PE4E.

**2 Easy pipe work with split-able hide-away indoor design**  
Heat exchanger and fan elements (fan + casing) can be separated during installation. The hide-away indoor unit is easily reassembled and will fit through a narrow space.

**4 Comfort operation**  
· nanoe™ X as standard for improved indoor air quality  
· Smartphone control-ready with the Panasonic Comfort Cloud App <sup>1)</sup>  
1) Panasonic Wi-Fi Adaptor CZ-CAPWFC2 is required.

**Improved indoor air quality with nanoe™ X**

The nanoe™ X technology is now available for the Big PACi NX range from 20,0-25,0 kW. The PE4 model is equipped with Generator Mark 3, generating 48 trillion hydroxyl radicals/sec, specifically designed to accommodate long duct piping applications.



**Maximum 200 Pa\* static pressure setting**  
A high static pressure enables the use of long ducts for installation in a wide range of spaces.



**3-step static pressure set up.**  
Selectable of static pressure modes can change 200 Pa / 130 Pa / 75 Pa for extra installation flexibility.

\* For model S-250PE4E.

**Easy installation with light components**  
Indoor unit can easily be split into 3 components, the heaviest of which weighs only 48 kg.

**Dimensions of each component (lightweight design for easy disassembly).**

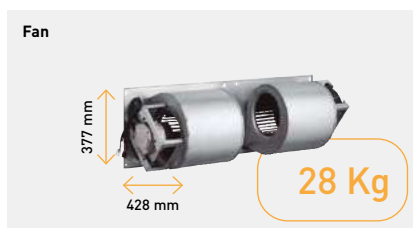
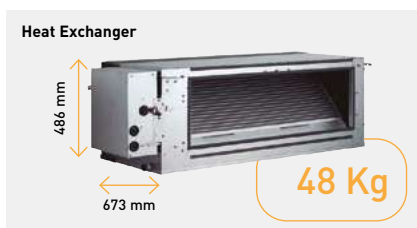

The weight is for S-250PE4E model.

## Jet Air Stream

Large spaces are often heated with boilers and unit heaters, which are inefficient, noisy, complex, and expensive fossil fuel systems that rarely offer summer cooling integration. The Jet Air Stream provides an efficient and sustainable solution for year-round heating and cooling in large spaces. It ensures optimal user comfort, a quiet environment, and is much easier to install than other systems.



**Efficient heating and cooling.**

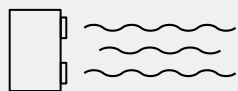

**Long air distribution.**

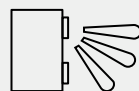

**Smart Jet - self-directing nozzles.**



**Quiet operation.**





The Jet Air Stream for the large spaces that require high air distribution, such as gymnasiums, production areas and warehouses.

+ SEE PRODUCT SPECIFICATIONS

**High air distribution for large spaces**

High air volume with a long air flow distance of up to 30 m ensures optimal comfort for large spaces like warehouses and gyms.

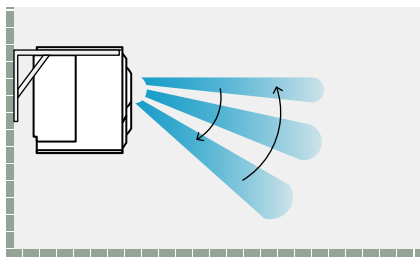
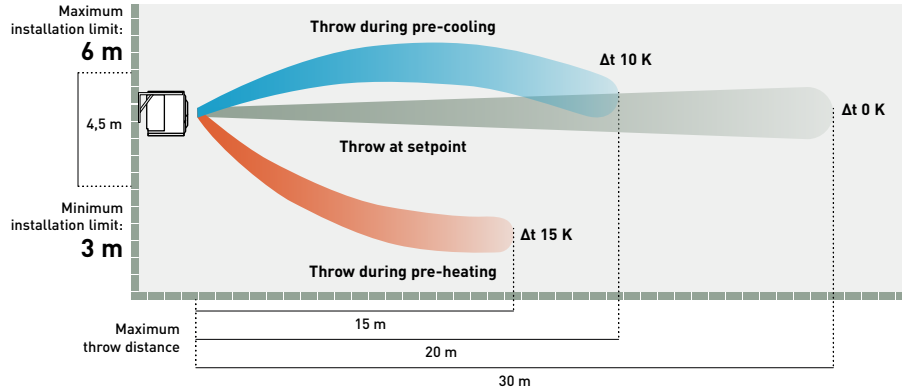

**Smart Jet - self-directing nozzles**

Jet Air Stream Smart models ensure optimal comfort by preventing heat loss. Nozzle movements adapt dynamically to incoming air temperature, preventing stratification and maintaining an ideal temperature exclusively in the occupied area.

**Jet Air Stream operation**

In cooling mode, the nozzle operation logic is inverted until the setpoint is reached

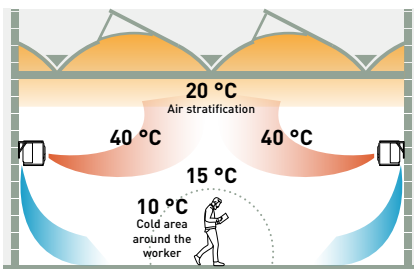

**Existing solution in heating.**

Air stratification occurs when warm air from the heating system rises to the top of the room, while cold air stays at the bottom. This is due to warm air being lighter and rising, and cooler air being denser and staying low.

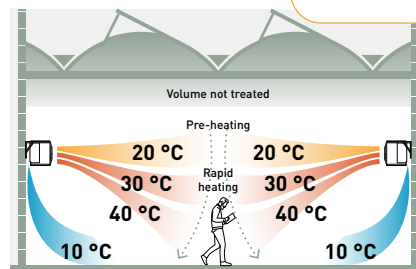

**Jet Air Stream operation in heating.**

**Pre-heating:** Upon start-up, the Jet Air Stream Smart directs the nozzles horizontally, preventing not-yet-warm air from blowing on people.  
**Rapid heating:** Once the air reaches the ideal temperature, power is maximised and the nozzles point downward, ensuring rapid heating of the occupied area.

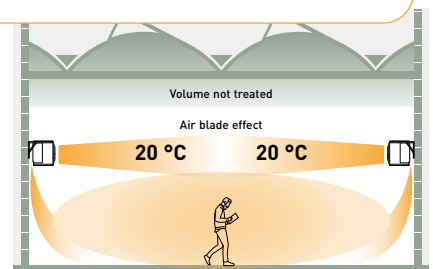

**Jet Air Stream operation in heating.**

**Maintenance with air blade effect:** Jet Air Stream Smart adjusts power once the desired temperature is reached. This aligns nozzles horizontally, creating an 'air blade' as a thermal barrier to optimise heat distribution and prevent upward dispersion.

Type	Jet Air Stream Smart		Jet Air Stream Standard		Jet Air Stream Ducted		
Air flow	m <sup>3</sup> /h	2500 m <sup>3</sup> /h	5000 m <sup>3</sup> /h	2500 m <sup>3</sup> /h	5000 m <sup>3</sup> /h	2500 m <sup>3</sup> /h	5000 m <sup>3</sup> /h
Model		P-VTVF140MC5-PE	P-VTVF250MC5-PE	P-VTVF140NC5-PE	P-VTVF250NC5-PE	P-VTVF140PC5-PE	P-VTVF250PC5-PE
Image		Smart Jet - self-directing nozzles		Manual nozzles		Ducted front panel	
Compatible outdoor unit		U-140PZH4E5/8	U-250PZH4E8	U-140PZH4E5/8	U-250PZH4E8	U-140PZH4E5/8	U-250PZH4E8

# Solutions for server rooms applications

Effectively protect your IT related spaces, 24/7, with a complete range of solutions offering redundancy control. High efficiency products provide reliable cooling all year round.



## YKEA server room solution.

- Perfect solution for smaller server rooms
- Compact design
- Reaching SEER value of 9,6 (A+++)<sup>1)</sup>
- High seasonal performance
- Range of capacities available
- Operation down to -25 °C ambient

<sup>1)</sup> For 3,5 kW unit.

## PACi NX solution.

- Scalability for larger applications
- Twin, triple and double-twin options<sup>1)</sup>
- Increased piping lengths of up to 90 m<sup>2)</sup>
- Increased sensible capacity options available
- Flexible and adaptable control options

<sup>1)</sup> Compatible with PAW-PACR4 only. <sup>2)</sup> For Big PACi NX 20 kW unit.

## Redundancy ensured by three different functionalities.

Computer and server rooms are very sensitive areas of application. Any downtime caused by high room temperatures must be avoided by any means. Air conditioner redundancy is one of the key points to ensure a reliable nonstop cooling operation.

### 1 Backup operation

When an air conditioner fails for whatever reason, another one will awake from standby mode and cover the room's cooling load.

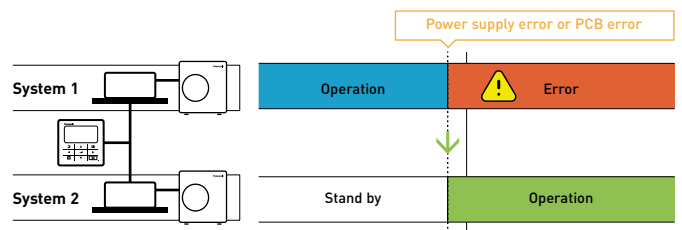

### 2 Support operation

Support operation, also called cascade control, makes sure that the capacity required to cool the room is delivered by one or more units whenever required. When the capacity of 1 air conditioner is not sufficient, another one will be started to support the operation.

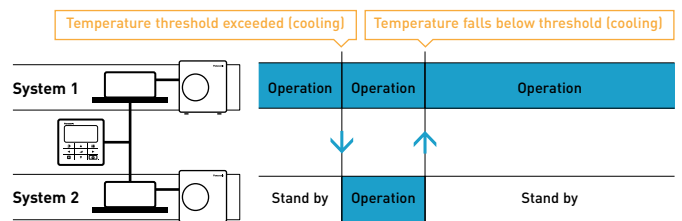

### 3 Rotation operation

Backup and support operation are key functions for a redundant operation in computer rooms. This concept implies a main system and a sub system. In order to avoid an imbalance of the operating hours of the systems, the redundancy control equalises the operation time by rotating the main and the sub systems, thus providing a "rotation operation".

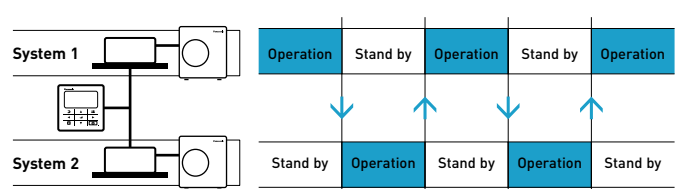

# Redundancy control options for 24/7/365 applications

## YKEA integral solution

- Ideal solution for small server rooms, providing full redundancy functionality integrated in YKEA's remote controller (requires optional CZ-RCC5 cable set)
- Up to 2 YKEA systems connectable to 1 remote controller
- Individual alarm display for each system
- Operation can be monitored by Panasonic Comfort Cloud App (via WLAN)
- No digital inputs/outputs

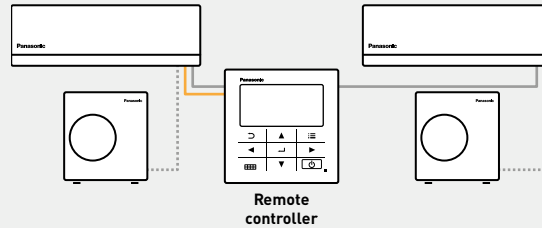

## Optional interface for YKEA units

### PAW-SERVER-PKEA

- Ideal solution for small server rooms, providing full redundancy functionality
- Up to 2 YKEA systems connectable to PAW-SERVER-PKEA
- Additional benefits: Operation and alarm outputs for each system, ON / OFF inputs for each system for connection to external BMS

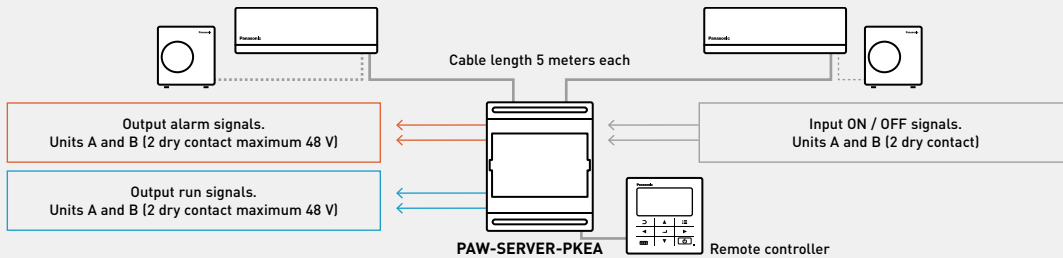

## PACi NX integral solution

### CZ-RTC5B / CZ-RTC6W / CZ-RTC6 / CZ-RTC6WBL / CZ-RTC6BL / CZ-RTC6WBLW2 / CZ-RTC6BLW2

- Full redundancy functionality
- Quick and easy installation using PACi NX group control
- Up to 2 PACi NX systems connectable to 1 remote controller
- Delta T setting for support operation selectable from 4 to 10 K
- Connectable to Panasonic centralised control systems
- Optional interfaces for connection to external BMS (Modbus, BACnet, KNX)

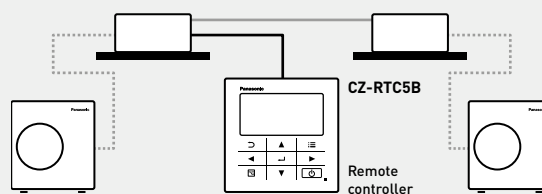

## Optional interface up to 4 indoor units PACi NX or VRF





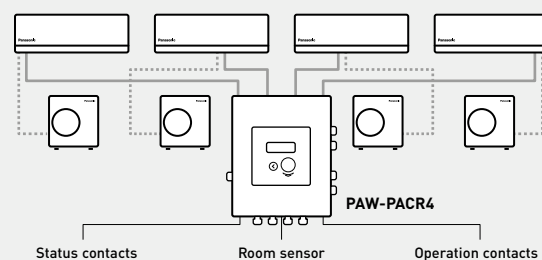





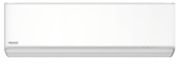
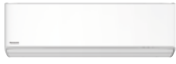
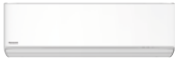
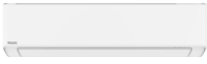
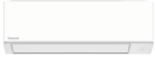
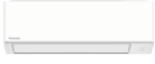
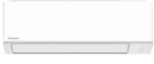















### PAW-PACR4

- Redundancy control up to 4 indoor unit groups
- Actual unit operation / alarm status can be displayed
- Common digital alarm / operation status output
- For each support operation level, individual temperature thresholds can be set (cascade control)
- Room temperature display (by device's own temperature sensor)
- Modbus connection (up to 4 PAW-RC2-MBS-1)
- Available external inputs (ON / OFF, heating/cooling change\*, fire prevention contact)



\* External input heating/cooling change only for the interface control logic, not for the indoor unit mode change.

# Commercial units range

Page	Indoor units	2,5 kW	3,6 kW	4,5 kW <sup>1)</sup>	5,0 kW	6,0 kW
P. 230	Wall-mounted Professional · R32 <sup>2)</sup>	 CS-Z25YKEA-1	 CS-Z35YKEA-1	 CS-Z42YKEA-1	 CS-Z50YKEA-1	
P. 232	<b>NEW</b> PACi NX wall-mounted · R32	 S-2545PK4E	 S-2545PK4E	 S-2545PK4E	 S-5010PK4E	 S-5010PK4E
P. 236	PACi NX 4 way 60x60 cassette · R32	 S-25PY3E	 S-36PY3E	 S-50PY3E	 S-60PY3E	
P. 238	PACi NX 4 way 90x90 cassette · R32		 S-3650PU3E	 S-3650PU3E	 S-3650PU3E	 S-6071PU3E
P. 242	PACi NX ceiling · R32		 S-3650PT3E	 S-3650PT3E	 S-3650PT3E	 S-6071PT3E
P. 246	PACi NX adaptive ducted · R32		 S-3650PF3E	 S-3650PF3E	 S-3650PF3E	 S-6071PF3E
P. 250	Big PACi NX high static pressure hide-away 20-25 kW · R32					
P. 251	PACi NX Jet Air Stream · R32					
	Outdoor units	2,5 kW	3,6 kW		5,0 kW	6,0 kW
	PACi NX Elite · R32 Big PACi NX (20,0-25,0 kW) · R32		 U-36PZH3E5		 U-50PZH3E5	 U-60PZH3E5
	PACi NX Standard · R32	 U-25PZ3E5	 U-36PZ3E5		 U-50PZ3E5	 U-60PZ3E5A

1) The 4,5 kW indoor capacity options are only available only for twin, triple and double-twin combinations. 2) Not compatible with PACi NX outdoors and accessories. Domestic range sales conditions may apply. Check with your sales representative.

\* U-\_\_E5 Single phase / U-\_\_E8 Three phase.

+ OPTIONAL UNITS ON VENTILATION SECTION

7,1 kW

10,0 kW

12,5 kW

14,0 kW

20,0 kW

25,0 kW

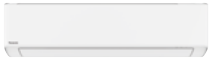

CS-Z71YKEA-1



S-5010PK4E



S-5010PK4E



S-6071PU3E



S-1014PU3E



S-1014PU3E



S-1014PU3E

A new panel in graphite black (RAL9011) is available.



S-6071PT3E



S-1014PT3E



S-1014PT3E



S-1014PT3E



S-6071PF3E



S-1014PF3E



S-1014PF3E



S-1014PF3E



S-200PE4E



S-250PE4E



P-VTVF140MC5-PE /  
P-VTVF140NC5-PE /  
P-VTVF140PC5-PE



P-VTVF250MC5-PE /  
P-VTVF250NC5-PE /  
P-VTVF250PC5-PE

7,1 kW

10,0 kW

12,5 kW

14,0 kW

20,0 kW

25,0 kW



U-71PZH4E5 / U-71PZH4E8



U-100PZH4E5 / U-100PZH4E8



U-125PZH4E5 / U-125PZH4E8



U-140PZH4E5 / U-140PZH4E8



U-200PZH4E8



U-250PZH4E8



U-71PZ3E5A



U-100PZ3E5 / U-100PZ3E8



U-125PZ3E5 / U-125PZ3E8



U-140PZ3E5 / U-140PZ3E8

## YKEA series for server rooms

High efficiency products for 24/7 applications. Panasonic has developed a complete range of solutions for server rooms which efficiently protect your servers, keeping them at an appropriate temperature even when the outdoor temperature is below -25 °C.



### 1 Designed for 24h/7d a week operation

High efficiency all year round. This wall-mounted air conditioner is designed for professional, critical applications such as computer rooms where reliable cooling inside the room is necessary even with extreme ambient conditions.

### 3 Highest energy rating in cooling

The SEER and SCOP of the Server room unit has been further improved to achieve top class energy efficiency. The 3,5 kW unit reaches now the SEER value of 9,6 (A+++).

### 2 Remote controller for better usability

Wired remote controller, which can assure the operation 24/7 of two server room units, thanks to the integrated duty rotation mode. This function manages rotation and backup of two units and it is available when connecting an optional CN-CNT cable (CZ-RCC5) between the controller and each of the two indoor units.

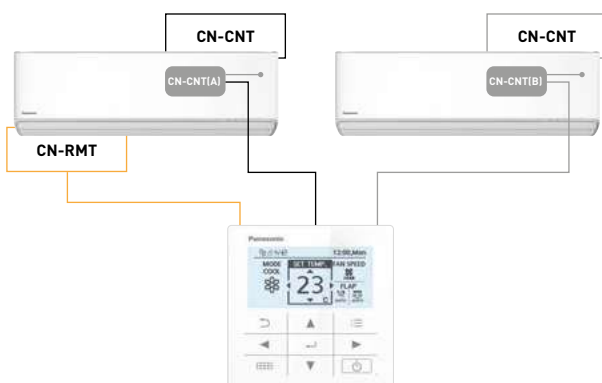

### 4 Built-in Wi-Fi and compatible with Voice Assistant

The unit is ready to connect to the internet and to be controlled by smartphone with Panasonic Comfort Cloud App. Control, monitor energy consumption statistics and easily identify errors in case of failure.



Not compatible with PACi NX outdoors and accessories. Domestic range sales conditions may apply. Check with your sales representative.

Wall-mounted Professional -25 °C · R32

- Designed for 24h/7d a week operation
- Wired remote controller, with optional duty rotation mode
- Improved SEER / SCOP to achieve top class energy efficiency
- Aerowings 2.0, for a better control of the air flow
- Built-in Wi-Fi for smart control via Panasonic Comfort Cloud App
- Compatible with Google Assistant and Amazon Alexa
- Chassis and parts designed for easier installation



Kit			KIT-Z25-YKEA-1	KIT-Z35-YKEA-1	KIT-Z42-YKEA-1	KIT-Z50-YKEA-1	KIT-Z71-YKEA-1
Cooling capacity	Nominal (Min - Max)	kW	2,50 (0,85 - 3,50)	3,50 (0,85 - 4,20)	4,20 (0,85 - 5,00)	5,00 (0,98 - 6,00)	7,10 (0,98 - 8,50)
EER <sup>1)</sup>	Nominal (Min - Max)	W/W	4,90 (4,72 - 3,98)	4,12 (4,72 - 3,68)	3,82 (4,72 - 3,25)	3,68 (3,92 - 3,16)	3,23 (2,33 - 2,83)
<b>SEER <sup>2)</sup></b>			<b>9,5 A+++</b>	<b>9,6 A+++</b>	<b>8,6 A+++</b>	<b>8,6 A+++</b>	<b>6,5 A++</b>
Pdesign		kW	2,50	3,50	4,20	5,00	7,10
Input power	Nominal (Min - Max)	kW	0,51 (0,18 - 0,88)	0,85 (0,18 - 1,14)	1,10 (0,18 - 1,54)	1,36 (0,25 - 1,90)	2,20 (0,42 - 3,00)
Annual energy consumption <sup>3)</sup>		kWh/a	92	128	171	203	382
Heating capacity	Nominal (Min - Max)	kW	3,40 (0,85 - 5,00)	4,00 (0,85 - 5,80)	5,30 (0,85 - 6,80)	5,80 (0,98 - 8,00)	8,20 (0,98 - 10,20)
Heating capacity at -7 °C		kW	3,05	3,40	4,11	4,80	6,31
COP <sup>1)</sup>	Nominal (Min - Max)	W/W	4,86 (4,72 - 3,97)	4,44 (4,72 - 3,87)	3,93 (4,72 - 3,66)	4,08 (4,26 - 3,35)	3,71 (2,45 - 3,29)
<b>SCOP <sup>2)</sup></b>			<b>4,6 A++</b>	<b>4,6 A++</b>	<b>4,5 A+</b>	<b>4,6 A++</b>	<b>4,1 A+</b>
Pdesign at -10 °C		kW	2,70	3,20	3,60	4,20	5,50
Input power	Nominal (Min - Max)	kW	0,70 (0,18 - 1,26)	0,90 (0,18 - 1,50)	1,35 (0,18 - 1,86)	1,42 (0,23 - 2,39)	2,21 (0,40 - 3,10)
Annual energy consumption <sup>3)</sup>		kWh/a	822	974	1120	1278	1878
<b>Indoor unit</b>			<b>CS-Z25YKEA-1</b>	<b>CS-Z35YKEA-1</b>	<b>CS-Z42YKEA-1</b>	<b>CS-Z50YKEA-1</b>	<b>CS-Z71YKEA-1</b>
Power supply		V	230	230	230	230	230
Recommended fuse		A	16	16	16	16	20
Connection indoor / outdoor		mm <sup>2</sup>	4x1,5	4x1,5	4x1,5	4x2,5	4x2,5
Air flow	Cool / Heat	m <sup>3</sup> /min	11,4/13,8	12,7/14,8	13,2/15,2	17,4/19,1	19,0/19,9
Moisture removal volume		L/h	1,5	2,0	2,4	2,8	4,1
Sound pressure <sup>4)</sup>	Cool (Hi / Lo / Q-Lo)	dB(A)	39/25/21	42/28/21	43/32/29	44/37/30	47/38/35
	Heat (Hi / Lo / Q-Lo)	dB(A)	41/27/22	43/30/22	44/35/29	44/37/30	47/38/35
Sound power	Cool / Heat (Hi)	dB(A)	55/57	58/59	59/60	60/60	63/63
Dimension	H x W x D	mm	295 x 870 x 229	295 x 870 x 229	295 x 870 x 229	295 x 1040 x 244	295 x 1040 x 244
Net weight		kg	11	11	11	12	13
<b>Outdoor unit</b>			<b>CU-Z25YKEA-1</b>	<b>CU-Z35YKEA-1</b>	<b>CU-Z42YKEA-1</b>	<b>CU-Z50YKEA-1</b>	<b>CU-Z71YKEA-1</b>
Air flow	Cool / Heat	m <sup>3</sup> /min	27,6/27,6	29,8/29,8	29,8/31,0	39,8/36,9	44,7/45,8
Sound pressure <sup>4)</sup>	Cool / Heat (Hi)	dB(A)	46/48	48/50	48/51	48/50	52/54
Sound power	Cool / Heat (Hi)	dB(A)	61/63	63/65	63/66	63/65	66/68
Dimension <sup>5)</sup>	H x W x D	mm	542 x 780 x 289	542 x 780 x 289	542 x 780 x 289	695 x 875 x 320	695 x 875 x 320
Net weight		kg	30	30	30	40	45
Piping diameter	Liquid	Inch (mm)	1/4 (6,35)	1/4 (6,35)	1/4 (6,35)	1/4 (6,35)	1/4 (6,35)
	Gas	Inch (mm)	3/8 (9,52)	3/8 (9,52)	1/2 (12,70)	1/2 (12,70)	5/8 (15,88)
Pipe length range		m	3 - 20	3 - 20	3 - 20	3 - 30	3 - 30
Elevation difference (in / out)		m	15	15	15	15	20
Pre-charged pipe length		m	7,5	7,5	7,5	7,5	10
Additional gas amount		g/m	10	10	10	15	25
Refrigerant (R32) / CO <sub>2</sub> Eq.		kg / T	0,89/0,60	0,89/0,60	0,97/0,65	1,13/0,76	1,35/0,91
Operating range	Cool Min ~ Max	°C	-25 ~ +43	-25 ~ +43	-25 ~ +43	-25 ~ +43	-25 ~ +43
	Heat Min ~ Max	°C	-15 ~ +24	-15 ~ +24	-15 ~ +24	-15 ~ +24	-15 ~ +24

1) EER and COP calculation is based in accordance to EN 14511. 2) Energy Label Scale from A+++ to D. 3) The annual energy consumption is calculated in accordance to EU/626/2011. 4) The sound pressure of the indoor unit shows the value measured of a position 1 m in front of the main body and 0,8 m below the unit. For outdoor unit 1 m in front and 1 m in rear side of main body. The sound pressure is measured in accordance with JIS C 9612. Q-Lo: Quiet mode. Lo: The lowest set fan speed. 5) Add 70 mm for piping port. \* Not compatible with PACi NX outdoors and accessories. Domestic range sales conditions may apply. Check with your sales representative.

Accessories	
<b>CZ-RCC5</b>	CN-CNT cables x2 for server room application, control of 2 units, rotation, backup, etc.
<b>PAW-WTRAY</b>	Tray for condenser water compatible with outdoor elevation platform

Accessories	
<b>PAW-GRDBSE20</b>	Outdoor base ground support for noise and vibration absorption
<b>PAW-GRDSTD40</b>	Outdoor elevation platform 400 x 900 x 400 mm



SEER: For KIT-Z35-YKEA-1. SCOP: For KIT-Z25-YKEA-1, KIT-Z35-YKEA-1 and KIT-Z50-YKEA-1. SUPER QUIET: For KIT-Z25-YKEA-1. INTERNET CONTROL: Built-in Wi-Fi.

Rating conditions: Cooling indoor 27 °C DB / 19 °C WB. Cooling outdoor 35 °C DB / 24 °C WB. Heating indoor 20 °C DB. Heating outdoor 7 °C DB / 6 °C WB. (DB: Dry Bulb; WB: Wet Bulb). Specifications subject to change without notice. For detailed information about ErP / Energy Labelling, please visit our websites www.aircon.panasonic.eu or www.ptc.panasonic.eu.

**NEW PACi NX Series Elite wall-mounted - PK4 · R32**

The wall-mounted units with stylish matt color can be offered for many applications such as studios, gyms, high ceiling areas and even computer server rooms.

The compact design and flat face ensure discreet installation, even in a small space.



			Single phase				
			3,6 kW	5,0 kW	6,0 kW	7,1 kW	10,0 kW
Kit			KIT-36PK4ZH5	KIT-50PK4ZH5	KIT-60PK4ZH5	KIT-71PK4ZH5	KIT-100PK4ZH5
Remote controller			CZ-RTC5B	CZ-RTC5B	CZ-RTC5B	CZ-RTC5B	CZ-RTC5B
Cooling capacity	Nominal (Min - Max)	kW	3,5(1,2 - 4,0)	5,0(1,2 - 5,6)	6,1(1,2 - 7,1)	7,1(2,2 - 9,0)	9,5(3,1 - 10,5)
EER <sup>1)</sup>	Nominal (Min - Max)	W/W	4,43(4,17 - 5,45)	4,10(3,03 - 5,45)	3,74(3,02 - 5,45)	3,76(2,69 - 5,79)	3,41(3,09 - 5,34)
<b>SEER<sup>2)</sup></b>			<b>7,7 A++</b>	<b>8,0 A++</b>	<b>7,1 A++</b>	<b>6,6 A++</b>	<b>6,6 A++</b>
Pdesign		kW	3,5	5,0	6,1	7,1	9,5
Input power	Nominal (Min - Max)	kW	0,79(0,22 - 0,96)	1,22(0,22 - 1,85)	1,63(0,22 - 2,35)	1,89(0,38 - 3,35)	2,79(0,58 - 3,40)
Annual energy consumption <sup>3)</sup>		kWh/a	160	219	301	377	504
Heating capacity	Nominal (Min - Max)	kW	4,0(1,2 - 5,0)	5,6(1,2 - 6,5)	7,0(1,2 - 8,0)	7,8(2,0 - 9,0)	9,5(3,1 - 11,5)
Heating capacity at -15 °C <sup>4)</sup>	Max	kW	3,4	5,0	5,1	5,8	8,9
COP <sup>1)</sup>	Nominal (Min - Max)	W/W	4,26(3,33 - 5,45)	4,03(3,10 - 5,45)	4,12(3,40 - 5,45)	4,00(3,16 - 5,56)	3,89(3,00 - 5,34)
<b>SCOP<sup>2)</sup></b>			<b>4,7 A++</b>	<b>4,6 A++</b>	<b>4,7 A++</b>	<b>4,6 A++</b>	<b>4,1 A+</b>
Pdesign at -10 °C		kW	3,1	4,5	4,6	5,2	8,0
Input power	Nominal (Min - Max)	kW	0,94(0,22 - 1,50)	1,39(0,22 - 2,10)	1,70(0,22 - 2,35)	1,95(0,36 - 2,85)	2,44(0,58 - 3,83)
Annual energy consumption <sup>3)</sup>		kWh/a	924	1369	1370	1583	2731
<b>Indoor unit</b>			<b>S-2545PK4E</b>	<b>S-5010PK4E</b>	<b>S-5010PK4E</b>	<b>S-5010PK4E</b>	<b>S-5010PK4E</b>
Air flow	Hi / Med / Lo	m <sup>3</sup> /min	11,5/9,5/7,0	17,0/15,5/12,0	21,0/19,0/16,5	21,0/19,0/16,5	22,5/20,0/17,5
Moisture removal volume		L/h	1,0	1,6	1,9	2,4	4,4
Sound pressure <sup>5)</sup>	Hi / Med / Lo	dB(A)	41/36/30	41/36/31	47/44/40	47/44/40	49/45/41
Sound power	Hi / Med / Lo	dB(A)	57/52/46	57/52/47	63/60/56	63/60/56	65/61/57
Dimension	HxWxD	mm	290x765x214	295x1060x249	295x1060x249	295x1060x249	295x1060x249
Net weight		kg	9	14	14	14	14
nanoe X Generator			Mark 3	Mark 3	Mark 3	Mark 3	Mark 3
<b>Outdoor unit</b>			<b>U-36PZH3E5</b>	<b>U-50PZH3E5</b>	<b>U-60PZH3E5</b>	<b>U-71PZH4E5</b>	<b>U-100PZH4E5</b>
Power supply		V	220 - 230 - 240	220 - 230 - 240	220 - 230 - 240	220 - 230 - 240	220 - 230 - 240
Current	Cool	A	3,90 - 3,75 - 3,60	5,80 - 5,55 - 5,30	7,65 - 7,30 - 7,00	9,55 - 9,15 - 8,75	13,80 - 13,20 - 12,60
	Heat	A	4,60 - 4,40 - 4,20	6,60 - 6,30 - 6,05	7,90 - 7,55 - 7,25	9,85 - 9,40 - 9,05	12,10 - 11,50 - 11,10
Air flow	Cool / Heat	m <sup>3</sup> /min	34,1/36,4	42,0/42,0	42,0/42,0	62,0/66,0	76,0/70,0
Sound pressure	Cool / Heat (Hi)	dB(A)	43/44	46/48	47/50	48/50	52/52
Sound power	Cool / Heat (Hi)	dB(A)	62/64	64/67	65/69	65/67	69/69
Dimension	HxWxD	mm	695x875x320	695x875x320	695x875x320	996x980x370	996x980x370
Net weight		kg	42	42	43	66	84
Piping diameter	Liquid	Inch (mm)	1/4 (6,35)	1/4 (6,35) <sup>6)</sup>	1/4 (6,35) <sup>6)</sup>	3/8 (9,52)	3/8 (9,52)
	Gas	Inch (mm)	1/2 (12,70)	1/2 (12,70) <sup>7)</sup>	1/2 (12,70) <sup>7)</sup>	5/8 (15,88)	5/8 (15,88)
Pipe length range		m	3 - 40	3 - 40	3 - 40	5 - 60	5 - 100
Elevation difference (in / out) <sup>8)</sup>		m	15/30	15/30	15/30	15/30	15/30
Pre-charged pipe length		m	30	30	30	30	30
Additional gas amount		g/m	15	15	15	30	40
Refrigerant (R32) / CO <sub>2</sub> Eq.		kg / T	1,13/0,76	1,13/0,76	1,15/0,78	1,95/1,32	2,70/1,82
Operating range	Cool Min ~ Max	°C	-15 ~ +46	-15 ~ +46	-15 ~ +46	-15 ~ +52	-20 <sup>9)</sup> ~ +52
	Heat Min ~ Max	°C	-20 ~ +24	-20 ~ +24	-20 ~ +24	-20 ~ +24	-20 ~ +24

**Technical focus**

- Modern, flat design with a stylish matte white finish featuring
- DC fan motor for better efficiency and control
- Five-direction automatic airflow adjustment for cooling and heating
- Six directional piping outlet
- Quiet operation
- nanoe™ X (Generator Mark 3: 48 trillion hydroxyl radicals/sec) as standard for better indoor air quality
- Wired remote control CZ-RTC6WBL and CZ-RTC6BL allows easy system setting via Bluetooth®
- Easy connection and control of external fan or ERV using the connector PAW-FDC on the indoor unit PCB. The external device can be controlled by the remote control of the Panasonic indoor unit

**Closed discharge port**

When the unit is turned OFF, the flap closes completely to prevent dust getting into the unit and to keep the equipment clean.

**Piping outlet in six directions**

Piping outlet is possible in six directions of; right, right rear, right bottom, left, left rear and left bottom, making the installation work more flexible.

**Air distribution is automatically altered depending on the operational mode of the unit**

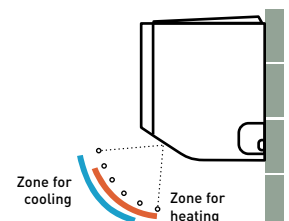





COMPATIBLE WITH ALL PANASONIC CONNECTIVITY SOLUTIONS. FOR DETAILED INFORMATION GO TO THE CONTROL SYSTEMS SECTION

Optional:



Three phase

Kit			7,1 kW	10,0 kW
			KIT-71PK4ZH48	KIT-100PK4ZH48
<b>Remote controller</b>			<b>CZ-RTC5B</b>	<b>CZ-RTC5B</b>
Cooling capacity	Nominal (Min - Max)	kW	7,1 (2,2 - 9,0)	9,5 (3,1 - 10,5)
EER <sup>1)</sup>	Nominal (Min - Max)	W/W	3,76 (2,69 - 5,79)	3,41 (3,09 - 5,34)
<b>SEER <sup>2)</sup></b>			<b>6,6 A++</b>	<b>6,6 A++</b>
Pdesign		kW	7,1	9,5
Input power	Nominal (Min - Max)	kW	1,89 (0,38 - 3,35)	2,79 (0,58 - 3,40)
Annual energy consumption <sup>3)</sup>		kWh/a	377	504
Heating capacity	Nominal (Min - Max)	kW	7,8 (2,0 - 9,0)	9,5 (3,1 - 11,5)
Heating capacity at -15 °C <sup>4)</sup>	Max	kW	5,8	8,9
COP <sup>1)</sup>	Nominal (Min - Max)	W/W	4,00 (3,16 - 5,56)	3,89 (3,00 - 5,34)
<b>SCOP <sup>2)</sup></b>			<b>4,6 A++</b>	<b>4,1 A+</b>
Pdesign at -10 °C		kW	5,2	8,0
Input power	Nominal (Min - Max)	kW	1,95 (0,36 - 2,85)	2,44 (0,58 - 3,83)
Annual energy consumption <sup>3)</sup>		kWh/a	1583	2731
<b>Indoor unit</b>			<b>S-5010PK4E</b>	<b>S-5010PK4E</b>
Air flow	Hi / Med / Lo	m <sup>3</sup> /min	21,0/19,0/16,5	22,5/20,0/17,5
Moisture removal volume		L/h	2,4	4,4
Sound pressure <sup>5)</sup>	Hi / Med / Lo	dB(A)	47/44/40	49/45/41
Sound power	Hi / Med / Lo	dB(A)	63/60/56	65/61/57
Dimension	H x W x D	mm	295 x 1060 x 249	295 x 1060 x 249
Net weight		kg	14	14
nanoe X Generator			Mark 3	Mark 3
<b>Outdoor unit</b>			<b>U-71PZH4E8</b>	<b>U-100PZH4E8</b>
Power supply		V	380 - 400 - 415	380 - 400 - 415
Current	Cool	A	3,20 - 3,05 - 3,00	4,65 - 4,45 - 4,20
	Heat	A	3,30 - 3,15 - 3,00	4,05 - 3,85 - 3,70
Air flow	Cool / Heat	m <sup>3</sup> /min	62,0/66,0	76,0/70,0
Sound pressure	Cool / Heat (Hi)	dB(A)	48/50	52/52
Sound power	Cool / Heat (Hi)	dB(A)	65/67	69/69
Dimension	H x W x D	mm	996 x 980 x 370	996 x 980 x 370
Net weight		kg	66	82
Piping diameter	Liquid	Inch (mm)	3/8 (9,52)	3/8 (9,52)
	Gas	Inch (mm)	5/8 (15,88)	5/8 (15,88)
Pipe length range		m	5 - 60	5 - 100
Elevation difference (in / out) <sup>8)</sup>		m	15/30	15/30
Pre-charged pipe length		m	30	30
Additional gas amount		g/m	30	40
Refrigerant (R32) / CO <sub>2</sub> Eq.		kg / T	1,95/1,32	2,70/1,82
Operating range	Cool Min ~ Max	°C	-15 ~ +52	-20 <sup>9)</sup> ~ +52
	Heat Min ~ Max	°C	-20 ~ +24	-20 ~ +24

1) EER and COP calculation is based in accordance to EN 14511. 2) For models below 12 kW, the SEER and SCOP is calculated based on values of EU/626/2011. For models above 12 kW, the  $\eta_{c}$  /  $\eta_{h}$  values is calculated based on EN 14825. 3) Factory setting. 4) The value is based on the interpolation. 5) The sound pressure of the units shows the value measured of the position 1 m in front of the main body and 1 m below the unit. The sound pressure is measured in accordance with Eurovent 6/C/006-97 specification. 6) Connect the liquid socket tube (Ø6,35-Ø9,52) to the liquid tubing side indoor unit. 7) Connect the gas socket tube (Ø12,70-Ø15,88) to the gas tubing side indoor unit. 8) Outdoor unit located lower / outdoor unit located higher. 9) Pipe length up to 30 m. \* Recommended fuse for the indoor 3 A. \*\* Above values are in the case of nanoe™ X OFF.

Accessories	
<b>CZ-RTC6W</b>	CONEX wired remote controller (non-wireless), white
<b>CZ-RTC6WBL</b>	CONEX wired remote controller with Bluetooth®, white
<b>CZ-RTC6WBLW2</b>	CONEX wired remote controller with Wi-Fi and Bluetooth®, white
<b>CZ-RTC6</b>	CONEX wired remote controller (non-wireless), black
<b>CZ-RTC6BL</b>	CONEX wired remote controller with Bluetooth®, black
<b>CZ-RTC6BLW2</b>	CONEX wired remote controller with Wi-Fi and Bluetooth®, black
<b>CZ-RTC5B</b>	Wired remote controller with Econavi function
<b>CZ-RWS3</b>	Infrared remote controller

Accessories	
<b>CZ-CAPWFC2</b>	Commercial Wi-Fi Adaptor
<b>PAW-PACR4</b>	Interface to run up to 4 indoor unit groups on backup and alternative run
<b>PAW-WTRAY</b>	Tray for condenser water compatible with outdoor elevation platform
<b>PAW-GRDBSE20</b>	Outdoor base ground support for noise and vibration absorption
<b>PAW-GRDSTD40</b>	Outdoor elevation platform 400x900x400 mm
<b>CZ-CENSC1</b>	Econavi energy saving sensor



SEER: For S-5010PK4E + U-50PZH3E5. SCOP: For S-2545PK4E + U-36PZH3E5 and S-5010PK4E + U-60PZH3E5. INTERNET CONTROL: Optional.

Rating conditions: Cooling indoor 27 °C DB / 19 °C WB. Cooling outdoor 35 °C DB / 24 °C WB. Heating indoor 20 °C DB. Heating outdoor 7 °C DB / 6 °C WB. (DB: Dry Bulb; WB: Wet Bulb). Specifications subject to change without notice. For detailed information about ErP / Energy Labelling, please visit our websites www.aircon.panasonic.eu or www.ptc.panasonic.eu.

**NEW PACi NX Series Standard wall-mounted - PK4 - R32**

The wall-mounted units with stylish matt color can be offered for many applications such as studios, gyms, high ceiling areas and even computer server rooms.

The compact design and flat face ensure discreet installation, even in a small space.



			Single phase					
			2,5 kW	3,6 kW	5,0 kW	6,0 kW	7,1 kW	10,0 kW
Kit			KIT-25PK4Z5	KIT-36PK4Z5	KIT-50PK4Z5	KIT-60PK4Z5	KIT-71PK4Z5	KIT-100PK4Z5
Remote controller			CZ-RTC5B	CZ-RTC5B	CZ-RTC5B	CZ-RTC5B	CZ-RTC5B	CZ-RTC5B
Cooling capacity	Nominal (Min - Max)	kW	2,5(1,3 - 3,9)	3,5(1,3 - 4,0)	5,0(1,5 - 5,6)	6,1(2,0 - 7,1)	6,9(2,6 - 7,7)	9,0(3,0 - 9,7)
EER <sup>1)</sup>	Nominal (Min - Max)	W/W	4,39(3,68 - 5,00)	3,89(3,74 - 5,00)	3,40(3,03 - 6,25)	3,57(3,01 - 6,90)	3,29(2,77 - 5,00)	3,23(3,13 - 5,36)
<b>SEER<sup>2)</sup></b>			<b>6,6 A++</b>	<b>6,8 A++</b>	<b>7,2 A++</b>	<b>7,0 A++</b>	<b>6,0 A+</b>	<b>6,2 A++</b>
Pdesign		kW	2,5	3,5	5,0	6,1	6,9	9,0
Input power	Nominal (Min - Max)	kW	0,57(0,26 - 1,06)	0,90(0,26 - 1,07)	1,47(0,24 - 1,85)	1,71(0,29 - 2,36)	2,10(0,52 - 2,78)	2,79(0,56 - 3,10)
Annual energy consumption <sup>3)</sup>		kWh/a	133	181	243	305	402	508
Heating capacity	Nominal (Min - Max)	kW	2,8(1,3 - 4,6)	3,6(1,3 - 4,6)	5,0(1,5 - 6,4)	6,1(1,8 - 7,0)	7,1(2,1 - 8,1)	9,0(3,0 - 10,5)
Heating capacity at -15 °C <sup>4)</sup>	Max	kW	2,8	2,9	4,4	5,1	5,8	9,7
COP <sup>1)</sup>	Nominal (Min - Max)	W/W	4,52(3,54 - 5,65)	4,09(3,54 - 5,65)	4,20(3,17 - 7,50)	4,27(3,18 - 7,50)	4,10(3,38 - 6,36)	3,81(3,56 - 5,36)
<b>SCOP<sup>2)</sup></b>			<b>4,2 A+</b>	<b>4,4 A+</b>	<b>4,4 A+</b>	<b>4,6 A++</b>	<b>4,4 A+</b>	<b>4,0 A+</b>
Pdesign at -10 °C		kW	2,5	2,6	4,0	4,6	5,2	8,8
Input power	Nominal (Min - Max)	kW	0,62(0,23 - 1,30)	0,88(0,23 - 1,30)	1,19(0,20 - 2,02)	1,43(0,24 - 2,20)	1,73(0,33 - 2,40)	2,36(0,56 - 2,95)
Annual energy consumption <sup>3)</sup>		kWh/a	833	827	1271	1400	1654	3080
<b>Indoor unit</b>			<b>S-2545PK4E</b>	<b>S-2545PK4E</b>	<b>S-5010PK4E</b>	<b>S-5010PK4E</b>	<b>S-5010PK4E</b>	<b>S-5010PK4E</b>
Air flow	Hi / Med / Lo	m <sup>3</sup> /min	10,5/9,0/7,0	11,5/9,5/7,0	17,0/15,5/12,0	21,0/19,0/16,5	21,0/19,0/16,5	22,5/20,0/17,5
Moisture removal volume		L/h	0,4	1,0	1,6	1,9	2,2	4,0
Sound pressure <sup>5)</sup>	Hi / Med / Lo	dB(A)	39/34/29	41/36/30	41/36/31	47/44/40	47/44/40	49/45/41
Sound power	Hi / Med / Lo	dB(A)	55/50/45	57/52/46	57/52/47	63/60/56	63/60/56	65/61/57
Dimension	HxWxD	mm	290x765x214	290x765x214	295x1060x249	295x1060x249	295x1060x249	295x1060x249
Net weight		kg	9	9	14	14	14	14
nanoe X Generator			Mark 3	Mark 3	Mark 3	Mark 3	Mark 3	Mark 3
<b>Outdoor unit</b>			<b>U-25PZ3E5</b>	<b>U-36PZ3E5</b>	<b>U-50PZ3E5</b>	<b>U-60PZ3E5A</b>	<b>U-71PZ3E5A</b>	<b>U-100PZ3E5</b>
Power supply		V	220 - 230 - 240	220 - 230 - 240	220 - 230 - 240	220 - 230 - 240	220 - 230 - 240	220 - 230 - 240
Current	Cool	A	2,70 - 2,60 - 2,45	4,15 - 4,00 - 3,85	6,80 - 6,50 - 6,25	7,95 - 7,60 - 7,25	9,75 - 9,30 - 8,95	13,9 - 13,3 - 12,8
	Heat	A	2,90 - 2,80 - 2,65	4,10 - 3,95 - 3,80	5,60 - 5,35 - 5,10	6,65 - 6,35 - 6,10	8,00 - 7,70 - 7,35	11,8 - 11,3 - 10,8
Air flow	Cool / Heat	m <sup>3</sup> /min	33,6/34,0	33,6/34,0	32,7/31,9	42,6/41,5	44,7/45,9	73,0/73,0
Sound pressure	Cool / Heat (Hi)	dB(A)	46/47	46/47	46/46	47/48	48/49	52/52
Sound power	Cool / Heat (Hi)	dB(A)	64/66	64/66	64/64	64/65	66/68	70/70
Dimension	HxWxD	mm	619x824x299	619x824x299	619x824x299	695x875x320	695x875x320	996x980x370
Net weight		kg	32	32	35	42	50	83
Piping diameter	Liquid	Inch (mm)	1/4 (6,35)	1/4 (6,35)	1/4 (6,35) <sup>6)</sup>	1/4 (6,35) <sup>4)</sup>	1/4 (6,35) <sup>6)</sup>	3/8 (9,52)
	Gas	Inch (mm)	1/2 (12,70)	1/2 (12,70)	1/2 (12,70) <sup>7)</sup>	1/2 (12,70) <sup>7)</sup>	5/8 (15,88)	5/8 (15,88)
Pipe length range		m	3~15	3~15	3~20	3~40	3~40	5~50
Elevation difference (in / out) <sup>8)</sup>		m	15/15	15/15	15/15	15/30	20/30	15/30
Pre-charged pipe length		m	7,5	7,5	7,5	30	30	30
Additional gas amount		g/m	10	10	15	15	17	45
Refrigerant (R32) / CO <sub>2</sub> Eq.		kg / T	0,87/0,59	0,87/0,59	1,14/0,77	1,15/0,78	1,32/0,89	2,4/1,62
Operating range	Cool Min ~ Max	°C	-10 ~ +43	-10 ~ +43	-10 ~ +43	-10 ~ +43	-10 ~ +43	-10 ~ +43
	Heat Min ~ Max	°C	-15 ~ +24	-15 ~ +24	-15 ~ +24	-15 ~ +24	-15 ~ +24	-15 ~ +24

**Technical focus**

- Modern, flat design with a stylish matte white finish featuring
- DC fan motor for better efficiency and control
- Five-direction automatic airflow adjustment for cooling and heating
- Six directional piping outlet
- Quiet operation
- nanoe™ X (Generator Mark 3: 48 trillion hydroxyl radicals/sec) as standard for better indoor air quality
- Wired remote control CZ-RTC6WBL and CZ-RTC6BL allows easy system setting via Bluetooth®
- Easy connection and control of external fan or ERV using the connector PAW-FDC on the indoor unit PCB. The external device can be controlled by the remote control of the Panasonic indoor unit

**Closed discharge port**

When the unit is turned OFF, the flap closes completely to prevent dust getting into the unit and to keep the equipment clean.

**Piping outlet in six directions**

Piping outlet is possible in six directions of; right, right rear, right bottom, left, left rear and left bottom, making the installation work more flexible.

**Air distribution is automatically altered depending on the operational mode of the unit**

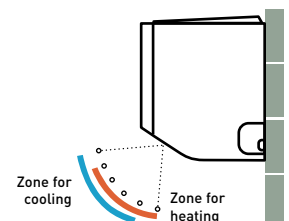

CZ-RTC5B



+ COMPATIBLE WITH ALL PANASONIC CONNECTIVITY SOLUTIONS. FOR DETAILED INFORMATION GO TO THE CONTROL SYSTEMS SECTION

Optional:



**CONEX**  
CONEX wired remote controller, white. CZ-RTC6W/BL/BLW2



**CONEX**  
CONEX wired remote controller, black. CZ-RTC6/BL/BLW2



Infrared remote controller. CZ-RWS3



Econavi sensor. CZ-CENSC1

			Three phase
			10,0 kW
			KIT-100PK4Z8
			CZ-RTC5B
<b>Kit</b>			
<b>Remote controller</b>			
Cooling capacity	Nominal (Min - Max)	kW	9,0 (3,0 - 9,7)
EER <sup>1)</sup>	Nominal (Min - Max)	W/W	3,23 (3,13 - 5,36)
<b>SEER <sup>2)</sup></b>			<b>6,2 A++</b>
Pdesign		kW	9,0
Input power	Nominal (Min - Max)	kW	2,79 (0,56 - 3,10)
Annual energy consumption <sup>3)</sup>		kWh/a	508
Heating capacity	Nominal (Min - Max)	kW	9,0 (3,0 - 10,5)
Heating capacity at -15 °C <sup>4)</sup>	Max	kW	9,7
COP <sup>1)</sup>	Nominal (Min - Max)	W/W	3,81 (3,56 - 5,36)
<b>SCOP <sup>2)</sup></b>			<b>4,0 A+</b>
Pdesign at -10 °C		kW	8,8
Input power	Nominal (Min - Max)	kW	2,36 (0,56 - 2,95)
Annual energy consumption <sup>3)</sup>		kWh/a	3080
<b>Indoor unit</b>			<b>S-5010PK4E</b>
Air flow	Hi / Med / Lo	m <sup>3</sup> /min	22,5 / 20,0 / 17,5
Moisture removal volume		L/h	4,0
Sound pressure <sup>5)</sup>	Hi / Med / Lo	dB(A)	49 / 45 / 41
Sound power	Hi / Med / Lo	dB(A)	65 / 61 / 57
Dimension	H x W x D	mm	295 x 1060 x 249
Net weight		kg	14
nanoe X Generator			Mark 3
<b>Outdoor unit</b>			<b>U-100PZ3E8</b>
Power supply		V	380 - 400 - 415
Current	Cool	A	4,65 - 4,45 - 4,25
	Heat	A	3,95 - 3,75 - 3,60
Air flow	Cool / Heat	m <sup>3</sup> /min	73,0 / 73,0
Sound pressure	Cool / Heat (Hi)	dB(A)	52 / 52
Sound power	Cool / Heat (Hi)	dB(A)	70 / 70
Dimension	H x W x D	mm	996 x 980 x 370
Net weight		kg	83
Piping diameter	Liquid	Inch (mm)	3/8 (9,52)
	Gas	Inch (mm)	5/8 (15,88)
Pipe length range		m	5 - 50
Elevation difference (in / out) <sup>8)</sup>		m	15 / 30
Pre-charged pipe length		m	30
Additional gas amount		g/m	45
Refrigerant (R32) / CO <sub>2</sub> Eq.		kg / T	2,4 / 1,62
Operating range	Cool Min ~ Max	°C	-10 ~ +43
	Heat Min ~ Max	°C	-15 ~ +24

1) EER and COP calculation is based in accordance to EN 14511. 2) For models below 12 kW, the SEER and SCOP is calculated based on values of EU/626/2011. For models above 12 kW, the  $\eta_{s,c} / \eta_{s,h}$  values is calculated based on EN 14825. 3) Factory setting. 4) The value is based on the interpolation. 5) The sound pressure of the units shows the value measured of the position 1 m in front of the main body and 1 m below the unit. The sound pressure is measured in accordance with Eurovent 6/C/006-97 specification. 6) Connect the liquid socket tube (Ø6,35-Ø9,52) to the liquid tubing side indoor unit. 7) Connect the gas socket tube (Ø12,70-Ø15,88) to the gas tubing side indoor unit. 8) Outdoor unit located lower / outdoor unit located higher. \* Recommended fuse for the indoor 3 A. \*\* Above values are in the case of nanoe™ X OFF.

Accessories

<b>CZ-RTC6W</b>	CONEX wired remote controller (non-wireless), white
<b>CZ-RTC6WBL</b>	CONEX wired remote controller with Bluetooth®, white
<b>CZ-RTC6WBLW2</b>	CONEX wired remote controller with Wi-Fi and Bluetooth®, white
<b>CZ-RTC6</b>	CONEX wired remote controller (non-wireless), black
<b>CZ-RTC6BL</b>	CONEX wired remote controller with Bluetooth®, black
<b>CZ-RTC6BLW2</b>	CONEX wired remote controller with Wi-Fi and Bluetooth®, black
<b>CZ-RTC5B</b>	Wired remote controller with Econavi function
<b>CZ-RWS3</b>	Infrared remote controller

Accessories

<b>CZ-CAPWFC2</b>	Commercial Wi-Fi Adaptor
<b>PAW-PACR4</b>	Interface to run up to 4 indoor unit groups on backup and alternative run
<b>PAW-WTRAY</b>	Tray for condenser water compatible with outdoor elevation platform
<b>PAW-GRDBSE20</b>	Outdoor base ground support for noise and vibration absorption
<b>PAW-GRDSTD40</b>	Outdoor elevation platform 400x900x400 mm
<b>CZ-CENSC1</b>	Econavi energy saving sensor



SEER: For S-5010PK4E + U-50PZ3E5. SCOP: For S-5010PK4E + U-60PZ3E5A. INTERNET CONTROL: Optional.

Rating conditions: Cooling indoor 27 °C DB / 19 °C WB. Cooling outdoor 35 °C DB / 24 °C WB. Heating indoor 20 °C DB. Heating outdoor 7 °C DB / 6 °C WB. (DB: Dry Bulb, WB: Wet Bulb). Specifications subject to change without notice. For detailed information about ErP / Energy Labelling, please visit our websites www.aircon.panasonic.eu or www.ptc.panasonic.eu.

## PACi NX Series Elite and Standard 4 way 60x60 cassette - PY3 - R32

- From 2,5 to 6,0 kW (4 capacity sizes)
- Maximum SEER: 7,3 A++ / SCOP: 4,7 A++\*
- Built-in drain pump
- DC drain pump and float switch to reduce the noise
- nanoe™ X (Generator Mark 2: 9,6 trillion hydroxyl radicals/sec) as standard for better indoor air quality



\* For Elite 3,6 kW model.

Elite			Single phase		
			3,6 kW	5,0 kW	6,0 kW
Kit			KIT-36PY3ZH5	KIT-50PY3ZH5	KIT-60PY3ZH5
Remote controller			CZ-RTC5B	CZ-RTC5B	CZ-RTC5B
Cooling capacity	Nominal (Min - Max)	kW	3,6(1,2 - 4,0)	5,0(1,2 - 5,6)	6,0(1,2 - 6,5)
EER <sup>1)</sup>	Nominal (Min - Max)	W/W	4,50(4,04 - 5,45)	3,76(3,41 - 5,45)	3,43(2,77 - 5,45)
<b>SEER<sup>2)</sup></b>			<b>7,3 A++</b>	<b>7,0 A++</b>	<b>6,7 A++</b>
Pdesign		kW	3,6	5,0	6,0
Input power	Nominal (Min - Max)	kW	0,80(0,22 - 0,99)	1,33(0,22 - 1,64)	1,75(0,20 - 2,35)
Annual energy consumption <sup>3)</sup>		kWh/a	400	685	875
Heating capacity	Nominal (Min - Max)	kW	4,0(1,2 - 5,0)	5,6(1,2 - 6,5)	7,0(1,2 - 7,5)
Heating capacity at -15 °C <sup>4)</sup>	Max	kW	3,2	4,1	4,8
COP <sup>1)</sup>	Nominal (Min - Max)	W/W	4,12(3,45 - 5,45)	3,37(2,95 - 5,45)	3,35(3,38 - 5,45)
<b>SCOP<sup>2)</sup></b>			<b>4,7 A++</b>	<b>4,6 A++</b>	<b>4,3 A+</b>
Pdesign at -10 °C		kW	3,6	4,5	4,6
Input power	Nominal (Min - Max)	kW	0,97(0,22 - 1,45)	1,66(0,22 - 2,20)	2,09(0,22 - 2,22)
Annual energy consumption <sup>3)</sup>		kWh/a	1073	1370	1495
<b>Indoor unit</b>			<b>S-36PY3E</b>	<b>S-50PY3E</b>	<b>S-60PY3E</b>
Air flow	Hi / Med / Lo	m <sup>3</sup> /min	9,5/7,5/6,0	12,0/9,5/6,5	14,0/10,5/8,0
Moisture removal volume		L/h	1,5	2,5	2,8
Sound pressure <sup>5)</sup>	Hi / Med / Lo	dB(A)	34/30/25	39/34/27	43/37/31
Sound power	Hi / Med / Lo	dB(A)	49/45/40	54/49/42	58/52/46
Dimension	Indoor (HxWxD)	mm	243x575x575	243x575x575	243x575x575
	Panel (HxWxD)	mm	30x625x625	30x625x625	30x625x625
Net weight	Indoor / Panel	kg	15/2,8	15/2,8	15/2,8
nanoe X Generator			Mark 2	Mark 2	Mark 2
<b>Outdoor unit</b>			<b>U-36PZH3E5</b>	<b>U-50PZH3E5</b>	<b>U-60PZH3E5</b>
Power supply		V	220 - 230 - 240	220 - 230 - 240	220 - 230 - 240
Current	Cool	A	3,95 - 3,60 - 3,60	5,30 - 5,00 - 5,75	8,20 - 7,85 - 7,60
	Heat	A	4,75 - 4,55 - 4,35	7,85 - 7,50 - 7,20	9,70 - 9,25 - 8,90
Air flow	Cool / Heat	m <sup>3</sup> /min	34,1/36,4	42,0/42,0	42,0/42,0
Sound pressure	Cool / Heat (Hi)	dB(A)	43/44	46/48	47/50
Sound power	Cool / Heat (Hi)	dB(A)	62/64	64/67	65/69
Dimension	HxWxD	mm	695x875x320	695x875x320	695x875x320
Net weight		kg	42	42	43
Piping diameter	Liquid	Inch (mm)	1/4 (6,35)	1/4 (6,35)	1/4 (6,35) <sup>6)</sup>
	Gas	Inch (mm)	1/2(12,70)	1/2(12,70)	1/2(12,70) <sup>7)</sup>
Pipe length range		m	3 - 40	3 - 40	3 - 40
Elevation difference (in / out) <sup>8)</sup>		m	15/30	15/30	15/30
Pre-charged pipe length		m	30	30	30
Additional gas amount		g/m	15	15	15
Refrigerant (R32) / CO <sub>2</sub> Eq.		kg / T	1,13/0,76	1,13/0,76	1,15/0,78
Operating range	Cool Min ~ Max	°C	-15 ~ +46	-15 ~ +46	-15 ~ +46
	Heat Min ~ Max	°C	-20 ~ +24	-20 ~ +24	-20 ~ +24

### Compact and stylish design

- Required ceiling depth of only 250 mm
- Exposed area is only 30 mm

### Individual flap control

Better control of the air flow with 4 motors, providing individual flap control.

Perfect air distribution without direct air flow, to reduce the feeling of cold drafts.

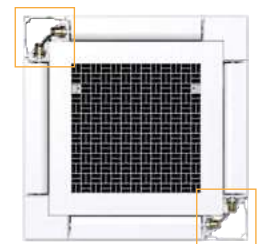

SEER and SCOP: For S-36PY3E + U-36PZH3E5. ECONAVI and INTERNET CONTROL: Optional.



Panel.  
CZ-KPY4

COMPATIBLE WITH ALL PANASONIC CONNECTIVITY SOLUTIONS. FOR DETAILED INFORMATION GO TO THE CONTROL SYSTEMS SECTION

Optional:



CONEX wired remote controller, white. CZ-RTC6W/BL/BLW2



CONEX wired remote controller, black. CZ-RTC6/BL/BLW2



Infrared remote controller. CZ-RWS3 + CZ-RRWY3

Econavi sensor. CZ-CENSC1

Standard

Single phase

			2,5 kW	3,6 kW	5,0 kW	6,0 kW
Kit			KIT-25PY3Z5	KIT-36PY3Z5	KIT-50PY3Z5	KIT-60PY3Z5
Remote controller			CZ-RTC5B	CZ-RTC5B	CZ-RTC5B	CZ-RTC5B
Cooling capacity	Nominal (Min - Max)	kW	2,5(1,5 - 3,9)	3,6(1,5 - 4,0)	5,0(1,5 - 5,6)	6,0(2,0 - 7,0)
EER <sup>1)</sup>	Nominal (Min - Max)	W/W	4,46(3,55 - 5,88)	3,96(3,57 - 5,88)	3,50(3,03 - 6,25)	3,39(2,77 - 6,90)
SEER <sup>2)</sup>			6,5 A++	6,7 A++	7,3 A++	6,8 A++
Pdesign		kW	2,5	3,6	5,0	6,0
Input power	Nominal (Min - Max)	kW	0,56(0,26 - 1,10)	0,91(0,26 - 1,12)	1,43(0,24 - 1,85)	1,77(0,29 - 2,53)
Annual energy consumption <sup>3)</sup>		kWh/a	134	188	238	3,05
Heating capacity	Nominal (Min - Max)	kW	3,2(1,5 - 4,6)	3,6(1,5 - 4,6)	5,0(1,5 - 6,4)	6,0(1,8 - 7,0)
Heating capacity at -15 °C <sup>4)</sup>	Max	kW	2,6	2,6	3,7	4,7
COP <sup>1)</sup>	Nominal (Min - Max)	W/W	4,44(3,41 - 6,52)	4,29(3,38 - 6,52)	3,94(2,91 - 7,50)	3,61(2,86 - 7,60)
SCOP <sup>2)</sup>			4,6 A++	4,3 A+	4,4 A+	4,2 A+
Pdesign at -10 °C		kW	2,8	2,8	4,0	4,6
Input power	Nominal (Min - Max)	kW	0,72(0,23 - 1,35)	0,84(0,23 - 1,36)	1,27(0,20 - 2,20)	1,66(0,24 - 2,45)
Annual energy consumption <sup>3)</sup>		kWh/a	850	912	1264	1500
Indoor unit			S-25PY3E	S-36PY3E	S-50PY3E	S-60PY3E
Air flow	Hi / Med / Lo	m <sup>3</sup> /min	8,5/7,0/6,0	9,5/7,0/6,0	12,0/9,5/6,5	14,0/10,5/8,0
Moisture removal volume		L/h	0,7	1,5	2,3	2,8
Sound pressure <sup>5)</sup>	Hi / Med / Lo	dB(A)	31/28/25	34/30/25	39/34/27	43/37/31
Sound power	Hi / Med / Lo	dB(A)	46/43/40	49/45/40	54/49/42	58/52/46
Dimension	Indoor (HxWxD)	mm	243x575x575	243x575x575	243x575x575	243x575x575
	Panel (HxWxD)	mm	30x625x625	30x625x625	30x625x625	30x625x625
Net weight	Indoor / Panel	kg	15/2,8	15/2,8	15/2,8	15/2,8
nanoe X Generator			Mark 2	Mark 2	Mark 2	Mark 2
Outdoor unit			U-25PZ3E5	U-36PZ3E5	U-50PZ3E5	U-60PZ3E5A
Power supply		V	220 - 230 - 240	220 - 230 - 240	220 - 230 - 240	220 - 230 - 240
Current	Cool	A	2,65 - 2,55 - 2,45	4,20 - 4,05 - 3,85	6,65 - 6,35 - 6,10	8,20 - 7,85 - 7,55
	Heat	A	3,40 - 3,25 - 3,10	3,95 - 3,75 - 3,60	5,695 - 5,70 - 5,45	7,70 - 7,35 - 7,05
Air flow	Cool / Heat	m <sup>3</sup> /min	33,6/34,0	32,6/34,0	32,7/31,9	42,6/41,5
Sound pressure	Cool / Heat (Hi)	dB(A)	46/47	46/47	46/48	47/48
Sound power	Cool / Heat (Hi)	dB(A)	64/66	64/66	64/64	64/65
Dimension	HxWxD	mm	619x824x299	619x824x299	619x824x299	695x875x320
Net weight		kg	32	32	35	46
Piping diameter	Liquid	Inch (mm)	1/4 (6,35)	1/4 (6,35)	1/4 (6,35)	1/4 (6,35) <sup>6)</sup>
	Gas	Inch (mm)	1/2(12,70)	1/2(12,70)	1/2(12,70)	1/2(12,70) <sup>6)</sup>
Pipe length range		m	3~15	3~15	3~20	3~40
Elevation difference (in / out) <sup>8)</sup>		m	15/15	15/15	15/15	15/30
Pre-charged pipe length		m	7,5	7,5	7,5	30
Additional gas amount		g/m	10	10	15	15
Refrigerant (R32) / CO <sub>2</sub> Eq.		kg / T	0,87/0,59	0,87/0,59	1,14/0,77	1,15/0,78
Operating range	Cool Min ~ Max	°C	-10 ~ +43	-10 ~ +43	-10 ~ +43	-10 ~ +43
	Heat Min ~ Max	°C	-15 ~ +24	-15 ~ +24	-15 ~ +24	-15 ~ +24

1) EER and COP calculation is based in accordance to EN 14511. 2) For models below 12 kW, the SEER and SCOP is calculated based on values of EU/626/2011. For models above 12 kW, the  $\eta_{e,c}$  /  $\eta_{e,h}$  values is calculated based on EN 14825. 3) Factory setting. 4) The value is based on the interpolation. 5) The sound pressure of the units shows the value measured of the position 1,5 m below the unit. The sound pressure is measured in accordance with Eurovent 6/C/006-97 specification. 6) Connect the liquid socket tube (Ø6,35-Ø9,52) to the liquid tubing side indoor unit. 7) Connect the gas socket tube (Ø12,70-Ø15,88) to the gas tubing side indoor unit. 8) Outdoor unit located lower / outdoor unit located higher. \* Recommended fuse for the indoor 3 A. \*\* Above values are in the case of nanoe™ X OFF.

Accessories

<b>CZ-RTC6W</b>	CONEX wired remote controller (non-wireless), white
<b>CZ-RTC6WBL</b>	CONEX wired remote controller with Bluetooth®, white
<b>CZ-RTC6WBLW2</b>	CONEX wired remote controller with Wi-Fi and Bluetooth®, white
<b>CZ-RTC6</b>	CONEX wired remote controller (non-wireless), black
<b>CZ-RTC6BL</b>	CONEX wired remote controller with Bluetooth®, black
<b>CZ-RTC6BLW2</b>	CONEX wired remote controller with Wi-Fi and Bluetooth®, black
<b>CZ-RTC5B</b>	Wired remote controller with Econavi function
<b>CZ-RWS3 + CZ-RRWY3</b>	Infrared remote controller and receiver

Accessories

<b>CZ-CAPWFC2</b>	Commercial Wi-Fi Adaptor
<b>PAW-PACR4</b>	Interface to run up to 4 indoor unit groups on backup and alternative run
<b>PAW-WTRAY</b>	Tray for condenser water compatible with outdoor elevation platform
<b>PAW-GRDBSE20</b>	Outdoor base ground support for noise and vibration absorption
<b>PAW-GRDSTD40</b>	Outdoor elevation platform 400x900x400 mm
<b>CZ-CENSC1</b>	Econavi energy saving sensor



SEER: For S-50PY3E + U-50PZ3E5. SCOP: For S-25PY3E + U-25PZ3E5. ECONAVI and INTERNET CONTROL: Optional.

Rating conditions: Cooling indoor 27 °C DB / 19 °C WB. Cooling outdoor 35 °C DB / 24 °C WB. Heating indoor 20 °C DB. Heating outdoor 7 °C DB / 6 °C WB. (DB: Dry Bulb; WB: Wet Bulb). Specifications subject to change without notice. For detailed information about ErP / Energy Labelling, please visit our websites www.aircon.panasonic.eu or www.ptc.panasonic.eu.

## PACi NX Series Elite 4 way 90x90 cassette - PU3 - R32

## 4 way 90x90 cassette - PU3.

Powerful turbo fan and intelligent Econavi sensor ensure high energy efficiency, and nanoe™ X, which is equipped as standard, provides an exceptional level of indoor air quality.



			Single phase						
			3,6 kW	5,0 kW	6,0 kW	7,1 kW	10,0 kW	12,5 kW	14,0 kW
Kit			KIT-36PU3ZH5	KIT-50PU3ZH5	KIT-60PU3ZH5	KIT-71PU3ZH45	KIT-100PU3ZH45	KIT-125PU3ZH45	KIT-140PU3ZH45
Remote controller			CZ-RTC5B	CZ-RTC5B	CZ-RTC5B	CZ-RTC5B	CZ-RTC5B	CZ-RTC5B	CZ-RTC5B
Cooling capacity	Nom (Min - Max)	kW	3,6(1,2 - 4,0)	5,0(1,2 - 5,6)	6,0(1,2 - 7,1)	7,1(2,2 - 9,0)	9,5(3,1 - 12,5)	12,5(3,2 - 14,0)	13,4(3,3 - 16,0)
EER <sup>1)</sup>	Nom (Min - Max)	W/W	5,45(4,60 - 5,45)	4,31(3,86 - 5,45)	4,05(3,02 - 5,45)	4,06(2,69 - 5,79)	4,42(3,42 - 5,34)	3,80(3,08 - 5,33)	3,60(2,74 - 5,32)
<b>SEER / η<sub>s,c</sub><sup>2)</sup></b>			<b>8,9 A+++</b>	<b>8,6 A+++</b>	<b>8,0 A++</b>	<b>7,7 A++</b>	<b>7,8 A++</b>	<b>304,3%</b>	<b>286,6%</b>
Pdesign		kW	3,6	5,0	6,0	7,1	9,5	12,5	13,4
Input power	Nom (Min - Max)	kW	0,66(0,22 - 0,87)	1,16(0,22 - 1,45)	1,48(0,22 - 2,35)	1,75(0,38 - 3,35)	2,15(0,58 - 3,65)	3,29(0,60 - 4,55)	3,72(0,62 - 5,85)
Annual energy consumption <sup>3)</sup>		kWh/a	142	203	263	323	426	—	—
Heating capacity	Nom (Min - Max)	kW	4,0(1,2 - 5,0)	5,6(1,2 - 6,5)	7,0(1,2 - 8,0)	8,0(2,0 - 9,0)	11,2(3,1 - 14,0)	14,0(3,2 - 16,0)	16,0(3,3 - 18,0)
Heating capacity at -15 °C <sup>4)</sup>	Max	kW	3,2	4,1	5,1	7,5	11,9	13,4	15,0
COP <sup>1)</sup>	Nom (Min - Max)	W/W	5,41(4,55 - 5,45)	4,24(4,19 - 5,45)	4,02(3,40 - 5,45)	4,30(3,16 - 5,56)	5,00(3,64 - 5,54)	4,61(3,37 - 5,52)	4,30(3,27 - 5,50)
<b>SCOP / η<sub>s,h</sub><sup>2)</sup></b>			<b>5,1 A+++</b>	<b>4,9 A++</b>	<b>4,8 A++</b>	<b>4,8 A++</b>	<b>4,9 A++</b>	<b>186,0%</b>	<b>181,2%</b>
Pdesign at -10 °C		kW	3,6	4,5	4,7	5,2	8,0	9,5	10,6
Input power	Nom (Min - Max)	kW	0,74(0,22 - 1,10)	1,32(0,22 - 1,55)	1,74(0,22 - 2,35)	1,86(0,36 - 2,85)	2,24(0,56 - 3,85)	3,04(0,58 - 4,75)	3,72(0,60 - 5,50)
Annual energy consumption <sup>3)</sup>		kWh/a	988	1286	1371	1517	2286	—	—
<b>Indoor unit</b>			<b>S-3650PU3E</b>	<b>S-3650PU3E</b>	<b>S-6071PU3E</b>	<b>S-6071PU3E</b>	<b>S-1014PU3E</b>	<b>S-1014PU3E</b>	<b>S-1014PU3E</b>
Air flow	Hi / Med / Lo	m <sup>3</sup> /min	14,5/13,0/11,5	16,5/13,5/11,5	21,0/16,0/13,0	22,0/16,0/13,0	36,0/26,0/18,0	37,0/27,0/19,0	38,0/29,0/20,0
Moisture removal volume		L/h	0,7	1,6	1,7	2,5	1,9	4,8	4,9
Sound pressure <sup>5)</sup>	Hi / Med / Lo	dB(A)	30/28/27	32/29/27	36/31/28	37/31/28	45/38/32	46/39/33	47/40/34
Sound power	Hi / Med / Lo	dB(A)	45/43/42	47/44/42	51/46/43	52/46/43	60/53/47	61/54/48	62/55/49
Dimension	Indoor (H x W x D)	mm	256 x 840 x 840	256 x 840 x 840	256 x 840 x 840	256 x 840 x 840	319 x 840 x 840	319 x 840 x 840	319 x 840 x 840
	Panel (H x W x D)	mm	33,5 x 950 x 950	33,5 x 950 x 950	33,5 x 950 x 950	33,5 x 950 x 950	33,5 x 950 x 950	33,5 x 950 x 950	33,5 x 950 x 950
Net weight	Indoor / Panel	kg	19/5	19/5	20/5	20/5	25/5	25/5	25/5
nanoe X Generator			Mark 1	Mark 1	Mark 1	Mark 1	Mark 1	Mark 1	Mark 1
<b>Outdoor unit</b>			<b>U-36PZH3E5</b>	<b>U-50PZH3E5</b>	<b>U-60PZH3E5</b>	<b>U-71PZH4E5</b>	<b>U-100PZH4E5</b>	<b>U-125PZH4E5</b>	<b>U-140PZH4E5</b>
Power supply		V	220 - 230 - 240	220 - 230 - 240	220 - 230 - 240	220 - 230 - 240	220 - 230 - 240	220 - 230 - 240	220 - 230 - 240
Current	Cool	A	3,25 - 3,10 - 3,00	5,50 - 5,25 - 5,05	6,95 - 6,65 - 6,35	8,85 - 8,45 - 8,10	10,06 - 10,02 - 9,75	16,10 - 15,40 - 14,70	18,20 - 17,40 - 16,70
	Heat	A	3,60 - 3,45 - 3,30	6,25 - 6,00 - 5,75	8,05 - 7,70 - 7,40	9,40 - 9,00 - 8,60	10,90 - 10,60 - 10,10	14,90 - 14,20 - 13,60	18,20 - 17,40 - 16,70
Air flow	Cool / Heat	m <sup>3</sup> /min	34,1/36,4	42,0/42,0	42,0/42,0	62,0/66,0	76,0/70,0	86,0/78,0	89,0/83,0
Sound pressure	Cool / Heat (Hi)	dB(A)	43/44	46/48	47/50	48/50	52/52	55/55	56/56
Sound power	Cool / Heat (Hi)	dB(A)	62/64	64/67	65/69	65/67	69/69	73/73	74/74
Dimension	H x W x D	mm	695 x 875 x 320	695 x 875 x 320	695 x 875 x 320	996 x 980 x 370	996 x 980 x 370	996 x 980 x 370	996 x 980 x 370
Net weight		kg	42	42	43	66	84	86	86
Piping diameter	Liquid	Inch (mm)	1/4 (6,35)	1/4 (6,35)	1/4 (6,35) <sup>6)</sup>	3/8 (9,52)	3/8 (9,52)	3/8 (9,52)	3/8 (9,52)
	Gas	Inch (mm)	1/2 (12,70)	1/2 (12,70)	1/2 (12,70) <sup>7)</sup>	5/8 (15,88)	5/8 (15,88)	5/8 (15,88)	5/8 (15,88)
Pipe length range		m	3 - 40	3 - 40	3 - 40	5 - 60	5 - 100	5 - 100	5 - 100
Elevation difference (in / out) <sup>8)</sup>		m	15/30	15/30	15/30	15/30	15/30	15/30	15/30
Pre-charged pipe length		m	30	30	30	30	30	30	30
Additional gas amount		g/m	15	15	15	30	40	40	40
Refrigerant (R32) / CO <sub>2</sub> Eq.		kg / T	1,13/0,76	1,13/0,76	1,15/0,78	1,95/1,32	2,70/1,82	3,00/2,03	3,00/2,03
Operating range	Cool Min ~ Max	°C	-15 ~ +46	-15 ~ +46	-15 ~ +46	-15 ~ +52	-20 <sup>9)</sup> ~ +52	-20 <sup>9)</sup> ~ +52	-20 <sup>9)</sup> ~ +52
	Heat Min ~ Max	°C	-20 ~ +24	-20 ~ +24	-20 ~ +24	-20 ~ +24	-20 ~ +24	-20 ~ +24	-20 ~ +24

## Technical focus

- High performance turbo fan
- Econavi: An optional intelligent sensor to reduce waste of energy
- nanoe™ X (Generator Mark 1: 4,8 trillion hydroxyl radicals/sec) as standard for better indoor air quality, indoor unit internal cleaning with nanoe™ X plus dry operation
- **New** graphite black and white panels providing options to suit a variety of light commercial applications
- Lower noise in low fan operation
- Light weight, easy piping and integrated drain pump for quick installation
- Wired remote control CZ-RTC6WBL and CZ-RTC6BL allows easy system setting via Bluetooth®
- High volume fresh air input with optional air-intake plenum and chamber (CZ-FDU3+CZ-ATU2)

## White and graphite black panels available for the 4 way 90x90 cassette.

## Standard panel, white (RAL9003).

CZ-KPU3



## Econavi panel, white (RAL9003).

CZ-KPU3A



## Standard panel, graphite black (RAL9011).

CZ-KPU3B

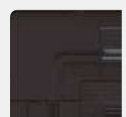



COMPATIBLE WITH ALL PANASONIC CONNECTIVITY SOLUTIONS. FOR DETAILED INFORMATION GO TO THE CONTROL SYSTEMS SECTION

Optional:



Three phase

			7,1 kW	10,0 kW	12,5 kW	14,0 kW
Kit			KIT-71PU3ZH48	KIT-100PU3ZH48	KIT-125PU3ZH48	KIT-140PU3ZH48
Remote controller			CZ-RTC5B	CZ-RTC5B	CZ-RTC5B	CZ-RTC5B
Cooling capacity	Nominal (Min - Max)	kW	7,1 [2,2 - 9,0]	9,5 [3,1 - 12,5]	12,5 [3,2 - 14,0]	13,4 [3,3 - 16,0]
EER <sup>1)</sup>	Nominal (Min - Max)	W/W	4,06 [2,69 - 5,79]	4,42 [3,42 - 5,34]	3,80 [3,08 - 5,33]	3,60 [2,74 - 5,32]
<b>SEER / η<sub>s,c</sub> <sup>2)</sup></b>			<b>7,7 A++</b>	<b>7,2 A++</b>	<b>303,0%</b>	<b>286,6%</b>
Pdesign		kW	7,1	9,5	12,5	13,4
Input power	Nominal (Min - Max)	kW	1,75 [0,38 - 3,35]	2,15 [0,58 - 3,65]	3,29 [0,60 - 4,55]	3,72 [0,62 - 5,85]
Annual energy consumption <sup>3)</sup>		kWh/a	323	426	—	—
Heating capacity	Nominal (Min - Max)	kW	8,0 [2,0 - 9,0]	11,2 [3,1 - 14,0]	14,0 [3,2 - 16,0]	16,0 [3,3 - 18,0]
Heating capacity at -15 °C <sup>4)</sup>	Max	kW	7,5	11,9	13,4	15,0
COP <sup>1)</sup>	Nominal (Min - Max)	W/W	4,30 [3,16 - 5,56]	5,00 [3,64 - 5,54]	4,61 [3,37 - 5,52]	4,30 [3,27 - 5,50]
<b>SCOP / η<sub>s,h</sub> <sup>2)</sup></b>			<b>4,8 A++</b>	<b>4,9 A++</b>	<b>186,0%</b>	<b>181,1%</b>
Pdesign at -10 °C		kW	5,2	8,0	9,5	10,6
Input power	Nominal (Min - Max)	kW	1,86 [0,36 - 2,85]	2,24 [0,56 - 3,85]	3,04 [0,58 - 4,75]	3,72 [0,60 - 5,50]
Annual energy consumption <sup>3)</sup>		kWh/a	1517	2286	—	—
<b>Indoor unit</b>			<b>S-6071PU3E</b>	<b>S-1014PU3E</b>	<b>S-1014PU3E</b>	<b>S-1014PU3E</b>
Air flow	Hi / Med / Lo	m <sup>3</sup> /min	22,0/16,0/13,0	36,0/26,0/18,0	37,0/27,0/19,0	38,0/29,0/20,0
Moisture removal volume		L/h	2,5	1,9	4,8	4,9
Sound pressure <sup>5)</sup>	Hi / Med / Lo	dB(A)	37/31/28	45/38/32	46/39/33	47/40/34
Sound power	Hi / Med / Lo	dB(A)	52/46/43	60/53/47	61/54/48	62/55/49
Dimension	Indoor (HxWxD)	mm	256 x 840 x 840	319 x 840 x 840	319 x 840 x 840	319 x 840 x 840
	Panel (HxWxD)	mm	33,5 x 950 x 950	33,5 x 950 x 950	33,5 x 950 x 950	33,5 x 950 x 950
Net weight	Indoor / Panel	kg	20/5	25/5	25/5	25/5
nanoe X Generator			Mark 1	Mark 1	Mark 1	Mark 1
<b>Outdoor unit</b>			<b>U-71PZH4E8</b>	<b>U-100PZH4E8</b>	<b>U-125PZH4E8</b>	<b>U-140PZH4E8</b>
Power supply		V	380 - 400 - 415	380 - 400 - 415	380 - 400 - 415	380 - 400 - 415
Current	Cool	A	2,95 - 2,80 - 2,70	3,60 - 3,40 - 3,25	5,45 - 5,15 - 5,00	6,15 - 5,85 - 5,65
	Heat	A	3,15 - 3,00 - 2,90	3,75 - 3,55 - 3,40	5,10 - 4,80 - 4,65	6,20 - 5,90 - 5,65
Air flow	Cool / Heat	m <sup>3</sup> /min	62,0/66,0	76,0/70,0	86,0/78,0	89,0/83,0
Sound pressure	Cool / Heat (Hi)	dB(A)	48/50	52/52	55/55	56/56
Sound power	Cool / Heat (Hi)	dB(A)	65/67	69/69	73/73	74/74
Dimension	HxWxD	mm	996 x 980 x 370	996 x 980 x 370	996 x 980 x 370	996 x 980 x 370
Net weight		kg	66	82	84	84
Piping diameter	Liquid	Inch (mm)	3/8 (9,52)	3/8 (9,52)	3/8 (9,52)	3/8 (9,52)
	Gas	Inch (mm)	5/8 (15,88)	5/8 (15,88)	5/8 (15,88)	5/8 (15,88)
Pipe length range		m	5 - 60	5 - 100	5 - 100	5 - 100
Elevation difference (in / out) <sup>8)</sup>		m	15/30	15/30	15/30	15/30
Pre-charged pipe length		m	30	30	30	30
Additional gas amount		g/m	30	40	40	40
Refrigerant (R32) / CO <sub>2</sub> Eq.		kg / T	1,95/1,32	2,70/1,82	3,00/2,03	3,00/2,03
Operating range	Cool Min ~ Max	°C	-15 ~ +52	-20 <sup>9)</sup> ~ +52	-20 <sup>9)</sup> ~ +52	-20 <sup>9)</sup> ~ +52
	Heat Min ~ Max	°C	-20 ~ +24	-20 ~ +24	-20 ~ +24	-20 ~ +24

1) EER and COP calculation is based in accordance to EN 14511. 2) For models below 12 kW, the SEER and SCOP is calculated based on values of EU/626/2011. For models above 12 kW, the η<sub>s,c</sub> / η<sub>s,h</sub> values is calculated based on EN 14825. 3) Factory setting. 4) The value is based on the interpolation. 5) The sound pressure of the units shows the value measured of the position 1,5 m below the unit. The sound pressure is measured in accordance with Eurovent 6/C/006-97 specification. 6) Connect the liquid socket tube (Ø6,35-Ø9,52) to the liquid tubing side indoor unit. 7) Connect the gas socket tube (Ø12,70-Ø15,88) to the gas tubing side indoor unit. 8) Outdoor unit located lower / outdoor unit located higher. 9) Pipe length up to 30 m. \* Recommended fuse for the indoor 3 A. \*\* Above values are in the case of nanoe™ X OFF.

Accessories

<b>CZ-RTC6W</b>	CONEX wired remote controller (non-wireless), white
<b>CZ-RTC6WBL</b>	CONEX wired remote controller with Bluetooth®, white
<b>CZ-RTC6WBLW2</b>	CONEX wired remote controller with Wi-Fi and Bluetooth®, white
<b>CZ-RTC6</b>	CONEX wired remote controller (non-wireless), black
<b>CZ-RTC6BL</b>	CONEX wired remote controller with Bluetooth®, black
<b>CZ-RTC6BLW2</b>	CONEX wired remote controller with Wi-Fi and Bluetooth®, black
<b>CZ-RTC5B</b>	Wired remote controller with Econavi function
<b>CZ-RWS3 + CZ-RWRU3</b>	Infrared remote controller and receiver
<b>CZ-CAPWFC2</b>	Commercial Wi-Fi Adaptor

Accessories

<b>CZ-KPU3A</b>	Econavi exclusive panel, white (RAL9003)
<b>CZ-KPU3B</b>	<b>NEW</b> Standard panel, graphite black (RAL9011)
<b>PAW-PACR4</b>	Interface to run up to 4 indoor unit groups on backup and alternative run
<b>PAW-WTRAY</b>	Tray for condenser water compatible with outdoor elevation platform
<b>PAW-GRDBSE20</b>	Outdoor base ground support for noise and vibration absorption
<b>PAW-GRDSTD40</b>	Outdoor elevation platform 400 x 900 x 400 mm
<b>CZ-FDU3+CZ-ATU2</b>	Fresh air-intake kit



SEER and SCOP: For S-3650PU3E + U-36PZH3E5. ECONAVI and INTERNET CONTROL: Optional.

Rating conditions: Cooling indoor 27 °C DB / 19 °C WB. Cooling outdoor 35 °C DB / 24 °C WB. Heating indoor 20 °C DB. Heating outdoor 7 °C DB / 6 °C WB. (DB: Dry Bulb; WB: Wet Bulb). Specifications subject to change without notice. For detailed information about ErP / Energy Labelling, please visit our websites www.aircon.panasonic.eu or www.ptc.panasonic.eu.

## PACi NX Series Standard 4 way 90x90 cassette - PU3 · R32

## 4 way 90x90 cassette - PU3.

Powerful turbo fan and intelligent Econavi sensor ensure high energy efficiency, and nanoe™ X, which is equipped as standard, provides an exceptional level of indoor air quality.



			Single phase						
			3,6 kW	5,0 kW	6,0 kW	7,1 kW	10,0 kW	12,5 kW	14,0 kW
Kit			KIT-36PU3Z5	KIT-50PU3Z5	KIT-60PU3Z5	KIT-71PU3Z5	KIT-100PU3Z5	KIT-125PU3Z5	KIT-140PU3Z5
Remote controller			CZ-RTC5B	CZ-RTC5B	CZ-RTC5B	CZ-RTC5B	CZ-RTC5B	CZ-RTC5B	CZ-RTC5B
Cooling capacity	Nom (Min - Max)	kW	3,6(1,5 - 4,0)	5,0(1,5 - 5,6)	6,0(2,0 - 7,1)	7,1(2,6 - 7,7)	10,0(3,0 - 11,5)	12,5(3,2 - 13,5)	14,0(3,3 - 15,0)
EER <sup>1)</sup>	Nom (Min - Max)	W/W	4,34(5,88-3,81)	3,91(6,25-3,20)	3,73(6,90-3,01)	3,27(5,00-2,77)	3,82(2,88 - 5,36)	3,58(2,81 - 5,33)	3,23(2,73 - 5,32)
SEER / η <sub>s,c</sub> <sup>2)</sup>			8,1 A++	8,0 A++	7,8 A++	6,8 A++	6,8 A++	267,0%	257,0%
Pdesign		kW	3,6	5,0	6,0	7,1	10,0	12,5	14,0
Input power	Nom (Min - Max)	kW	0,83(0,25-1,05)	1,28(0,24-1,75)	1,61(0,29-2,36)	2,17(0,52-2,78)	2,62(0,56 - 4,00)	3,49(0,60 - 4,80)	4,34(0,62 - 5,50)
Annual energy consumption <sup>3)</sup>		kWh/a	156	219	269	365	515	—	—
Heating capacity	Nom (Min - Max)	kW	3,6(1,5 - 4,6)	5,0(1,5 - 6,4)	6,0(1,8 - 7,0)	7,1(2,1 - 8,1)	10,0(3,0 - 14,0)	12,5(3,3 - 15,0)	14,0(3,4 - 16,0)
Heating capacity at -15 °C <sup>4)</sup>	Max	kW	2,7	3,7	4,7	4,8	8,2	10,5	10,8
COP <sup>1)</sup>	Nom (Min - Max)	W/W	5,07(4,32 - 6,52)	4,63(3,48 - 7,50)	4,48(3,18 - 7,50)	4,23(3,38 - 6,36)	4,93(3,59 - 5,36)	4,43(3,57 - 5,50)	4,18(3,33 - 5,48)
SCOP / η <sub>s,h</sub> <sup>2)</sup>			4,8 A++	4,7 A++	4,9 A++	4,6 A++	4,4 A+	157,0%	152,2%
Pdesign at -10 °C		kW	2,8	4,0	4,6	5,2	10,0	12,5	14,0 (at -7 °C)
Input power	Nom (Min - Max)	kW	0,71(0,23-1,06)	1,08(0,20-1,84)	1,34(0,24-2,20)	1,68(0,33-2,40)	2,03(0,56 - 3,90)	2,82(0,60 - 4,20)	3,35(0,62 - 4,80)
Annual energy consumption <sup>3)</sup>		kWh/a	817	1191	1314	1583	3182	—	—
<b>Indoor unit</b>			<b>S-3650PU3E</b>	<b>S-3650PU3E</b>	<b>S-6071PU3E</b>	<b>S-6071PU3E</b>	<b>S-1014PU3E</b>	<b>S-1014PU3E</b>	<b>S-1014PU3E</b>
Air flow	Hi / Med / Lo	m <sup>3</sup> /min	14,5/13,0/11,5	16,5/13,5/11,5	21,0/16,0/13,0	22,0/16,0/13,0	36,0/26,0/18,0	37,0/27,0/19,0	38,0/29,0/20,0
Moisture removal volume		L/h	0,7	1,6	1,7	2,5	2,7	4,8	6,0
Sound pressure <sup>5)</sup>	Hi / Med / Lo	dB(A)	30/28/27	32/29/27	36/31/28	37/31/28	45/38/32	46/39/33	47/40/34
Sound power	Hi / Med / Lo	dB(A)	45/43/42	47/44/42	51/46/43	52/46/43	60/53/47	61/54/48	62/55/49
Dimension	Indoor (H x W x D)	mm	256 x 840 x 840	256 x 840 x 840	256 x 840 x 840	256 x 840 x 840	319 x 840 x 840	319 x 840 x 840	319 x 840 x 840
	Panel (H x W x D)	mm	33,5 x 950 x 950	33,5 x 950 x 950	33,5 x 950 x 950	33,5 x 950 x 950	33,5 x 950 x 950	33,5 x 950 x 950	33,5 x 950 x 950
Net weight	Indoor / Panel	kg	19/5	19/5	20/5	20/5	25/5	25/5	25/5
nanoe X Generator			Mark 1	Mark 1	Mark 1	Mark 1	Mark 1	Mark 1	Mark 1
<b>Outdoor unit</b>			<b>U-36PZ3E5</b>	<b>U-50PZ3E5</b>	<b>U-60PZ3E5A</b>	<b>U-71PZ3E5A</b>	<b>U-100PZ3E5</b>	<b>U-125PZ3E5</b>	<b>U-140PZ3E5</b>
Power supply		V	220 - 230 - 240	220 - 230 - 240	220 - 230 - 240	220 - 230 - 240	220 - 230 - 240	220 - 230 - 240	220 - 230 - 240
Current	Cool	A	3,85 - 3,70 - 3,55	5,95 - 5,70 - 5,45	7,45 - 7,15 - 6,85	10,00 - 9,65 - 9,25	13,10 - 12,50 - 12,00	16,90 - 16,10 - 15,40	21,00 - 20,00 - 19,20
	Heat	A	3,35 - 3,20 - 3,05	5,05 - 4,85 - 4,65	6,20 - 5,95 - 5,70	7,80 - 7,45 - 7,15	10,10 - 9,70 - 9,30	13,60 - 13,00 - 12,50	16,20 - 15,50 - 14,80
Air flow	Cool / Heat	m <sup>3</sup> /min	33,6/34,0	32,7/31,9	42,6/41,5	44,7/45,9	73,0/73,0	82,0/80,0	84,0/82,0
Sound pressure	Cool / Heat (Hi)	dB(A)	46/47	46/46	47/48	48/49	52/52	55/55	56/56
Sound power	Cool / Heat (Hi)	dB(A)	64/66	64/64	64/65	66/68	70/70	73/73	74/74
Dimension	H x W x D	mm	619 x 824 x 299	619 x 824 x 299	695 x 875 x 320	695 x 875 x 320	996 x 980 x 370	996 x 980 x 370	996 x 980 x 370
Net weight		kg	32	35	42	50	83	87	87
Piping diameter	Liquid	Inch (mm)	1/4 (6,35)	1/4 (6,35)	1/4 (6,35) <sup>6)</sup>	1/4 (6,35) <sup>6)</sup>	3/8 (9,52)	3/8 (9,52)	3/8 (9,52)
	Gas	Inch (mm)	1/2 (12,70)	1/2 (12,70)	1/2 (12,70) <sup>7)</sup>	5/8 (15,88)	5/8 (15,88)	5/8 (15,88)	5/8 (15,88)
Pipe length range		m	3 - 15	3 - 20	3 - 40	3 - 40	5 - 50	5 - 50	5 - 50
Elevation difference (in / out) <sup>8)</sup>		m	15/15	15/15	15/30	20/30	15/30	15/30	15/30
Pre-charged pipe length		m	7,5	7,5	30	30	30	30	30
Additional gas amount		g/m	10	15	15	17	45	45	45
Refrigerant (R32) / CO <sub>2</sub> Eq.		kg / T	0,87/0,59	1,14/0,77	1,15/0,78	1,32/0,89	2,40/1,62	2,80/1,89	2,80/1,89
Operating range	Cool Min ~ Max	°C	-10 ~ +43	-10 ~ +43	-10 ~ +43	-10 ~ +43	-10 ~ +43	-10 ~ +43	-10 ~ +43
	Heat Min ~ Max	°C	-15 ~ +24	-15 ~ +24	-15 ~ +24	-15 ~ +24	-15 ~ +24	-15 ~ +24	-15 ~ +24

## Technical focus

- High performance turbo fan
- Econavi: An optional intelligent sensor to reduce waste of energy
- nanoe™ X (Generator Mark 1: 4,8 trillion hydroxyl radicals/sec) as standard for better indoor air quality, indoor unit internal cleaning with nanoe™ X plus dry operation
- **New** graphite black and white panels providing options to suit a variety of light commercial applications
- Lower noise in low fan operation
- Light weight, easy piping and integrated drain pump for quick installation
- Wired remote control CZ-RTC6WBL and CZ-RTC6BL allows easy system setting via Bluetooth®
- High volume fresh air input with optional air-intake plenum and chamber (CZ-FDU3+CZ-ATU2)

## White and graphite black panels available for the 4 way 90x90 cassette.

## Standard panel, white (RAL9003).

CZ-KPU3



## Econavi panel, white (RAL9003).

CZ-KPU3A



## Standard panel, graphite black (RAL9011).

CZ-KPU3B

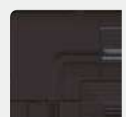



CZ-RTC5B



COMPATIBLE WITH ALL PANASONIC CONNECTIVITY SOLUTIONS. FOR DETAILED INFORMATION GO TO THE CONTROL SYSTEMS SECTION

Optional:



CONEX wired remote controller, white. CZ-RTC6W/BL/BLW2



CONEX wired remote controller, black. CZ-RTC6/BL/BLW2



Infrared remote controller. CZ-RWS3 + CZ-RWRU3

			Three phase		
			10,0 kW	12,5 kW	14,0 kW
Kit			KIT-100PU3Z8	KIT-125PU3Z8	KIT-140PU3Z8
Remote controller			CZ-RTC5B	CZ-RTC5B	CZ-RTC5B
Cooling capacity	Nominal (Min - Max)	kW	10,0 (3,0 - 11,5)	12,5 (3,2 - 13,5)	14,0 (3,3 - 15,0)
EER <sup>1)</sup>	Nominal (Min - Max)	W/W	3,82 (2,88 - 5,36)	3,58 (2,81 - 5,33)	3,23 (2,73 - 5,32)
SEER / η <sub>s,c</sub> <sup>2)</sup>			6,7 A++	265,8%	256,2%
Pdesign		kW	10,0	12,5	14,0
Input power	Nominal (Min - Max)	kW	2,62 (0,56 - 4,00)	3,49 (0,60 - 4,80)	4,34 (0,62 - 5,50)
Annual energy consumption <sup>3)</sup>		kWh/a	521	—	—
Heating capacity	Nominal (Min - Max)	kW	10,0 (3,0 - 14,0)	12,5 (3,3 - 15,0)	14,0 (3,4 - 16,0)
Heating capacity at -15 °C <sup>4)</sup>	Max	kW	8,2	10,5	10,8
COP <sup>1)</sup>	Nominal (Min - Max)	W/W	4,93 (3,59 - 5,36)	4,43 (3,57 - 5,50)	4,18 (3,33 - 5,48)
SCOP / η <sub>s,h</sub> <sup>2)</sup>			4,4 A+	157,0%	152,2%
Pdesign at -10 °C		kW	10,0	12,5	14,0 (at -7 °C)
Input power	Nominal (Min - Max)	kW	2,03 (0,56 - 3,90)	2,82 (0,60 - 4,20)	3,35 (0,62 - 4,80)
Annual energy consumption <sup>3)</sup>		kWh/a	3182	—	—
Indoor unit			S-1014PU3E	S-1014PU3E	S-1014PU3E
Air flow	Hi / Med / Lo	m <sup>3</sup> /min	36,0/26,0/18,0	37,0/27,0/19,0	38,0/29,0/20,0
Moisture removal volume		L/h	2,7	4,8	6,0
Sound pressure <sup>5)</sup>	Hi / Med / Lo	dB(A)	45/38/32	46/39/33	47/40/34
Sound power	Hi / Med / Lo	dB(A)	60/53/47	61/54/48	62/55/49
Dimension	Indoor (HxWxD)	mm	319 x 840 x 840	319 x 840 x 840	319 x 840 x 840
	Panel (HxWxD)	mm	33,5 x 950 x 950	33,5 x 950 x 950	33,5 x 950 x 950
Net weight	Indoor / Panel	kg	25/5	25/5	25/5
nanoe X Generator			Mark 1	Mark 1	Mark 1
Outdoor unit			U-100PZ3E8	U-125PZ3E8	U-140PZ3E8
Power supply		V	380 - 400 - 415	380 - 400 - 415	380 - 400 - 415
Current	Cool	A	4,35 - 4,15 - 4,00	5,65 - 5,35 - 5,15	7,00 - 6,65 - 6,40
	Heat	A	3,40 - 3,20 - 3,10	4,55 - 4,35 - 4,15	5,40 - 5,15 - 4,95
Air flow	Cool / Heat	m <sup>3</sup> /min	73,0/73,0	82,0/80,0	84,0/82,0
Sound pressure	Cool / Heat (Hi)	dB(A)	52/52	55/55	56/56
Sound power	Cool / Heat (Hi)	dB(A)	70/70	73/73	74/74
Dimension	HxWxD	mm	996x980x370	996x980x370	996x980x370
Net weight		kg	83	87	87
Piping diameter	Liquid	Inch (mm)	3/8(9,52)	3/8(9,52)	3/8(9,52)
	Gas	Inch (mm)	5/8(15,88)	5/8(15,88)	5/8(15,88)
Pipe length range		m	5 - 50	5 - 50	5 - 50
Elevation difference (in / out) <sup>8)</sup>		m	15/30	15/30	15/30
Pre-charged pipe length		m	30	30	30
Additional gas amount		g/m	45	45	45
Refrigerant (R32) / CO <sub>2</sub> Eq.		kg / T	2,40/1,62	2,80/1,89	2,80/1,89
Operating range	Cool Min ~ Max	°C	-10 ~ +43	-10 ~ +43	-10 ~ +43
	Heat Min ~ Max	°C	-15 ~ +24	-15 ~ +24	-15 ~ +24

1) EER and COP calculation is based in accordance to EN 14511. 2) For models below 12 kW, the SEER and SCOP is calculated based on values of EU/626/2011. For models above 12 kW, the η<sub>s,c</sub> / η<sub>s,h</sub> values is calculated based on EN 14825. 3) Factory setting. 4) The value is based on the interpolation. 5) The sound pressure of the units shows the value measured of the position 1,5 m below the unit. The sound pressure is measured in accordance with Eurovent 6/C/006-97 specification. 6) Connect the liquid socket tube (Ø6,35-Ø9,52) to the liquid tubing side indoor unit. 7) Connect the gas socket tube (Ø12,70-Ø15,88) to the gas tubing side indoor unit. 8) Outdoor unit located lower / outdoor unit located higher. \* Recommended fuse for the indoor 3 A. \*\* Above values are in the case of nanoe™ X OFF.

Accessories

CZ-RTC6W	CONEX wired remote controller (non-wireless), white
CZ-RTC6WBL	CONEX wired remote controller with Bluetooth®, white
CZ-RTC6WBLW2	CONEX wired remote controller with Wi-Fi and Bluetooth®, white
CZ-RTC6	CONEX wired remote controller (non-wireless), black
CZ-RTC6BL	CONEX wired remote controller with Bluetooth®, black
CZ-RTC6BLW2	CONEX wired remote controller with Wi-Fi and Bluetooth®, black
CZ-RTC5B	Wired remote controller with Econavi function
CZ-RWS3 + CZ-RWRU3	Infrared remote controller and receiver
CZ-CAPWFC2	Commercial Wi-Fi Adaptor

Accessories

CZ-KPU3A	Econavi exclusive panel, white (RAL9003)
CZ-KPU3B	NEW Standard panel, graphite black (RAL9011)
PAW-PACR4	Interface to run up to 4 indoor unit groups on backup and alternative run
PAW-WTRAY	Tray for condenser water compatible with outdoor elevation platform
PAW-GRDBSE20	Outdoor base ground support for noise and vibration absorption
PAW-GRDSTD40	Outdoor elevation platform 400x900x400 mm
CZ-FDU3+CZ-ATU2	Fresh air-intake kit



SEER: For S-3650PU3E + U-36PZ3E5. SCOP: For S-6071PU3E + U-60PZ3E5A. ECONAVI and INTERNET CONTROL: Optional.

Rating conditions: Cooling indoor 27 °C DB / 19 °C WB. Cooling outdoor 35 °C DB / 24 °C WB. Heating indoor 20 °C DB. Heating outdoor 7 °C DB / 6 °C WB. (DB: Dry Bulb; WB: Wet Bulb). Specifications subject to change without notice. For detailed information about ErP / Energy Labelling, please visit our websites www.aircon.panasonic.eu or www.ptc.panasonic.eu.

## PACi NX Series Elite ceiling - PT3 · R32

Ceiling mounted units provide large and wide air distribution which is ideal for large rooms.

The height and depth of all capacities are the same for unified appearance in mixed installations.



			Single phase						
			3,6 kW	5,0 kW	6,0 kW	7,1 kW	10,0 kW	12,5 kW	14,0 kW
Kit			KIT-36PT3ZH5	KIT-50PT3ZH5	KIT-60PT3ZH5	KIT-71PT3ZH45	KIT-100PT3ZH45	KIT-125PT3ZH45	KIT-140PT3ZH45
Remote controller			CZ-RTC5B	CZ-RTC5B	CZ-RTC5B	CZ-RTC5B	CZ-RTC5B	CZ-RTC5B	CZ-RTC5B
Cooling capacity	Nom (Min - Max)	kW	3,5(1,2 - 4,0)	5,0(1,2 - 5,6)	6,0(1,2 - 7,1)	6,8(2,2 - 9,0)	9,5(3,1 - 12,5)	12,1(3,2 - 14,0)	13,4(3,3 - 16,0)
EER <sup>1)</sup>	Nom (Min - Max)	W/W	4,86(4,55 - 5,45)	4,03(3,57 - 5,45)	3,82(3,02 - 5,45)	3,91(2,69 - 5,79)	4,06(3,29 - 5,34)	3,46(3,01 - 5,33)	3,21(2,67 - 5,32)
SEER / η <sub>s,c</sub> <sup>2)</sup>			<b>7,7 A++</b>	<b>7,4 A++</b>	<b>7,5 A++</b>	<b>7,3 A++</b>	<b>7,3 A++</b>	<b>278,4%</b>	<b>263,3%</b>
Pdesign		kW	3,5	5,0	6,0	6,8	9,5	12,1	13,4
Input power	Nom (Min - Max)	kW	0,72(0,22 - 0,88)	1,24(0,22 - 1,57)	1,57(0,22 - 2,35)	1,74(0,38 - 3,35)	2,34(0,58 - 3,80)	3,50(0,60 - 4,65)	4,17(0,62 - 6,00)
Annual energy consumption <sup>3)</sup>		kWh/a	160	237	280	326	456	—	—
Heating capacity	Nom (Min - Max)	kW	4,0(1,2 - 5,0)	5,6(1,2 - 6,5)	7,0(1,2 - 8,0)	8,0(2,0 - 9,0)	11,2(3,1 - 14,0)	14,0(3,2 - 16,0)	16,0(3,3 - 18,0)
Heating capacity at -15 °C <sup>4)</sup>	Max	kW	3,2	4,1	5,1	7,5	11,9	13,4	15,0
COP <sup>1)</sup>	Nom (Min - Max)	W/W	5,00(4,17 - 5,45)	4,03(3,94 - 5,45)	4,14(3,40 - 5,45)	3,96(3,16 - 5,56)	4,00(3,54 - 5,54)	3,78(3,20 - 5,52)	3,38(3,10 - 5,50)
SCOP / η <sub>s,h</sub> <sup>2)</sup>			<b>4,9 A++</b>	<b>4,8 A++</b>	<b>4,8 A++</b>	<b>4,7 A++</b>	<b>4,5 A+</b>	<b>175,6%</b>	<b>169,3%</b>
Pdesign at -10 °C		kW	3,1	4,0	4,6	4,7	7,8	9,5	10,2
Input power	Nom (Min - Max)	kW	0,80(0,22 - 1,20)	1,39(0,22 - 1,65)	1,69(0,22 - 2,35)	2,02(0,36 - 2,85)	2,80(0,56 - 3,95)	3,70(0,58 - 5,00)	4,74(0,60 - 5,80)
Annual energy consumption <sup>3)</sup>		kWh/a	886	1167	1342	1400	2426	—	—
<b>Indoor unit</b>			<b>S-3650PT3E</b>	<b>S-3650PT3E</b>	<b>S-6071PT3E</b>	<b>S-6071PT3E</b>	<b>S-1014PT3E</b>	<b>S-1014PT3E</b>	<b>S-1014PT3E</b>
Air flow	Hi / Med / Lo	m <sup>3</sup> /min	14,0/12,0/10,5	15,0/12,5/10,5	20,0/17,0/14,5	21,0/18,0/15,5	30,0/25,0/23,0	34,0/28,0/24,0	35,0/29,0/25,0
Moisture removal volume		L/h	0,8	2,0	2,1	2,7	3,6	5,4	6,4
Sound pressure <sup>5)</sup>	Hi / Med / Lo	dB(A)	36/32/28	37/33/28	38/34/29	39/35/30	42/37/34	46/40/35	47/41/36
Sound power	Hi / Med / Lo	dB(A)	54/50/46	55/51/46	56/52/47	57/53/48	60/55/52	64/58/53	65/59/54
Dimension	H x W x D	mm	235 x 960 x 690	235 x 960 x 690	235 x 1275 x 690	235 x 1275 x 690	235 x 1590 x 690	235 x 1590 x 690	235 x 1590 x 690
Net weight		kg	26	26	34	34	40	40	40
nanoe X Generator			Mark 2	Mark 2	Mark 2	Mark 2	Mark 2	Mark 2	Mark 2
<b>Outdoor unit</b>			<b>U-36PZH3E5</b>	<b>U-50PZH3E5</b>	<b>U-60PZH3E5</b>	<b>U-71PZH4E5</b>	<b>U-100PZH4E5</b>	<b>U-125PZH4E5</b>	<b>U-140PZH4E5</b>
Power supply		V	220 - 230 - 240	220 - 230 - 240	220 - 230 - 240	220 - 230 - 240	220 - 230 - 240	220 - 230 - 240	220 - 230 - 240
Current	Cool	A	3,55 - 3,40 - 3,25	5,85 - 5,60 - 5,40	7,35 - 7,05 - 6,75	8,80 - 8,40 - 8,05	11,60 - 11,10 - 10,60	17,10 - 16,40 - 15,70	20,40 - 19,50 - 18,70
	Heat	A	3,90 - 3,75 - 3,60	6,60 - 6,30 - 6,05	7,85 - 7,50 - 7,20	10,20 - 9,75 - 9,35	13,70 - 13,20 - 12,70	18,10 - 17,30 - 16,60	23,20 - 22,20 - 21,20
Air flow	Cool / Heat	m <sup>3</sup> /min	34,1/36,4	42,0/42,0	42,0/42,0	62,0/66,0	76,0/70,0	86,0/78,0	89,0/83,0
Sound pressure	Cool / Heat (Hi)	dB(A)	43/44	46/48	47/50	48/50	52/52	55/55	56/56
Sound power	Cool / Heat (Hi)	dB(A)	62/64	64/67	65/69	65/67	69/69	73/73	74/74
Dimension	H x W x D	mm	695 x 875 x 320	695 x 875 x 320	695 x 875 x 320	996 x 980 x 370	996 x 980 x 370	996 x 980 x 370	996 x 980 x 370
Net weight		kg	42	42	43	66	84	86	86
Piping diameter	Liquid	Inch (mm)	1/4 (6,35)	1/4 (6,35)	1/4 (6,35) <sup>6)</sup>	3/8 (9,52)	3/8 (9,52)	3/8 (9,52)	3/8 (9,52)
	Gas	Inch (mm)	1/2 (12,70)	1/2 (12,70)	1/2 (12,70) <sup>7)</sup>	5/8 (15,88)	5/8 (15,88)	5/8 (15,88)	5/8 (15,88)
Pipe length range		m	3 - 40	3 - 40	3 - 40	5 - 60	5 - 100	5 - 100	5 - 100
Elevation difference (in / out) <sup>8)</sup>		m	15/30	15/30	15/30	15/30	15/30	15/30	15/30
Pre-charged pipe length		m	30	30	30	30	30	30	30
Additional gas amount		g/m	15	15	15	30	40	40	40
Refrigerant (R32) / CO <sub>2</sub> Eq.		kg / T	1,13/0,76	1,13/0,76	1,15/0,78	1,95/1,32	2,70/1,82	3,00/2,03	3,00/2,03
Operating range	Cool Min ~ Max	°C	-15 ~ +46	-15 ~ +46	-15 ~ +46	-15 ~ +52	-20 <sup>9)</sup> ~ +52	-20 <sup>9)</sup> ~ +52	-20 <sup>9)</sup> ~ +52
	Heat Min ~ Max	°C	-20 ~ +24	-20 ~ +24	-20 ~ +24	-20 ~ +24	-20 ~ +24	-20 ~ +24	-20 ~ +24

## Technical focus

- Wide air distribution for large rooms
- Horizontal air flow reaches maximum 9,5 m
- Fresh air connection available on the unit
- Slim design with 235 mm height fits narrow space
- Silent operation
- nanoe™ X (Generator Mark 2: 9,6 trillion hydroxyl radicals/sec) as standard for better indoor air quality
- Wired remote control CZ-RTC6WBL and CZ-RTC6BL allows easy system setting via Bluetooth®
- Twin, Triple and Double-twin split options
- Easy connection and control of external fan or ERV using the connector PAW-FDC on the indoor unit PCB. The external device can be controlled by the remote control of the Panasonic indoor unit

## Further comfort improvement with air flow distribution

Horizontal air flow reaches maximum 9,5 m. This is ideal for wide rooms.

The wide air discharge opening expands the air flow to the left and right. The unpleasant feeling caused when the air flow directly hits the human body is prevented by the "Draft prevention position", which changes the swing width, increasing the degree of comfort.

CZ-RTC5B



COMPATIBLE WITH ALL PANASONIC CONNECTIVITY SOLUTIONS. FOR DETAILED INFORMATION GO TO THE CONTROL SYSTEMS SECTION

Optional:



Three phase

			7,1 kW	10,0 kW	12,5 kW	14,0 kW
Kit			KIT-71PT3ZH48	KIT-100PT3ZH48	KIT-125PT3ZH48	KIT-140PT3ZH48
Remote controller			CZ-RTC5B	CZ-RTC5B	CZ-RTC5B	CZ-RTC5B
Cooling capacity	Nominal (Min - Max)	kW	6,8 [2,2 - 9,0]	9,5 [3,1 - 12,5]	12,1 [3,2 - 14,0]	13,4 [3,3 - 16,0]
EER <sup>1)</sup>	Nominal (Min - Max)	W/W	3,91 [2,69 - 5,79]	4,06 [3,29 - 5,34]	3,46 [3,01 - 5,33]	3,21 [2,67 - 5,32]
<b>SEER / η<sub>s,c</sub> <sup>2)</sup></b>			<b>7,2 A++</b>	<b>7,2 A++</b>	<b>277,3%</b>	<b>262,4%</b>
Pdesign		kW	6,8	9,5	12,1	13,4
Input power	Nominal (Min - Max)	kW	1,74 [0,38 - 3,35]	2,34 [0,58 - 3,80]	3,50 [0,60 - 4,65]	4,17 [0,66 - 6,00]
Annual energy consumption <sup>3)</sup>		kWh/a	331	462	—	—
Heating capacity	Nominal (Min - Max)	kW	8,0 [2,0 - 9,0]	11,2 [3,1 - 14,0]	14,0 [3,2 - 16,0]	16,0 [3,3 - 18,0]
Heating capacity at -15 °C <sup>4)</sup>	Max	kW	7,5	11,9	13,4	15,0
COP <sup>1)</sup>	Nominal (Min - Max)	W/W	3,96 [3,16 - 5,56]	4,00 [3,54 - 5,54]	3,78 [3,20 - 5,52]	3,38 [3,10 - 5,50]
<b>SCOP / η<sub>s,h</sub> <sup>2)</sup></b>			<b>4,7 A++</b>	<b>4,5 A+</b>	<b>175,6%</b>	<b>169,3%</b>
Pdesign at -10 °C		kW	4,7	7,8	9,5	10,2
Input power	Nominal (Min - Max)	kW	2,02 [0,36 - 2,85]	2,80 [0,56 - 3,95]	3,70 [0,58 - 5,00]	4,74 [0,60 - 5,80]
Annual energy consumption <sup>3)</sup>		kWh/a	1400	2427	—	—
<b>Indoor unit</b>			<b>S-6071PT3E</b>	<b>S-1014PT3E</b>	<b>S-1014PT3E</b>	<b>S-1014PT3E</b>
Air flow	Hi / Med / Lo	m <sup>3</sup> /min	21,0 / 18,0 / 15,5	30,0 / 25,0 / 23,0	34,0 / 28,0 / 24,0	35,0 / 29,0 / 25,0
Moisture removal volume		L/h	2,7	3,6	5,4	6,4
Sound pressure <sup>5)</sup>	Hi / Med / Lo	dB(A)	39 / 35 / 30	42 / 37 / 34	46 / 40 / 35	47 / 41 / 36
Sound power	Hi / Med / Lo	dB(A)	57 / 53 / 48	60 / 55 / 52	64 / 58 / 53	65 / 59 / 54
Dimension	H x W x D	mm	235 x 1275 x 690	235 x 1590 x 690	235 x 1590 x 690	235 x 1590 x 690
Net weight		kg	34	40	40	40
nanoe X Generator			Mark 2	Mark 2	Mark 2	Mark 2
<b>Outdoor unit</b>			<b>U-71PZH4E8</b>	<b>U-100PZH4E8</b>	<b>U-125PZH4E8</b>	<b>U-140PZH4E8</b>
Power supply		V	380 - 400 - 415	380 - 400 - 415	380 - 400 - 415	380 - 400 - 415
Current	Cool	A	2,95 - 2,80 - 2,70	3,60 - 3,40 - 3,25	5,45 - 5,15 - 5,00	6,15 - 5,85 - 5,65
	Heat	A	3,15 - 3,00 - 2,90	3,75 - 3,55 - 3,40	5,10 - 4,80 - 4,65	6,20 - 5,90 - 5,65
Air flow	Cool / Heat	m <sup>3</sup> /min	62,0 / 66,0	76,0 / 70,0	86,0 / 78,0	89,0 / 83,0
Sound pressure	Cool / Heat (Hi)	dB(A)	48 / 50	52 / 52	55 / 55	56 / 56
Sound power	Cool / Heat (Hi)	dB(A)	65 / 67	69 / 69	73 / 73	74 / 74
Dimension	H x W x D	mm	996 x 980 x 370	996 x 980 x 370	996 x 980 x 370	996 x 980 x 370
Net weight		kg	66	82	84	84
Piping diameter	Liquid	Inch (mm)	3/8 (9,52)	3/8 (9,52)	3/8 (9,52)	3/8 (9,52)
	Gas	Inch (mm)	5/8 (15,88)	5/8 (15,88)	5/8 (15,88)	5/8 (15,88)
Pipe length range		m	5 - 60	5 - 100	5 - 100	5 - 100
Elevation difference (in / out) <sup>8)</sup>		m	15 / 30	15 / 30	15 / 30	15 / 30
Pre-charged pipe length		m	30	30	30	30
Additional gas amount		g/m	30	40	40	40
Refrigerant (R32) / CO <sub>2</sub> Eq.		kg / T	1,95 / 1,32	2,70 / 1,82	3,00 / 2,03	3,00 / 2,03
Operating range	Cool Min ~ Max	°C	-15 ~ +52	-20 <sup>9)</sup> ~ +52	-20 <sup>9)</sup> ~ +52	-20 <sup>9)</sup> ~ +52
	Heat Min ~ Max	°C	-20 ~ +24	-20 ~ +24	-20 ~ +24	-20 ~ +24

1) EER and COP calculation is based in accordance to EN 14511. 2) For models below 12 kW, the SEER and SCOP is calculated based on values of EU/626/2011. For models above 12 kW, the η<sub>s,c</sub> / η<sub>s,h</sub> values is calculated based on EN 14825. 3) Factory setting. 4) The value is based on the interpolation. 5) The sound pressure of the units shows the value measured of the position 1 m in front of the main body and 1 m below the unit. The sound pressure is measured in accordance with Eurovent 6/C/006-97 specification. 6) Connect the liquid socket tube (Ø6,35-Ø9,52) to the liquid tubing side indoor unit. 7) Connect the gas socket tube (Ø12,70-Ø15,88) to the gas tubing side indoor unit. 8) Outdoor unit located lower / outdoor unit located higher. 9) Pipe length up to 30 m. \* Recommended fuse for the indoor 3 A. \*\* Above values are in the case of nanoe™ X OFF.

Accessories

<b>CZ-RTC6W</b>	CONEX wired remote controller (non-wireless), white
<b>CZ-RTC6WBL</b>	CONEX wired remote controller with Bluetooth®, white
<b>CZ-RTC6WBLW2</b>	CONEX wired remote controller with Wi-Fi and Bluetooth®, white
<b>CZ-RTC6</b>	CONEX wired remote controller (non-wireless), black
<b>CZ-RTC6BL</b>	CONEX wired remote controller with Bluetooth®, black
<b>CZ-RTC6BLW2</b>	CONEX wired remote controller with Wi-Fi and Bluetooth®, black
<b>CZ-RTC5B</b>	Wired remote controller with Econavi function
<b>CZ-RWS3 + CZ-RWRT3</b>	Infrared remote controller and receiver

Accessories

<b>CZ-CAPWFC2</b>	Commercial Wi-Fi Adaptor
<b>PAW-PACR4</b>	Interface to run up to 4 indoor unit groups on backup and alternative run
<b>PAW-WTRAY</b>	Tray for condenser water compatible with outdoor elevation platform
<b>PAW-GRDBSE20</b>	Outdoor base ground support for noise and vibration absorption
<b>PAW-GRDSTD40</b>	Outdoor elevation platform 400x900x400 mm
<b>CZ-CENSC1</b>	Econavi energy saving sensor



SEER and SCOP: For S-3650PT3E + U-36PZH3E5. INTERNET CONTROL: Optional.

Rating conditions: Cooling indoor 27 °C DB / 19 °C WB. Cooling outdoor 35 °C DB / 24 °C WB. Heating indoor 20 °C DB. Heating outdoor 7 °C DB / 6 °C WB. (DB: Dry Bulb, WB: Wet Bulb). Specifications subject to change without notice. For detailed information about ErP / Energy Labelling, please visit our websites www.aircon.panasonic.eu or www.ptc.panasonic.eu.

## PACi NX Series Standard ceiling - PT3 · R32

Ceiling mounted units provide large and wide air distribution which is ideal for large rooms.

The height and depth of all capacities are the same for unified appearance in mixed installations.



			Single phase							
			3,6 kW	5,0 kW	6,0 kW	7,1 kW	10,0 kW	12,5 kW	14,0 kW	
Kit			KIT-36PT3Z5	KIT-50PT3Z5	KIT-60PT3Z5	KIT-71PT3Z5	KIT-100PT3Z5	KIT-125PT3Z5	KIT-140PT3Z5	
Remote controller			CZ-RTC5B	CZ-RTC5B	CZ-RTC5B	CZ-RTC5B	CZ-RTC5B	CZ-RTC5B	CZ-RTC5B	
Cooling capacity	Nom (Min - Max)	kW	3,5(1,5 - 4,0)	5,0(1,5 - 5,2)	6,0(2,0 - 7,1)	6,8(2,6 - 7,7)	10,0(3,0 - 11,5)	12,5(3,2 - 13,5)	14,0(3,3 - 15,0)	
EER <sup>1)</sup>	Nom (Min - Max)	W/W	4,14(3,69 - 5,17)	3,03(2,86 - 5,00)	3,59(2,90 - 6,90)	3,24(2,75 - 4,91)	3,64(2,80 - 5,36)	3,32(2,77 - 5,33)	2,98(2,73 - 5,32)	
SEER / η <sub>s,c</sub> <sup>2)</sup>			<b>7,2 A++</b>	<b>6,7 A++</b>	<b>7,3 A++</b>	<b>5,9 A+</b>	<b>6,6 A++</b>	<b>241,7%</b>	<b>228,8%</b>	
Pdesign		kW	3,5	5,0	6,0	6,8	10,0	12,5	14,0	
Input power	Nom (Min - Max)	kW	0,85(0,29 - 1,10)	1,65(0,30 - 1,82)	1,67(0,29 - 2,45)	2,10(0,53 - 2,80)	2,75(0,56 - 4,10)	3,76(0,60 - 4,88)	4,70(0,62 - 5,50)	
Annual energy consumption <sup>3)</sup>		kWh/a	171	262	288	404	531	—	—	
Heating capacity	Nom (Min - Max)	kW	3,5(1,5 - 4,6)	5,0(1,5 - 6,4)	6,0(1,8 - 7,0)	6,8(2,1 - 8,1)	10,0(3,0 - 14,0)	12,5(3,3 - 15,0)	14,0(3,4 - 16,0)	
Heating capacity at -15 °C <sup>4)</sup>	Max	kW	2,7	3,7	4,7	4,8	8,2	10,5	10,8	
COP <sup>1)</sup>	Nom (Min - Max)	W/W	4,61(3,51 - 5,70)	3,73(3,12 - 6,25)	4,11(2,92 - 6,67)	4,20(3,06 - 5,68)	4,24(3,30 - 5,36)	3,89(3,41 - 4,52)	3,70(3,08 - 5,48)	
SCOP / η <sub>s,h</sub> <sup>2)</sup>			<b>4,4 A+</b>	<b>4,1 A+</b>	<b>4,6 A++</b>	<b>4,3 A+</b>	<b>4,2 A+</b>	<b>147,4%</b>	<b>145,3%</b>	
Pdesign at -10 °C		kW	2,8	4,0	4,6	4,7	10,0	12,5	13,6	
Input power	Nom (Min - Max)	kW	0,76(0,26 - 1,31)	1,34(0,24 - 2,05)	1,46(0,27 - 2,40)	1,62(0,37 - 2,65)	2,36(0,56 - 4,00)	3,21(0,73 - 4,40)	3,78(0,62 - 5,20)	
Annual energy consumption <sup>3)</sup>		kWh/a	891	1365	1399	1529	3331	—	—	
<b>Indoor unit</b>			<b>S-3650PT3E</b>	<b>S-3650PT3E</b>	<b>S-6071PT3E</b>	<b>S-6071PT3E</b>	<b>S-1014PT3E</b>	<b>S-1014PT3E</b>	<b>S-1014PT3E</b>	
Air flow	Hi / Med / Lo	m <sup>3</sup> /min	14,0/12,0/10,5	15,0/12,5/10,5	20,0/17,0/14,5	21,0/18,0/15,5	30,0/25,0/23,0	34,0/28,0/24,0	35,0/29,0/25,0	
Moisture removal volume		L/h	0,8	2,0	2,1	2,7	4,1	5,7	6,9	
Sound pressure <sup>5)</sup>	Hi / Med / Lo	dB(A)	36/32/28	37/33/28	38/34/29	39/35/30	42/37/34	46/40/35	47/41/36	
Sound power	Hi / Med / Lo	dB(A)	54/50/46	55/51/46	56/52/47	57/53/48	60/55/52	64/58/53	65/59/54	
Dimension	H x W x D	mm	235 x 960 x 690	235 x 960 x 690	235 x 1275 x 690	235 x 1275 x 690	235 x 1590 x 690	235 x 1590 x 690	235 x 1590 x 690	
Net weight		kg	26	26	34	34	40	40	40	
nanoe X Generator			Mark 2	Mark 2	Mark 2	Mark 2	Mark 2	Mark 2	Mark 2	
<b>Outdoor unit</b>			<b>U-36PZ3E5</b>	<b>U-50PZ3E5</b>	<b>U-60PZ3E5A</b>	<b>U-71PZ3E5A</b>	<b>U-100PZ3E5</b>	<b>U-125PZ3E5</b>	<b>U-140PZ3E5</b>	
Power supply		V	220 - 230 - 240	220 - 230 - 240	220 - 230 - 240	220 - 230 - 240	220 - 230 - 240	220 - 230 - 240	220 - 230 - 240	
Current	Cool	A	3,90 - 3,75 - 3,60	7,65 - 7,30 - 7,00	7,75 - 7,40 - 7,10	9,75 - 9,30 - 8,95	13,70 - 13,10 - 12,60	18,20 - 17,40 - 16,70	22,70 - 21,70 - 20,80	
	Heat	A	3,55 - 3,40 - 3,25	6,30 - 6,00 - 5,75	6,75 - 6,50 - 6,20	7,50 - 7,20 - 6,90	11,80 - 11,30 - 10,80	15,50 - 14,80 - 14,20	18,30 - 17,50 - 16,80	
Air flow	Cool / Heat	m <sup>3</sup> /min	33,6/34,0	32,7/31,9	42,6/41,5	44,7/45,9	73,0/73,0	82,0/80,0	84,0/82,0	
Sound pressure	Cool / Heat (Hi)	dB(A)	46/47	46/46	47/48	48/49	52/52	55/55	56/56	
Sound power	Cool / Heat (Hi)	dB(A)	64/66	64/64	64/65	66/68	70/70	73/73	74/74	
Dimension	H x W x D	mm	619 x 824 x 299	619 x 824 x 299	695 x 875 x 320	695 x 875 x 320	996 x 980 x 370	996 x 980 x 370	996 x 980 x 370	
Net weight		kg	32	35	42	50	83	87	87	
Piping diameter	Liquid	Inch (mm)	1/4 (6,35)	1/4 (6,35)	1/4 (6,35) <sup>6)</sup>	1/4 (6,35) <sup>6)</sup>	3/8 (9,52)	3/8 (9,52)	3/8 (9,52)	
	Gas	Inch (mm)	1/2 (12,70)	1/2 (12,70)	1/2 (12,70) <sup>7)</sup>	5/8 (15,88)	5/8 (15,88)	5/8 (15,88)	5/8 (15,88)	
Pipe length range		m	3 - 15	3 - 20	3 - 40	3 - 40	5 - 50	5 - 50	5 - 50	
Elevation difference (in / out) <sup>8)</sup>		m	15/15	15/15	15/30	20/30	15/30	15/30	15/30	
Pre-charged pipe length		m	7,5	7,5	30	30	30	30	30	
Additional gas amount		g/m	10	15	15	17	45	45	45	
Refrigerant (R32) / CO <sub>2</sub> Eq.		kg / T	0,87/0,59	1,14/0,77	1,15/0,78	1,32/0,89	2,40/1,62	2,80/1,89	2,80/1,89	
Operating range	Cool Min ~ Max	°C	-10 ~ +43	-10 ~ +43	-10 ~ +43	-10 ~ +43	-10 ~ +43	-10 ~ +43	-10 ~ +43	
	Heat Min ~ Max	°C	-15 ~ +24	-15 ~ +24	-15 ~ +24	-15 ~ +24	-15 ~ +24	-15 ~ +24	-15 ~ +24	

### Technical focus

- Wide air distribution for large rooms
- Horizontal air flow reaches maximum 9,5 m
- Fresh air connection available on the unit
- Slim design with 235 mm height fits narrow space
- Silent operation
- nanoe™ X (Generator Mark 2: 9,6 trillion hydroxyl radicals/sec) as standard for better indoor air quality
- Wired remote control CZ-RTC6WBL and CZ-RTC6BL allows easy system setting via Bluetooth®
- Single and Twin options
- Easy connection and control of external fan or ERV using the connector PAW-FDC on the indoor unit PCB. The external device can be controlled by the remote control of the Panasonic indoor unit

### Further comfort improvement with air flow distribution

Horizontal air flow reaches maximum 9,5 m. This is ideal for wide rooms.

The wide air discharge opening expands the air flow to the left and right. The unpleasant feeling caused when the air flow directly hits the human body is prevented by the "Draft prevention position", which changes the swing width, increasing the degree of comfort.



COMPATIBLE WITH ALL PANASONIC CONNECTIVITY SOLUTIONS. FOR DETAILED INFORMATION GO TO THE CONTROL SYSTEMS SECTION

Optional:



			Three phase		
			10,0 kW	12,5 kW	14,0 kW
Kit			KIT-100PT3Z8	KIT-125PT3Z8	KIT-140PT3Z8
Remote controller			CZ-RTC5B	CZ-RTC5B	CZ-RTC5B
Cooling capacity	Nominal (Min - Max)	kW	10,0 (3,0 - 11,5)	12,5 (3,2 - 13,5)	14,0 (3,3 - 15,0)
EER <sup>1)</sup>	Nominal (Min - Max)	W/W	3,64 (3,50 - 5,36)	3,32 (2,77 - 5,33)	2,98 (2,73 - 5,32)
SEER / η <sub>s,c</sub> <sup>2)</sup>			6,5 A++	241,7%	228,8%
Pdesign		kW	10,0	12,5	14,0
Input power	Nominal (Min - Max)	kW	2,75 (0,56 - 4,10)	3,76 (0,60 - 4,88)	4,70 (0,62 - 5,50)
Annual energy consumption <sup>3)</sup>		kWh/a	537	—	—
Heating capacity	Nominal (Min - Max)	kW	10,0 (3,0 - 14,0)	12,5 (3,3 - 15,0)	14,0 (3,4 - 16,0)
Heating capacity at -15 °C <sup>4)</sup>	Max	kW	8,2	10,5	10,8
COP <sup>1)</sup>	Nominal (Min - Max)	W/W	4,24 (3,50 - 5,36)	3,89 (3,41 - 4,52)	3,70 (3,08 - 5,48)
SCOP / η <sub>s,h</sub> <sup>2)</sup>			4,2 A+	147,4%	145,3%
Pdesign at -10 °C		kW	10,0	12,5	13,6
Input power	Nominal (Min - Max)	kW	2,36 (0,56 - 4,00)	3,21 (0,73 - 4,40)	3,78 (0,62 - 5,20)
Annual energy consumption <sup>3)</sup>		kWh/a	3331	—	—
<b>Indoor unit</b>			<b>S-1014PT3E</b>	<b>S-1014PT3E</b>	<b>S-1014PT3E</b>
Air flow	Hi / Med / Lo	m <sup>3</sup> /min	30,0/25,0/23,0	34,0/28,0/24,0	35,0/29,0/25,0
Moisture removal volume		L/h	4,1	5,7	6,9
Sound pressure <sup>5)</sup>	Hi / Med / Lo	dB(A)	42/37/34	46/40/35	47/41/36
Sound power	Hi / Med / Lo	dB(A)	60/55/52	64/58/53	65/59/54
Dimension	H x W x D	mm	235 x 1590 x 690	235 x 1590 x 690	235 x 1590 x 690
Net weight		kg	40	40	40
nanoe X Generator			Mark 2	Mark 2	Mark 2
<b>Outdoor unit</b>			<b>U-100PZ3E8</b>	<b>U-125PZ3E8</b>	<b>U-140PZ3E8</b>
Power supply		V	380 - 400 - 415	380 - 400 - 415	380 - 400 - 415
Current	Cool	A	4,60 - 4,35 - 4,20	6,10 - 5,75 - 5,55	7,60 - 7,20 - 6,95
	Heat	A	3,95 - 3,75 - 3,60	5,20 - 4,95 - 4,75	6,10 - 5,80 - 5,60
Air flow	Cool / Heat	m <sup>3</sup> /min	73,0/73,0	82,0/80,0	84,0/82,0
Sound pressure	Cool / Heat (Hi)	dB(A)	52/52	55/55	56/56
Sound power	Cool / Heat (Hi)	dB(A)	70/70	73/73	74/74
Dimension	H x W x D	mm	996 x 980 x 370	996 x 980 x 370	996 x 980 x 370
Net weight		kg	83	87	87
Piping diameter	Liquid	Inch (mm)	3/8 (9,52)	3/8 (9,52)	3/8 (9,52)
	Gas	Inch (mm)	5/8 (15,88)	5/8 (15,88)	5/8 (15,88)
Pipe length range		m	5 - 50	5 - 50	5 - 50
Elevation difference (in / out) <sup>6)</sup>		m	15/30	15/30	15/30
Pre-charged pipe length		m	30	30	30
Additional gas amount		g/m	45	45	45
Refrigerant (R32) / CO <sub>2</sub> Eq.		kg / T	2,40/1,62	2,8/1,89	2,8/1,89
Operating range	Cool Min ~ Max	°C	-10 ~ +43	-10 ~ +43	-10 ~ +43
	Heat Min ~ Max	°C	-15 ~ +24	-15 ~ +24	-15 ~ +24

1) EER and COP calculation is based in accordance to EN 14511. 2) For models below 12 kW, the SEER and SCOP is calculated based on values of EU/626/2011. For models above 12 kW, the η<sub>s,c</sub> / η<sub>s,h</sub> values is calculated based on EN 14825. 3) Factory setting. 4) The value is based on the interpolation. 5) The sound pressure of the units shows the value measured of the position 1 m in front of the main body and 1 m below the unit. The sound pressure is measured in accordance with Eurovent 6/C/006-97 specification. 6) Connect the liquid socket tube (Ø6,35-Ø9,52) to the liquid tubing side indoor unit. 7) Connect the gas socket tube (Ø12,70-Ø15,88) to the gas tubing side indoor unit. 8) Outdoor unit located lower / outdoor unit located higher. \* Recommended fuse for the indoor 3 A. \*\* Above values are in the case of nanoe™ X OFF.

Accessories

<b>CZ-RTC6W</b>	CONEX wired remote controller (non-wireless), white
<b>CZ-RTC6WBL</b>	CONEX wired remote controller with Bluetooth®, white
<b>CZ-RTC6WBLW2</b>	CONEX wired remote controller with Wi-Fi and Bluetooth®, white
<b>CZ-RTC6</b>	CONEX wired remote controller (non-wireless), black
<b>CZ-RTC6BL</b>	CONEX wired remote controller with Bluetooth®, black
<b>CZ-RTC6BLW2</b>	CONEX wired remote controller with Wi-Fi and Bluetooth®, black
<b>CZ-RTC5B</b>	Wired remote controller with Econavi function
<b>CZ-RWS3 + CZ-RWRT3</b>	Infrared remote controller and receiver

Accessories

<b>CZ-CAPWFC2</b>	Commercial Wi-Fi Adaptor
<b>PAW-PACR4</b>	Interface to run up to 4 indoor unit groups on backup and alternative run
<b>PAW-WTRAY</b>	Tray for condenser water compatible with outdoor elevation platform
<b>PAW-GRDBSE20</b>	Outdoor base ground support for noise and vibration absorption
<b>PAW-GRDSTD40</b>	Outdoor elevation platform 400x900x400 mm
<b>CZ-CENSC1</b>	Econavi energy saving sensor



SEER and SCOP: For S-6071PT3E + U-60PZ3E5A. INTERNET CONTROL: Optional.

Rating conditions: Cooling indoor 27 °C DB / 19 °C WB. Cooling outdoor 35 °C DB / 24 °C WB. Heating indoor 20 °C DB. Heating outdoor 7 °C DB / 6 °C WB. (DB: Dry Bulb, WB: Wet Bulb). Specifications subject to change without notice. For detailed information about ErP / Energy Labelling, please visit our websites www.aircon.panasonic.eu or www.ptc.panasonic.eu.

## PACi NX Series Elite adaptive ducted unit - PF3 · R32

## Adaptive ducted unit - PF3.

2 installation possibilities (horizontal / vertical) with high ESP 150Pa allows flexible installation.



		Single phase							
		3,6 kW	5,0 kW	6,0 kW	7,1 kW	10,0 kW	12,5 kW	14,0 kW	
Kit		KIT-36PF3ZH5	KIT-50PF3ZH5	KIT-60PF3ZH5	KIT-71PF3ZH45	KIT-100PF3ZH45	KIT-125PF3ZH45	KIT-140PF3ZH45	
Remote controller		CZ-RTC5B	CZ-RTC5B	CZ-RTC5B	CZ-RTC5B	CZ-RTC5B	CZ-RTC5B	CZ-RTC5B	
Cooling capacity	Nom (Min - Max)	kW	3,6(1,2 - 4,0)	5,0(1,2 - 5,6)	5,7(1,2 - 6,3)	6,8(2,2 - 7,8)	9,5(3,1 - 11,4)	12,1(3,2 - 13,6)	13,4(3,3 - 15,3)
EER <sup>1)</sup>	Nom (Min - Max)	W/W	4,24(3,57 - 5,45)	3,42(3,11 - 5,45)	3,68(3,15 - 5,45)	3,74(2,41 - 5,64)	4,09(2,82 - 5,08)	3,53(3,00 - 5,00)	3,38(2,59 - 4,18)
SEER / η <sub>s,c</sub> <sup>2)</sup>			6,8 A++	6,1 A++	7,1 A++	7,1 A++	7,4 A++	281,7%	275,9%
Pdesign		kW	3,6	5,0	5,7	6,8	9,5	12,1	13,4
Input power	Nom (Min - Max)	kW	0,85(0,22 - 1,12)	1,46(0,22 - 1,80)	1,55(0,22 - 2,00)	1,82(0,39 - 3,24)	3,23(0,61 - 4,04)	3,43(0,64 - 4,54)	3,96(0,79 - 5,90)
Annual energy consumption <sup>3)</sup>		kWh/a	185	287	281	332	447	—	—
Heating capacity	Nom (Min - Max)	kW	4,0(1,2 - 5,0)	5,6(1,2 - 6,5)	7,0(1,2 - 8,0)	7,5(2,0 - 9,0)	10,8(3,1 - 13,5)	13,5(3,2 - 15,4)	15,5(3,3 - 17,4)
Heating capacity at -15 °C <sup>4)</sup>	Max	kW	3,2	4,1	5,1	7,5	11,5	12,9	14,5
COP <sup>1)</sup>	Nom (Min - Max)	W/W	4,17(3,23 - 5,45)	3,61(2,97 - 5,45)	3,74(3,33 - 5,45)	4,03(3,16 - 5,41)	3,88(3,07 - 5,25)	3,46(3,06 - 5,16)	3,33(3,14 - 4,29)
SCOP / η <sub>s,h</sub> <sup>2)</sup>			4,5 A+	4,2 A+	4,4 A+	4,7 A++	4,3 A+	165,0%	162,6%
Pdesign at -10 °C		kW	3,6	4,0	4,7	4,7	7,8	9,3	9,5
Input power	Nom (Min - Max)	kW	0,96(0,22 - 1,55)	1,55(0,22 - 2,19)	1,87(0,22 - 2,40)	1,86(0,37 - 2,85)	2,78(0,59 - 4,40)	3,90(0,62 - 5,04)	4,65(0,77 - 5,55)
Annual energy consumption <sup>3)</sup>		kWh/a	1120	1333	1495	1393	2540	—	—
<b>Indoor unit</b>			<b>S-3650PF3E</b>	<b>S-3650PF3E</b>	<b>S-6071PF3E</b>	<b>S-6071PF3E</b>	<b>S-1014PF3E</b>	<b>S-1014PF3E</b>	<b>S-1014PF3E</b>
External static pressure <sup>5)</sup>	Nom (Min - Max)	Pa	30(10 - 150)	30(10 - 150)	30(10 - 150)	30(10 - 150)	40(10 - 150)	50(10 - 150)	50(10 - 150)
Air flow	Hi / Med / Lo	m <sup>3</sup> /min	14,0/13,0/10,0	16,0/15,0/12,0	21,0/19,0/15,0	21,0/19,0/15,0	20,0/26,0/21,0	34,0/29,0/23,0	36,0/32,0/25,0
Moisture removal volume		L/h	0,9	1,9	1,7	2,7	3,2	4,1	4,9
Sound pressure <sup>6)</sup>	Hi / Med / Lo	dB(A)	30/27/22	34/30/25	30/26/23	30/26/23	33/29/25	35/31/27	39/35/29
Sound power	Hi / Med / Lo	dB(A)	53/50/45	57/53/48	53/49/46	53/49/46	56/52/48	58/54/50	62/58/52
Dimension	HxWxD	mm	250x800x730	250x800x730	250x1000x730	250x1000x730	250x1400x730	250x1400x730	250x1400x730
Net weight		kg	25	25	30	30	39	39	39
nanoe X Generator			Mark 2	Mark 2	Mark 2	Mark 2	Mark 2	Mark 2	Mark 2
<b>Outdoor unit</b>			<b>U-36PZH3E5</b>	<b>U-50PZH3E5</b>	<b>U-60PZH3E5</b>	<b>U-71PZH4E5</b>	<b>U-100PZH4E5</b>	<b>U-125PZH4E5</b>	<b>U-140PZH4E5</b>
Power supply		V	220 - 230 - 240	220 - 230 - 240	220 - 230 - 240	220 - 230 - 240	220 - 230 - 240	220 - 230 - 240	220 - 230 - 240
Current	Cool	A	4,20 - 4,00 - 3,85	6,90 - 6,60 - 6,35	7,25 - 6,95 - 6,65	9,20 - 8,80 - 8,45	11,50 - 11,00 - 10,50	16,80 - 16,00 - 15,40	19,40 - 18,50 - 17,70
	Heat	A	4,70 - 4,50 - 4,30	7,35 - 7,00 - 6,75	8,65 - 8,30 - 7,95	9,40 - 9,00 - 8,60	13,60 - 13,10 - 12,60	19,10 - 18,20 - 17,50	22,70 - 21,70 - 20,80
Air flow	Cool / Heat	m <sup>3</sup> /min	34,1/36,4	42,0/42,0	42,0/42,0	62,0/66,0	76,0/70,0	86,0/78,0	89,0/83,0
Sound pressure	Cool / Heat (Hi)	dB(A)	43/44	46/48	47/50	48/50	52/52	55/55	56/56
Sound power	Cool / Heat (Hi)	dB(A)	62/64	64/67	65/69	65/67	69/69	73/73	74/74
Dimension	HxWxD	mm	695x875x320	695x875x320	695x875x320	996x980x370	996x980x370	996x980x370	996x980x370
Net weight		kg	42	42	43	66	84	86	86
Piping diameter	Liquid	Inch (mm)	1/4 (6,35)	1/4 (6,35)	1/4 (6,35) <sup>7)</sup>	3/8 (9,52)	3/8 (9,52)	3/8 (9,52)	3/8 (9,52)
	Gas	Inch (mm)	1/2 (12,70)	1/2 (12,70)	1/2 (12,70) <sup>8)</sup>	5/8 (15,88)	5/8 (15,88)	5/8 (15,88)	5/8 (15,88)
Pipe length range		m	3 - 40	3 - 40	3 - 40	5 - 60	5 - 100	5 - 100	5 - 100
Elevation difference (in / out) <sup>9)</sup>		m	15/30	15/30	15/30	15/30	15/30	15/30	15/30
Pre-charged pipe length		m	30	30	30	30	30	30	30
Additional gas amount		g/m	15	15	15	30	40	40	40
Refrigerant (R32) / CO <sub>2</sub> Eq.		kg / T	1,13/0,76	1,13/0,76	1,15/0,78	1,95/1,32	2,70/1,82	3,00/2,03	3,00/2,03
Operating range	Cool Min ~ Max	°C	-15 ~ +46	-15 ~ +46	-15 ~ +46	-15 ~ +52	-20 <sup>10)</sup> ~ +52	-20 <sup>10)</sup> ~ +52	-20 <sup>10)</sup> ~ +52
	Heat Min ~ Max	°C	-20 ~ +24	-20 ~ +24	-20 ~ +24	-20 ~ +24	-20 ~ +24	-20 ~ +24	-20 ~ +24

## Technical focus

- 2 installation possibilities (horizontal / vertical)
- Maximum external static pressure: 150 Pa
- Selectable inlet air position (rear / bottom entry)
- Improved drain pan suitable for both horizontal / vertical installation
- Drain pump included
- nanoe™ X (Generator Mark 2: 9,6 trillion hydroxyl radicals/sec) as standard for the long duct piping case\*
- BION air pollutant filter for certain types of pollutants, such as nitrogen dioxide (NO<sub>2</sub>), nitrogen oxides (NO<sub>x</sub>) and Ozone (O<sub>3</sub>) (optional)
- Wired remote control CZ-RTC6WBL and CZ-RTC6BL allows easy system setting via Bluetooth®

\* The performance of nanoe™ X air can be expected even by 10 m long duct by Panasonic internal survey.

## 2 installation possibilities (horizontal / vertical)

Vertical installation is available. External static pressure 150 Pa, sufficient for remotely installing units away from the rooms.



## Improved drain pan design

Just one drain pan for both horizontal and vertical installations. No need to modify the unit.

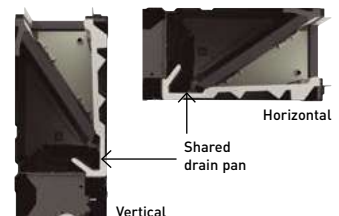



CZ-RTC5B



COMPATIBLE WITH ALL PANASONIC CONNECTIVITY SOLUTIONS. FOR DETAILED INFORMATION GO TO THE CONTROL SYSTEMS SECTION

Optional:



			Three phase			
			7,1 kW	10,0 kW	12,5 kW	14,0 kW
Kit			KIT-71PF3ZH48	KIT-100PF3ZH48	KIT-125PF3ZH48	KIT-140PF3ZH48
Remote controller			CZ-RTC5B	CZ-RTC5B	CZ-RTC5B	CZ-RTC5B
Cooling capacity	Nominal (Min - Max)	kW	6,8 [2,2 - 7,8]	9,5 [3,1 - 11,4]	12,1 [3,2 - 13,6]	13,4 [3,3 - 15,3]
EER <sup>1)</sup>	Nominal (Min - Max)	W/W	3,74 [2,41 - 5,64]	4,09 [2,82 - 5,08]	3,53 [3,00 - 5,00]	3,38 [2,59 - 4,18]
<b>SEER / η<sub>s,c</sub> <sup>2)</sup></b>			<b>7,1 A++</b>	<b>7,4 A++</b>	<b>281,0%</b>	<b>275,2%</b>
Pdesign		kW	6,8	9,5	12,1	13,4
Input power	Nominal (Min - Max)	kW	1,82 [0,39 - 3,24]	2,32 [0,61 - 4,04]	3,43 [0,64 - 4,54]	3,96 [0,79 - 5,90]
Annual energy consumption <sup>3)</sup>		kWh/a	332	447	—	—
Heating capacity	Nominal (Min - Max)	kW	7,5 [2,0 - 9,0]	10,8 [3,1 - 13,5]	13,5 [3,2 - 15,4]	15,5 [3,3 - 17,4]
Heating capacity at -15 °C <sup>4)</sup>	Max	kW	7,5	11,5	12,9	14,5
COP <sup>1)</sup>	Nominal (Min - Max)	W/W	4,03 [3,16 - 5,41]	3,88 [3,07 - 5,25]	3,46 [3,06 - 5,16]	3,33 [3,14 - 4,29]
<b>SCOP / η<sub>s,h</sub> <sup>2)</sup></b>			<b>4,7 A++</b>	<b>4,3 A+</b>	<b>165,0%</b>	<b>162,6%</b>
Pdesign at -10 °C		kW	4,7	7,8	9,3	9,5
Input power	Nominal (Min - Max)	kW	1,86 [0,37 - 2,85]	2,78 [0,59 - 4,40]	3,90 [0,62 - 5,04]	4,65 [0,77 - 5,55]
Annual energy consumption <sup>3)</sup>		kWh/a	1394	2540	—	—
<b>Indoor unit</b>			<b>S-6071PF3E</b>	<b>S-1014PF3E</b>	<b>S-1014PF3E</b>	<b>S-1014PF3E</b>
External static pressure <sup>5)</sup>	Nominal (Min - Max)	Pa	30 [10 - 150]	40 [10 - 150]	50 [10 - 150]	50 [10 - 150]
Air flow	Hi / Med / Lo	m <sup>3</sup> /min	21,0/19,0/15,0	32,0/26,0/21,0	34,0/29,0/23,0	36,0/32,0/25,0
Moisture removal volume		L/h	2,7	3,2	4,1	4,9
Sound pressure <sup>6)</sup>	Hi / Med / Lo	dB(A)	30/26/23	33/29/25	35/31/27	39/35/29
Sound power	Hi / Med / Lo	dB(A)	53/49/46	56/52/48	58/54/50	62/58/52
Dimension	H x W x D	mm	250 x 1000 x 730	250 x 1400 x 730	250 x 1400 x 730	250 x 1400 x 730
Net weight		kg	30	39	39	39
nanoe X Generator			Mark 2	Mark 2	Mark 2	Mark 2
<b>Outdoor unit</b>			<b>U-71PZH4E8</b>	<b>U-100PZH4E8</b>	<b>U-125PZH4E8</b>	<b>U-140PZH4E8</b>
Power supply		V	380 - 400 - 415	380 - 400 - 415	380 - 400 - 415	380 - 400 - 415
Current	Cool	A	3,05 - 2,90 - 2,80	3,85 - 3,70 - 3,50	5,65 - 5,40 - 5,20	6,55 - 6,20 - 6,00
	Heat	A	3,15 - 3,00 - 2,90	4,65 - 4,40 - 4,20	6,50 - 6,20 - 5,95	7,75 - 7,40 - 7,05
Air flow	Cool / Heat	m <sup>3</sup> /min	62,0/66,0	76,0/70,0	86,0/78,0	89,0/83,0
Sound pressure	Cool / Heat (Hi)	dB(A)	48/50	52/52	55/55	56/56
Sound power	Cool / Heat (Hi)	dB(A)	65/67	69/69	73/73	74/74
Dimension	H x W x D	mm	996 x 980 x 370	996 x 980 x 370	996 x 980 x 370	996 x 980 x 370
Net weight		kg	66	82	84	84
Piping diameter	Liquid	Inch (mm)	3/8 (9,52)	3/8 (9,52)	3/8 (9,52)	3/8 (9,52)
	Gas	Inch (mm)	5/8 (15,88)	5/8 (15,88)	5/8 (15,88)	5/8 (15,88)
Pipe length range		m	5 - 60	5 - 100	5 - 100	5 - 100
Elevation difference (in / out) <sup>9)</sup>		m	15/30	15/30	15/30	15/30
Pre-charged pipe length		m	30	30	30	30
Additional gas amount		g/m	30	40	40	40
Refrigerant (R32) / CO <sub>2</sub> Eq.		kg / T	1,95/1,32	2,70/1,82	3,00/2,03	3,00/2,03
Operating range	Cool Min ~ Max	°C	-15 ~ +52	-20 <sup>10)</sup> ~ +52	-20 <sup>10)</sup> ~ +52	-20 <sup>10)</sup> ~ +52
	Heat Min ~ Max	°C	-20 ~ +24	-20 ~ +24	-20 ~ +24	-20 ~ +24

1) EER and COP calculation is based in accordance to EN 14511. 2) For models below 12 kW, the SEER and SCOP is calculated based on values of EU/626/2011. For models above 12 kW, the η<sub>s,c</sub> / η<sub>s,h</sub> values is calculated based on EN 14825. 3) Factory setting. 4) The value is based on the interpolation. 5) Medium external static pressure setting from factory. 6) The sound pressure of the units shows the value measured of the position 1,5 m below the unit. The sound pressure is measured in accordance with Eurovent 6/C/006-97 specification. 7) Connect the liquid socket tube (Ø6,35-Ø9,52) to the liquid tubing side indoor unit. 8) Connect the gas socket tube (Ø12,70-Ø15,88) to the gas tubing side indoor unit. 9) Outdoor unit located lower / outdoor unit located higher. 10) Pipe length up to 30 m. \* Recommended fuse for the indoor 3 A. \*\* Above values are in the case of standard installation (horizontal installation in the ceiling, rear side air intake) and nanoe™ X OFF.

Accessories	
<b>CZ-RTC6W</b>	CONEX wired remote controller (non-wireless), white
<b>CZ-RTC6WBL</b>	CONEX wired remote controller with Bluetooth®, white
<b>CZ-RTC6WBLW2</b>	CONEX wired remote controller with Wi-Fi and Bluetooth®, white
<b>CZ-RTC6</b>	CONEX wired remote controller (non-wireless), black
<b>CZ-RTC6BL</b>	CONEX wired remote controller with Bluetooth®, black
<b>CZ-RTC6BLW2</b>	CONEX wired remote controller with Wi-Fi and Bluetooth®, black
<b>CZ-RTC5B</b>	Wired remote controller with Econavi function
<b>CZ-RWS3 + CZ-RWRC3</b>	Infrared remote controller and receiver
<b>CZ-CAPWFC2</b>	Commercial Wi-Fi Adaptor
<b>PAW-PACR4</b>	Interface to run up to 4 indoor unit groups on backup and alternative run

Accessories	
<b>PAW-WTRAY</b>	Tray for condenser water compatible with outdoor elevation platform
<b>PAW-GRDBSE20</b>	Outdoor base ground support for noise and vibration absorption
<b>PAW-GRDSTD40</b>	Outdoor elevation platform 400 x 900 x 400 mm
<b>CZ-CENSC1</b>	Econavi energy saving sensor
<b>CZ-56DAF2</b>	Air outlet plenum for S-3650PF3E
<b>CZ-90DAF2</b>	Air outlet plenum for S-6071PF3E
<b>CZ-160DAF2</b>	Air outlet plenum for S-1014PF3E
<b>PAW-APF800F</b>	BION air pollutant filter for S-3650PF3E
<b>PAW-APF1000F</b>	BION air pollutant filter for S-6071PF3E
<b>PAW-APF1400F</b>	BION air pollutant filter for S-1014PF3E

SEER and SCOP: For S-6071PF3E + U-71PZH4E5. SUPER QUIET: For S-3650PF3E + U-36PZH3E5. INTERNET CONTROL: Optional.

Rating conditions: Cooling indoor 27 °C DB / 19 °C WB. Cooling outdoor 35 °C DB / 24 °C WB. Heating indoor 20 °C DB. Heating outdoor 7 °C DB / 6 °C WB. (DB: Dry Bulb, WB: Wet Bulb). Specifications subject to change without notice. For detailed information about ErP / Energy Labelling, please visit our websites www.aircon.panasonic.eu or www.ptc.panasonic.eu.

## PACi NX Series Standard adaptive ducted unit - PF3 · R32

## Adaptive ducted unit - PF3.

2 installation possibilities (horizontal / vertical) with high ESP 150Pa allows flexible installation.



			Single phase						
			3,6 kW	5,0 kW	6,0 kW	7,1 kW	10,0 kW	12,5 kW	14,0 kW
Kit			KIT-36PF3Z5	KIT-50PF3Z5	KIT-60PF3Z5	KIT-71PF3Z5	KIT-100PF3Z5	KIT-125PF3Z5	KIT-140PF3Z5
Remote controller			CZ-RTC5B	CZ-RTC5B	CZ-RTC5B	CZ-RTC5B	CZ-RTC5B	CZ-RTC5B	CZ-RTC5B
Cooling capacity	Nom (Min - Max)	kW	3,4(1,5 - 4,0)	5,0(1,5 - 5,3)	5,7(2,0 - 6,3)	6,8(2,6 - 7,7)	9,5(3,0 - 11,4)	12,1(3,2 - 13,5)	13,4(3,3 - 15,0)
EER <sup>1)</sup>	Nom (Min - Max)	W/W	3,78(3,51 - 5,00)	2,78(2,76 - 4,63)	3,54(2,63 - 5,88)	3,18(2,69 - 4,56)	3,57(2,36 - 5,08)	3,40(2,76 - 5,08)	3,16(2,56 - 5,08)
SEER / η <sub>s,c</sub> <sup>2)</sup>			6,0 A+	6,5 A++	6,4 A++	6,0 A+	6,6 A++	257,4%	252,2%
Pdesign		kW	3,4	5,0	5,7	6,8	9,5	12,1	13,4
Input power	Nom (Min - Max)	kW	0,90(0,30 - 1,14)	1,80(0,32 - 1,92)	1,61(0,34 - 2,40)	2,14(0,57 - 2,86)	2,66(0,59 - 4,84)	3,56(0,63 - 4,90)	4,24(0,65 - 5,86)
Annual energy consumption <sup>3)</sup>		kWh/a	198	267	310	391	502	—	—
Heating capacity	Nom (Min - Max)	kW	3,4(1,5 - 4,6)	5,0(1,5 - 5,9)	5,7(1,8 - 7,0)	6,8(2,1 - 8,1)	9,5(3,0 - 13,5)	12,1(3,3 - 15,0)	13,4(3,4 - 16,0)
Heating capacity at -15 °C <sup>4)</sup>	Max	kW	2,6	3,5	4,7	4,8	8,0	10,5	10,8
COP <sup>1)</sup>	Nom (Min - Max)	W/W	4,15(3,51 - 5,36)	3,62(3,06 - 5,36)	4,04(2,82 - 6,21)	4,00(3,03 - 5,68)	4,09(3,00 - 5,08)	3,56(3,16 - 5,24)	3,76(3,03 - 5,23)
SCOP / η <sub>s,h</sub> <sup>2)</sup>			4,0 A+	4,0 A+	4,4 A+	4,1 A+	3,9 A	142,6%	140,6%
Pdesign at -10 °C		kW	2,4	3,8	4,4	4,7	7,8	9,3	9,5
Input power	Nom (Min - Max)	kW	0,82(0,28 - 1,31)	1,38(0,28 - 1,73)	1,41(0,29 - 2,48)	1,70(0,37 - 2,67)	2,32(0,59 - 4,50)	3,40(0,63 - 4,74)	3,56(0,65 - 5,28)
Annual energy consumption <sup>3)</sup>		kWh/a	839	1303	1376	1591	2795	—	—
<b>Indoor unit</b>			<b>S-3650PF3E</b>	<b>S-3650PF3E</b>	<b>S-6071PF3E</b>	<b>S-6071PF3E</b>	<b>S-1014PF3E</b>	<b>S-1014PF3E</b>	<b>S-1014PF3E</b>
External static pressure <sup>5)</sup>	Nom (Min - Max)	Pa	30(10 - 150)	30(10 - 150)	30(10 - 150)	30(10 - 150)	40(10 - 150)	50(10 - 150)	50(10 - 150)
Air flow	Hi / Med / Lo	m <sup>3</sup> /min	14,0/13,0/10,0	16,0/15,0/12,0	21,0/19,0/15,0	21,0/19,0/15,0	32,0/26,0/21,0	34,0/29,0/23,0	36,0/32,0/25,0
Moisture removal volume		L/h	0,9	1,9	1,7	2,7	3,2	4,1	4,9
Sound pressure <sup>6)</sup>	Hi / Med / Lo	dB(A)	30/27/22	34/30/25	30/26/23	30/26/23	33/29/25	35/31/27	39/35/29
Sound power	Hi / Med / Lo	dB(A)	53/50/45	57/53/48	53/49/46	53/49/46	56/52/48	58/54/50	62/58/52
Dimension	HxWxD	mm	250x800x730	250x800x730	250x1000x730	250x1000x730	250x1400x730	250x1400x730	250x1400x730
Net weight		kg	25	25	30	30	39	39	39
nanoe X Generator			Mark 2	Mark 2	Mark 2	Mark 2	Mark 2	Mark 2	Mark 2
<b>Outdoor unit</b>			<b>U-36PZ3E5</b>	<b>U-50PZ3E5</b>	<b>U-60PZ3E5A</b>	<b>U-71PZ3E5A</b>	<b>U-100PZ3E5</b>	<b>U-125PZ3E5</b>	<b>U-140PZ3E5</b>
Power supply	V		220 - 230 - 240	220 - 230 - 240	220 - 230 - 240	220 - 230 - 240	220 - 230 - 240	220 - 230 - 240	220 - 230 - 240
Current	Cool	A	4,15-4,00-3,85	8,35-8,00-7,65	7,45-7,15-6,85	9,95-9,50-9,10	13,30-12,70-12,20	17,20-16,40-15,80	20,50-19,60-18,8
	Heat	A	3,85-3,70-3,50	6,45-6,20-5,95	6,55-6,25-6,00	7,90-7,55-7,25	11,60-11,10-10,60	16,40-15,70-15,00	17,20-16,40-15,80
Air flow	Cool / Heat	m <sup>3</sup> /min	33,6/34,0	32,7/31,9	42,6/41,5	44,7/45,9	73,0/73,0	82,0/80,0	84,0/82,0
Sound pressure	Cool / Heat (Hi)	dB(A)	46/47	46/46	47/48	48/49	52/52	55/55	56/56
Sound power	Cool / Heat (Hi)	dB(A)	64/66	64/64	64/65	66/68	70/70	73/73	74/74
Dimension	HxWxD	mm	619x824x299	619x824x299	695x875x320	695x875x320	996x980x370	996x980x370	996x980x370
Net weight		kg	32	35	42	50	83	87	87
Piping diameter	Liquid	Inch (mm)	1/4(Ø6,35)	1/4(Ø6,35)	1/4(Ø6,35) <sup>7)</sup>	1/4(Ø6,35) <sup>7)</sup>	3/8(9,52)	3/8(9,52)	3/8(9,52)
	Gas	Inch (mm)	1/2(Ø12,7)	1/2(Ø12,7)	1/2(Ø12,7) <sup>8)</sup>	5/8(Ø15,88)	5/8(15,88)	5/8(15,88)	5/8(15,88)
Pipe length range	m		3 - 15	3 - 20	3 - 40	3 - 40	5 - 50	5 - 50	5 - 50
Elevation difference (in / out) <sup>9)</sup>	m		15/15	15/15	15/30	20/30	15/30	15/30	15/30
Pre-charged pipe length	m		7,5	7,5	30	30	30	30	30
Additional gas amount	g/m		10	15	15	17	45	45	45
Refrigerant (R32) / CO <sub>2</sub> Eq.	kg / T		0,87/0,59	1,14/0,77	1,15/0,78	1,32/0,89	2,40/1,62	2,80/1,89	2,80/1,89
Operating range	Cool Min ~ Max	°C	-10 ~ +43	-10 ~ +43	-10 ~ +43	-10 ~ +43	-10 ~ +43	-10 ~ +43	-10 ~ +43
	Heat Min ~ Max	°C	-15 ~ +24	-15 ~ +24	-15 ~ +24	-15 ~ +24	-15 ~ +24	-15 ~ +24	-15 ~ +24

## Technical focus

- 2 installation possibilities (horizontal / vertical)
- Maximum external static pressure: 150 Pa
- Selectable inlet air position (rear / bottom entry)
- Improved drain pan suitable for both horizontal / vertical installation
- Drain pump included
- nanoe™ X (Generator Mark 2: 9,6 trillion hydroxyl radicals/sec) as standard for the long duct piping case\*
- BION air pollutant filter for certain types of pollutants, such as nitrogen dioxide (NO<sub>2</sub>), nitrogen oxides (NO<sub>x</sub>) and Ozone (O<sub>3</sub>) (optional)
- Wired remote control CZ-RTC6WBL and CZ-RTC6BL allows easy system setting via Bluetooth®

\* The performance of nanoe™ X air can be expected even by 10 m long duct by Panasonic internal survey.

## 2 installation possibilities (horizontal / vertical)

Vertical installation is available. External static pressure 150 Pa, sufficient for remotely installing units away from the rooms.



## Improved drain pan design

Just one drain pan for both horizontal and vertical installations. No need to modify the unit.

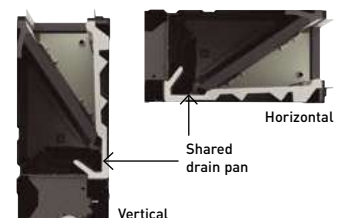





COMPATIBLE WITH ALL PANASONIC CONNECTIVITY SOLUTIONS. FOR DETAILED INFORMATION GO TO THE CONTROL SYSTEMS SECTION

Optional:



Infrared remote controller. CZ-RWS3 + CZ-RWRC3

Econavi sensor. CZ-CENSC1

			Three phase		
			10,0 kW	12,5 kW	14,0 kW
Kit			KIT-100PF3Z8	KIT-125PF3Z8	KIT-140PF3Z8
Remote controller			CZ-RTC5B	CZ-RTC5B	CZ-RTC5B
Cooling capacity	Nominal (Min - Max)	kW	9,5(3,0 - 11,4)	12,1(3,2 - 13,5)	13,4(3,3 - 15,0)
EER <sup>1)</sup>	Nominal (Min - Max)	W/W	3,57(2,36 - 5,08)	3,40(2,76 - 5,08)	3,16(2,56 - 5,08)
SEER / η <sub>s,c</sub> <sup>2)</sup>			6,5 A++	256,2%	251,4%
Pdesign		kW	9,5	12,1	13,4
Input power	Nominal (Min - Max)	kW	2,66(0,59 - 4,84)	3,56(0,63 - 4,90)	4,24(0,65 - 5,86)
Annual energy consumption <sup>3)</sup>		kWh/a	508	—	—
Heating capacity	Nominal (Min - Max)	kW	9,5(3,0 - 13,5)	12,1(3,3 - 15,0)	13,4(3,4 - 16,0)
Heating capacity at -15 °C <sup>4)</sup>	Max	kW	8,0	10,5	10,8
COP <sup>1)</sup>	Nominal (Min - Max)	W/W	4,09(3,00 - 5,08)	3,56(3,16 - 5,24)	3,76(3,03 - 5,23)
SCOP / η <sub>s,h</sub> <sup>2)</sup>			3,9 A	142,6%	140,6%
Pdesign at -10 °C		kW	7,8	9,3	9,5
Input power	Nominal (Min - Max)	kW	2,32(0,59 - 4,50)	3,40(0,63 - 4,74)	3,56(0,65 - 5,28)
Annual energy consumption <sup>3)</sup>		kWh/a	2795	—	—
Indoor unit			S-1014PF3E	S-1014PF3E	S-1014PF3E
External static pressure <sup>5)</sup>	Nominal (Min - Max)	Pa	40(10 - 150)	50(10 - 150)	50(10 - 150)
Air flow	Hi / Med / Lo	m <sup>3</sup> /min	32,0/26,0/21,0	34,0/29,0/23,0	36,0/32,0/25,0
Moisture removal volume		L/h	3,2	4,1	4,9
Sound pressure <sup>6)</sup>	Hi / Med / Lo	dB(A)	33/29/25	35/31/27	39/35/29
Sound power	Hi / Med / Lo	dB(A)	56/52/48	58/54/50	62/58/52
Dimension	H x W x D	mm	250 x 1400 x 730	250 x 1400 x 730	250 x 1400 x 730
Net weight		kg	39	39	39
nanoe X Generator			Mark 2	Mark 2	Mark 2
Outdoor unit			U-100PZ3E8	U-125PZ3E8	U-140PZ3E8
Power supply		V	380 - 400 - 415	380 - 400 - 415	380 - 400 - 415
Current	Cool	A	4,45 - 4,20 - 4,05	5,75 - 5,45 - 5,25	6,85 - 6,50 - 6,30
	Heat	A	3,85 - 3,70 - 3,55	5,50 - 5,20 - 5,05	5,75 - 5,45 - 5,25
Air flow	Cool / Heat	m <sup>3</sup> /min	73,0/73,0	82,0/80,0	84,0/82,0
Sound pressure	Cool / Heat (Hi)	dB(A)	52/52	55/55	56/56
Sound power	Cool / Heat (Hi)	dB(A)	70/70	73/73	74/74
Dimension	H x W x D	mm	996 x 980 x 370	996 x 980 x 370	996 x 980 x 370
Net weight		kg	83	87	87
Piping diameter	Liquid	Inch (mm)	3/8(9,52)	3/8(9,52)	3/8(9,52)
	Gas	Inch (mm)	5/8(15,88)	5/8(15,88)	5/8(15,88)
Pipe length range		m	5 - 50	5 - 50	5 - 50
Elevation difference (in / out) <sup>9)</sup>		m	15/30	15/30	15/30
Pre-charged pipe length		m	30	30	30
Additional gas amount		g/m	45	45	45
Refrigerant (R32) / CO <sub>2</sub> Eq.		kg / T	2,40/1,62	2,80/1,89	2,80/1,89
Operating range	Cool Min ~ Max	°C	-10 ~ +43	-10 ~ +43	-10 ~ +43
	Heat Min ~ Max	°C	-15 ~ +24	-15 ~ +24	-15 ~ +24

1) EER and COP calculation is based in accordance to EN 14511. 2) For models below 12 kW, the SEER and SCOP is calculated based on values of EU/626/2011. For models above 12 kW, the η<sub>s,c</sub> / η<sub>s,h</sub> values is calculated based on EN 14825. 3) Factory setting. 4) The value is based on the interpolation. 5) Medium external static pressure setting from factory. 6) The sound pressure of the units shows the value measured of the position 1,5 m below the unit. The sound pressure is measured in accordance with Eurovent 6/C/006-97 specification. 7) Connect the liquid socket tube (Ø6,35-Ø9,52) to the liquid tubing side indoor unit. 8) Connect the gas socket tube (Ø12,70-Ø15,88) to the gas tubing side indoor unit. 9) Outdoor unit located lower / outdoor unit located higher. \* Recommended fuse for the indoor 3 A. \*\* Above values are in the case of standard installation(horizontal installation in the ceiling, rear side air intake) and nanoe™ X OFF.

Accessories	
CZ-RTC6W	CONEX wired remote controller (non-wireless), white
CZ-RTC6WBL	CONEX wired remote controller with Bluetooth®, white
CZ-RTC6WBLW2	CONEX wired remote controller with Wi-Fi and Bluetooth®, white
CZ-RTC6	CONEX wired remote controller (non-wireless), black
CZ-RTC6BL	CONEX wired remote controller with Bluetooth®, black
CZ-RTC6BLW2	CONEX wired remote controller with Wi-Fi and Bluetooth®, black
CZ-RTC5B	Wired remote controller with Econavi function
CZ-RWS3+CZ-RWRC3	Infrared remote controller and receiver
CZ-CAPWFC2	Commercial Wi-Fi Adaptor
PAW-PACR4	Interface to run up to 4 indoor unit groups on backup and alternative run

Accessories	
PAW-WTRAY	Tray for condenser water compatible with outdoor elevation platform
PAW-GRDBSE20	Outdoor base ground support for noise and vibration absorption
PAW-GRDSTD40	Outdoor elevation platform 400x900x400 mm
CZ-CENSC1	Econavi energy saving sensor
CZ-56DAF2	Air outlet plenum for S-3650PF3E
CZ-90DAF2	Air outlet plenum for S-6071PF3E
CZ-160DAF2	Air outlet plenum for S-1014PF3E
PAW-APF800F	BION air pollutant filter for S-3650PF3E
PAW-APF1000F	BION air pollutant filter for S-6071PF3E
PAW-APF1400F	BION air pollutant filter for S-1014PF3E



SEER: For S-1014PF3E + U-100PZ3E5. SCOP: For S-6071PF3E + U-60PZ3E5A. SUPER QUIET: For S-3650PF3E + U-36PZ3E5. INTERNET CONTROL: Optional.

Rating conditions: Cooling indoor 27 °C DB / 19 °C WB. Cooling outdoor 35 °C DB / 24 °C WB. Heating indoor 20 °C DB. Heating outdoor 7 °C DB / 6 °C WB. (DB: Dry Bulb; WB: Wet Bulb). Specifications subject to change without notice. For detailed information about ErP / Energy Labelling, please visit our websites www.aircon.panasonic.eu or www.ptc.panasonic.eu.

Big PACi NX high static pressure hide-away 20,0-25,0 kW · R32

Optional:

**CONEX** CONEX wired remote controller, white. CZ-RTC6W/BL/BLW2

**CONEX** CONEX wired remote controller, black. CZ-RTC6/BL/BLW2

Infrared remote controller. CZ-RWS3 + CZ-RWRC3

Econavi sensor. CZ-CENSC1



			Three phase	
			20,0 kW	25,0 kW
Kit			KIT-200PE4ZH8	KIT-250PE4ZH8
Remote controller			CZ-RTC5B	CZ-RTC5B
Cooling capacity	Nominal (Min - Max)	kW	19,0 (5,7 - 20,0)	22,0 (6,1 - 25,6)
EER <sup>1)</sup>	Nominal (Min - Max)	W/W	3,20 (2,78 - 4,60)	2,74 (2,49 - 4,88)
$\eta_{s,c}$ <sup>2)</sup>			<b>237,8%</b>	<b>213,0%</b>
Pdesign		kW	19,0	22,0
Input power	Nominal (Min - Max)	kW	5,93 (1,24 - 7,20)	8,04 (1,25 - 10,30)
Heating capacity	Nominal (Min - Max)	kW	22,4 (5,0 - 24,5)	24,0 (5,5 - 27,6)
Heating capacity at -15 °C <sup>3)</sup>	Max	kW	16,8	19,0
COP <sup>1)</sup>	Nominal (Min - Max)	W/W	3,55 (3,27 - 4,76)	3,55 (3,07 - 4,78)
$\eta_{s,h}$ <sup>2)</sup>			<b>146,0%</b>	<b>145,0%</b>
Pdesign at -10 °C		kW	16,0	17,2
Input power	Nominal (Min - Max)	kW	6,31 (1,05 - 7,50)	6,76 (1,15 - 9,00)
Indoor unit			S-200PE4E	S-250PE4E
External static pressure at shipment (adjustable)		Pa	75 <sup>4)</sup> (120 / 180)	75 <sup>4)</sup> (130 / 200)
Air flow	Hi / Med / Lo	m <sup>3</sup> /min	72/63/53	84/72/59
Sound pressure <sup>5)</sup>	Hi / Med / Lo	dB(A)	46/44/41	47/45/42
Dimension / Net weight	H x W x D	mm / kg	486 x 1456 x 916 / 83	486 x 1456 x 916 / 87
nanoe X Generator			Mark 3	Mark 3
Outdoor unit			U-200PZH4E8	U-250PZH4E8
Power supply		V / ph / Hz	380 - 400 - 415 / 3 / 50	380 - 400 - 415 / 3 / 50
Recommended fuse		A	30	30
Air flow	Cool / Heat	m <sup>3</sup> /min	116 / 136	116 / 148
Sound pressure	Cool / Heat (Hi)	dB(A)	57 / 61	57 / 63
Sound power	Cool / Heat (Hi)	dB(A)	76 / 80	76 / 82
Dimension <sup>6)</sup> / Net weight	H x W x D	mm / kg	996 x 1140 x 460 / 109	996 x 1140 x 460 / 109
Piping diameter	Liquid / Gas	Inch (mm)	1/2 (12,7) / 7/8 (22,22)	1/2 (12,7) / 7/8 (22,22)
Pipe length range / Elevation difference (in / out)		m / m	5 - 100 / 30	5 - 100 / 30
Pre-charged pipe length / Additional gas amount		m / g/m	30 / 80	30 / 80
Refrigerant (R32) / CO <sub>2</sub> Eq.		kg / T	4,8 / 3,24	4,8 / 3,24
Operating range	Cool Min ~ Max	°C	-15 ~ +52	-15 ~ +52
	Heat Min ~ Max	°C	-20 ~ +35	-20 ~ +35

1) EER and COP calculation is based in accordance to EN 14511. 2) Energy Label Scale from A+++ to D. For models above 12 kW, the  $\eta_{s,c}$  /  $\eta_{s,h}$  values is calculated based on EN 14825. 3) The value is based on the interpolation. 4) Factory setting. 5) The sound pressure of the units shows the value measured of the position 1,5 m below the unit. The sound pressure is measured in accordance with Eurovent 6/C/006-97 specification. 6) Add 100 mm for indoor unit or 70 mm for outdoor unit for piping port.

Accessories	
<b>CZ-RTC6W</b>	CONEX wired remote controller (non-wireless), white
<b>CZ-RTC6WBL</b>	CONEX wired remote controller with Bluetooth®, white
<b>CZ-RTC6WBLW2</b>	CONEX wired remote controller with Wi-Fi and Bluetooth®, white
<b>CZ-RTC6</b>	CONEX wired remote controller (non-wireless), black
<b>CZ-RTC6BL</b>	CONEX wired remote controller with Bluetooth®, black
<b>CZ-RTC6BLW2</b>	CONEX wired remote controller with Wi-Fi and Bluetooth®, black
<b>CZ-RTC5B</b>	Wired remote controller with Econavi function

Accessories	
<b>CZ-RWS3 + CZ-RWRC3</b>	Infrared remote controller and receiver
<b>CZ-CAPWFC2</b>	Commercial Wi-Fi Adaptor
<b>PAW-PACR4</b>	Interface to run up to 4 indoor unit groups on backup and alternative run
<b>PAW-GRDSTD1100</b>	Outdoor ground stand
<b>PAW-GRDBSE20</b>	Outdoor base ground support for noise and vibration absorption
<b>CZ-CENSC1</b>	Econavi energy saving sensor

Demand response compliant as a standard function

Several setting levels are available:

- Level-1, 2, 3: 75 / 50 / 0%
- Level-1, 2 can be set in 40 - 100% (40, 45, 50...95, 100: each 5%)

It allows for forced stop which can be used for fire-alarm connection on LV3.

\* PAW-OPT-NX is required.

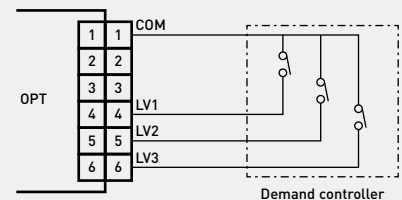

Indoor unit control PCB

+ COMPATIBLE WITH ALL PANASONIC CONNECTIVITY SOLUTIONS. FOR DETAILED INFORMATION GO TO THE CONTROL SYSTEMS SECTION

R32 REFRIGERANT | INVERTER+ HIGH EFFICIENCY COMPRESSOR | -15 °C COOLING MODE | -20 °C HEATING MODE | nanoe X | BLUEFIN | LARGE FAN | R32 R410A R32 R22 / R410A RENEWAL | OPTIONAL WI-FI | BMS CONNECTIVITY | 5 YEARS COMPRESSOR WARRANTY

INTERNET CONTROL: Optional.

## PACi NX Jet Air Stream · R32

- Energy-saving solution for year-round heating and cooling in large and high spaces
- High air volume up to 5000 m<sup>3</sup>/h and long maximum air throw distance of 30 m
- Optimal comfort with Smart Jet - self-directing nozzles



Touch panel controller.  
PCZ-AHRX0012



Air flow			2500 m <sup>3</sup> /h	2500 m <sup>3</sup> /h	5000 m <sup>3</sup> /h
<b>Kit</b>			<b>KIT-140MC5ZH5</b>	<b>KIT-140MC5ZH8</b>	<b>KIT-250MC5ZH8</b>
<b>Remote controller</b>			<b>PCZ-AHRX0012</b>	<b>PCZ-AHRX0012</b>	<b>PCZ-AHRX0012</b>
Cooling capacity	Nominal (Min - Max)	kW	14,1 [3,3 - 18,0]	14,1 [3,3 - 18,0]	24,2 [6,1 - 25,6]
EER <sup>1)</sup>	Nominal (Min - Max)	W/W	3,46 [2,74 - 5,32]	3,46 [2,74 - 5,32]	3,80 [2,49 - 4,88]
$\eta_{s,c}$ <sup>2)</sup>			<b>227%</b>	<b>227%</b>	<b>250%</b>
Pdesign		kW	—	—	—
Heating capacity	Nominal (Min - Max)	kW	14,0 [3,3 - 18,0]	14,0 [3,3 - 18,0]	26,7 [5,5 - 27,6]
COP <sup>1)</sup>	Nominal (Min - Max)	W/W	3,88 [3,27 - 5,50]	3,88 [3,27 - 5,50]	3,74 [3,07 - 4,78]
$\eta_{s,h}$ <sup>2)</sup>			<b>155%</b>	<b>155%</b>	<b>155%</b>
Pdesign at -10 °C		kW	11,0	11,0	18,5
			<b>Jet Air Stream Smart</b>	<b>Jet Air Stream Smart</b>	<b>Jet Air Stream Smart</b>
<b>Indoor unit</b>			<b>P-VTVF140MC5-PE</b>	<b>P-VTVF140MC5-PE</b>	<b>P-VTVF250MC5-PE</b>
Nozzles type			Smart Jet - self-directing nozzles	Smart Jet - self-directing nozzles	Smart Jet - self-directing nozzles
Number of nozzles			2	2	4
External static pressure			170	170	170
Air flow			2560	2560	5010
Sound pressure <sup>3)</sup>	Cool / Heat	dB(A)	42	42	46
Sound power <sup>4)</sup>	Hi / Med / Lo	dB(A)	—	—	—
Dimension	HxWxD	mm	802 x 1105 x 893	802 x 1105 x 893	1026 x 1458 x 953
Net weight		kg	88	88	130
<b>Outdoor unit</b>			<b>U-140PZH4E5</b>	<b>U-140PZH4E8</b>	<b>U-250PZH4E8</b>
Power supply	V / ph / Hz		220 - 230 - 240/1/50	380 - 400 - 415/3/50	380 - 400 - 415/3/50
Recommended fuse	A		40	16	30
Sound pressure	Cool / Heat (Hi)	dB(A)	56/56	56/56	59/63
Dimension	HxWxD	mm	996 x 980 x 370	996 x 980 x 370	996 x 1140 x 460
Net weight		kg	86	84	109
Piping diameter	Liquid	Inch (mm)	3/8 (9,52)	3/8 (9,52)	1/2 (12,70)
	Gas	Inch (mm)	5/8 (15,88)	5/8 (15,88)	7/8 (22,22)
Pipe length range	m		5 - 100	5 - 100	5 - 100
Elevation difference (in / out)	m		15/30 <sup>5)</sup>	15/30 <sup>5)</sup>	30
Pre-charged pipe length	m		30	30	30
Additional gas amount	g/m		40	40	80
Refrigerant (R32) / CO <sub>2</sub> Eq.	kg / T		3,00/2,03	3,00/2,03	4,80/3,24
Operating range	Cool Min ~ Max	°C	-20 <sup>6)</sup> ~ +52	-20 <sup>6)</sup> ~ +52	-15 ~ +52
	Heat Min ~ Max	°C	-20 ~ +24	-20 ~ +24	-20 ~ +35

1) EER and COP calculation is based in accordance to EN 14511. 2) For models above 12 kW, the  $\eta_{s,c}$  /  $\eta_{s,h}$  values is calculated based on EN 14825. 3) Average sound pressure at 5 m Lp. 4) Radiated sound power at 5 m Lp. 5) Outdoor unit located lower / outdoor unit located higher. 6) Pipe length up to 30 m.

Optional configurations*	Front panel type	Air flow (m <sup>3</sup> /h)
<b>P-VTVF140NC5-PE</b> Jet Air Stream Standard	Manual nozzles	2500
<b>P-VTVF250NC5-PE</b> Jet Air Stream Standard	Manual nozzles	5000
<b>P-VTVF140PC5-PE</b> Jet Air Stream Ducted	Ducted front panel	2500
<b>P-VTVF250PC5-PE</b> Jet Air Stream Ducted	Ducted front panel	5000

\* The product technical data is the same as Jet Air Stream Smart.

Accessories	
<b>PCZ-AHRX0012</b>	Touch panel controller with Modbus integration and group control up to 8 units
<b>PCZ-AHRP0681</b>	Recessed mounting box for controller
<b>A PCZ-AHRX0051</b>	Ducted air intake plenum (1 x DN 355 mm) for VTVF140N and VTVF140P
<b>A PCZ-AHRX0052</b>	Ducted air intake plenum (2 x DN 355 mm) for VTVF250N and VTVF250P
<b>B PCZ-AHRX0061</b>	Ground air intake module (VTVF250 requires two of them)
<b>C PCZ-AHRX0071</b>	Air supply grille for ducts

## Accessories for remote air intake configurations.

Manual version.



Ducted version.

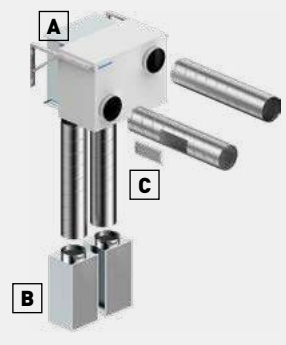

## Commercial twin, triple and double-twin systems - R32



With this system, a single outdoor unit can split its capacity simultaneously across up to 4 indoor units, for better distribution within the space. This makes the system particularly apt for common areas. It reduces noise concentration and enables the same temperature to be reached around the room. A wide variety of the same type of indoor units can be connected in multi combinations (including wall-mounted, cassette, hide-away and ceiling).

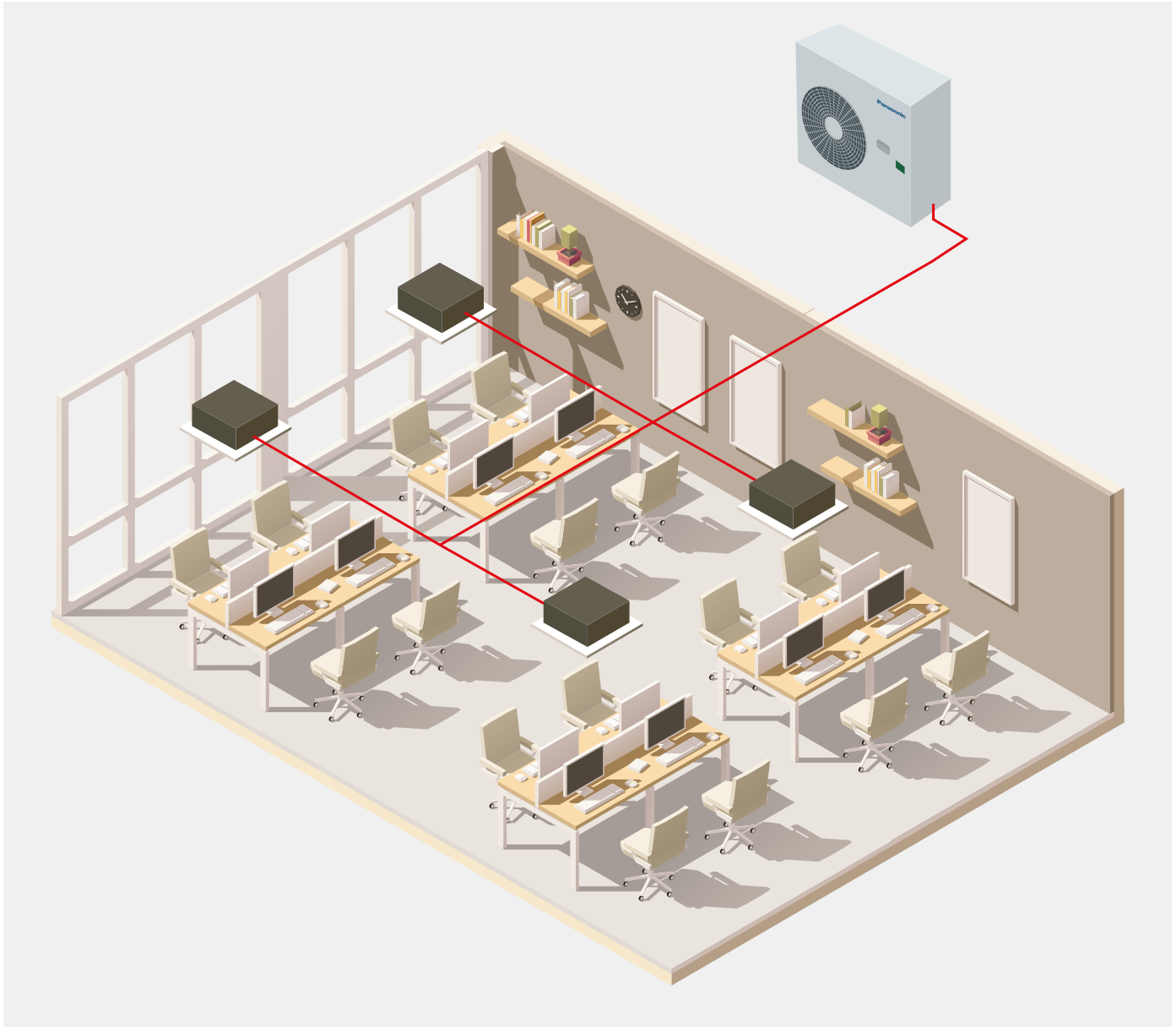

### 1 PACi NX Elite from 5,0 to 14,0 kW

Up to 4 indoor units can be connected to the same outdoor unit. Panasonic's Elite units 5,0, 7,1, 10,0, 12,0 and 14,0 can be installed as twin, triple and double-twin systems. The indoor units can be combined as per the selection table. The operation will always be simultaneous. All the indoor units will work with the same settings.

### 2 PACi NX Standard from 10,0 to 14,0 kW

Up to 2 indoor units connectable on the same outdoor. Panasonic's Standard units can be installed as single and twin systems. The indoor units can be combined following the selection table. The operation will always be simultaneous. All the indoor units will work with the same settings.

### 3 Big PACi NX from 20,0 to 25,0 kW

Up to 4 indoor units can be connected to the same outdoor unit. Panasonic's PACi NX units 20,0 and 25,0 can be installed as twin, triple and double-twin systems. The indoor units can be combined as per the selection table. The operation will always be simultaneous. All the indoor units will work with the same settings.

# Commercial twin, triple and double-twin systems - R32



## PACi NX Elite outdoor units - R32

			PACi NX				Big PACi NX		
			5,0 kW	7,1 kW	10,0 kW	12,5 kW	14,0 kW	20,0 kW	25,0 kW
<b>Outdoor unit single phase</b>			U-50PZH3E5	U-71PZH4E5	U-100PZH4E5	U-125PZH4E5	U-140PZH4E5	—	—
<b>Outdoor unit three phase</b>			—	U-71PZH4E8	U-100PZH4E8	U-125PZH4E8	U-140PZH4E8	U-200PZH4E8	U-250PZH4E8
Cooling capacity <sup>1)</sup>	Nominal (Min - Max)	kW	5,0 (1,2 - 5,6)	7,1 (2,2 - 9,0)	9,5 (3,1 - 12,5)	12,5 (3,2 - 14,0)	13,4 (3,3 - 16,0)	19,0 (5,7 - 20,0)	22,0 (6,1 - 25,6)
Heating capacity <sup>1)</sup>	Nominal (Min - Max)	kW	5,6 (1,2 - 6,5)	8,0 (2,0 - 9,0)	11,2 (3,1 - 14,0)	14,0 (3,2 - 16,0)	16,0 (3,3 - 18,0)	22,4 (5,0 - 24,5)	24,0 (5,5 - 27,6)
Power supply	Single phase	V	220 - 230 - 240	220 - 230 - 240	220 - 230 - 240	220 - 230 - 240	220 - 230 - 240	—	—
	Three phase	V	—	380 - 400 - 415	380 - 400 - 415	380 - 400 - 415	380 - 400 - 415	380 - 400 - 415	380 - 400 - 415
Connection indoor / outdoor		mm <sup>2</sup>	2x1,5 or 2,5	2x1,5 or 2,5	2x1,5 or 2,5	2x1,5 or 2,5	2x1,5 or 2,5	—	—
Air flow	Cool / Heat	m <sup>3</sup> /min	42,0/42,0	62,0/66,0	76,0/70,0	86,0/78,0	89,0/83,0	164/164	160/160
Sound pressure	Cool / Heat (Hi)	dB(A)	46/48	48/50	52/52	55/55	56/56	59/61	59/63
Sound power	Cool / Heat (Hi)	dB(A)	64/67	65/67	69/69	73/73	74/74	77/79	78/82
Dimension	H x W x D	mm	695 x 875 x 320	996 x 980 x 370	996 x 980 x 370	996 x 980 x 370	996 x 980 x 370	996 x 1140 x 460	996 x 1140 x 460
Net weight	1ph / 3ph	kg	42	66	84/82	86/84	86/84	109	109
Piping diameter	Liquid	Inch (mm)	1/4 (6,35)	3/8 (9,52)	3/8 (9,52)	3/8 (9,52)	3/8 (9,52)	1/2 (12,70)	1/2 (12,70)
	Gas	Inch (mm)	1/2 (12,70)	5/8 (15,88)	5/8 (15,88)	5/8 (15,88)	5/8 (15,88)	7/8 (22,22)	7/8 (22,22)
Pipe length range	Min - Max	m	3 - 40	5 - 60	5 - 100	5 - 100	5 - 100	5 - 100	5 - 100
Elevation difference (in / out)	Max	m	15/30	15/30 <sup>2)</sup>	15/30 <sup>2)</sup>	15/30 <sup>2)</sup>	15/30 <sup>2)</sup>	30	30
Pre-charged pipe length		m	30	30	30	30	30	30	30
Additional gas amount		g/m	15	30	40	40	40	80	80
Refrigerant (R32) / CO <sub>2</sub> Eq.		kg / T	1,13/0,76	1,95/1,32	2,70/1,82	3,00/2,03	3,00/2,03	4,80/3,24	4,80/3,24
Operating range	Cool Min - Max	°C	-15 ~ +46	-15 ~ +52	-20 <sup>3)</sup> ~ +52	-20 <sup>3)</sup> ~ +52	-20 <sup>3)</sup> ~ +52	-15 ~ +52	-15 ~ +52
	Heat Min - Max	°C	-20 ~ +24	-20 ~ +24	-20 ~ +24	-20 ~ +24	-20 ~ +24	-20 ~ +35	-20 ~ +35

1) 5,0 kW with wall-mounted. 7,1 - 14,0 kW with 4 way 90x90 cassette. 20,0 - 25,0 kW with high static pressure hide-away. 2) Outdoor unit located lower / outdoor unit located higher. 3) Pipe length up to 30 m.



## PACi NX Standard outdoor units - R32

			10,0 kW	12,5 kW	14,0 kW
<b>Outdoor unit single phase</b>			U-100PZ3E5	U-125PZ3E5	U-140PZ3E5
<b>Outdoor unit three phase</b>			U-100PZ3E8	U-125PZ3E8	U-140PZ3E8
Cooling capacity <sup>1)</sup>	Nominal (Min - Max)	kW	10,0 (3,0 - 11,5)	12,5 (3,2 - 13,5)	14,0 (3,3 - 15,0)
Heating capacity <sup>1)</sup>	Nominal (Min - Max)	kW	10,0 (3,0 - 14,0)	12,5 (3,3 - 15,0)	14,0 (3,4 - 16,0)
Power supply	Single phase	V	220 - 230 - 240	220 - 230 - 240	220 - 230 - 240
	Three phase	V	380 - 400 - 415	380 - 400 - 415	380 - 400 - 415
Connection indoor / outdoor		mm <sup>2</sup>	2x1,5 or 2,5	2x1,5 or 2,5	2x1,5 or 2,5
Air flow	Cool / Heat	m <sup>3</sup> /min	73,0/73,0	82,0/80,0	84,0/82,0
Sound pressure	Cool / Heat (Hi)	dB(A)	52/52	55/55	56/56
Sound power	Cool / Heat (Hi)	dB(A)	70/70	73/73	74/74
Dimension	H x W x D	mm	996 x 980 x 370	996 x 980 x 370	996 x 980 x 370
Net weight		kg	83	87	87
Piping diameter	Liquid	Inch (mm)	3/8 (9,52)	3/8 (9,52)	3/8 (9,52)
	Gas	Inch (mm)	5/8 (15,88)	5/8 (15,88)	5/8 (15,88)
Pipe length range	Min - Max	m	5 - 50	5 - 50	5 - 50
Elevation difference (in / out) <sup>2)</sup>	Max	m	15/30	15/30	15/30
Pre-charged pipe length		m	30	30	30
Additional gas amount		g/m	45	45	45
Refrigerant (R32) / CO <sub>2</sub> Eq.		kg / T	2,4/1,62	2,8/1,89	2,8/1,89
Operating range	Cool Min - Max	°C	-10 ~ +43	-10 ~ +43	-10 ~ +43
	Heat Min - Max	°C	-15 ~ 24	-15 ~ 24	-15 ~ 24

1) With 4 way 90x90 cassette. 2) Outdoor unit located lower / outdoor unit located higher.



Compatible indoor units for multi combinations

Optional:



Wall-mounted - PK4	Indoor unit	Cooling capacity	Heating capacity	Dimension HxWxD mm	Sound pressure <sup>1)</sup>	Air flow <sup>2)</sup>
		kW	kW		Hi / Med / Lo dB(A)	Hi / Med / Lo m <sup>3</sup> /min
		2,5 - 5,0	2,5 - 5,0		2,8 - 5,6	290x765x214
6,0 - 7,1	S-5010PK4E	6,1 - 7,1	6,1 - 7,8	295x1060x249	47/44/40 - 47/44/40	21,0/19,0/16,5 - 21,0/19,0/16,5
10,0	S-5010PK4E	9,5	9,5	295x1060x249	49/45/41	22,5/20,0/17,5



Panel (sold separately). CZ-KPY4

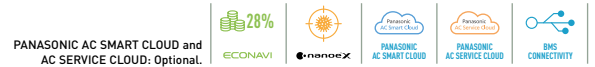

4 way 60x60 cassette - PY3	Indoor unit (panel CZ-KPY4)	Cooling capacity	Heating capacity	Dimension indoor / panel HxWxD mm	Sound pressure <sup>1)</sup>	Air flow <sup>2)</sup>
		kW	kW		Hi / Med / Lo dB(A)	Hi / Med / Lo m <sup>3</sup> /min
		2,5	S-25PY3E		2,5	3,2
3,6	S-36PY3E	3,6	4,0	243x575x575 / 30x625x625	34/30/25	9,5/7,5/6,0
5,0	S-50PY3E	5,0	5,6	243x575x575 / 30x625x625	39/34/27	12,0/9,5/6,5
6,0	S-60PY3E	6,0	7,0	243x575x575 / 30x625x625	43/37/31	14,0/10,5/8,0



Panels (sold separately):

Standard, white (RAL9003). CZ-KPU3



Econavi, white (RAL9003). CZ-KPU3A



Standard, graphite black (RAL9011). CZ-KPU3B



4 way 90x90 cassette - PU3	Indoor unit (panels CZ-KPU3 / CZ-KPU3B / CZ-KPU3A)	Cooling capacity	Heating capacity	Dimension indoor / panel HxWxD mm	Sound pressure <sup>1)</sup>	Air flow <sup>2)</sup>
		kW	kW		Hi / Med / Lo dB(A)	Hi / Med / Lo m <sup>3</sup> /min
		3,6 - 5,0	S-3650PU3E		3,6 - 5,0	4,0 - 5,6
6,0 - 7,1	S-6071PU3E	6,0 - 7,1	7,0 - 8,0	256x840x840 / 33,5x950x950	36/31/28 - 37/31/28	21,0/16,0/13,0 - 22,0/16,0/13,0
10,0 - 12,5	S-1014PU3E	10,0 - 12,5	11,2 - 14,0	319x840x840 / 33,5x950x950	45/38/32 - 46/39/33	36,0/26,0/18,0 - 37,0/27,0/19,0
14,0	S-1014PU3E	14,0	16,0	319x840x840 / 33,5x950x950	47/40/34	38,0/29,0/20,0



Ceiling - PT3	Indoor unit	Cooling capacity	Heating capacity	Dimension HxWxD mm	Sound pressure <sup>1)</sup>	Air flow <sup>2)</sup>
		kW	kW		Hi / Med / Lo dB(A)	Hi / Med / Lo m <sup>3</sup> /min
		3,6 - 5,0	S-3650PT3E		3,5 - 5,0	4,0 - 5,6
6,0 - 7,1	S-6071PT3E	6,0 - 6,8	7,0 - 8,0	235x1275x690	38/34/29 - 39/35/30	20,0/17,0/14,5 - 21,0/18,0/15,5
10,0 - 12,5	S-1014PT3E	9,5 - 12,1	11,2 - 14,0	235x1590x690	42/37/34 - 46/40/35	30,0/25,0/23,0 - 34,0/28,0/24,0
14,0	S-1014PT3E	13,4	16,0	235x1590x690	47/41/36	35,0/29,0/25,0



Adaptive ducted unit - PF3	Indoor unit	Cooling capacity	Heating capacity	Dimension HxWxD mm	External static pressure	Sound pressure <sup>1)</sup>	Air flow <sup>2)</sup>
		kW	kW		Nominal (Min - Max) Pa	Hi / Med / Lo dB(A)	Hi / Med / Lo m <sup>3</sup> /min
		3,6 - 5,0	S-3650PF3E		3,6 - 5,0	4,0 - 5,6	250x800x730
6,0 - 7,1	S-6071PF3E	5,7 - 6,8	7,0 - 7,5	250x1000x730	30(10-150) - 30(10-150)	30/26/23 - 30/26/23	21,0/19,0/15,0 - 21,0/19,0/15,0
10,0 - 12,5	S-1014PF3E	9,5 - 12,1	10,8 - 13,5	250x1400x730	40(10-150) - 50(10-150)	33/29/25 - 35/31/27	32,0/26,0/21,0 - 34,0/29,0/23,0
14,0	S-1014PF3E	13,4	15,5	250x1400x730	50(10-150)	39/35/29	36,0/32,0/25,0

\* The data shown in these tables are based on PACi NX Elite combinations. 1) The sound pressure is measured in accordance with Eurovent 6/C/006-97 specification. 2) Factory setting.

# Simultaneous operation system combinations

## PACi NX Elite from 5,0 to 14,0 kW simultaneous operation system combinations - R32

Capacity	Indoor	Outdoor				
		5,0 kW	7,1 kW	10,0 kW	12,5 kW	14,0 kW
2,5 kW	S-25PY3E S-2545PK4E	Twin U-50 (2x 2,5)	Triple U-71 (3x 2,5)	Double-twin U-100 (2x 2,5)		
3,6 kW	S-36PY3E S-3650PF3E S-2545PK4E S-3650PT3E S-3650PU3E		Twin U-71 (2x 3,6)	Triple U-100 (3x 3,6)	Double-twin U-125 (2x 3,6)	
4,5 kW	S-3650PF3E S-2545PK4E S-3650PT3E S-3650PU3E				Triple U-125 (3x 4,5)	
5,0 kW	S-50PY3E S-3650PF3E S-2545PK4E S-3650PT3E S-3650PU3E			Twin U-100 (2x 5,0)		Triple U-140 (3x 5,0)
6,0 kW	S-60PY3E S-6071PF3E S-5010PK4E S-6071PT3E S-6071PU3E				Twin U-125 (2x 6,0)	
7,1 kW	S-6071PF3E S-5010PK4E S-6071PT3E S-6071PU3E					Twin U-140 (2x 7,1)

## PACi NX Standard from 10,0 to 14,0 kW simultaneous operation system combinations - R32

Capacity	Indoor	Outdoor		
		10,0 kW	12,5 kW	14,0 kW
5,0 kW	S-50PY3E S-3650PF3E S-2545PK4E S-3650PT3E S-3650PU3E	Twin U-100 (2x 5,0)		
6,0 kW	S-60PY3E S-6071PF3E S-5010PK4E S-6071PT3E S-6071PU3E		Twin U-125 (2x 6,0)	
7,1 kW	S-6071PF3E S-5010PK4E S-6071PT3E S-6071PU3E			Twin U-140 (2x 7,1)

## Big PACi NX Elite from 20,0 to 25,0 kW simultaneous operation system combinations - R32

Capacity	Indoor	Outdoor	
		20,0 kW	25,0 kW
5,0 kW	S-3650PF3E S-5010PK4E S-3650PU3E	Double-twin U-200 (2x 5,0)	
6,0 kW	S-3650PF3E S-5010PK4E S-3650PU3E		Double-twin U-250 (2x 6,0)
7,1 kW	S-3650PF3E S-5010PK4E S-3650PU3E	Triple U-200 (3x 7,1)	
10,0 kW	S-3650PF3E S-5010PK4E S-3650PU3E	Twin U-200 (2x 10,0)	
12,5 kW	S-1014PF3E S-1014PU3E		Twin U-250 (2x 12,5)



# Refrigerant piping arrangements

Single

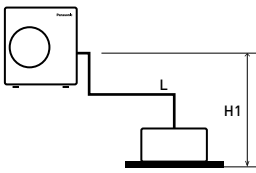

Twin

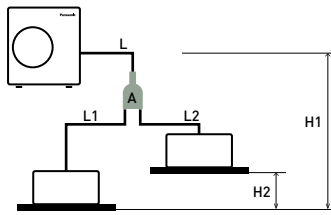

Triple

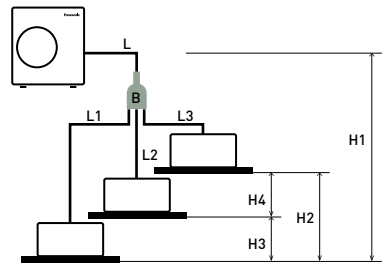

Double-twin

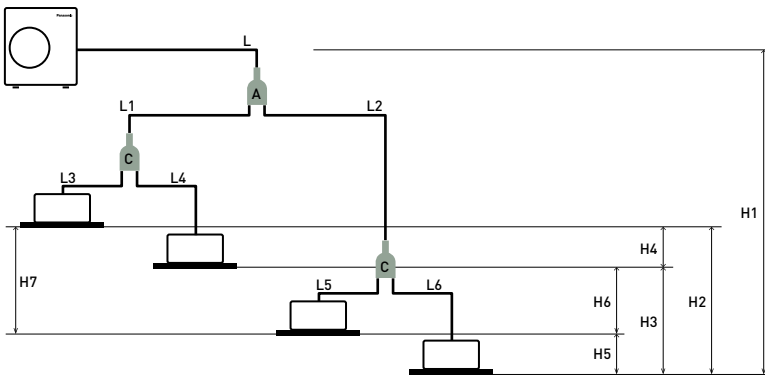

**PACi NX Elite twin, triple and double-twin system from 5,0 to 14,0 kW**

Joint distribution (sold separately)  
 A= CZ-P224BK2BM  
 B= CZ-P3 HPC2BM  
 C= CZ-P224BK2BM

**PACi NX Standard twin system from 10,0 to 14,0 kW**

Joint distribution (sold separately)  
 A= CZ-P224BK2BM

**Big PACi NX twin, triple and double-twin system from 20,0 to 25,0 kW**

Joint distribution (sold separately)  
 A= CZ-P680BK2BM  
 B= CZ-P3 HPC2BM  
 C= CZ-P224BK2BM

Twin System	PACi NX Standard single and twin system from 7,1 to 14,0 kW		PACi NX Elite twin, triple and double-twin system from 5,0 to 25,0 kW				Equivalent lengths and height differences (m) for outdoor unit sizes from 5,0 to 14,0 kW	Equivalent lengths and height differences (m) for outdoor unit sizes from 20,0 to 25,0 kW
	Indoor unit combinations (see examples above)		Indoor unit combinations (see examples above)					
	Single	Twin	Single	Twin	Triple	Double-Twin		
Total pipe length	L	L + L1 + L2 ≤ 50 m	L	L + L1 + L2	L + L1 + L2 + L3	L + L1 + L2 + L3 + L4 + L5 + L6	U-50/60: 40 m U-71: 60 m U-100/125/140: ≤ 100 m	U-200/250: ≤ 100 m
Maximum pipe length from outdoor unit to most distant indoor unit	-	-	-	L + L1 or L + L2	L + L1 or L + L2 or L + L3	L + L1 + L3 or L + L1 + L4 or L + L2 + L5 or L + L2 + L6	-	U-200: 90 m U-250: 60 m
Maximum branch pipe length	-	L1 L2 ≤ 15	-	L1 or L2	L1 or L2 or L3	L1 + L3 or L1 + L4 or L2 + L5 or L2 + L6	≤ 15 m	≤ 20 m
Maximum branch pipe length differences	-	L1 > L2 L1 - L2 ≤ 10	-	L1 > L2; L1 - L2	L1 > L2 > L3: L1 - L2 L2 - L3 L1 - L3	L2 + L6 (Max.) L1 + L3 (Min.): (L2 + L6) - (L1 + L3)	≤ 10 m	≤ 10 m
Maximum pipe length differences after first branch (Double-Twin)	-	-	-	-	-	L2 > L1: L2 - L1	≤ 10 m	≤ 10 m
Maximum pipe length differences after second branch (Double-Twin)	-	-	-	-	-	L4 > L3: L4 - L3 L6 > L5: L6 - L5	≤ 10 m	≤ 10 m
Height difference (outdoor unit located higher)	H1	H1 ≤ 30	H1	H1	H1	H1	≤ 30 m	≤ 30 m
Height difference (outdoor unit located lower)	H1	H1 ≤ 15	H1	H1	H1	H1	≤ 15 m	≤ 15 m
Height difference between indoor units	-	H2 ≤ 0,5	-	H2	H2 or H3 or H4	H2 or H3 or H4 or H5 or H6	≤ 0,5 m	≤ 0,5 m

Make additional charges by adding up tube length in an order of main tube (L) > branch tube (L1 > L2 > L3 wide diameter) and then selecting the amount of refrigerant corresponding to the remaining (after charge-less tube length: 30 m) liquid tube diameter and tube length from the above table.  
 For pipe sizes and refrigerant charge, please refer to the technical instructions or design software.

## PACi NX with Water Heat Exchanger for chilled and hot water production

A highly-efficient Water Heat Exchanger for PACi NX Series.  
This ground-breaking product provides further possibilities by adding hydronic options.

Water outlet  
temperature:  
Cooling: 5 ~ 15 °C  
Heating: 30 ~ 55 °C

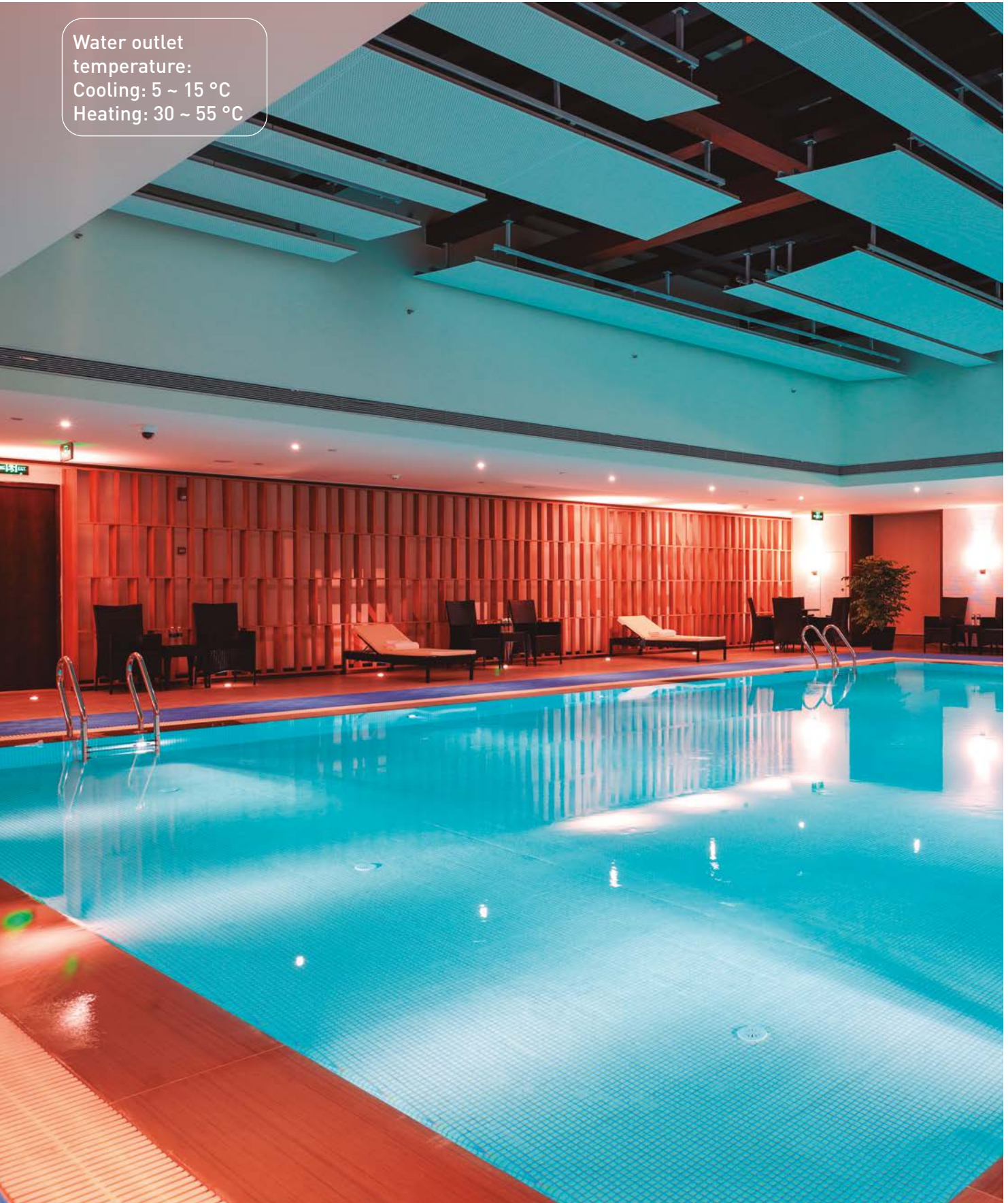

## Highly-efficient Water Heat Exchanger for PACi NX Series.

### System example.

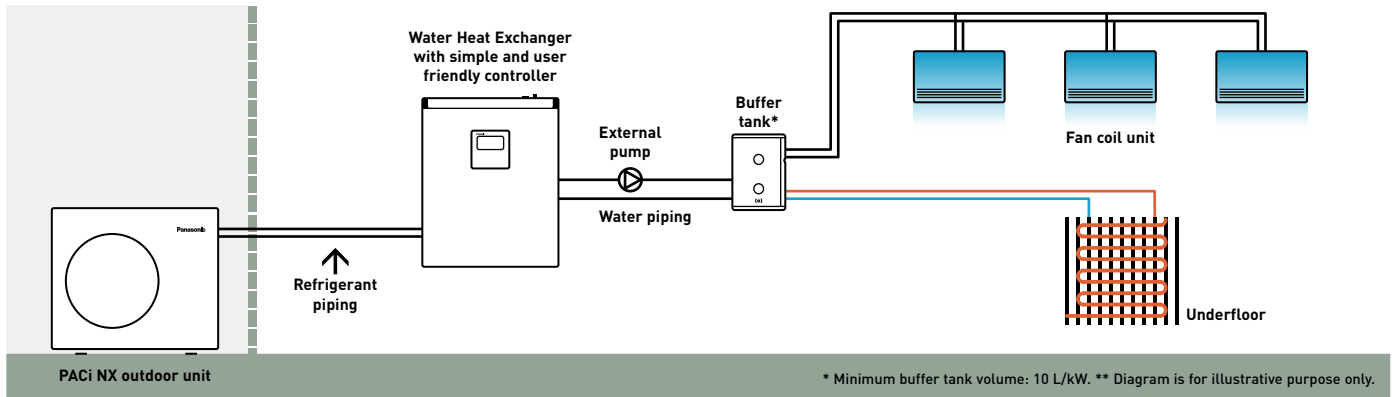

### 1 Cost saving solution

- A+++ Energy efficiency class (scale from A+++ to D)
- Cost effective water projects thanks to lower cost for PACi NX compared to VRF
- Reducing the amount of HFC refrigeration in the project

### 2 Flexible and space saving system

- 2 installation possibilities (wall-mounted / floor-standing)
- Compact, lightweight unit design, only 27 kg

### 3 Easy installation, maintenance

- Quick mounting process
- Flow switch kit is included as a standard
- Direct access to electrical box
- Operation down to -20 °C ambient without the need for glycol

### Flexible and space saving system

#### Compact and light unit.

- Only 205 mm depth fits within a limited space
- Lightweight design at only 27 kg, makes it easy to maneuver and position
- Maximum total refrigerant piping length: 100 m

#### 2 installation options.

- Wall-mounted and floor-standing installation options are available. Free-up floor space by using the wall-mounted installation
- Quick mounting process with its lightweight compact design  
Make fixing holes > Fix 2 screws > Hang the unit > Finish

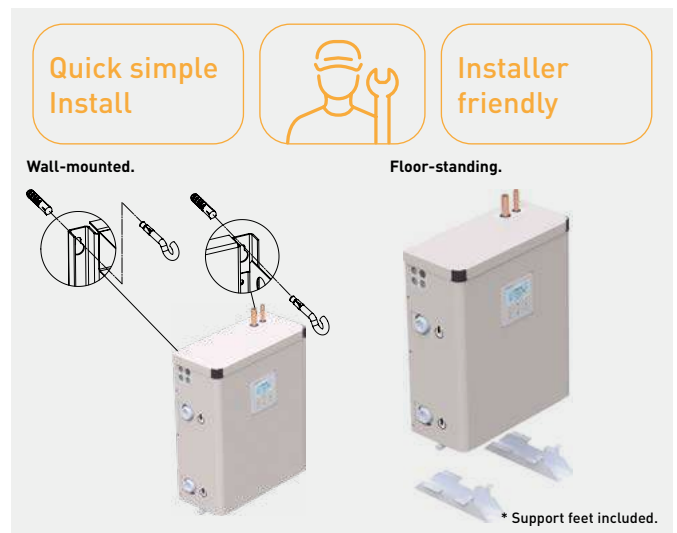

### Foodchain/Small office application

- Fulfilling R32 refrigerant needs to follow environmental perspective, Company policy
- Hydraulic system to reduce total amount of HFC refrigeration
- Water solution to substitute electric heating system



Foodchain.

### Residential/Commercial retail application

- Water solution to substitute existing boiler system
- For heating projects with longer than 50 m piping



Commercial retail.

PACi NX Water Heat Exchanger (WHE) is the ideal solution for residential and commercial applications; the investment costs can be amortised in a short period.

Easy maintenance operation from two points of access

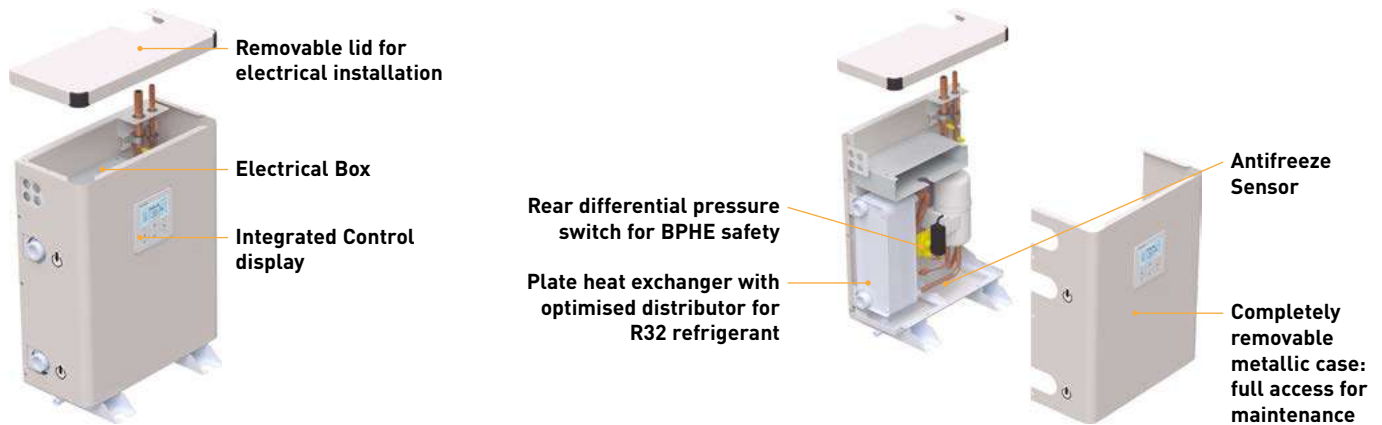

Integrated cascade control as standard for maximum ease and flexibility

Built-in cascade control for 2 units.

The control of 2 refrigerant systems can be combined together in a cascade. This option is included in the standard scope of delivery on the WHE. It is activated using the one of the CZ-RTC5B remote controllers on the units as master. Rotation and Backup operation modes can be selected.

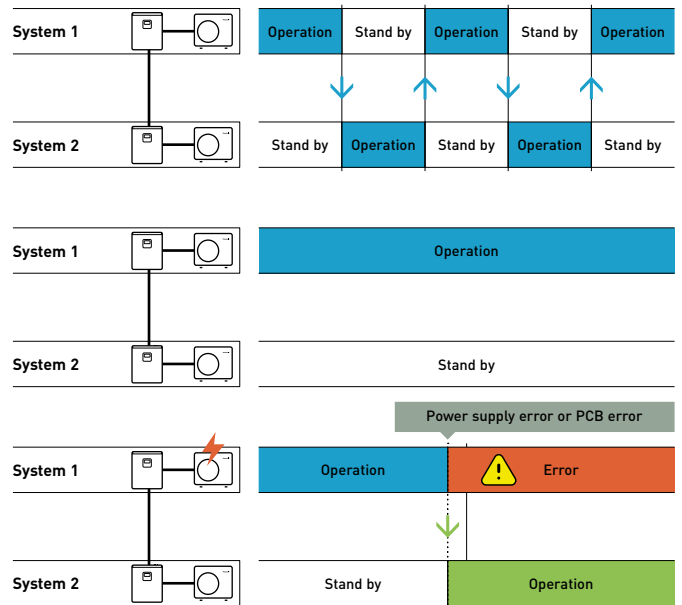
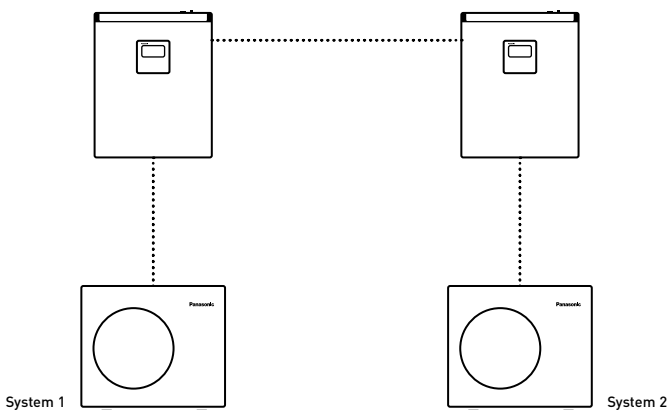

\* One of built-in controllers should be deactivated.

PACi NX Water Heat Exchanger can be connected as a cascade with up to 4 groups of 8 units, reaching up to 800 kW

Optional PAW-PACR4 cascade controller allows up to four groups, with each group containing between 1-8 units, to be combined into a cascade for failure substitution or temperature assist.

- Maximum 4 groups (up to 8 units per group)
- Rotation
- Failure substitution
- Temperature assist
- Operation output signal
- Alarm output signal

Example: 4 x groups.  
 Maximum available capacity per group: 8 x 25 kW = 200 kW.  
 Total maximum available capacity: 4 x 200 kW = 800 kW.

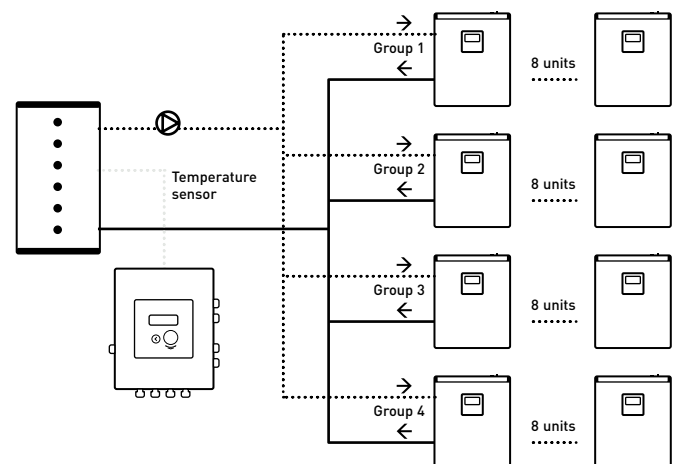

## PACi NX with Water Heat Exchanger for chilled and hot water production

Hydronic solution with PACi NX for a quick return on investment.  
Constant 55 °C flow available.

### Short-term investment recovery.

PACi NX Water Heat Exchanger is ideal for small offices and retails. The investment costs can be amortised within a very short period. This solution allows investors and operators to save money.



Model			PAW-200W5APAC-2	PAW-250W5APAC-2
Cooling capacity <sup>1)</sup>		kW	17,92	22,98
EER <sup>1)</sup>		W/W	2,95	2,65
Heating capacity <sup>2)</sup>		kW	23,06	26,00
COP <sup>2)</sup>		W/W	3,69	3,47
Energy efficiency class (Scale A+++ to D) <sup>3)</sup>	35 °C (low temperature HP)		A+++	A+++
	55 °C (low temperature HP)		A++	A+
$\eta_{s,h}$ (LOT1) <sup>4)</sup>			179,8%	176,5%
Dimension	HxWxD	mm	550x455x205	550x455x205
Net weight		kg	27	27
Water pipe connector		Inch	Male Thread 1 ¼	Male Thread 1 ¼
Cooling water flow ( $\Delta T=5$ K, 35 °C)		m <sup>3</sup> /h	3,45	4,30
Heating water flow ( $\Delta T=5$ K, 35 °C)		m <sup>3</sup> /h	4,15	4,85
Flow switch			Included	Included
Water filter			Included	Included
<b>Outdoor unit</b>			<b>U-200PZH4E8</b>	<b>U-250PZH4E8</b>
Sound pressure	Cool / Heat (Hi)	dB(A)	57/61	57/63
Dimension <sup>5)</sup>	HxWxD	mm	996x1140x460	996x1140x460
Net weight		kg	109	109
Piping diameter	Liquid	Inch (mm)	1/2(12,70)	1/2(12,70)
	Gas	Inch (mm)	7/8(22,20)	7/8(22,20)
Pipe length range		m	5 ~ 100	5 ~ 60
Elevation difference (in / out)		m	30	30
Pre-charged pipe length		m	30	30
Additional gas amount		g/m	80	80
Water outlet temperature range	Cool Min ~ Max	°C	+5 ~ +15	+5 ~ +15
	Heat Min ~ Max	°C	+30 ~ +55	+30 ~ +55
Operating range	Cool Min ~ Max	°C	-15 ~ +52	-15 ~ +52
	Heat Min ~ Max	°C	-20 ~ +35	-20 ~ +35

1) Data refers to 7 °C leaving chilled water temperature and 35 °C ambient air temperature, according to EN 14511 standard. 2) Data refers to 35 °C leaving warm water temperature and 7 °C ambient air temperature according to EN 14511 standard. 3) Following COMMISSION REGULATION (EU) No 811/2013 for low-temperature heat pumps. Scale from A+++ to D. 4) Following COMMISSION REGULATION (EU) No 813/2013 for low-temperature heat pumps. 5) Add 100 mm for indoor unit or 70 mm for outdoor unit for piping port.

## Professional solution

Many air conditioning manufacturers are selling R32 systems and it is becoming the standard refrigerant for split type air conditioning, because R32 has a much lower global warming potential than R410A, and can also provide higher efficiency.

### Quick installation with pre-assembled flow switch

The flow switches come pre-assembled with pipe fittings for ease of installation.

Operation down to -20 °C with no glycol as the heat exchanger is installed indoors.

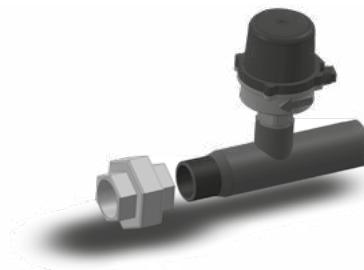

**AHU connection kit PAH3M-1 for PACi NX**

CONEX Bluetooth® version (CZ-RTC6BL) is built-in.  
Easy connection and set-up is possible via Bluetooth®.  
0-10 V demand control.



PACi



PAW-280PAH3M-1			2,5 kW	3,6 kW	5,0 kW	6,0 kW	7,5 kW	10,0 kW	12,5 kW	14,0 kW	20,0 kW	25,0 kW
Dimension	HxWxD	mm	500 x 400 x 150	500 x 400 x 150	500 x 400 x 150	500 x 400 x 150	500 x 400 x 150	500 x 400 x 150	500 x 400 x 150	500 x 400 x 150	500 x 400 x 150	500 x 400 x 150
Net weight		kg	11,5	11,5	11,5	11,5	11,5	11,5	11,5	11,5	11,5	11,5
Piping diameter	Liquid	Inch (mm)	1/4 (6,35)	1/4 (6,35)	1/4 (6,35)	3/8 (9,52)	3/8 (9,52)	3/8 (9,52)	3/8 (9,52)	3/8 (9,52)	3/8 (9,52)	1/2 (12,70)
	Gas	Inch (mm)	1/2 (12,70)	1/2 (12,70)	1/2 (12,70)	5/8 (15,88)	5/8 (15,88)	5/8 (15,88)	5/8 (15,88)	5/8 (15,88)	1 (25,40)	1 (25,40)
Intake temperature of AHU connection kit	Cool Min ~ Max	°C DB	18 ~ 32	18 ~ 32	18 ~ 32	18 ~ 32	18 ~ 32	18 ~ 32	18 ~ 32	18 ~ 32	18 ~ 32	18 ~ 32
	Cool Min ~ Max	°C WB	14 ~ 25	14 ~ 25	14 ~ 25	14 ~ 25	14 ~ 25	14 ~ 25	14 ~ 25	14 ~ 25	—	—
	Heat Min ~ Max	°C	16 ~ 30	16 ~ 30	16 ~ 30	16 ~ 30	16 ~ 30	16 ~ 30	16 ~ 30	16 ~ 30	16 ~ 30	16 ~ 30
<b>With PACi NX Elite</b>												
Cooling capacity		kW	—	3,6	5,0	6,0	7,1	10,0	12,5	14,0	19,0	22,0
Heating capacity		kW	—	4,0	5,6	7,0	8,0	11,2	14,0	16,0	22,4	24,0
Air flow	Min / Max	m³/h	—	540/870	630/990	780/1320	780/1320	900/2160	1140/2280	1200/2400	2160/8000	2160/9000
Pipe length range		m	—	3 ~ 40	3 ~ 40	3 ~ 40	5 ~ 50	5 ~ 85	5 ~ 85	5 ~ 85	5 ~ 100	5 ~ 100
Elevation difference (in / out)	Max	m	—	30	30	30	30	30	30	30	30	30
Ambient temperature of outdoor unit	Cool Min ~ Max	°C	—	-15 ~ +46	-15 ~ +46	-15 ~ +46	-15 ~ +46	-20 ~ +48	-20 ~ +48	-20 ~ +48	-15 ~ +52	-15 ~ +52
	Heat Min ~ Max	°C	—	-20 ~ +24	-20 ~ +24	-20 ~ +24	-20 ~ +24	-20 ~ +24	-20 ~ +24	-20 ~ +24	-20 ~ +35	-20 ~ +35
<b>With PACi NX Standard</b>												
Cooling capacity		kW	2,5	3,6	5,0	6,0	7,1	10,0	12,5	14,0	—	—
Heating capacity		kW	3,2	4,0	5,0	6,0	7,1	10,0	12,5	14,0	—	—
Air flow	Min / Max	m³/h	360 / 570	540/870	630/990	780/1320	780/1320	900/2160	1140/2280	1200/2400	—	—
Pipe length range		m	3 ~ 15	3 ~ 15	3 ~ 20	3 ~ 40	3 ~ 40	5 ~ 50	5 ~ 50	5 ~ 50	—	—
Elevation difference (in / out)	Max	m	30	30	30	30	30	30	30	30	—	—
Ambient temperature of outdoor unit	Cool Min ~ Max	°C	-10 ~ +43	-10 ~ +43	-10 ~ +43	-10 ~ +43	-10 ~ +43	-10 ~ +43	-10 ~ +43	-10 ~ +43	—	—
	Heat Min ~ Max	°C	-15 ~ +24	-15 ~ +24	-15 ~ +24	-15 ~ +24	-15 ~ +24	-15 ~ +24	-15 ~ +24	-15 ~ +24	—	—

**Control options**

**Control option 1.**

- The system's control is simple: control of actual suction temperature vs. set point
- Control works in the same way as that of any indoor unit
- Fan signal issued by the PCB (OFF while defrosting, for instance)

**Control option 2.**

- System control by a 0-10 V control working from an external BMS that manages the set point for temperature or capacity. Enhances efficiency by adjusting capacity and enhances comfort as well
- All signals as standard

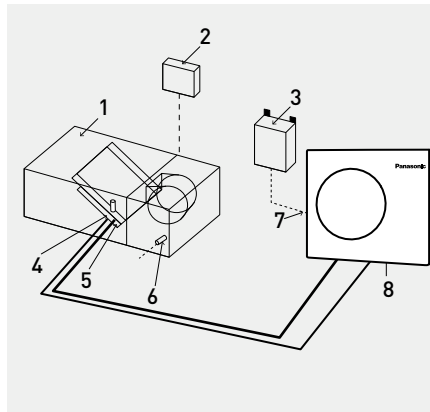

**System and regulations. System overview.**

- 1 | AHU equipment (field supplied)
- 2 | AHU system controller (field supplied)
- 3 | AHU connection kit controller box (with control PCB)
- 4 | Thermistor for gas pipe (E2)
- 5 | Thermistor for liquid pipe (E1)
- 6 | Thermistor for suction air
- 7 | Inter-unit wiring
- 8 | Outdoor unit

**0-10 V control**

With the 0-10 V demand control the capacity of the outdoor unit can be controlled by 20 steps.

Input voltage* [V]	0	1,0	1,5	2,0	2,5	3,0	3,5	4,0	4,5	5,0	5,5	6,0	6,5	7,0	7,5	8,0	8,5	9,0	9,5
Demand [% of nominal current]	No cut <sup>1)</sup>	40	45	50	55	60	65	70	75	80	85	90	95	100	105	110	115	120	No limit / Full capacity <sup>2)</sup>
Indoor unit start / stop	Stop <sup>1)</sup>																		Start

1) No cut / stop: AHU system / indoor unit is completely switched OFF.

2) No limit: No restrictions applied by BMS to AHU system / indoor unit performance (equivalent to "full-load operation" of AHU system / indoor unit).

**AHU connection kit.**

PCB, power trans, terminal block.



Thermistor x2 (refrigerant: E1, E2).



Thermistor (air: TA; 1 sensor).



Wired remote controller. CZ-RTC6BL.



**Optional controller.**

Timer remote controller. CZ-RTC5B.



**Electric air curtain**

The Panasonic range of air curtains is designed for smooth operation and efficient performance. Air curtains produce a continuous stream of air blown from the top to the bottom of an open doorway and create a barrier that people and products can flow across, but air cannot.



Model			FY-3009U1	FY-3012U1	FY-3015U1
Width	mm		900	1200	1500
Voltage	V		220	220	220
Air flow	Hi / Lo	m <sup>3</sup> /h	1100/920	1400/1270	2000/1800
Consumption	Hi / Lo	W	76/70	94/85	131/110
Current	Hi / Lo	A	0,35/0,32	0,43/0,40	0,59/0,50
Air speed	Hi / Lo	m/s	10,50/8,50	9,50/8,00	10,50/9,50
Sound pressure	Hi / Lo	dB(A)	48,5/45,0	48,5/44,5	51,5/48,0
Dimension	HxWxD	mm	900x231,5x212	1200x231,5x212	1500x231,5x212
Net weight		kg	12,0	14,5	18,0

**1 Designed to maximize performance**  
High air flow upgraded 145% compared to conventional model (in the case of FY-3009U1).

**3 Easier installation and maintenance**  
Simple structure for easy installation and maintenance.

**2 Comprehensive product line up**  
1,5 m wide model added in the line up.

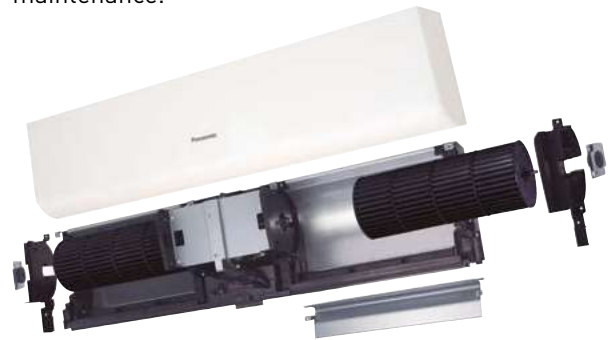

## Air curtain with DX coil, connected to PACi NX

**Comfort:** Easy redirection of air flow by means of manual deflector.

**Ease of use:** Speed selector (high and low) on the unit itself.

**Easy installation and maintenance:** Easy installation / Compact dimensions improve installation and positioning / Easy cleaning of grid without opening of the unit.



Outdoor unit capacity			7,1 kW	10,0 kW	14,0 kW	20,0 kW
Air outlet height 2,7 m			PAW-10PAIRC-LS-1	PAW-15PAIRC-LS-1	PAW-20PAIRC-LS-1	PAW-25PAIRC-LS-1
Cooling capacity <sup>1)</sup>	Max	kW	6,1	9,7	13,0	17,0
Heating capacity <sup>2)</sup>	Max	kW	7,9	12,0	15,0	19,0
Air flow	High	m <sup>3</sup> /h	1800	2700	3600	4500
Heat Exchanger	Volume	L	1,67	2,85	3,94	5,03
Electric consumption fan	230 V / 50 Hz	kW	0,30	0,50	0,60	0,80
Current	230 V / 50 Hz	A	2,10	3,10	4,10	5,10
Sound pressure <sup>3)</sup>	Max	dB(A)	65	66	67	69
Air outlet height 3,0 m			PAW-10PAIRC-HS-1	PAW-15PAIRC-HS-1	PAW-20PAIRC-HS-1	PAW-25PAIRC-HS-1
Cooling capacity <sup>1)</sup>	Max	kW	9,1	13,0	19,5	23,7
Heating capacity <sup>2)</sup>	Max	kW	11,8	15,8	23,6	27,6
Air flow	High	m <sup>3</sup> /h	2700	3600	5400	6300
Heat Exchanger	Volume	L	1,67	2,85	3,94	5,12
Electric consumption fan	230 V / 50 Hz	kW	0,75	1,00	1,50	1,75
Current	230 V / 50 Hz	A	4,10	5,50	8,20	9,60
Sound pressure <sup>3)</sup>	Max	dB(A)	66	67	68	68
Common data						
Dimension <sup>4)</sup>	HxWxD	mm	260 (+140) x 1000 x 460	260 (+140) x 1500 x 460	260 (+140) x 2000 x 460	260 (+140) x 2500 x 460
Net weight	Air outlet height 2,7 m	kg	50	65	80	95
	Air outlet height 3,0 m	kg	55	65	85	110
Fan type			EC	EC	EC	EC
Piping diameter	Liquid / Gas	Inch (mm)	3/8 (9,52) / 5/8 (15,88)	3/8 (9,52) / 3/4 (19,05)	3/8 (9,52) / 7/8 (22,22)	3/8 (9,52) / 7/8 (22,22)
Door width		m	1,0	1,5	2,0	2,5
Refrigerant			R32	R32	R32	R32

LS / PACi NX outdoor combination*	PACi NX Elite			PACi NX Standard		
	40 °C	35 °C	30 °C	40 °C	35 °C	30 °C
PAW-10PAIRC-LS-1	U-100	U-100	U-50	U-100	U-100	U-60
PAW-15PAIRC-LS-1	U-200	U-100	U-100	—	U-100	U-100
PAW-20PAIRC-LS-1	U-200	U-140	U-100	—	—	U-100
PAW-25PAIRC-LS-1	U-250	U-200	U-125	—	—	U-125

HS / PACi NX outdoor combination*	PACi NX Elite			PACi NX Standard		
	40 °C	35 °C	30 °C	40 °C	35 °C	30 °C
PAW-10PAIRC-HS-1	U-200	U-100	U-100	—	U-100	U-100
PAW-15PAIRC-HS-1	U-200	U-200	U-100	—	U-200	U-100
PAW-20PAIRC-HS-1	—	U-250	U-200	—	U-250	—
PAW-25PAIRC-HS-1	—	U-250	U-200	—	U-250	—

1) Cooling capacity DX coil, air temperature in / out +27 / +18 °C, R32 and R410. 2) Heating capacity condenser, air temperature in / out +20 / +33 °C, R32 and R410. In the case of lower outdoor temperatures, an outdoor model with higher capacity may be necessary. 3) Measured in distance up to 5,0 m, direction factor 2, absorbing surfaces 200 m<sup>2</sup>, Min / Max air flow. 4) 140 mm is the height of an electrical box if it is installed on the top.

### Technical focus

- Save up to 40% energy costs by use of the integrated EC fan technology (higher efficiency than conventional AC fan, soft start and longer motor duration)
- 4 length of air curtain LS and HS are available 1,0, 1,5, 2,0 and 2,5 m
- Installation height up to 3,0 m
- Outlet grilles can be adjusted in five positions, to suite different indoor and installation requirements
- Control with Panasonic remote control systems (optional)
- Direct integration to BMS via optional Panasonic interfaces
- Drip tray included in all DX air curtains
- Drain pump optional

### How does it work?

Stale air from the room is taken in and ejected near the door. This creates a 'roll of air' that shields the door area, mixing with the colder incoming air. It then turns away from the door, back into the room and toward the intake screen, where it is partly drawn in again. This flow of air helps to create a barrier for heat loss yet at the same time refreshes room air

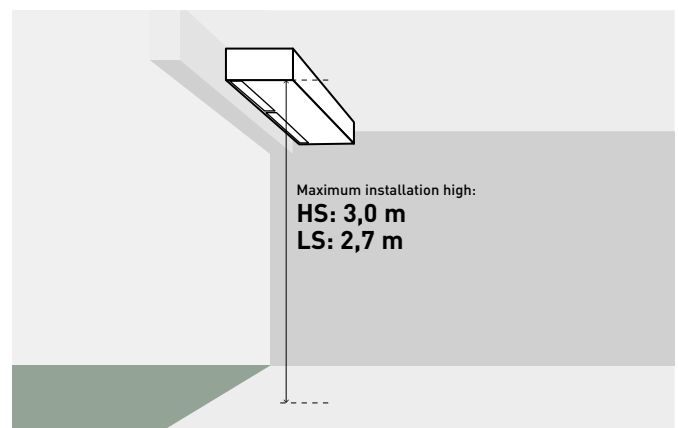



### Ceiling mounted air-e nanoe X Generator

- nanoe™ X technology  
(Generator Mark 1: 4,8 trillion hydroxyl radicals/sec)
- Silent operation. Whisper quiet at 25,5 dB(A)\*
- Low power consumption 4 W
- Easy installation
- Compact and modern design

\* 230 V.

air-e™



Model	FV-15CSD16				
Power supply	Voltage	V	220	230	240
	Frequency	Hz	50	50	50
Air flow	m³/h		15	16	17
	CFM		8,8	9,4	10,0
Consumption	W		4	4	4
Sound pressure	dB(A)		23,5	25,5	27,0
Net weight	kg			1,1	

\* The value of air volume, power consumption and noise are specified at static pressure 0 Pa. The value of air volume is the mean value and a tolerance of +-10% is allowed. The value of noise level is a weighted average sound pressure level, the mean value is measured by Panasonic. A tolerance of +3 dB/-7 dB is allowed. The noise is measure at 1 m apart from the left, the front and below of the tested product. Conditions of generating nanoe™ X: room temperature: about 5 °C ~ 40 °C (dew point temperature more than 2 °C), relative humidity: about 30% ~ 85%. nanoe™ X is generated using the air in the room, and its amount is subject to the temperature and humidity in the air.

### One device is suitable for around 20 m² (with a ceiling height 3 m)

Ex. 3 air-e devices are required for the room size 60 m².

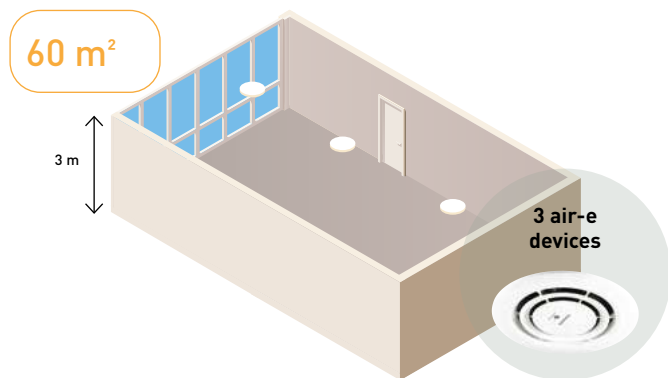

### Concentration simulator is ready

See how nanoe™ X fills space.

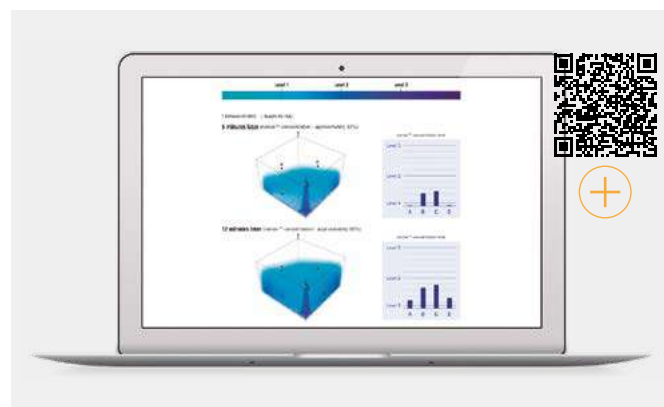

The air-e is a stand alone device which is an easy and simple choice to improve indoor air quality. It can be easily installed to various commercial projects including refurbishments.



### The tested effects of nanoe™ X

#### Bacteria and viruses.

SARS-CoV-2: 99,9% % inhibited <sup>1)</sup>

Influenza virus H1N1 subtype: 99,9 % inhibited <sup>2)</sup>

#### Odour.

nanoe X Generator can reduce cigarette smoke odour intensity by 2,4 levels in 12 minutes.

- 1) Novel coronavirus [SARS-CoV-2] > [Test organization] Texcell [France] [Test subject] Adhered novel coronavirus [SARS-CoV-2] [Test volume] 45 L enclosed box [Test result] Inhibited 99,9% in 2 hours [Test report] 1140-01 A1.
- 2) Adhered virus [Influenza virus H1N1 subtype] > [Test organization] Kitasato Research Center for Environmental Science [Test subject] Influenza virus [H1N1 subtype] [Test volume] 1000 L enclosed box [Test result] Inhibited 99,9% in 2 hours [Test report] 21\_0084\_1.
- 3) Deodorisation effect for adhering odour [cigarette smoke] > [Test organization] Panasonic Product Analysis Center [Test subject] Adhered cigarette smoke odour [Test volume] Approx. 24 m³ laboratory [Test result] Odour intensity reduced 2,4 levels in 0,2 hours [Test report] 4AA33-160615-N04.

Performance of nanoe™ X might differ in real life environment and is only expected in the same room as where the unit is placed. The nanoe™ X performance varies depending on the room size, environment and usage and it may take several hours to reach the full effect. nanoe™ X is not a medical device.

Deodorisation effect for adhering odour (cigarette smoke) <sup>3)</sup>.

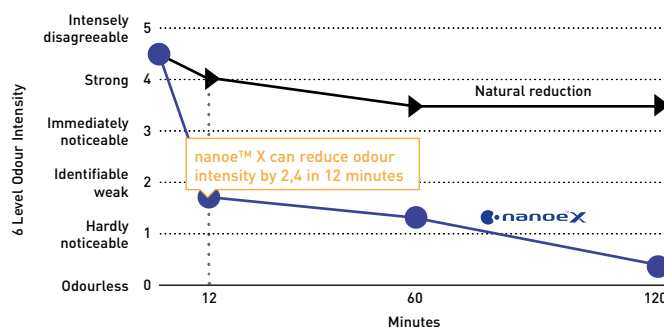

For further details and validation data, please refer to the following website.



## R22 Renewal. Fast, easy to install and cost effective

An important drive to further reduce the potential damage to our ozone.

It is often said that legislation is ruling our lives but sometimes it is there to help save lives. R22 phase out can be described as one of these and from Jan 1st 2010 the use of Virgin R22 refrigerant was banned within the European Union.



## Panasonic is doing its part.

We at Panasonic are also doing our part - recognising that all finances are under pressure at the moment. Panasonic has developed a clean and cost effective solution to enable this latest legislation to offer less financial impact on your business.

The Panasonic renewal system allows good quality existing R22 or R410A pipe work to be re-used whilst installing high efficiency R32 systems.

By bringing a simple solution to the problem Panasonic can renew all split systems and PACi NX systems; and depending upon certain restrictions we don't even limit the manufacturer's equipment we are replacing.

By installing a high efficiency Panasonic R32 system you can benefit from around 30% running cost saving compared to the R22 system.

Yes...

1. Check the capacity of the system you wish to replace
2. Select from the Panasonic range the best system to replace it with
3. Follow the procedure detailed in the brochure and technical data

Simple...

## Why renewal?

### Unique R22 Renewal from Panasonic: Fast, easy to install and cost effective.

- Panasonic refrigerant oil doesn't react to the most common oil types used in air-conditioning systems. This ensures the mix of oil does not damage the units. Therefore installations are easier

- All Panasonic PACi NX units can be installed in R22 pipings, no specific models are available
- Up to 33 Bar! When there is any doubt about the strength of the piping, the maximum working pressure can be reduced to 33 Bar with a setting in the software of the outdoor unit

## Reuse of existing piping (renewal design and installation)

### Notes on reuse of existing refrigerant piping.

It is possible for each series of PZH and PZ series outdoor unit to reuse the existing refrigerant piping without cleaning when obtained under certain conditions. Make sure that the requirements under the section "Notes on reuse of existing refrigerant piping", "Measurement procedure for renewal" and "Refrigerant piping size and allowable piping length" will be satisfied in order to carry out.

Also, check the items with regard to section "Safety" and "Cleaning".

### 1. Prerequisite.

- If the refrigerant used for the existing unit is other than R22, R407C and R410A / R32, the existing refrigerant piping cannot be used.
- If the existing unit has another use than air conditioning, then existing refrigerant piping cannot be used.

### 2. Safety.

- If there is a hollow, crack or corrosion on the piping, make sure to install new piping.
- If the existing piping is other than capable of reuse of piping as shown in the flowchart, make sure to install new piping.
- In case of multiple operation, use our genuine branch piping for refrigerant R32.

A local supplier shall assume responsibility for the defects and hollows on the reuse of existing piping surface and recognition of reliability of the piping strength. There is no guarantee that we take responsibility for such damages.

The operational pressure of the refrigerant R32 becomes higher compared to R22 or R410A. In the worst case, a lack of compressive strength may lead to piping explosion.

### 3. Cleaning.

- When the refrigerant oil used for the existing unit is other than the listed below, make sure to install new piping or wash it thoroughly before reusing it.  
[Mineral Oil] SUNISO, FIORE S, MS  
[Synthesized oil] alkyl benzene oil (HAB, parallel freeze), ester oil, ether oil (PVE only)

If the existing unit is GHP type, it is necessary to wash the piping thoroughly.

- If the existing pipes in the outdoor and indoor units remain disconnected, make sure to install a new piping or wash it thoroughly before reusing it.
- If the discoloured oil or residue remains in the existing piping, make sure to install a new piping or wash it thoroughly before reusing it. See "Deterioration Criteria for Refrigerant Oil" in table 3.
- If the compressor of the existing air conditioner has a failure history, make sure to install a new piping or wash it through thoroughly before reusing it.

When reusing the existing piping as it is without removing dirt and dust, inadequate piping could result a renewal appliance in failure.



**Notes on renewal for simultaneous operation of multiple units.**

Only main pipe is applicable for using the different diameter size.  
 In case of different diameter size for the branch pipes, a new installation work for a standard size is necessary.  
 Be sure to use our genuine branch piping for refrigerant R32.

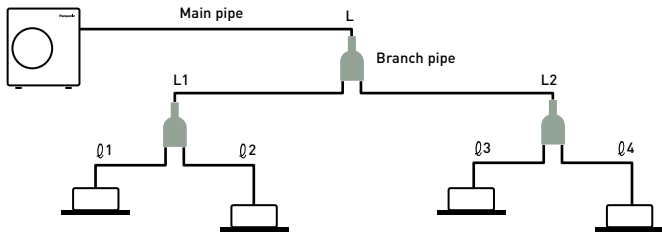

Notes on renewal for simultaneous operation of multiple units		
Capacity class	Standard liquid pipe size	Standard gas pipe size
Type 50	∅ 6,35	∅ 12,70
Type from 60 to 140	∅ 9,52	∅ 15,88
Type 200	∅ 12,70	∅ 22,22
Type 250	∅ 12,70	∅ 22,22

- Only the main pipe L can be used among different diameter's existing piping
- Installation work as a standard size is capable for L1, L2, Q1 - Q4 piping
- Be sure to use our genuine branch piping for refrigerant R32

- In case of single unit:  
 It is not necessary to charge with additional refrigerant until the chargeless pipe length in the table 2.  
 If the pipe length is exceeding the charge less pipe length, charge with additional refrigerant amount per 1 m according to the equivalent length.
- In case of simultaneous operation of multiple units:  
 Calculate the refrigerant charging amount according to the calculating method of the standard piping diameter.  
 As to the additional refrigerant charging amount per 1 m, refer to the additional amount in the table 2.

**Measurement procedure for renewal**

Observe the following procedure when reusing the existing piping or carrying out renewal installation work.  
 Flowchart of existing piping measures criteria for PZH and PZ series outdoor unit.

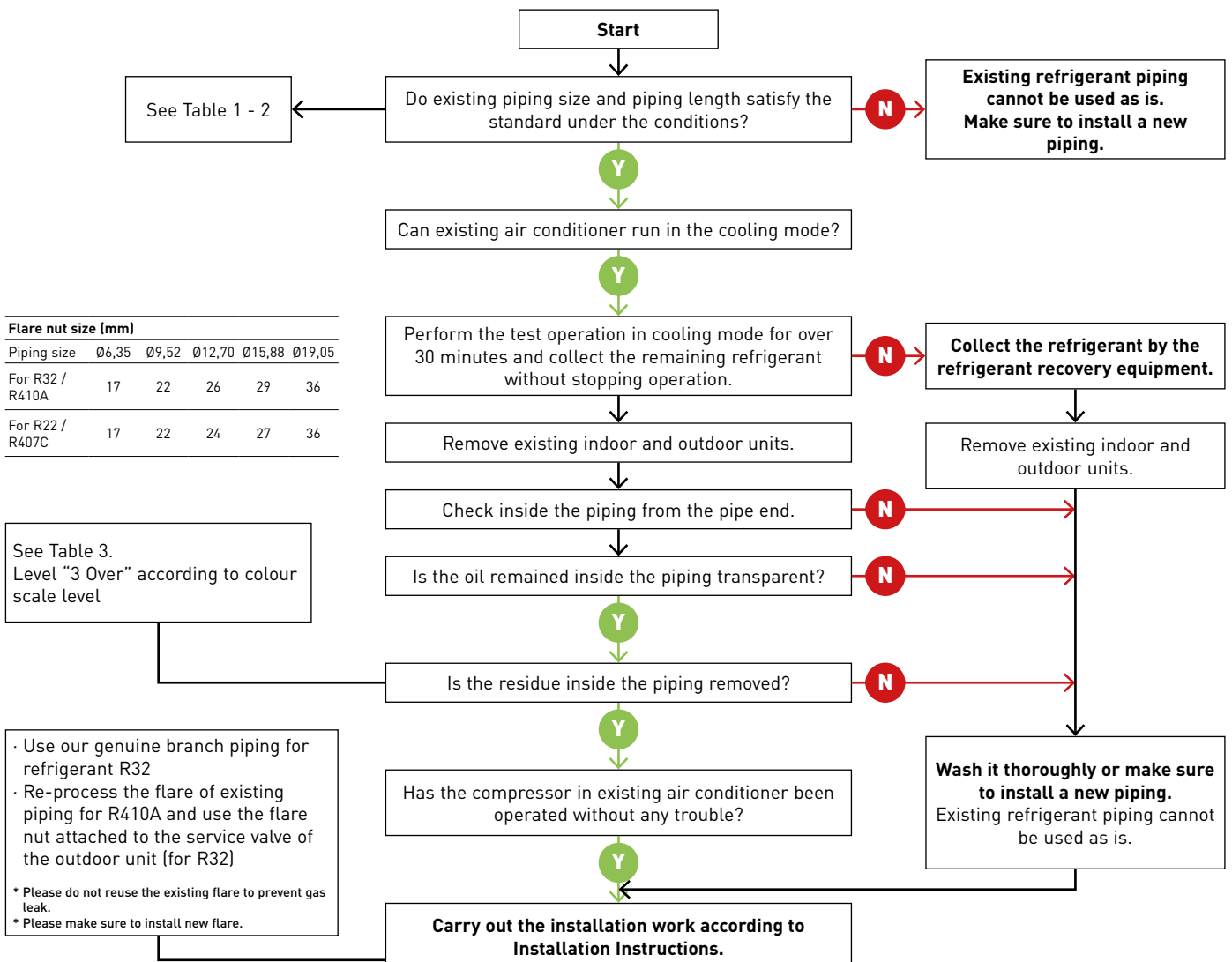

### Refrigerant piping size and allowable piping length.

Check if reuse of existing refrigerant piping is possible based on the following chart.

The standards other than this one (difference of elevation, etc.) are identical to the requirements of ordinary refrigerant piping.

**Table 1 - Reusable existing piping (mm)**

Material	0								1/2 H, H*	
External diameter	Ø6,35	Ø9,52	Ø12,70	Ø15,88	Ø19,05	Ø22,22	Ø25,40	Ø28,58		
Thickness	0,80	0,80	0,80	1,00	1,00	1,00	1,00	1,00	1,00	1,00

\* It is impossible to reuse the size of Ø19,05, Ø22,22, Ø25,4 and Ø28,58 for material O. Change to material 1/2H or material H.

**Table 2 - 1 Refrigerant piping size: 2,5 - 14,0 kW type (mm)**

Liquid pipe			Ø6,35				Ø9,52			Ø12,70	
Gas pipe			Ø9,52	Ø12,70	Ø15,88	Ø12,70	Ø15,88	Ø19,05	Ø15,88	Ø19,05	
PZH3	Type 36 ~ 60	Additional gas 15 g/m	✗	Standard 40 m (30 m)	✗	✗	✗	✗	✗	✗	✗
	Type 25		Tentative data								
PZ3	Type 36	Additional gas 10 g/m	✗	Standard 15 m (7,5 m)	✗	✗	✗	✗	✗	✗	✗
	Type 50	Additional gas 15 g/m	✗	Standard 20 m (7,5 m)	✗	✗	✗	✗	✗	✗	✗
	Type 60	Additional gas 15 g/m	✗	Standard 30 m (7,5 m)	✗	✗	✗	✗	✗	✗	✗
	Type 71	Additional gas 17 g/m	✗	✗	Standard 40 m (10 m)	✗	✗	✗	✗	✗	✗

Liquid pipe			Ø6,35				Ø9,52			Ø12,70	
Gas pipe			Ø9,52	Ø12,70	Ø15,88	Ø12,70	Ø15,88	Ø19,05	Ø15,88	Ø19,05	
PZH3	Type 71		✗	□ 10 m (10 m)	□ 10 m (10 m)	▽ 30 m (30 m)	Standard 50 m (30 m)	✗	□ 25 m (15 m)	□ 35 m (15 m)	✗
	Type 100 - 140		✗	✗	✗	✗	Standard 85 m (30 m)	⊙ 85 m (30 m)	□ 35 m (15 m)	□ 35 m (15 m)	
Additional gas			20 g/m				45 g/m			80 g/m	
PZ3	Type 100 - 140		✗	✗	✗	✗	Standard 50 m (30 m)	⊙ 50 m (30 m)	□ 25 m (15 m)	□ 25 m (15 m)	
Additional gas			20 g/m				45 g/m			80 g/m	
PZH2	Type 50		✗	Standard 40 m (30 m)	⊙ 40 m (30 m)	□ 20 m (15 m)	□ 20 m (15 m)	✗	✗	✗	✗
PZ2	Type 60 ~ 71		✗	▽ 10 m (10 m)	□ 10 m (10 m)	▽ 30 m (20 m)	Standard 50 m (20 m)	✗	□ 25 m (10 m)	□ 35 m (15 m)	✗
Additional refrigerant charging amount per 1 m			20 g/m				40 g/m			80 g/m	
PZH2	Type 60 ~ 71		✗	▽ 10 m (10 m)	□ 10 m (10 m)	▽ 30 m (30 m)	Standard 50 m (30 m)	✗	□ 25 m (15 m)	□ 35 m (15 m)	✗
	Type 100 - 140		✗	✗	✗	✗	Standard 75 m (30 m)	⊙ 75 m (30 m)	□ 35 m (15 m)	□ 35 m (15 m)	
PZ2	Type 100 - 140		✗	✗	✗	✗	Standard 50 m (30 m)	⊙ 50 m (30 m)	□ 25 m (15 m)	□ 25 m (15 m)	
Additional refrigerant charging amount per 1 m			20 g/m				50 g/m			80 g/m	

How to see table definition (example):

In case of type 71, standard size is liquid pipe Ø9,52 / gas pipe Ø15,88.

There is a limitation to liquid pipe Ø9,52 / gas pipe Ø12,70 and to liquid pipe Ø12,70 / gas pipe Ø15,88.

However, they are applicable for different diameter's pipes.

**Table 2 - 2 Refrigerant piping size: 20,0 - 25,0 kW type (mm)**

Liquid pipe			Ø9,52				Ø12,70			Ø15,88	
Gas pipe			Ø19,05	Ø22,22	Ø25,40	Ø19,05	Ø22,22	Ø25,40	Ø19,05	Ø22,22	Ø25,40
PZH4	Type 200 ~ 250		✗	✗	✗	▽ 100 m (30 m)	Standard 100 m (30 m)	⊙ 100 m (30 m)	▽ 65 m (20 m)	□ 65 m (20 m)	□ 65 m (20 m)
Additional refrigerant charging amount per 1 m			✗	✗	✗	80 g/m	80 g/m	80 g/m	120 g/m	120 g/m	120 g/m

⊙ Allowable      □ Limited piping length      50 m Maximum piping length  
 ▽ Cooling capacity down      ✗ Unallowable      (50 m) Charge less piping length in a single connection

**Table 3 - Deterioration Criteria for Refrigerant Oil**

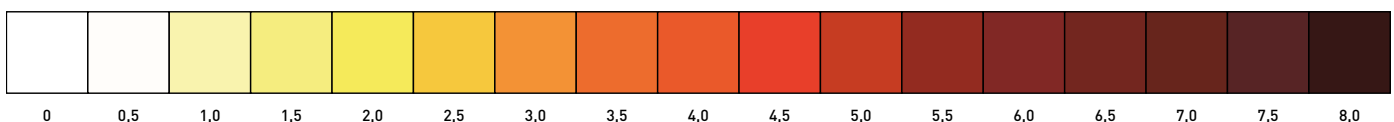

# Accessories and control

## Drain kits

Drain kit to suit outdoor units from 3,6 to 7,1 kW.

-----  
CZ-50DRS1

Drain kit to suit outdoor units from 10,0 to 25 kW.

-----  
CZ-140DRS1

## Branch Pipes, Header



Branch pipe.

-----  
CZ-P224BK2BM



Branch pipe (from 22,4 kW to 68 kW).

-----  
CZ-P680BK2BM



Header.

-----  
CZ-P3HPC2BM

## Special outdoor supports



Tray for condenser water compatible with outdoor elevation platform.

-----  
PAW-WTRAY



Outdoor elevation platform.

Dimension (HxWxD): 400x900x400 mm

-----  
PAW-GRDSTD40



Outdoor base ground support for noise and vibration absorption.

Dimension (HxWxD): 600x95x130 mm

Safe working load: 500 kg

-----  
PAW-GRDBSE20

## Panels



Panel for 4 way 60x60 cassette - PY3.

-----  
CZ-KPY4



Standard panel for 4 way 90x90 cassette, white (RAL9003).

-----  
CZ-KPU3



Econavi panel for 4 way 90x90 cassette, white (RAL9003).

-----  
CZ-KPU3A



**NEW** Standard panel for 4 way 90x90 cassette, graphite black (RAL9011).

-----  
CZ-KPU3B

## Sensors



Econavi energy saving sensor.

-----  
CZ-CENSC1



Remote temperature sensor.

-----  
CZ-CSRC3



Fresh air-intake kit.

-----  
CZ-FDU3+CZ-ATU2

IAQ filter for adaptive ducted unit



**BION air pollutant filter for S-3650PF3E.**

PAW-APF800F

**BION air pollutant filter for S-6071PF3E.**

PAW-APF1000F

**BION air pollutant filter for S-1014PF3E.**

PAW-APF1400F

Plenums

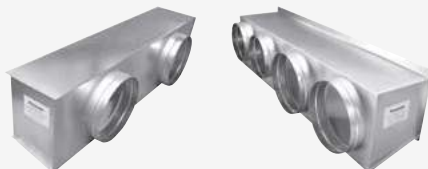

**Air outlet plenum for S-3650PF3E.**

CZ-56DAF2

**Air outlet plenum for S-1014PF3E.**

CZ-160DAF2

**Air outlet plenum for S-200PE4E.**

CZ-TREMIESPW705

**Air outlet plenum for S-6071PF3E.**

CZ-90DAF2

**Air outlet plenum for S-250PE4E.**

CZ-TREMIESPW706

VRF Smart Connectivity+



**Remote controller Panasonic Net Con, RH, No PIR, R1/R2.**

SER8150R0B1194

**Remote controller Panasonic Net Con, RH, PIR, R1/R2.**

SER8150R5B1194



**Wireless ZigBee® Pro module / Green Com card.**

VCM8000V5094P



**Door/window wireless sensor.**

SED-WDC-G-5045



**Wall/ceiling motion/temperature/humidity sensor.**

SED-MTH-G-5045



**CO<sub>2</sub> sensor.**

SED-CO2-G-5045



**Sensor with room temperature and humidity.**

SED-TRH-G-5045



**Water leakage sensor.**

SED-WLS-G-5045



**Cover frame. Silver.**

-----  
FAS-00



**Cover frame. White.**

-----  
FAS-01

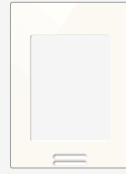

**Cover frame. Glossy translucent white.**

-----  
FAS-03



**Cover frame. Light tan wood.**

-----  
FAS-05



**Cover frame. Dark brown wood.**

-----  
FAS-06



**Cover frame. Dark black wood.**

-----  
FAS-07



**Cover frame. Brushed steel finish.**

-----  
FAS-10

**Controller and touch controllers for hotels with dry contacts**



**Modbus RS-485 touch room controller with I/O, white.**

-----  
PAW-RE2C4-MOD-WH

**Touch display control with 2 digital inputs, white.**

-----  
PAW-RE2D4-WH

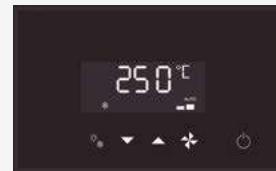

**Modbus RS-485 touch room controller with I/O, black.**

-----  
PAW-RE2C4-MOD-BK

**Touch display control with 2 digital inputs, black.**

-----  
PAW-RE2D4-BK

**Hotel sensors for dry contacts**



**Wall silent motion sensor 24 V.**

-----  
PAW-WMS-DC

**Wall silent motion sensor 240 V AC.**

-----  
PAW-WMS-AC



**Ceiling silent motion sensor 24 V.**

-----  
PAW-CMS-DC

**Ceiling silent motion sensor 240 V AC.**

-----  
PAW-CMS-AC



**Power supply 24 V.**

-----  
PAW-24DC



**Door or window contact.**

-----  
PAW-DWC

**Centralised controls**



**System controller for 64 indoor units with weekly timer.**

-----  
CZ-64ESMC3



**Central ON / OFF controller, up to 16 groups, 64 indoor units.**

-----  
CZ-ANC3



**Intelligent controller (touch screen/web server) to control up to 256 indoors with included load distribution ratio (LDR).**

-----  
CZ-256ESMC3



Panasonic AC Smart Cloud



+ ALL REFERENCES RELATED TO AC SMART CLOUD IS IN THE DEDICATED PAGE

**Panasonic AC Smart Cloud. Cloud internet control. Up to 128 groups. Controls 128 units.**

-----  
CZ-CFUSCC1

BMS interface with S-Link



**A unified interface supporting Modbus, BACnet, and KNX protocols for up to 16 indoor units.**

-----  
PAW-AC2-BMS-16

**A unified interface supporting Modbus, BACnet, and KNX protocols for up to 64 indoor units.**

-----  
PAW-AC2-BMS-64

**A unified interface supporting Modbus, BACnet, and KNX protocols for up to 128 indoor units.**

-----  
PAW-AC2-BMS-128

Accessories interfaces



**Commercial Wi-Fi Adaptor.**

-----  
CZ-CAPWFC2



**KNX interface (Intesis).**

-----  
PAW-RC2-KNX-1i



**Modbus RTU interface (Intesis).**

-----  
PAW-RC2-MBS-1



**Modbus RTU interface to control 4 indoor/ groups (Intesis).**

-----  
PAW-RC2-MBS-4



**BACnet IP and MSTP (Intesis).**

-----  
PAW-RC2-BAC-1



**KNX interface (Airzone).**

-----  
PAW-AZRC-KNX-1



**Modbus RTU interface (Airzone).**

-----  
PAW-AZRC-MBS-1



**BACnet IP and MSTP interface (Airzone).**

-----  
PAW-AZRC-BAC-1















**RAC interface adapter for integration into S-Link, plus external input and alarm/ status output (for YKEA units).**

-----  
CZ-CAPRA1



Centralised controls. Connection with general equipment

 <p><b>Adaptor for ON / OFF control of external devices.</b></p> <p>----- CZ-CAPC3</p>	 <p><b>Mini series parallel device controlling indoor units, maximum 1 group and 8 indoor unit.</b></p> <p>----- CZ-CAPBC2</p>	 <p><b>Communication Adaptor. Up to 128 groups. Controls 128 units.</b></p> <p>----- CZ-CFUNC2</p>
---	---	---





Individual controls

 <p><b>CONEX wired remote controller (non-wireless), white.</b></p> <p>----- CZ-RTC6W</p>	 <p><b>CONEX wired remote controller with Bluetooth®, white.</b></p> <p>----- CZ-RTC6WBL</p>	 <p><b>CONEX wired remote controller with Wi-Fi and Bluetooth®, white.</b></p> <p>----- CZ-RTC6WBLW2</p>	 <p><b>CONEX wired remote controller (non-wireless), black.</b></p> <p>----- CZ-RTC6</p>
 <p><b>CONEX wired remote controller with Bluetooth®, black.</b></p> <p>----- CZ-RTC6BL</p>	 <p><b>CONEX wired remote controller with Wi-Fi and Bluetooth®, black.</b></p> <p>----- CZ-RTC6BLW2</p>	 <p><b>Design Wired remote controller with Econavi function.</b></p> <p>----- CZ-RTC5B</p>	 <p><b>Infrared remote controller for wall-mounted.</b></p> <p>----- CZ-RWS3</p>
 <p><b>Infrared remote controller and receiver for 4 way 60x60 cassette - PY3 with panel.</b></p> <p>----- CZ-RWS3 + CZ-RWRY3</p>	 <p><b>Infrared remote controller and receiver for 4 way 90x90 cassette.</b></p> <p>----- CZ-RWS3 + CZ-RWRU3</p>	 <p><b>Infrared remote controller and receiver for ceiling.</b></p> <p>----- CZ-RWS3 + CZ-RWRT3</p>	 <p><b>Infrared remote controller and receiver for all indoor units.</b></p> <p>----- CZ-RWS3 + CZ-RWRC3</p>

Accessories PCB

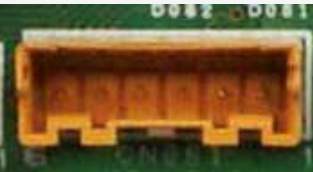
 <p><b>T10 interface PCB with digital and relay connections.</b></p> <p>-----</p> <p>PAW-T10</p>	 <p><b>PCB for server room application, control up to 4 indoor unit groups, redundancy, backup, etc.</b></p> <p>-----</p> <p>PAW-PACR4</p>	 <p><b>Connector to PACi NX indoor unit's PCB to provide OPT functions.</b></p> <p>-----</p> <p>PAW-OPT-NX</p>	 <p><b>Redundancy of 2 units YKEA-1. SG Ready.</b></p> <p>-----</p> <p>PAW-SERVER-PKEA-1</p>
---	---	--	---

Accessories cables

 <p><b>Cable for all the T10 functions.</b></p> <p>-----</p> <p>CZ-T10</p>	 <p><b>Cable to operate external EC fan.</b></p> <p>-----</p> <p>PAW-FDC</p>	 <p><b>Cable for all option monitoring signals.</b></p> <p>-----</p> <p>PAW-OCT</p>	 <p><b>Cable with force thermo OFF/leakage detection.</b></p> <p>-----</p> <p>PAW-EXCT</p>
---	---	---	---

Accessories for Jet Air Stream

 <p><b>Touch panel controller with Modbus integration and group control up to 8 units.</b></p> <p>-----</p> <p>PCZ-AHRX0012</p>	 <p><b>Recessed mounting box for controller.</b></p> <p>-----</p> <p>PCZ-AHRP0681</p>	 <p><b>Ducted air intake plenum (1 x DN 355 mm) for VTVF140N and VTVF140P.</b></p> <p>-----</p> <p>PCZ-AHRX0051</p>
 <p><b>Ducted air intake plenum (2 x DN 355 mm) for VTVF250N and VTVF250P.</b></p> <p>-----</p> <p>PCZ-AHRX0052</p>	 <p><b>Ground air intake module (VTVF250 requires two of them).</b></p> <p>-----</p> <p>PCZ-AHRX0061</p>	 <p><b>Air supply grille for ducts.</b></p> <p>-----</p> <p>PCZ-AHRX0071</p>

## Eurovent certified technical data

Panasonic's PACi NX and VRF systems are now certified by Eurovent\*. The Eurovent certification verifies the performance ratings of heating and cooling systems following European standards. Data provides products efficiency with full transparency, for the benefit of customers and professionals.

### Eurovent AC1 certified technical data: Wall-mounted Professional YKEA · R32

Kit			KIT-Z25-YKEA-1	KIT-Z35-YKEA-1	KIT-Z42-YKEA-1	KIT-Z50-YKEA-1	KIT-Z71-YKEA-1
Outdoor unit			CU-Z25YKEA-1	CU-Z35YKEA-1	CU-Z42YKEA-1	CU-Z50YKEA-1	CU-Z71YKEA-1
Indoor unit			CS-Z25YKEA-1	CS-Z35YKEA-1	CS-Z42YKEA-1	CS-Z50YKEA-1	CS-Z71YKEA-1
Seasonal efficiency in cooling (SEASC)	Pdesignc	kW	2,50	3,50	4,20	4,70	7,10
	SEER		9,50	9,60	8,60	8,60	6,50
	Qce	kWh/annum	92,00	128,00	171,00	191	382,00
Standard cooling PL Condition A (STD cooling)	Nominal cooling capacity (Pc)	kW	2,50	3,50	4,20	4,7	7,10
	Input power (Pec)	kW	0,51	0,85	1,10	1,12	2,20
	EER		4,90	4,12	3,82	4,2	3,23
Heating average climate (SEASHAvg)	Pdesignh	kW	2,70	3,20	3,60	4,20	5,50
	SCOP		4,60	4,60	4,50	4,60	4,10
	Qhe	kWh/annum	822,00	974,00	1120,00	1278,00	1878,00
Standard heating (STD heating)	Nominal heating capacity (Ph)	kW	3,40	4,00	5,30	5,80	8,20
	Input power (Peh)	kW	0,70	0,90	1,35	1,42	2,21
	COP		4,86	4,44	3,93	4,08	3,71
Acoustic (sound)	Lw0 env	dB(A)	61	63	64	63	66

## Commercial air to air - PACi NX

### Eurovent AC1 certified technical data: PACi NX Series Elite wall-mounted - PK4 · R32

Outdoor unit			U-36PZH3E5	U-50PZH3E5	U-60PZH3E5	U-71PZH4E5	U-71PZH4E8	U-100PZH4E5	U-100PZH4E8
Indoor unit			S-2545PK4E	S-5010PK4E	S-5010PK4E	S-5010PK4E	S-5010PK4E	S-5010PK4E	S-5010PK4E
Seasonal efficiency in cooling (SEASC)	Pdesignc	kW	3,50	5,00	6,10	7,10	7,10	9,50	9,50
	SEER		7,70	8,00	7,10	6,60	6,60	6,60	6,60
	Qce	kWh/annum	160,00	219,00	301,00	377,00	377,00	504,00	504,00
Standard cooling PL Condition A (STD cooling)	Nominal cooling capacity (Pc)	kW	3,50	5,00	6,10	7,10	7,10	9,50	9,50
	Input power (Pec)	kW	0,79	1,22	1,63	1,89	1,89	2,79	2,79
	EER		4,43	4,10	3,74	3,76	3,76	3,41	3,41
Heating average climate (SEASHAvg)	Pdesignh	kW	3,10	4,50	4,60	5,20	5,20	8,00	8,00
	SCOP		4,70	4,60	4,70	4,60	4,60	4,10	4,10
	Qhe	kWh/annum	924,00	1369,00	1370,00	1583,00	1583,00	2731,00	2731,00
Standard heating (STD heating)	Nominal heating capacity (Ph)	kW	4,00	5,60	7,00	7,80	7,80	9,50	9,50
	Input power (Peh)	kW	0,94	1,39	1,70	1,95	1,95	2,44	2,44
	COP		4,26	4,03	4,12	4,00	4,00	3,89	3,89
Acoustic (sound)	Lw0 env	dB(A)	62	64	65	65	65	69	69

### Eurovent AC1 certified technical data: PACi NX Series Elite 4 way 60x60 cassette - PY3 · R32

Outdoor unit			U-36PZH3E5	U-50PZH3E5	U-60PZH3E5
Indoor unit			S-36PY3E	S-50PY3E	S-60PY3E
Seasonal efficiency in cooling (SEASC)	Pdesignc	kW	3,60	4,7	6,00
	SEER		7,30	7,00	6,70
	Qce	kWh/annum	171,00	235	314,00
Standard cooling PL Condition A (STD cooling)	Nominal cooling capacity (Pc)	kW	3,60	4,7	6,00
	Input power (Pec)	kW	0,80	1,25	1,75
	EER		4,50	3,76	3,43
Heating average climate (SEASHAvg)	Pdesignh	kW	3,60	4,50	4,60
	SCOP		4,70	4,60	4,30
	Qhe	kWh/annum	1073,00	1370,00	1498,00
Standard heating (STD heating)	Nominal heating capacity (Ph)	kW	4,00	5,60	7,00
	Input power (Peh)	kW	0,97	1,66	2,06
	COP		4,12	3,37	3,40
Acoustic (sound)	Lw0 env	dB(A)	62	64	65



### Eurovent AC1 certified technical data: PACi NX Series Elite 4 way 90x90 cassette - PU3 · R32

Outdoor unit			U-36PZH3E5	U-50PZH3E5	U-60PZH3E5	U-71PZH4E5	U-71PZH4E8	U-100PZH4E8	U-100PZH4E5
Indoor unit			S-3650PU3E	S-3650PU3E	S-6071PU3E	S-6071PU3E	S-6071PU3E	S-1014PU3E	S-1014PU3E
Seasonal efficiency in cooling (SEASC)	Pdesignc	kW	3,60	5,00	6,00	7,10	7,10	9,50	9,50
	SEER		8,90	8,60	8,00	7,70	7,70	7,80	7,80
	Qce	kWh/annum	142,00	203,00	263,00	323,00	323,00	426,00	426,00
Standard cooling PL Condition A (STD cooling)	Nominal cooling capacity (Pc)	kW	3,60	5,00	6,00	7,10	7,10	9,50	9,50
	Input power (Pec)	kW	0,66	1,16	1,48	1,75	1,75	2,15	2,15
	EER		5,45	4,31	4,05	4,06	4,06	4,42	4,42
Heating average climate (SEASHAvg)	Pdesignh	kW	3,60	4,50	4,70	5,20	5,20	8,00	8,00
	SCOP		5,10	4,90	4,80	4,80	4,80	4,90	4,90
	Qhe	kWh/annum	988,00	1286,00	1371,00	1517,00	1517,00	2286,00	2286,00
Standard heating (STD heating)	Nominal heating capacity (Ph)	kW	4,00	5,60	7,00	8,00	8,00	11,20	11,20
	Input power (Peh)	kW	0,74	1,32	1,74	1,86	1,86	2,24	2,24
	COP		5,41	4,24	4,02	4,30	4,30	5,00	5,00
Acoustic (sound)	LwO env	dB(A)	62	64	65	65	65	69	69

### Eurovent AC1 certified technical data: PACi NX Series Elite ceiling - PT3 · R32

Outdoor unit			U-36PZH3E5	U-50PZH3E5	U-60PZH3E5	U-71PZH4E5	U-71PZH4E8	U-100PZH4E8	U-100PZH4E5
Indoor unit			S-3650PT3E	S-3650PT3E	S-6071PT3E	S-6071PT3E	S-6071PT3E	S-1014PT3E	S-1014PT3E
Seasonal efficiency in cooling (SEASC)	Pdesignc	kW	3,50	5,00	6,00	6,80	6,80	9,50	9,50
	SEER		7,70	7,40	7,50	7,30	7,20	7,30	7,20
	Qce	kWh/annum	160,00	237,00	280,00	326,00	331,00	456,00	462,00
Standard cooling PL Condition A (STD cooling)	Nominal cooling capacity (Pc)	kW	3,50	5,00	6,00	6,80	6,80	9,50	9,50
	Input power (Pec)	kW	0,72	1,24	1,57	1,74	1,74	2,34	2,34
	EER		4,86	4,03	3,82	3,91	3,91	4,06	4,06
Heating average climate (SEASHAvg)	Pdesignh	kW	3,10	4,00	4,60	4,70	4,70	7,80	7,80
	SCOP		4,90	4,80	4,80	4,70	4,70	4,50	4,50
	Qhe	kWh/annum	886,00	1167,00	1342,00	1400,00	1400,00	2426,00	2427,00
Standard heating (STD heating)	Nominal heating capacity (Ph)	kW	4,00	5,60	7,00	8,00	8,00	11,20	11,20
	Input power (Peh)	kW	0,80	1,39	1,69	2,02	2,02	2,80	2,80
	COP		5,00	4,03	4,14	3,96	3,96	4,00	4,00
Acoustic (sound)	LwO env	dB(A)	62	64	65	65	65	69	69

### Eurovent AC1 certified technical data: PACi NX Series Elite adaptive ducted unit - PF3 · R32

Outdoor unit			U-36PZH3E5	U-50PZH3E5	U-60PZH3E5	U-71PZH4E5	U-71PZH4E8	U-100PZH4E8	U-100PZH4E5
Indoor unit			S-3650PF3E	S-3650PF3E	S-6071PF3E	S-6071PF3E	S-6071PF3E	S-1014PF3E	S-1014PF3E
Seasonal efficiency in cooling (SEASC)	Pdesignc	kW	3,60	5,00	5,70	6,80	6,80	9,50	9,50
	SEER		6,80	6,10	7,10	7,10	7,10	7,40	7,40
	Qce	kWh/annum	185,00	287,00	281,00	332,00	332,00	447,00	447,00
Standard cooling PL Condition A (STD cooling)	Nominal cooling capacity (Pc)	kW	3,60	5,00	5,70	6,80	6,80	9,50	9,50
	Input power (Pec)	kW	0,85	1,46	1,55	1,82	1,82	2,32	2,32
	EER		4,24	3,42	3,68	3,74	3,74	4,09	4,09
Heating average climate (SEASHAvg)	Pdesignh	kW	3,60	4,00	4,70	4,70	4,70	7,80	7,80
	SCOP		4,50	4,20	4,40	4,70	4,70	4,30	4,30
	Qhe	kWh/annum	1120,00	1333,00	1495,00	1393,00	1394,00	2540,00	2540,00
Standard heating (STD heating)	Nominal heating capacity (Ph)	kW	4,00	5,60	7,00	7,50	7,50	10,80	10,80
	Input power (Peh)	kW	0,96	1,55	1,87	1,86	1,86	2,78	2,78
	COP		4,17	3,61	3,74	4,03	4,03	3,88	3,88
Acoustic (sound)	LwO env	dB(A)	62	64	65	65	65	69	69

## Eurovent certified technical data

## Commercial air to air - PACi NX

## Eurovent AC1 certified technical data: PACi NX Series Standard wall-mounted - PK4 · R32

Outdoor unit			U-25PZ3E5	U-36PZ3E5	U-50PZ3E5	U-60PZ3E5A	U-71PZ3E5A	U-100PZ3E5	U-100PZ3E8
Indoor unit			S-2545PK4E	S-2545PK4E	S-5010PK4E	S-5010PK4E	S-5010PK4E	S-5010PK4E	S-5010PK4E
Seasonal efficiency in cooling (SEASC)	Pdesignc	kW	2,50	3,50	5,00	6,10	6,90	9,00	9,00
	SEER		6,60	6,80	7,20	7,00	6,00	6,20	6,20
	Qce	kWh/annum	133,00	181,00	243,00	305,00	402,00	508,00	508,00
Standard cooling PL Condition A (STD cooling)	Nominal cooling capacity (Pc)	kW	2,50	3,50	5,00	6,10	6,90	9,00	9,00
	Input power (Pec)	kW	0,57	0,90	1,47	1,71	2,10	2,79	2,79
	EER		4,39	3,89	3,40	3,57	3,29	3,23	3,23
Heating average climate (SEASHAvg)	Pdesignh	kW	2,50	2,60	4,00	4,60	5,20	8,80	8,80
	SCOP		4,20	4,40	4,40	4,60	4,40	4,00	4,00
	Qhe	kWh/annum	833,00	827,00	1271,00	1400,00	1654,00	3080,00	3080,00
Standard heating (STD heating)	Nominal heating capacity (Ph)	kW	2,80	3,60	5,00	6,10	7,10	9,00	9,00
	Input power (Peh)	kW	0,62	0,88	1,19	1,43	1,73	2,36	2,36
	COP		4,52	4,09	4,20	4,27	4,10	3,81	3,81
Acoustic (sound)	Lw0 env	dB(A)	64	64	64	64	66	70	70

## Eurovent AC1 certified technical data: PACi NX Series Standard 4 way 60x60 cassette - PY3 · R32

Outdoor unit			U-25PZ3E5	U-36PZ3E5	U-50PZ3E5	U-60PZ3E5A
Indoor unit			S-25PY3E	S-36PY3E	S-50PY3E	S-60PY3E
Seasonal efficiency in cooling (SEASC)	Pdesignc	kW	2,50	3,60	4,7	6,00
	SEER		6,50	6,70	7,30	6,80
	Qce	kWh/annum	134,00	188,00	226	305,00
Standard cooling PL Condition A (STD cooling)	Nominal cooling capacity (Pc)	kW	2,50	3,60	4,7	6,00
	Input power (Pec)	kW	0,56	0,91	1,34	1,77
	EER		4,46	3,96	3,51	3,39
Heating average climate (SEASHAvg)	Pdesignh	kW	2,80	2,80	4,00	4,60
	SCOP		4,60	4,30	4,40	4,20
	Qhe	kWh/annum	850,00	912,00	1264,00	1500,00
Standard heating (STD heating)	Nominal heating capacity (Ph)	kW	3,20	3,60	5,00	6,00
	Input power (Peh)	kW	0,72	0,84	1,27	1,66
	COP		4,44	4,29	3,94	3,61
Acoustic (sound)	Lw0 env	dB(A)	64	64	64	64

## Eurovent AC1 certified technical data: PACi NX Series Standard 4 way 90x90 cassette - PU3 · R32

Outdoor unit			U-36PZ3E5	U-50PZ3E5	U-60PZ3E5A	U-71PZ3E5A	U-100PZ3E5	U-100PZ3E8
Indoor unit			S-3650PU3E	S-3650PU3E	S-6071PU3E	S-6071PU3E	S-1014PU3E	S-1014PU3E
Seasonal efficiency in cooling (SEASC)	Pdesignc	kW	3,60	5,00	6,00	7,10	10,00	10,00
	SEER		8,10	8,00	7,80	6,80	6,80	6,70
	Qce	kWh/annum	156,00	219,00	269,00	365,00	515,00	521,00
Standard cooling PL Condition A (STD cooling)	Nominal cooling capacity (Pc)	kW	3,60	5,00	6,00	7,10	10,00	10,00
	Input power (Pec)	kW	0,83	1,28	1,61	2,17	2,62	2,62
	EER		4,34	3,91	3,73	3,27	3,82	3,82
Heating average climate (SEASHAvg)	Pdesignh	kW	2,80	4,00	4,60	5,20	10,00	10,00
	SCOP		4,80	4,70	4,90	4,60	4,40	4,40
	Qhe	kWh/annum	817,00	1191,00	1314,00	1583,00	3182,00	3182,00
Standard heating (STD heating)	Nominal heating capacity (Ph)	kW	3,60	5,00	6,00	7,10	10,00	10,00
	Input power (Peh)	kW	0,71	1,08	1,34	1,68	2,03	2,03
	COP		5,07	4,63	4,48	4,23	4,93	4,93
Acoustic (sound)	Lw0 env	dB(A)	64	64	64	66	70	70

**Eurovent AC1 certified technical data: PACi NX Series Standard ceiling - PT3 · R32**

Outdoor unit			U-36PZ3E5	U-50PZ3E5	U-60PZ3E5A	U-71PZ3E5A	U-100PZ3E5	U-100PZ3E8
Indoor unit			S-3650PT3E	S-3650PT3E	S-6071PT3E	S-6071PT3E	S-1014PT3E	S-1014PT3E
Seasonal efficiency in cooling (SEASC)	Pdesignc	kW	3,50	5,00	6,00	6,80	10,00	10,00
	SEER		7,20	6,70	7,30	5,90	6,60	6,50
	Qce	kWh/annum	171,00	262,00	288,00	404,00	531,00	537,00
Standard cooling PL Condition A (STD cooling)	Nominal cooling capacity (Pc)	kW	3,50	5,00	6,00	6,80	10,00	10,00
	Input power (Pec)	kW	0,85	1,65	1,67	2,10	2,75	2,75
	EER		4,14	3,03	3,59	3,24	3,64	3,64
Heating average climate (SEASHAvg)	Pdesignh	kW	2,80	4,00	4,60	4,70	10,00	10,00
	SCOP		4,40	4,10	4,60	4,30	4,20	4,20
	Qhe	kWh/annum	891,00	1365,00	1399,00	1529,00	3331,00	3331,00
Standard heating (STD heating)	Nominal heating capacity (Ph)	kW	3,50	5,00	6,00	6,80	10,00	10,00
	Input power (Peh)	kW	0,76	1,34	1,46	1,62	2,36	2,36
	COP		4,61	3,73	4,11	4,20	4,24	4,24
Acoustic (sound)	LwO env	dB(A)	64	64	64	66	70	70

**Eurovent AC1 certified technical data: PACi NX Series Standard adaptive ducted unit - PF3 · R32**

Outdoor unit			U-36PZ3E5	U-50PZ3E5	U-60PZ3E5A	U-71PZ3E5A	U-100PZ3E5	U-100PZ3E8
Indoor unit			S-3650PF3E	S-3650PF3E	S-6071PF3E	S-6071PF3E	S-1014PF3E	S-1014PF3E
Seasonal efficiency in cooling (SEASC)	Pdesignc	kW	3,40	5,00	5,70	6,80	9,50	9,50
	SEER		6,00	6,50	6,40	6,00	6,60	6,50
	Qce	kWh/annum	198,00	267,00	310,00	391,00	502,00	508,00
Standard cooling PL Condition A (STD cooling)	Nominal cooling capacity (Pc)	kW	3,40	5,00	5,70	6,80	9,50	9,50
	Input power (Pec)	kW	0,90	1,80	1,61	2,14	2,66	2,66
	EER		3,78	2,78	3,54	3,18	3,57	3,57
Heating average climate (SEASHAvg)	Pdesignh	kW	2,40	3,80	4,40	4,70	7,80	7,80
	SCOP		4,00	4,00	4,40	4,10	3,90	3,90
	Qhe	kWh/annum	839,00	1303,00	1376,00	1591,00	2795,00	2795,00
Standard heating (STD heating)	Nominal heating capacity (Ph)	kW	3,40	5,00	5,70	6,80	9,50	9,50
	Input power (Peh)	kW	0,82	1,38	1,41	1,70	2,32	2,32
	COP		4,15	3,62	4,04	4,00	4,09	4,09
Acoustic (sound)	LwO env	dB(A)	64	64	64	66	70	70



## Commercial VRF Systems

Panasonic VRF Systems are specifically designed for energy saving, easy installation and high efficiency performance. A wide range of outdoor and indoor unit models offer unique features which are designed for the most demanding offices and large buildings.

**ECO*i* EX** / **ECO*i*** / **ECO G**







VRF highlighted features	→ 282	Panasonic DX PRO Designer	→ 354
The complete VRF solution for efficiency, quality, and comfort	→ 284	R22 Renewal	→ 355
Panasonic VRF: TOP in comfort	→ 286		
Bringing nature's balance indoors	→ 288	<b>ECOi and ECO G indoor units range</b>	→ 356
BION air pollutant filter	→ 290	U2 type 4 way 90x90 cassette · R32 / R410A	→ 359
Solutions for Restaurants	→ 292	Y3 type 4 way 60x60 cassette · R32 / R410A	→ 360
Your entire hotel with superior comfort	→ 294	L1 type 2 way cassette · R410A	→ 361
Innovative solutions for retail	→ 296	D1 type 1 way cassette · R410A	→ 362
Best efficiency ECOi Series from Panasonic	→ 300	F3 type variable static pressure adaptive duct · R32 / R410A	→ 363
Mini ECOi LZ2 Series R32	→ 302	M2 type slim variable static pressure hide-away concealed duct · R32 / R410A	→ 364
Mini ECOi LE Series R410A	→ 306	E2 type high static pressure hide-away · R410A	→ 365
ECOi EX Series	→ 310	T2 type ceiling · R410A	→ 368
New generation of 2-Pipe ECOi EX MZ1 Series R32	→ 314	K3 type wall-mounted · R32 / R410A	→ 367
2-Pipe ECOi EX ME2 Series R410A	→ 320	G1 type floor console · R410A	→ 369
3-Pipe ECOi EX MF3 Series R410A	→ 328	P1 type floor-standing · R410A	→ 370
Slim 3-Pipe control box kit / Multiple connection type	→ 329	R1 type concealed floor-standing · R410A	→ 370
ECO G, the gas driven VRF	→ 334	Hydrokit for ECOi, water at 45 °C · R410A	→ 371
Panasonic GHP/EHP Hybrid System	→ 344	HT Booster for ECOi EX Series, water at 70 °C · R410A	→ 372
Water heat exchanger for hydronic applications	→ 348		
Leak detection and automatic refrigerant Pump Down for R410A refrigerant	→ 352	<b>Ventilation</b>	
		AHU connection kit MAH4M for ECOi 2-Pipe	→ 374
<b>VRF outdoor units range</b>	→ 298	AHU connection kit MAH3M for ECOi and ECO G	→ 375
Mini ECOi LZ2 Series 4 to 6 HP · R32	→ 286	Advanced energy recovery ventilation - ZY Series	→ 376
Mini ECOi LZ2 Series 8 and 10 HP · R32	→ 287	Energy recovery ventilation with DX coil - HRPT Series · R32 / R410A	→ 377
Mini ECOi LE2 Series high efficiency 4 to 6 HP · R410A	→ 290	Air curtain with DX coil, connected to VRF systems	→ 378
Mini ECOi LE1 Series high efficiency 8 and 10 HP · R410A	→ 291	Ceiling mounted air-e nanoe X Generator	→ 379
2-Pipe ECOi EX MZ1 Series · R32	→ 297		
2-Pipe ECOi EX ME2 Series · R410A	→ 303	Accessories and control	→ 380
3-Pipe ECOi EX MF3 Series · R410A	→ 312		
2-Pipe ECO G GE3 Series · R410A	→ 320	Dimensions and tube sizes of branches and headers	→ 388
3-Pipe ECO G GF3 Series R410A	→ 322		
3-Pipe ECO G GF3 Series · R410A	→ 323	Eurovent certified technical data	→ 392
2-Pipe Hybrid GHP/EHP	→ 347		
ECOi 2-Pipe with water heat exchanger	→ 350		
ECO G with water heat exchanger	→ 351		

# VRF highlighted features

Panasonic provides an extensive range of solutions for medium and large sized buildings, combining the best options to satisfy all needs and site restrictions.



ECOi. Electrical VRF				ECO G. Gas Powered VRF		
R32	R410A	R32	R410A	R410A	R410A	R410A
Mini ECOi LZ2	Mini ECOi LE2/LE1	ECOi EX MZ1	ECOi EX ME2	ECOi EX MF3	ECO G GE3	ECO G GF3
<b>Capacity range</b>						
4 - 10 HP	4 - 10 HP	8 - 48 HP	8 - 80 HP	8 - 48 HP	16 - 60 HP	16 - 25 HP
<b>Extreme temperatures operation</b>						
-20 °C (heating) / 52 °C (cooling)	-20 °C (heating) / 46 °C (cooling)	-25 °C (heating) / 52 °C (cooling)	-25 °C (heating) / 52 °C (cooling)	-20 °C (heating) / 52 °C (cooling)	-21 °C (heating) / 43 °C (cooling)	-21 °C (heating) / 43 °C (cooling)
<b>Maximum number of connectable indoor units</b>						
16 <sup>1)</sup>	15	64	64	52	64	24
<b>Indoor to outdoor connection ratio</b>						
50 ~ 150%	50 ~ 130%	50 ~ 200%	50 ~ 200%	50 ~ 150%	50 ~ 200% <sup>2)</sup>	50 ~ 200%
<b>Indoor units</b>						
All (check restrictions)						
<b>Controls</b>						
All						
<b>Other ranges integration</b>						
PACi range full control integration + Domestic range integration by accessory						

1) For 6 HP model. 2) 50 ~ 200% only when one outdoor unit is installed. In other cases 50 ~ 130%.

Panasonic ECOi is Eurovent certified. Panasonic's VRF systems - ECOi range is now certified by Eurovent\*.

The Eurovent certification verifies the performance ratings of heating and cooling systems following European standards. Those data provides products efficiency with full transparency for the benefit of customers and professionals.



\* Reference website: <https://www.eurovent-certification.com/en>.

## Energy saving

R32

REFRIGERANT

### Refrigerant R32.

Our heat pumps containing R32 refrigerant show a drastic reduction in the value of Global Warming Potential (GWP).



INVERTER+

### Inverter Plus system.

Inverter Plus system classification highlights Panasonic's highest performing systems.



R2 ROTARY COMPRESSOR

### Panasonic R2 rotary compressor.

Designed to withstand extreme conditions, it delivers high performance and efficiency.



ALL INVERTER COMPRESSORS

### All Inverter compressors.

Multiple large-capacity all Inverter compressors (more than 14 HP). Two independently controlled Inverter compressors achieve high efficiency. Redesigned components in the body provide performance improvement especially in the rated cooling condition and EER performance.



HIGH COP

### High COP.

High efficiency models performs higher COP than standard units and standard combinations.

GAS POWERED

ECO G

### Gas powered.

ECO G technology offers the best in energy efficiency. ECO G gas VRF is specially designed for buildings where the electricity is restricted or CO<sub>2</sub> emissions must be reduced.



ECONAVI

### Econavi.

Intelligent human activity sensor and sunlight sensor technologies that can detect and reduces the waste of energy by optimising air conditioner operation according to room conditions. With just one touch of a button, you can save energy.

ErP

✓

### ERP 2018.

Compliant following COMMISSION REGULATION (EU) No2016/2281.

## High performance and indoor air quality



BLUEFIN

### Bluefin.

Panasonic has extended the life of its condensers with an original anti-rust coating.

-10 °C

COOLING MODE

### Down to -10 °C in cooling mode.

The air conditioner works in cooling mode when the outdoor temperature of -10 °C.

-25 °C

HEATING MODE

### Down to -25 °C in heating mode.

The air conditioner works in heat pump mode when the outdoor temperature is as low as -25 °C.

52 °C

COOLING MODE

### Cooling with outdoor temperature up to 52 °C.

The ECOi EX system works in cooling mode with performance data at outdoor temperature up to 52 °C.



AUTOMATIC RESTART

### Automatic restart.

Automatic restart function for power failure. Even when power failure occurs, preset programmed operation can be reactivated once power is resumed.



R22 RENEWAL

### R22 renewal.

The Panasonic renewal system allows good quality existing R22 pipe work to be re-used whilst installing high efficiency R410A systems.



nanoe X

### nanoe™ X.

Technology with the benefits of hydroxyl radicals has the capacity to inhibit pollutants, viruses, and bacteria to clean and deodorise.



SELF-DIAGNOSING

### Self-diagnosing function.

By using electronic control valves past warnings are stored. This makes it easier to diagnose malfunctions, reducing service labour and therefore costs.



AUTOMATIC FAN

### Automatic fan operation.

Convenient microprocessor control automatically adjusts fan speed to High, Medium or Low, corresponding to room sensor and maintains comfortable air flow throughout the room.



HUMIDITY CONTROL DRY

### Mild Dry.

By intermittent control of compressor and indoor unit's fan, "Mild Dry" gives you comfort. It realizes efficient dehumidification according to room temperature.



AUTO-FLAP CONTROL

### Comfortable auto-flap control.

When the unit is first turned on, flap position is automatically adjusted in accordance with the cooling or heating operation.



AIR SWEEP

### Air Sweep.

The air sweep function moves the flap up and down in the air outlet, directing air in a "sweeping" motion around the room and providing comfort in every corner.



BUILT-IN DRAIN PUMP

### Built-in drain pump.

Maximum head 50 cm (or 75 cm for U type) from the bottom of the unit.



FILTER INCLUDED

### Filter included.

Hide-away with filter included.



5 YEARS COMPRESSOR WARRANTY

### 5 Years compressor warranty.

We guarantee the outdoor unit compressors in the entire range for five years.

## High connectivity



INTEGRATION TO S-LINK

### Domestic integration to S-Link - CZ-CAPRA1.

Can connect RAC range to S-Link. Full control is now possible.



INTERNET CONTROL

### Internet control.

A next generation system providing user-friendly control of air conditioning or heat pump units from everywhere, using a simple Android™ or iOS smartphone or tablet via Wi-Fi.



BMS CONNECTIVITY

### BMS connectivity.

The communication port can be integrated into the indoor unit and provides easy connection to, and control of, your Panasonic air conditioner to your home or Building Management System.



PANASONIC AC SMART CLOUD

### Panasonic AC Smart Cloud.

The AC Smart Cloud from Panasonic allows you to have complete control of all your installations. In a simple click, receive status updates from all your units in real-time, preventing breakdowns and optimising costs.

# The complete VRF solution for efficiency, quality, and comfort



To meet the latest market demands for decarbonised buildings, the ECOi range with R32 refrigerant has been expanded to 48 HP offering a comprehensive portfolio. In line with F-gas regulations, R32 ECOi is a future-ready VRF solution.

Panasonic VRF, extended decarbonised solution. R32 ECOi range from 4–12 HP, expandable up to 48 HP. A comprehensive line-up featuring nanoe™ X indoor units, hydronic and ventilation solutions, and seamless BMS connectivity.



R32 REFRIGERANT



Electricity or Gas or Hybrid? Advanced VRF technologies offering optimal choice and flexibility for our customers.

ECO i ECO G

GHP + EHP HYBRID VRF SYSTEM



Design flexibility.

- Maximum piping length of up to 1000 m\*
  - Extreme operating range, with heating down to -25 °C\*
  - Wide selection of indoor units, including premium nanoe™ X for improved indoor air quality, ERV, AHU control and hydronic options
  - Seamless connectivity with a variety of standalone, central, multi-site control solutions and BMS integration options
- \*Model-dependent.

Complete ECOi solution

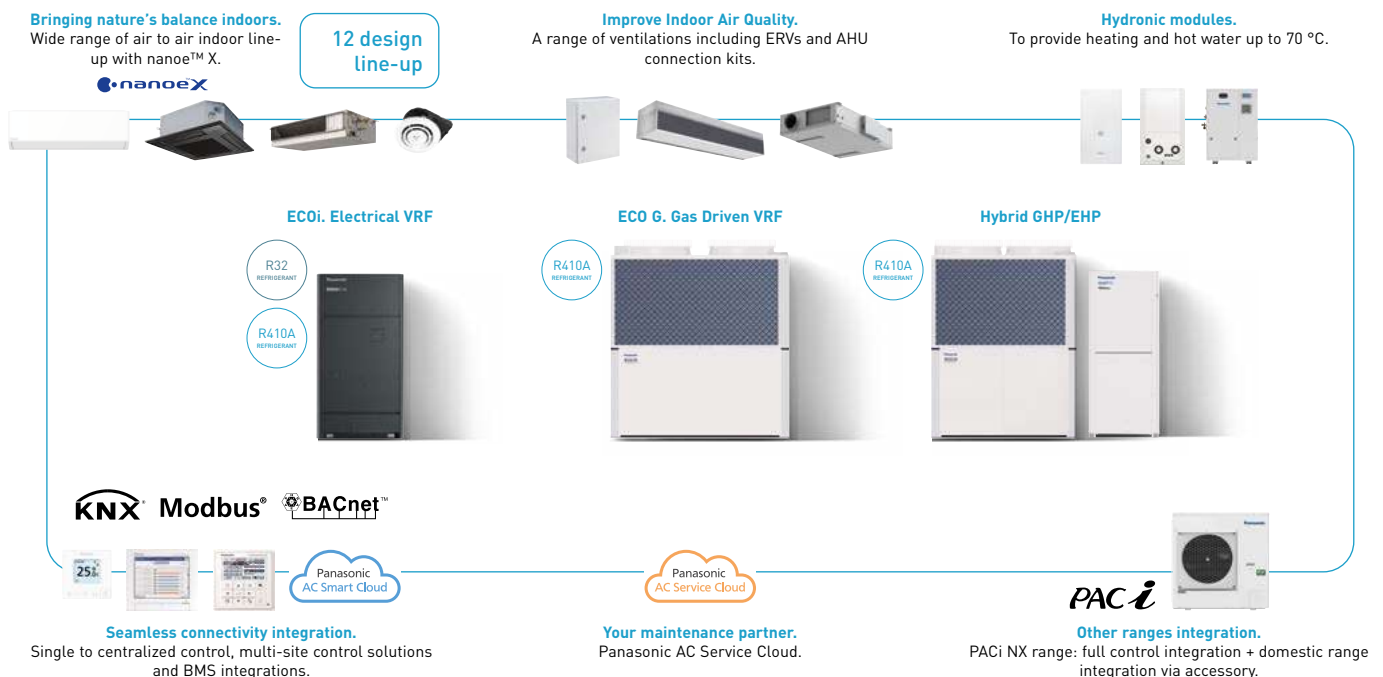

## Panasonic VRF: TOP in comfort

Since 2006, all Panasonic VRF systems have included special VET technology, with variable refrigerant temperature control, as standard.



### Variable Evaporation and Condensation Temperature.

Our 'smart logic' system checks the temperature every 30 seconds, automatically adjusting the refrigerant temperature according to actual demand and outdoor conditions. This ensures better energy performance at all times.

### Temperature varies from 16 °C to 3 °C.

Similarly, the condensation temperature is also variable and is adjusted to the room thermal load, within a range of 33 - 55 °C.

Refrigerant evaporation temperature (°C).

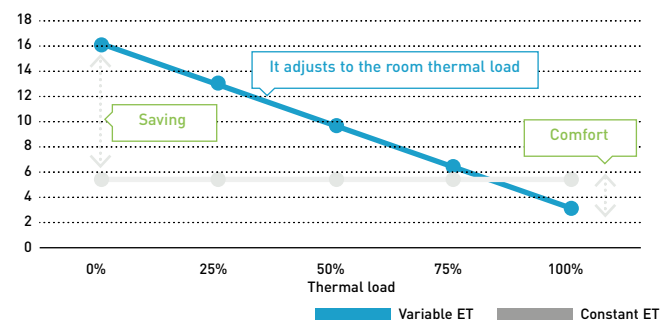

Refrigerant condensation temperature (°C).

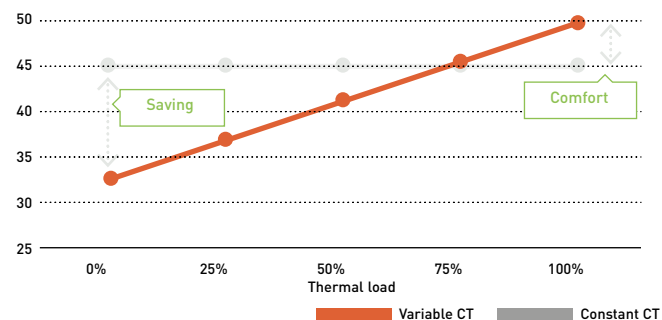

### Example of cooling mode (similarly applicable to heating mode).

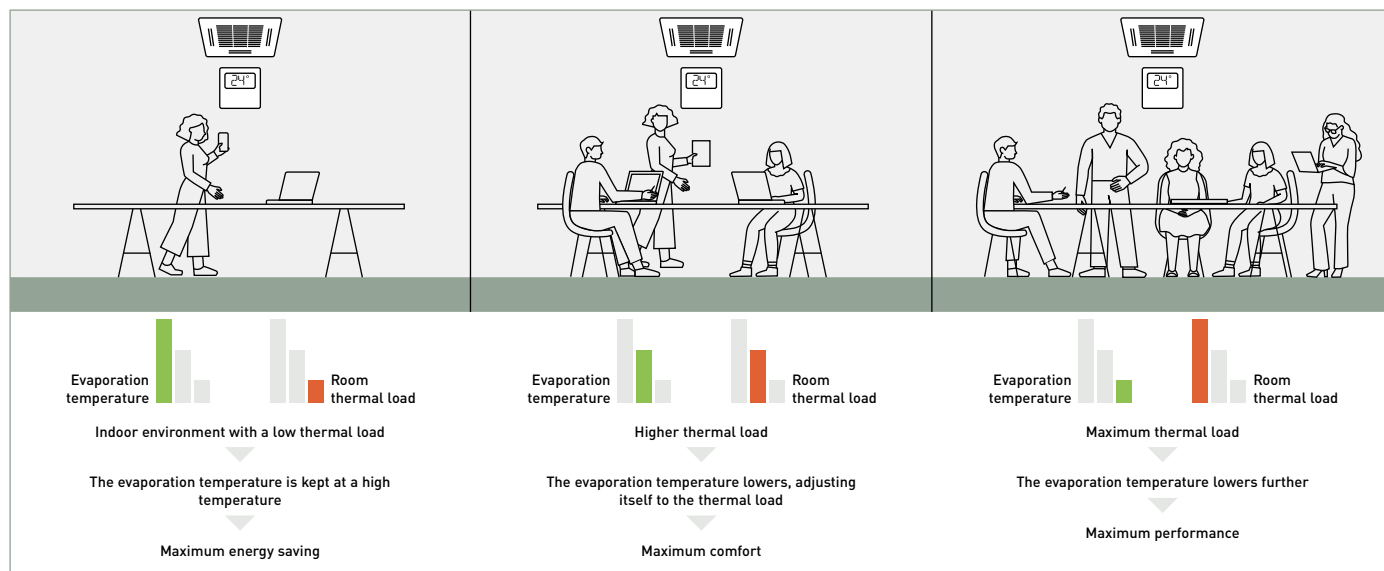

### Technical focus on variable temperatures

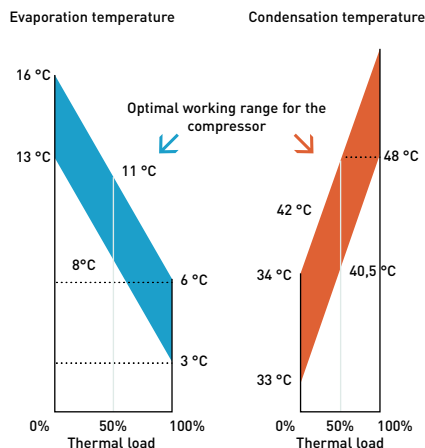

### Control of the discharge temperature

This special function is available in all of Panasonic VRF systems' indoor units to guarantee maximum comfort for the end user. For example, in cooling mode, if the temperature of the discharged air was below 10 °C, the user may feel discomfort, just as he would do in heating mode if the temperature was far too high. With the Panasonic control of the discharge air temperature, this can be adjusted within a cooling range of 7 - 22 °C.

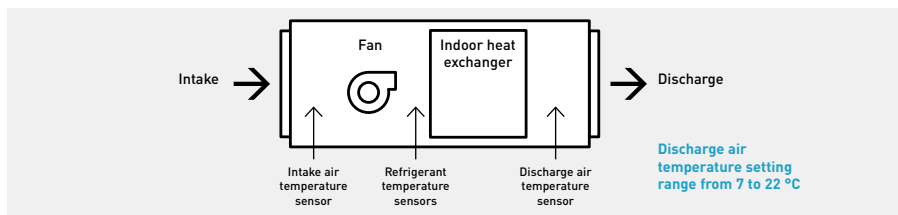

### Benefits:

- The air will never be too cold or too warm
- Available in cooling and in heating
- Higher comfort
- Energy saving
- It prevents the formation of condensation within ducts and vents, improving levels of hygiene

# Bringing nature's balance indoors



## nanoe™ X, technology with the benefits of hydroxyl radicals.

Abundant in nature, hydroxyl radicals (also known as OH radicals) have the capacity to inhibit pollutants, viruses, and bacteria to clean and deodorise. nanoe™ X technology can bring these incredible benefits indoors so that hard surfaces, soft furnishings, and the indoor environment can be a cleaner and more pleasant place to be, whether at home, work, or visiting hotels, shops and restaurants etc.



### What is unique about nanoe™ X?

**Effective on fabrics and surfaces.**

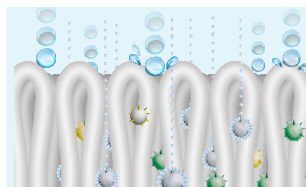

1 | At one billionth of a metre, nanoe™ X is much smaller than steam and can deeply penetrate cloth fabrics to deodorise.

**Longer lifespan.**



2 | Contained in tiny water particles, nanoe™ X has a long lifespan, which is about 600 seconds, to spread easily around the room.

**Huge quantity.**



3 | nanoe X Generator Mark 3 produces 48 trillion hydroxyl radicals per second. Greater amounts of hydroxyl radicals contained in nanoe™ X lead to higher performance on inhibition of pollutants.

**Maintenance-free.**



The image shows nanoe X Generator Mark 3.

4 | No service and maintenance required. nanoe™ X is a filter free solution that does not require maintenance, as its atomisation electrode is enveloped with water during its generation process and it is made with Titanium.

### 7 effects of nanoe™ X – Panasonic unique technology

**Deodorises**

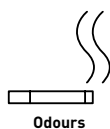

Odours

**Capacity to inhibit 5 types of pollutants**

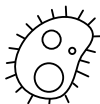

Bacteria and viruses



Mould



Allergens



Pollen



Hazardous substances



Skin and hair

\* Refer to <https://aircon.panasonic.eu> for more details and validation data.

### First nanoe™ device was developed by Panasonic in 2003

**Generator: nanoe™**

2003

480 billion hydroxyl radicals/sec

**Ion particle structure**

Hydroxyl radicals

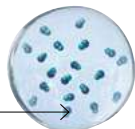

**Generator: nanoe™ X**

**Mark 1 - 2016**

4,8 trillion hydroxyl radicals/sec

10x times

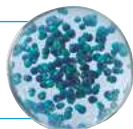

**Mark 2 - 2019**

9,6 trillion hydroxyl radicals/sec

20x times

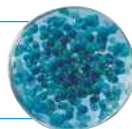

**Mark 3 - 2022**

48 trillion hydroxyl radicals/sec

100x times

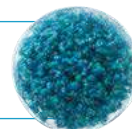



## nanoe™ X has evolved again - the nanoe X Generator Mark 3.

The latest of the continuously evolving nanoe™ X technology, it has the largest amount of hydroxyl radical in the history of nanoe™ which generates 48 trillion hydroxyl radical per second, 100 times the hydroxyl radical contained in traditional nanoe™. The increased number of hydroxyl radical, which are the key to nanoe™ cleaning power, means you can expect an even higher level of performance.



### Licensed in VDI 6022

Certification of a HVAC system under VDI 6022 guarantees that the system fulfills the market's strictest hygiene requirements.

	<b>VDI 6022 – Part 5 <sup>1)</sup> Certification.</b>		<b>VDI 6022 – Part 1 <sup>1)</sup> &amp; 1.1 <sup>2)</sup> Certification.</b>
	<b>Avoidance of allergenic exposure.</b>		<b>Ventilation and indoor-air quality.</b>
	Inhibits a wide range of harmful bacteria, viruses, mould, pollen and allergens.		Panasonic nanoe™ X technology improving indoor air quality.
1) Certification mark only valid for nanoe X Generator Mark 3. 2) Certification mark only valid for nanoe X Generator Mark 2 and Mark 3.			

### Higher concentration, even in large spaces

Greater effectiveness even in large spaces of more than 100 m<sup>2</sup>.

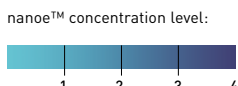

nanoe™ X diffuse into the space in a short time to quickly reach the effective concentration level.

Conditions of the simulation:  
 Inspection / model: 4 way cassette  
 / room size: 112 m<sup>2</sup> / room height: 2,4 m / position of IDU: centre of space / ventilation: 3 times/hour.

### Simulation with nanoe X Generator Mark 3 in a room size of 112 m<sup>2</sup>

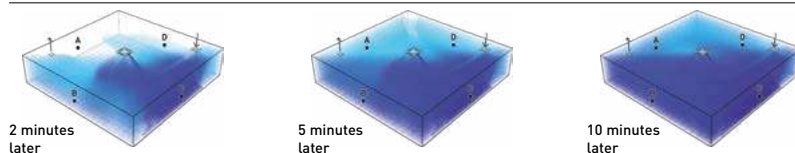

### Effectiveness in large space with Generator Mark 3

#### Inhibits virus.

An air conditioner equipped with nanoe X Generator Mark 3 inhibits activity of adhered virus (Bacteriophage) by 98,81% in 4 hours <sup>1)</sup>.

Test ambient.

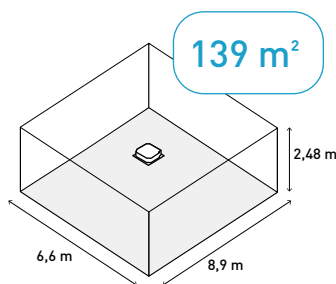

Test result (bacteriophage).

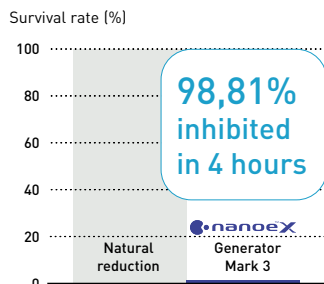

#### Inhibits pollen.

The result of nanoe X Generator Mark 3. Inhibits pollen in 1/4 the time of nanoe X Generator Mark 2 <sup>2)</sup>.

Comparison of time required to inhibit 99% of cedar pollen <sup>3)</sup>.

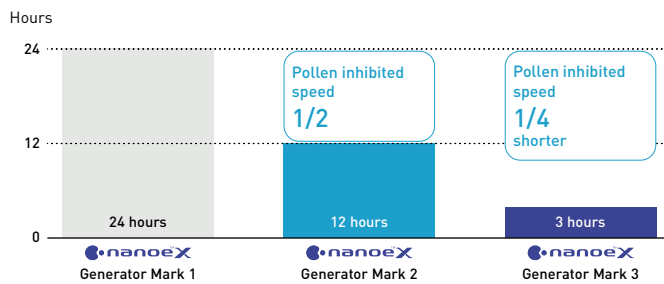

1) Testing organisation: SGS Inc / Test subject: Adhered Bacteriophage / Test volume: Approx. 139 m<sup>2</sup> large space (6,6 x 8,9 x 2,48 m). Test result: Inhibited 98,81% in 4 hours. Test report no.: SHES210901902583.  
 2) Effect after 3 hours in a test space of approx. 24 m<sup>2</sup>. The figures are not the results of testing in an actual operating space. 3) nanoe X Generator Mark 1: [Testing organisation] Panasonic Product Analysis Center [Test method] ELISA method of measuring allergens adhering to fabric in a test room (approx. 24 m<sup>2</sup>) [Method of inhibition] Release of nanoe™ [Target] Adhered allergen (cedar pollen) [Test Result] Inhibition of 99% or more in 24 hours (4AA33-151001-F01). nanoe X Generator Mark 2: [Testing organisation] Panasonic Product Analysis Center, [Test method] ELISA method of measuring allergens adhering to fabric in a test room (approx. 24 m<sup>2</sup>) [Method of inhibition] Release of nanoe™ [Target] Adhered allergen (cedar pollen) [Test Result] Inhibition of 99% or more in 12 hours confirmed (L19YA009). nanoe X Generator Mark 3: [Testing organisation] Panasonic Product Analysis Center [Test method] ELISA method of measuring allergens adhering to fabric in a test room (approx. 24 m<sup>2</sup>) [Method of inhibition] Release of nanoe™ [Target] Adhered allergen (cedar pollen) [Test Result] Inhibition of 99% or more in 3 hours (H21YA017-1).

### Panasonic Heating & Cooling Solutions is incorporating nanoe™ technology in a wide range of equipment

- 
**U2 type 4 way 90x90 cassette.**  
**Built-in nanoe X Generator Mark 3.**
- 
**Y3 type 4 way 60x60 cassette.**  
**Built-in nanoe X Generator Mark 3.**
- 
**K3 type wall-mounted.**  
**Built-in nanoe X Generator Mark 3.**
- 
**F3 type adaptive duct.**  
**Built-in nanoe X Generator Mark 3.**
- 
**M2 type hide-away.**  
**Built-in nanoe X Generator Mark 3.**
- 
**G1 type floor console.**  
**Built-in nanoe X Generator Mark 1.**
- 
**Ceiling mounted air-e nanoe X Generator.**  
**Built-in nanoe X Generator Mark 1.**

## BION air pollutant filter (optional)

Collaborating with BION, experts in filtration equipment, a new molecular filtration is available to improve indoor air quality.





The efficiency of nitrogen dioxide (NO<sub>2</sub>) removal can reach 99,5%\*

\* Measured by ASTM6646 international standards. Efficiency reaches 99,5% within 4,8 seconds of contact time with the media bed (FAM filter). \*\* The performance varies depending on the room size, environment and usage and it may take several hours to reach the full effect. BION air pollutant filter is not medical device, local regulations on building design must be followed. Test results conducted under controlled laboratory conditions. Performance of BION air pollutant filter might differ in real life environment.

**BION air pollutant filter traps and reduces certain types of harmful pollutant gases, listed below**

- Nitrogen oxides (NO<sub>x</sub>)
- Ozone (O<sub>3</sub>)
- Sulfur dioxide (SO<sub>2</sub>)
- Formaldehyde (HCHO)
- Volatile organic compounds (VOCs)

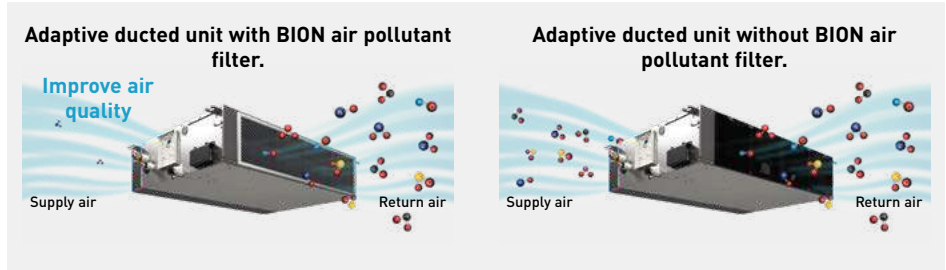

**The BION air pollutant filter is an ideal solution for improving indoor air quality in urban areas.**

**Air pollution in urban areas in Europe**

It is reported that in 2021, a significant portion of the Europe’s urban population has been exposed to high levels of key air pollutants\*.

- 75% of the urban population was exposed to NO<sub>2</sub> concentrations above 10 µg/m<sup>3</sup>
- 94% were exposed to concentrations of O<sub>3</sub> above 60 µg/m<sup>3</sup>

\* The “Europe’s Air Quality Status 2023” report (EEA, 2023) assesses levels of air pollutants measured in ambient air across Europe (> 2000 locations) for the years 2021 and 2022. It compares them against both EU standards as set out in the Ambient Air Quality Directives and the 2021 WHO Air Quality Guidelines.

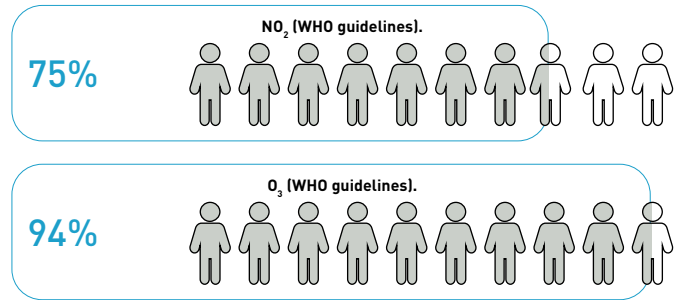

Share of the Europe’s urban population exposed to air pollutant concentrations above EU standards and WHO guidelines in 2021, as referenced in the EEA 2023.

**Why outdoor air pollution matters to IAQ?**

Poor indoor air quality is associated with outdoor air pollutants such as car exhaust and factory fumes, and the two are closely linked. A significant portion of human exposure to air pollution occurs when they are indoors.



**Different objectives, different IAQ solutions**

In today’s world, we are concerned about wellbeing and the air we breathe. And technology exists to ensure improved indoor air quality. With the introduction of the BION air pollutant filter, Panasonic offers IAQ solutions optimized for various target objectives.

IAQ Solution	nanoe™ X	BION air pollutant filter
<b>Objectives</b>	Inhibit particles such as pollutants, certain types of viruses, and bacteria to clean and deodorise	Inhibit gases such as nitrogen oxides (NO <sub>x</sub> ), ozone (O <sub>3</sub> ), sulfur dioxide (SO <sub>2</sub> ), formaldehyde (HCHO) and volatile organic compounds (VOCs)
<b>Technology</b>	Hydroxyl radicals contained in water	Molecular filtration
<b>Filtering mechanism</b>	Physical capture of particles	Adsorption and absorption
<b>Availability</b>	Built into all air-to-air indoor units as a standard	Optional accessory for the adaptive ducted unit (PF3/MF3)

BION air pollutant filter*	PAW-APF800F	PAW-APF1000F	PAW-APF1400F
Compatible adaptive ducted unit	MF3 15, 22, 28, 36, 45 and 56	MF3 60 and 73	MF3 90, 112, 140 and 160

\* The filter cartridge and filter casing are included in the package.

# Solutions for Restaurants

Full heating, cooling and DHW solutions for Restaurants.



## 1a Gas VRF. ECO G.

ECO G gas VRF is designed for buildings where the electricity is restricted or CO<sub>2</sub> emissions must be reduced. Sanitary hot water is produced for free, all year round.



## 1b Electric VRF. ECOi EX and Mini ECOi.

ECOi electrical VRF is specifically designed for the most demanding restaurants. High efficiency system. Extended operating range to provide heating at outdoor temperature as low as -25 °C (2-Pipe ECOi EX). Suitable for refurbishment projects.

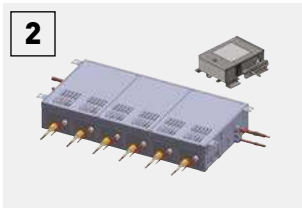

## 2 3-Pipe control box kit.

Heat Recovery box to connect multiple indoor units with just one box, 4, 6 and up to 8 indoor units or groups  
This is good advantage in the restaurants, where space for connecting several boxes is limited.



## 3 Aquarea T-CAP.

Ideal for heating, cooling and for production of big quantities of hot water at 75 °C, Aquarea have a extremely quick return on investment and a low CO<sub>2</sub> footprint.



## 4 Water heat exchanger for ECOi and ECO G. Water up to 55 °C.

Producing hot water, compatible with both ECOi and ECO G, heat pump outdoor units.



## 5 AHU connection kit for efficient ventilation.

The AHU connection kit is specially designed to improve the efficiency of the pre-heating or pre-cooling ventilation process.

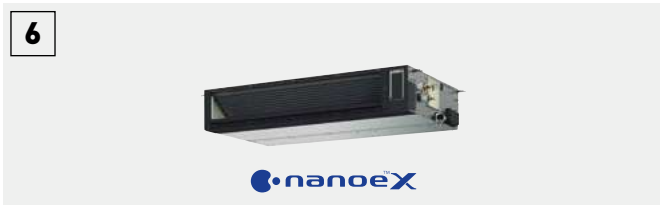

## 6 Adaptive ducted with nanoe™ X.

Super silent units deliver the ideal air supply. Units available from 1,5 kW providing precise temperature control even in small rooms. 2 installation possibilities (horizontal / vertical) with high ESP 150 Pa allows for flexible installation. nanoe™ X is built-in as standard.

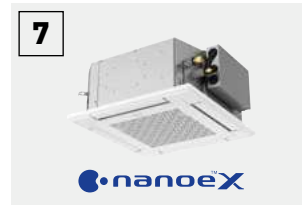

## 7 Mini Cassette.

The Y3 type 4 way 60x60 cassette unit has modern and stylish panel design which matches with any type of the building design.

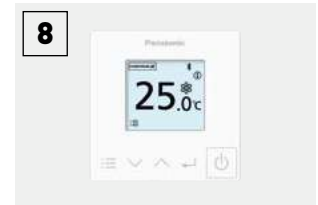

## 8 Control your way.

Wide variety of controls, from simple user control to full system control via remote access functionality. Touch panel and consumption control.



## 9 Air curtain with DX coil.

The Panasonic range of air curtains is designed for smooth operation and efficient performance.



## 10 Protocol friendly.

Great flexibility for integration into your KNX / Modbus / LonWorks / BACnet projects allows fully bi-directional monitoring and control of all the functioning parameters. Range of solutions to control locally or remotely the full system in bi-directional mode.



## 11 Panasonic AC Smart Cloud / Service Cloud.

Taking your business under control. The Service function makes maintenance work simpler.



## 12 Condensing unit with natural refrigerant.

Panasonic CO<sub>2</sub> unit is the natural choice for showcases and cold rooms in restaurants. Always fresh foods from a future-proof refrigeration technology, without any contamination risk.

### Highly efficient at part load conditions.

Panasonic has solutions for optimising the installation of cooling, heating and DHW production in restaurants. While the kitchen needs cooling, heating is needed for DHW and also for heating the public area, with the advantage of 100% fresh air that removes odours. Combining all these needs smartly with Panasonic technology results in a simple and flexible system adaptable to any restaurant requests, with lower utility bills. Additionally, Panasonic is offering the unique solution for areas where electric power is limited, using ECO G. VRF units powered mainly by Natural Gas or Propane, bringing comfort and DHW anywhere.

For chiller options, please check chiller section.

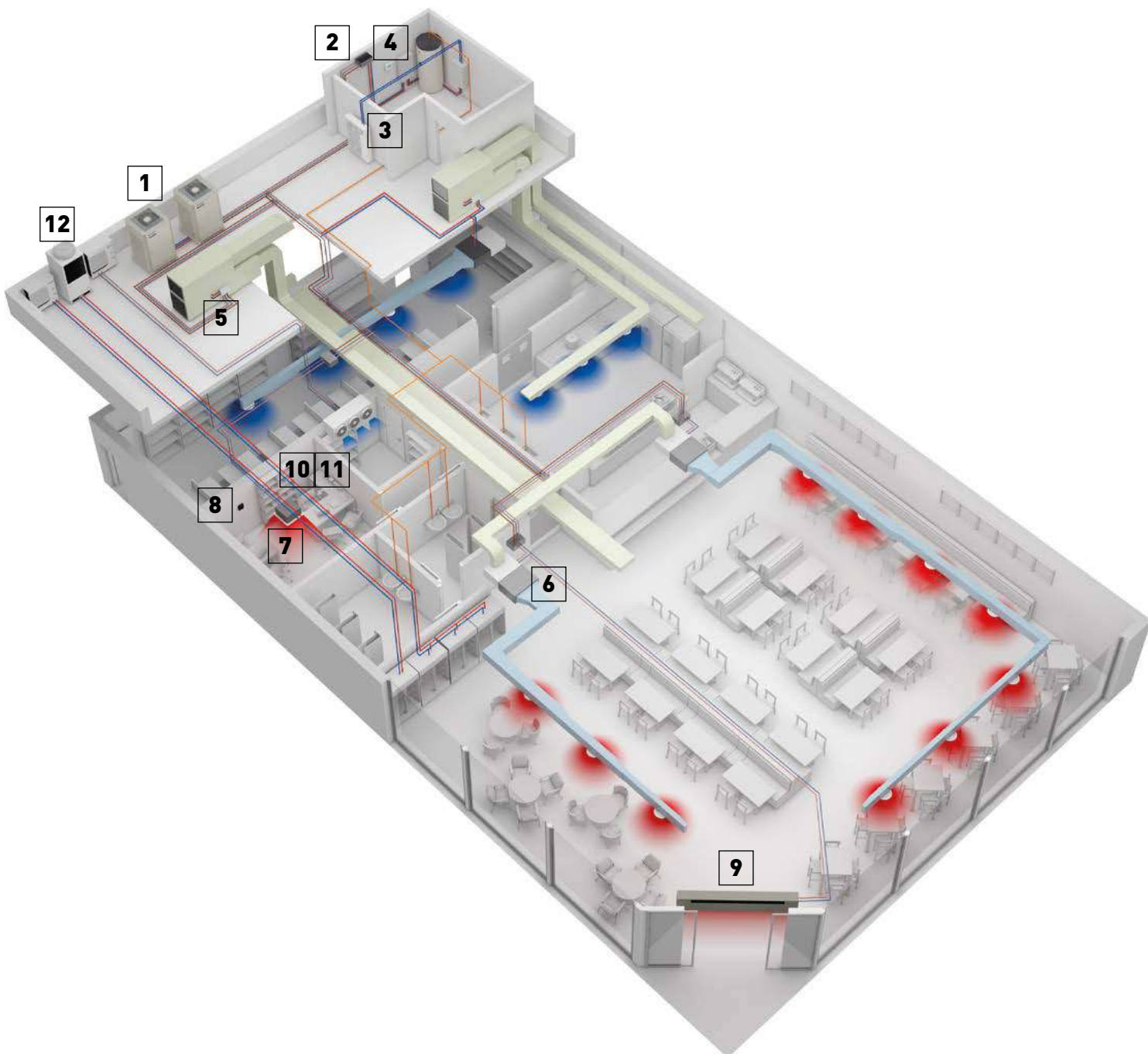

# Your entire hotel with superior comfort, control and savings too

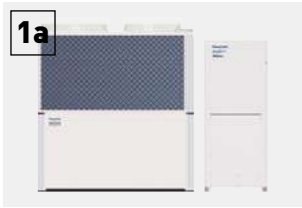

**1a**  
**Hybrid system.**  
 Gas + Electricity Hybrid system. Taking advantage of Gas and Electricity to achieve the most efficient performance and maximum energy saving, whilst reducing reliance on the electricity grid.



**1b**  
**Gas VRF. ECO G.**  
 ECO G gas VRF is designed for buildings where the electricity is restricted or CO<sub>2</sub> emissions must be reduced. Sanitary hot water is produced for free, all year round.



**2**  
**Hydronic units.**  
 Providing hot and cold water for heating and refrigeration (radiators, underfloor heating, radiators...).

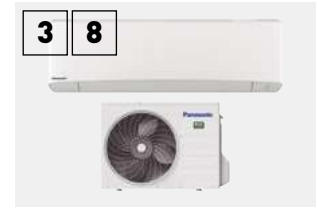

**3 8**  
**YKEA unit for server room.**  
 Steady cooling, nonstop, even at -25 °C and still with high efficiency. Ready for continuous operation and easy to connect 2 systems to automatically alternate and ensure server rooms are kept cool.



**4**  
**AHU connection kit for efficient ventilation.**  
 The AHU connection kit is specially designed to improve the efficiency of the pre-heating or pre-cooling ventilation process.



**5**  
**Electric VRF. ECOi EX.**  
 ECOi electrical VRF is specifically designed for the most demanding hotels. High efficiency system. Extended operating range to provide heating at outdoor temperature as low as -25 °C (2-Pipe ECOi EX). Suitable for refurbishment projects.



**6**  
**Control your way.**  
 Wide variety of controls, from simple user control to full system control via remote access functionality. Touch panel, web server, consumption control, smartphone control... everything is possible.



**7**  
**Wide range of indoor units.**  
 All units provided with supply air temperature sensor and low operation sound level to guarantee maximum guest comfort. Units equipped with nanoe™ X (available in specific models) provide better air quality in public spaces in the hotel.



**8**  
**Panasonic AC Smart Cloud / Service Cloud.**  
 Taking your business under control. The Service function makes maintenance work simpler.



**9**  
**Protocol friendly.**  
 Great flexibility for integration into your KNX / Modbus / LonWorks / BACnet projects allows fully bi-directional monitoring and control of all the functioning parameters.



**10**  
**Air curtain with DX coil.**  
 The Panasonic range of air curtains is designed for smooth operation and efficient performance.

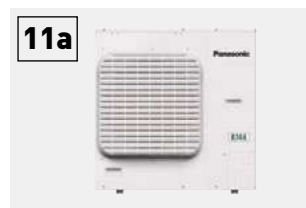

**11a**  
**Condensing unit with natural refrigerant.**  
 Panasonic CO<sub>2</sub> unit is the natural choice for an energy saving and environmentally friendly solution.



**11b**  
**PACi NX Elite Series for cooling rooms.**  
 High quality and efficient solution for high temperature refrigeration applications.



**12**  
**Maximum savings on hot water production.**  
 Hot water for swimming pool, spa and laundry for free thanks to the residual heat generated by the ECO G units.

Panasonic offers the widest range in HVAC, DHW and ventilation available. That enables us to offer the most suitable solution 24 hours a day, 365 days a year. Panasonic Solutions ensure not only a higher customer satisfaction but also a lower energy bill.

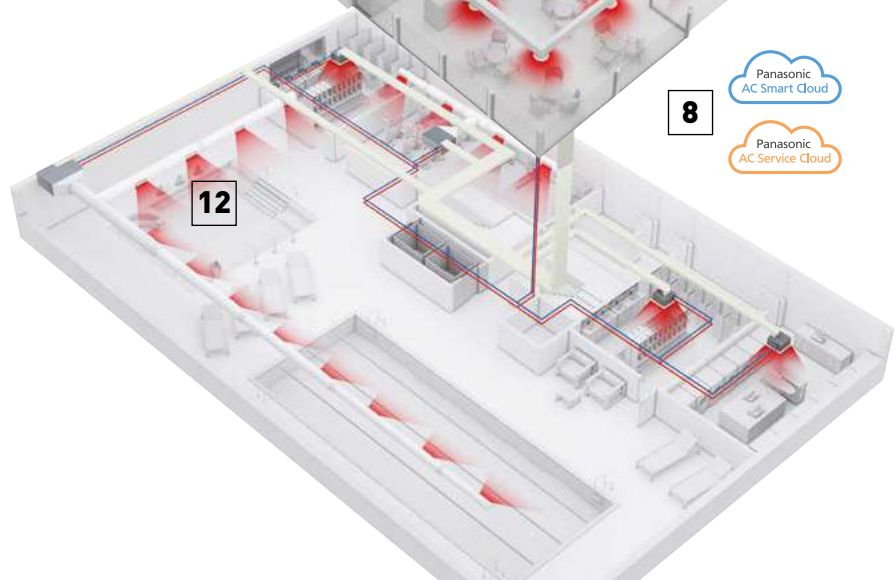
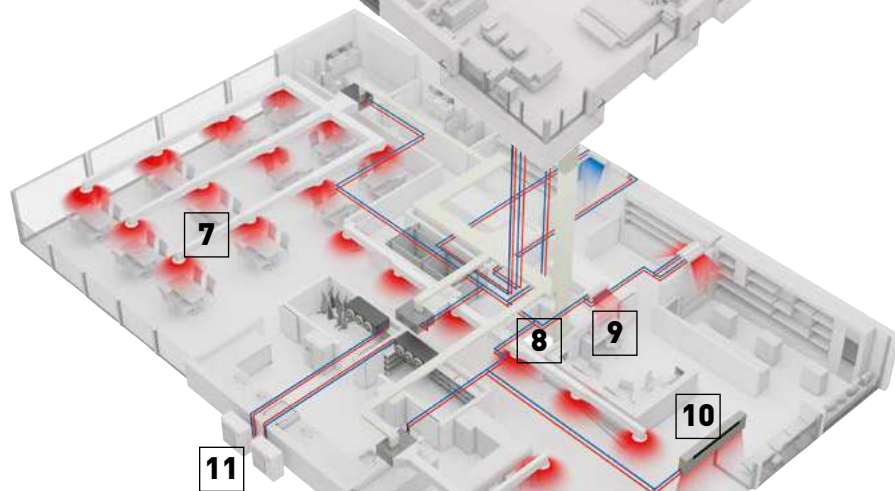
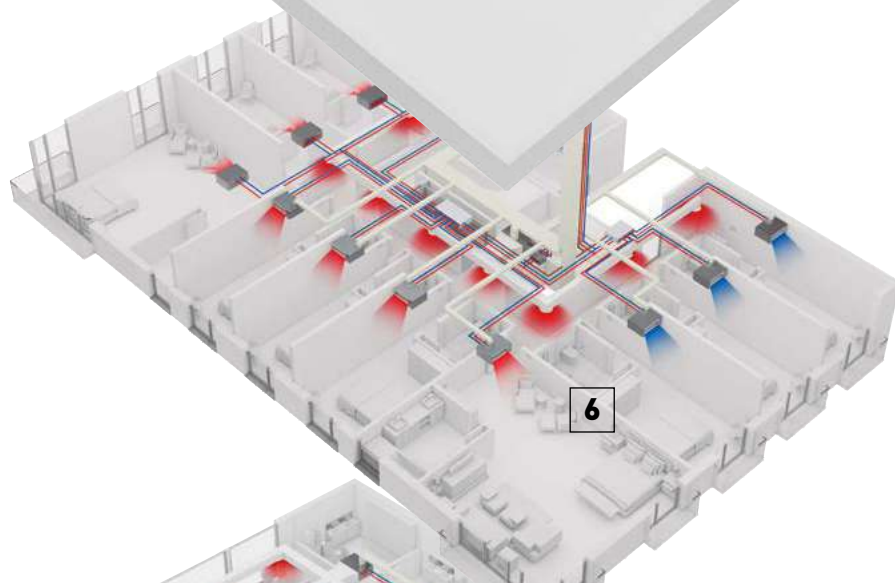
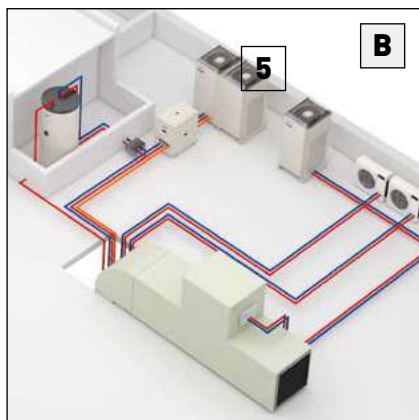
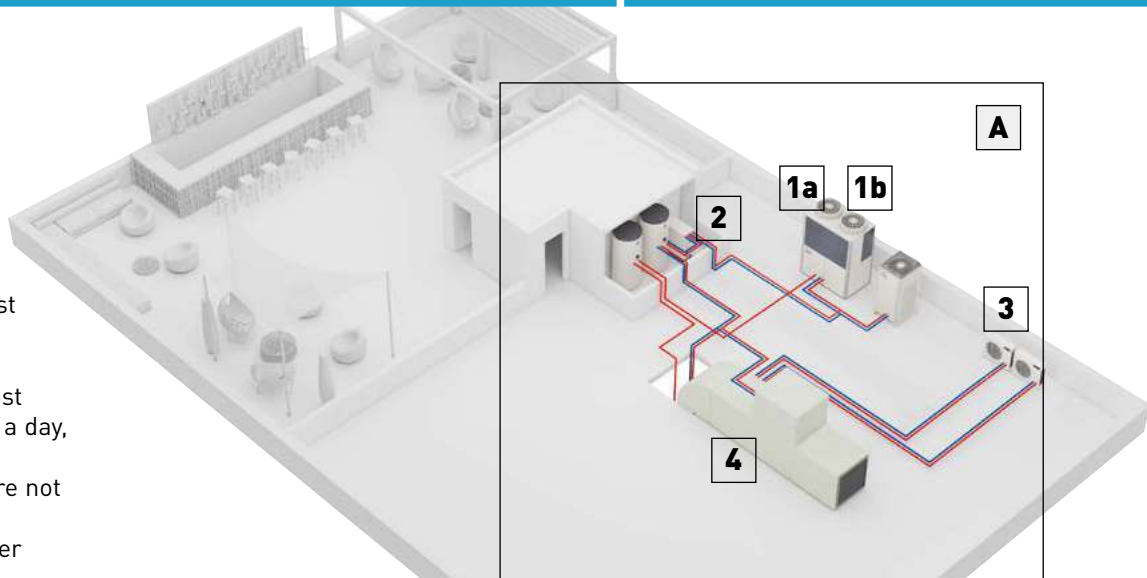

**A**

**Option A: Hybrid solution. Gas + electric:**  
When large quantities of hot/cold water is needed.

- ECO G (gas heat pump)
- Water heat exchanger
- Aquarea HT to produce hot water up to 65 °C
- AHU connection kit to connect the ECO G to the AHU
- YKEA wall-mounted to cool the server rooms efficiently

**B**

**Option B: Full Electric solution 2 and 3-Pipe.** When flexibility is needed and electricity power availability is not an issue.

- ECOi (electric VRF)
- Direct expansion indoor units
- AHU connection kit to connect the ECOi to the AHU
- YKEA wall-mounted to cool the server rooms efficiently
- Panasonic Pump Down system



## Innovative solutions for retail



### Multi energy solutions, gas or electric.

The Multi energy solution (Gas and Electric) from Panasonic provides the best choice in energy saving and on the flexibility of the installation. Panasonic solutions can be connected to direct expansion systems, water chiller installations and ventilation systems as air handling units.

1a: Gas VRF. ECO G

1b: Electric VRF. ECOi

1c: Electric VRF. Mini ECOi

1d: Electric 1x1. PACi NX

1e: Electric A2W. Aquarea



### YKEA unit for server room.

Steady cooling, nonstop, even at -25 °C and still with high efficiency. Ready for continuous operation and easy to connect 2 systems to automatically alternate and ensure server rooms are kept cool.



### Control your way.

Wide variety of controls, from simple user control to full system control via remote access functionality. Touch panel and consumption control.



### Econavi sensor.

The Econavi sensor detects presence in the room, and quietly adapts the PACi or VRF air conditioning system in order to improve comfort and energy savings.

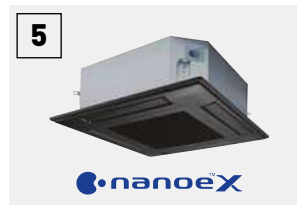

### Wide range of indoor units.

All units provided with supply air temperature sensor and low operation sound level to guarantee maximum guest comfort. Units equipped with nanoe™ X (available in specific models) provide better air quality in public spaces in the hotel.



### Hide-away, for power and efficiency.

Super silent units from 1,0 kW offer precise temperature control for small rooms. M2 type ultra-slim ducted units, only 200 mm high, fit in height-restricted spaces.



### Air curtain with DX coil.

The Panasonic range of air curtains is designed for smooth operation and efficient performance.



### Protocol friendly.

Great flexibility for integration into your KNX / Modbus / LonWorks / BACnet projects allows fully bi-directional monitoring and control of all the functioning parameters. Range of solutions to control locally or remotely the full system in bi-directional mode.



### AHU connection kit for efficient ventilation.

The AHU connection kit is specially designed to improve the efficiency of the pre-heating or pre-cooling process of the ventilation.

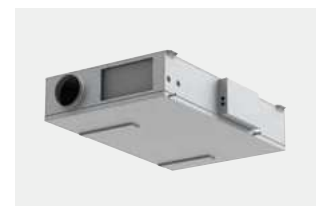

### Energy Recovery unit for high efficiency of the system.

Panasonic Energy Recovery Ventilators can reduce the outside air load because they efficiently recover the heat lost by ventilation during the heat recovery process.



## Heating and cooling solutions for retail applications.

Panasonic has developed solutions for retail and office applications where return on investment is a key factor! The comfort inside the shop is key for a good customer experience.







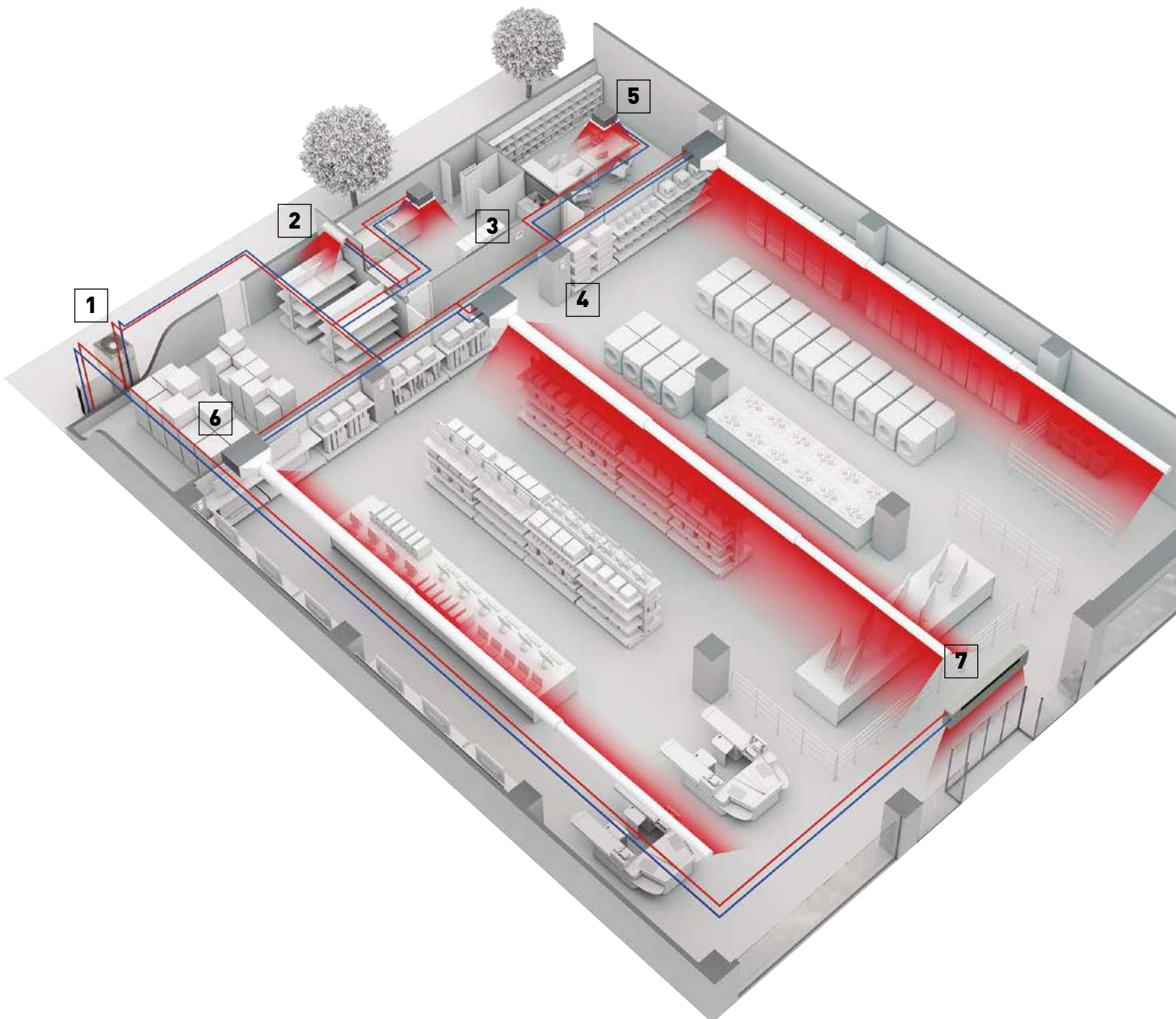













From local control or Panasonic's cloud control system, a detailed status of the heating and cooling system can be displayed, analysed and optimised in order to improve the efficiency, reduce the running time and increase the life time of the units.

### 8 reason why Panasonic is the best solution for your retail:

- Complete solution
- Flexibility and adaptability
- Go green retail: low CO<sub>2</sub> emissions
- Comfort - high customer satisfaction
- Future expansion
- Panasonic offers efficient systems meeting expectations over the life-span of the project
- High quality of service with Panasonic pro-partner installation team
- The system will still operate down to 25% of the connected indoor units. System will not stop when only 25% of indoor units have power supply breakdown when they are on mode



# VRF outdoor units range

Page	Outdoor units	4 HP	5 HP	6 HP	8 HP	10 HP	12 HP
P. 302	 <b>Mini ECOi LZ2 Series · R32</b>						
		U-4LZ2E5 / U-4LZ2E8	U-5LZ2E5 / U-5LZ2E8	U-6LZ2E5 / U-6LZ2E8	U-8LZ2E8	U-10LZ2E8	
P. 306	<b>Mini ECOi LE2 / LE1 Series · R410A</b>						
		U-4LE2E5 / U-4LE2E8	U-5LE2E5 / U-5LE2E8	U-6LE2E5 / U-6LE2E8	U-8LE1E8	U-10LE1E8	
P. 314	 <b>NEW 2-Pipe ECOi EX MZ1 Series · R32</b>						
					U-8MZ1E8	U-10MZ1E8	U-12MZ1E8
P. 320	<b>2-Pipe ECOi EX ME2 Series · R410A</b>						
					U-8ME2E8	U-10ME2E8	U-12ME2E8
P. 328	<b>3-Pipe ECOi EX MF3 Series · R410A</b>						
					U-8MF3E8	U-10MF3E8	U-12MF3E8
P. 338	<b>2-Pipe ECO G GE3 Series · R410A</b>						
P. 342	<b>3-Pipe ECO G GF3 Series · R410A</b>						
P. 344	<b>GHP/EHP Hybrid System · R410A</b>						

14 HP

16 HP

18 HP

20 HP

25 HP

30 HP



U-14ME2E8



U-16ME2E8



U-18ME2E8



U-20ME2E8



U-14MF3E8



U-16MF3E8



U-16GE3E5



U-20GE3E5



U-25GE3E5



U-30GE3E5



U-16GF3E5



U-20GF3E5



U-25GF3E5



U-20GES3E5 / U-10MES2E8

## Best efficiency ECOi Series from Panasonic

The ECOi Series is designed for energy savings, easy installation, and high efficiency. Always continuing to evolve, Panasonic uses advanced technologies to meet the requirements of diverse situations and contribute to the creation of comfortable living spaces.



### Mini ECOi LZ2 Series · R32.

#### From 4 to 10 HP.

The Mini ECOi LZ2 Series utilizes environmentally friendly R32 refrigerant, reducing the total amount of refrigerant by 20% and more, resulting in lower GWP, reduced by 75%\*.

\* As a result of applying R32 while at the same time reducing the total refrigerant amount.



R32  
REFRIGERANT

### New 2-Pipe ECOi EX MZ1 Series · R32.

#### From 8 to 48 HP.

The next generation in energy efficiency and versatility for commercial applications.



R32  
REFRIGERANT

### Mini ECOi LE Series · R410A.

#### From 4 to 10 HP.

The 2-Pipe heat pump small VRF system specifically designed for the European market.



### 2-Pipe ECOi EX ME2 Series · R410A.

#### From 8 to 80 HP.

The VRF system delivering energy-saving performance, powerful operation, reliability and comfort surpassing anything previously possible.



### 3-Pipe ECOi EX MF3 Series · R410A.

#### From 8 to 48 HP.

The VRF system that offers high-efficiency and performance for simultaneous heating and cooling.



ECOi R32 - Extended decarbonised solution. Minimize environmental impact.

R32  
GWP REDUCED BY  
**68%**<sup>1)</sup>

Refrigerant amount  
**-57%**<sup>2)</sup>



The ECOi Series with R32 refrigerant has been expanded to minimise the environmental impact of VRF systems for the decarbonised buildings. Advanced R32 technology and optimised design make it a more sustainable alternative to R410A. With lower GWP and superior efficiency, it ensures sustainability throughout its lifetime.

<sup>1)</sup> GWP of R32 refrigerant is 675, while the GWP of R410A is 2088. <sup>2)</sup> Panasonic's internal research. Refrigerant amount reduction compared to the R410A equivalent system. 12 HP model with 30 m piping installation.



**Sustainable yet highly efficient.**

Benefit from a substantial 68%<sup>1)</sup> reduction in Global Warming Potential (GWP) and up to 82%<sup>3)</sup> total CO<sub>2</sub> Eq reduction thanks to decreased refrigerant volume, all while boosting overall efficiency.

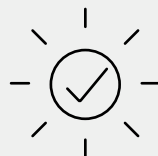

**Reliability - R32 standard-compliant.**

Panasonic offers safety measures such as a leak detector, alarm, and safety valve kit, compliant with the latest standards. These are designed to meet requirements based on R32 refrigerant density under specific project conditions.

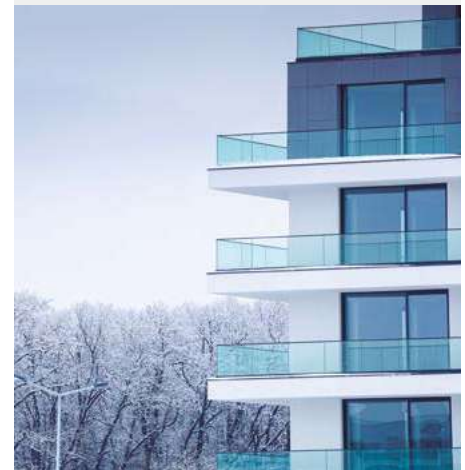

**Design flexibility.**

Maximum piping length of up to 1000 m.  
Extreme operating range, with heating down to -25 °C.  
Wide selection of indoor units, including premium nanoe™ X for improved indoor air quality.  
Seamless connectivity with a variety of standalone, central, cloud and BMS integration options.

<sup>1)</sup> GWP of R32 refrigerant is 675, while the GWP of R410A is 2088. <sup>2)</sup> Panasonic's internal research. Refrigerant amount reduction compared to the R410A equivalent system. 12 HP model with 30 m piping installation. <sup>3)</sup> Total CO<sub>2</sub> Eq= GWP x charge. Panasonic's internal research conducted under consistent system conditions.

High performance of Panasonic's ECOi Series is verified by Eurovent now!

Detailed data in page 392.



# Mini ECOi LZ2 Series R32

Outstanding efficiency in a compact body and continuous operation even at extreme ambient temperatures. VRF with outstanding energy-saving performance and superior SEER and SCOP.



<p><b>SEER SCOP</b> 8,50 <sup>1)</sup> 5,05 <sup>1)</sup></p>			
<p><b>Extraordinary savings.</b></p>	<p><b>Reliable quality - R32 standard-compliant <sup>2)</sup>.</b></p>	<p><b>Panasonic DNA compressors.</b></p>	<p><b>Low height 996 mm.</b></p>
<p><b>HIGH ESP</b></p>			
<p><b>High external static pressure 35 Pa.</b></p>	<p><b>Quiet mode operation with low capacity drop.</b></p>	<p><b>Continuous operation at extreme ambient temperatures.</b></p>	<p><b>Increased indoor / outdoor capacity ratio up to 150%.</b></p>

<sup>1)</sup> for 4 HP model. <sup>2)</sup> Panasonic's R32 safety measures comply with IEC 60335-2-40 (ed. 7.0) and EN 378 (ISO 5149).

Mini ECOi LZ2 provides the optimal performance in any climatic condition.

Extended design operation conditions

LZ2 mini VRF is extremely reliable even under the most difficult conditions. The units can operate in cooling mode at extreme temperatures, 52 °C in cooling and -20 °C in heating mode.

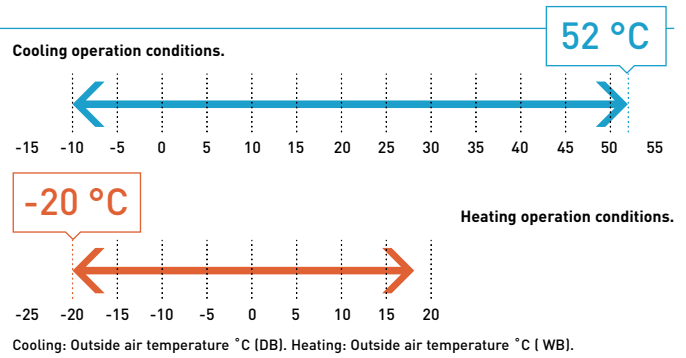

Compatible with a large range of indoor units and controls

An expansion of Panasonic VRF line up, the Mini ECOi R32 is compatible with a large range of indoor units, either supporting Panasonic's optional R32 refrigerant leak detector alarm or having built-in detectors provide a great flexibility for all types of installation, and can utilize all Panasonic's scalable control and monitoring solutions.

Connects R32 refrigerant leak detector - CZ-CGLSC2



Built-in R32 sensors

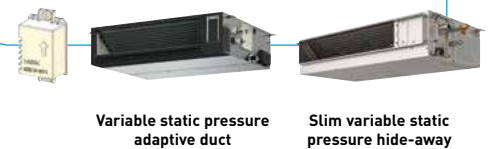

Panasonic R32 refrigerant leak detector/alarm (optional)

The optional R32 refrigerant leak detector (CZ-CGLSC2) is available for compatible indoor units, allowing customers to determine if the detector is required for safety compliance or if the indoor unit can be installed without it. This sensor includes an integrated alarm buzzer and can connect to a central alarm system. It links to the indoor unit's remote control terminals and is compatible with any VRF remote controllers, wired or wireless.



The alarm triggered by the Panasonic R32 refrigerant leak detector will also be transmitted and displayed on any connected centralised controller.

\* Only one remote controller can be connected with the Panasonic R32 refrigerant leak detector.



Non-voltage contact external output, maximum allowable voltage: DC 24 V (for central monitoring, etc.).

R32 Pump Down solution

R32 Pump Down solution offers the assurance of additional safety protection, whilst expanding the potential installation cases, allowing for installation within smaller rooms.

Suitable for the Mini ECOi LZ2 range up to 10 HP, compatible indoor units connected to CZ-CGLSC2 or integrated Panasonic R32 refrigerant leak detector.

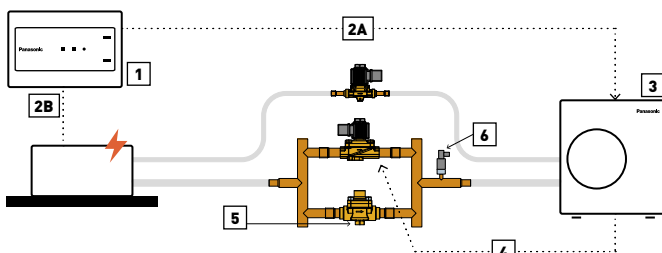

Operation steps: 1 | A leak is detected by the leak detection sensor. 2A | Leak alarm signal is sent to the outdoor unit. 2B | Indoor unit fan activated and runs at maximum speed. 3 | Pump Down procedure is activated. 4 | Solenoid valves are closed preventing refrigerant returning to indoor units. 5 | Outdoor unit is operating in Pump Down mode and check valve only allows flow to the outdoor unit. 6 | Low pressure switch threshold is reached. Error signal isolates the outdoor unit, preventing restart.

Technical focus

- Simplified design and installation
- Complies with IEC 60335-2-40 ed.6.0
- Recovers base charge within outdoor unit
- Expands potential installation cases
- IP rated connections for outdoor installation

Model reference	Description
PAW-PUD2WB-1	Basic Pump Down system (2 way) for one R32 Mini ECOi outdoor unit

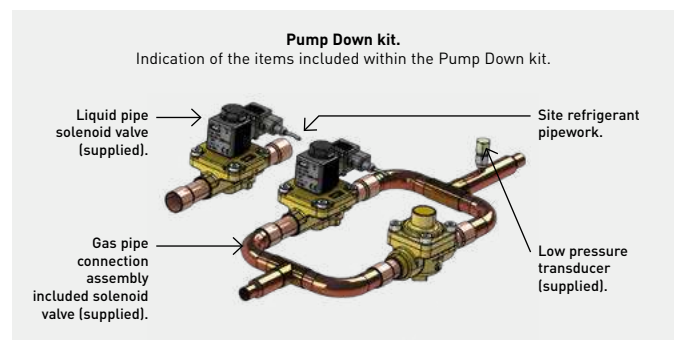

## Mini ECOi LZ2 Series 4 to 6 HP · R32

**Outstanding efficiency in a compact body and continuous operation even at extreme ambient temperatures.**

- SEER levels up to 8,5 and SCOP levels up to 5,0 (for 4 HP model)
- Continuous operation at extreme ambient temperatures: -20 °C (heating) to 52 °C (cooling)
- Unique indoors with nanoe™ X, hydroxyl radicals contained in water

Low height  
996 mm



HP			4 HP	5 HP	6 HP	4 HP	5 HP	6 HP
Outdoor unit			U-4LZ2E5	U-5LZ2E5	U-6LZ2E5	U-4LZ2E8	U-5LZ2E8	U-6LZ2E8
Power supply	Voltage	V	220-230-240	220-230-240	220-230-240	380-400-415	380-400-415	380-400-415
	Phase		Single phase	Single phase	Single phase	Three phase	Three phase	Three phase
	Frequency	Hz	50	50	50	50	50	50
Cooling capacity		kW	12,1	14,0	15,5	12,1	14,0	15,5
EER <sup>1)</sup>		W/W	4,53	4,12	3,88	4,53	4,12	3,88
Current		A	13,30-12,80-12,20	16,90-16,20-15,50	19,60-18,70-18,00	4,37-4,15-4,00	5,50-5,23-5,04	6,44-6,12-5,89
Input power		kW	2,67	3,40	4,00	2,67	3,40	4,00
Heating capacity		kW	12,5	16,0	16,5	12,5	16,0	16,5
COP <sup>1)</sup>		W/W	5,27	4,71	4,42	5,27	4,71	4,42
Current		A	12,00-11,40-11,00	16,90-16,20-15,50	18,50-17,70-17,00	3,91-3,71-3,58	5,50-5,22-5,03	6,02-5,72-5,51
Input power		kW	2,37	3,40	3,73	2,37	3,40	3,73
Starting current		A	1,0	1,0	1,0	1,0	1,0	1,0
Maximum current		A	19,6	23,7	26,5	7,2	9,2	9,9
Maximum input power		kW	3,92-4,10-4,28	4,76-4,98-5,19	5,41-5,66-5,90	4,40-4,63-4,80	5,69-5,99-6,22	6,15-6,47-6,72
Maximum number of connectable indoor units <sup>2)</sup>			7(10)	8(12)	9(12)	7(10)	8(12)	9(12)
External static pressure		Pa	0-35	0-35	0-35	0-35	0-35	0-35
Air flow		m <sup>3</sup> /min	69	72	74	69	72	74
Sound pressure	Cool	dB(A)	52	53	54	52	53	54
	Cool (Silent 1/2/3/4)	dB(A)	49/47/45/45	50/48/46/45	51/49/47/45	49/47/45/45	50/48/46/45	51/49/47/45
	Heat	dB(A)	54	56	56	54	56	56
Sound power	Cool / Heat	dB(A)	69/72	70/74	72/75	69/72	70/74	72/75
Dimension	HxWxD	mm	996x980x370	996x980x370	996x980x370	996x980x370	996x980x370	996x980x370
Net weight		kg	94	94	94	94	94	94
Piping diameter	Liquid	Inch (mm)	3/8(9,52)	3/8(9,52)	3/8(9,52)	3/8(9,52)	3/8(9,52)	3/8(9,52)
	Gas	Inch (mm)	5/8(15,88)	5/8(15,88)	5/8(15,88)	5/8(15,88)	5/8(15,88)	5/8(15,88)
Maximum piping length (total)		m	90(180)	90(180)	90(180)	90(180)	90(180)	90(180)
Elevation difference (in / out)		m	50(OU above)/ 40(OU below)	50(OU above)/ 40(OU below)	50(OU above)/ 40(OU below)	50(OU above)/ 40(OU below)	50(OU above)/ 40(OU below)	50(OU above)/ 40(OU below)
Refrigerant (R32)		kg	2,7	2,7	2,7	2,7	2,7	2,7
Maximum allowable indoor / outdoor capacity ratio <sup>3)</sup>		%	50-150(130)	50-150(130)	50-150(130)	50-150(130)	50-150(130)	50-150(130)
Operating range	Cool Min - Max	°C	-10-52	-10-52	-10-52	-10-52	-10-52	-10-52
	Heat Min - Max	°C	-20-18	-20-18	-20-18	-20-18	-20-18	-20-18

### ErP data<sup>4)</sup>

SEER <sup>5)</sup>	8,50	8,12	7,71	8,50	8,12	7,71
$\eta_{s,c}$	337,0%	321,8%	305,4%	337,0%	321,8%	305,4%
SCOP <sup>5)</sup>	5,05	4,61	4,59	5,05	4,61	4,59
$\eta_{s,h}$	199,0%	181,4%	180,6%	199,0%	181,4%	180,6%

1) EER and COP calculation is based in accordance to EN 14511. 2) The number in parenthesis indicates maximum number of connectable indoor unit in case of 1,5 kW indoor units connection. 3) The number in parenthesis indicates maximum allowed indoor / outdoor capacity ratio in case of 1,5 kW indoor units connection. 4) SEER / SCOP and  $\eta_{s,c}$  /  $\eta_{s,h}$  are in accordance with ErP test data for U2 type 4 way 90x90 cassette indoor units. 5) SEER / SCOP is calculated based on the seasonal space cooling / heating efficiency "η" values of the COMMISSION REGULATION (EU) 2016/2281. SEER, SCOP = (η + Correction) × PEF.

### Minimum environmental impact

Panasonic has designed the LZ2 series in order to minimize the environmental impact of the system. Low GWP refrigerant R32 and highest efficiency levels ensure this through the total operational lifetime.

### For the most challenging spaces

The Mini ECOi LZ2 R32 VRF system is the ideal solution to fit into any application thanks to its compact design and long piping lengths.

### Technical focus

- Widest range of connectable units in R32 VRF
- Allowing wide range of installations with and without mitigation measures
- Flexible mitigation measures, with Panasonic R32 refrigerant leak detector / alarm to be installed only when required



INTERNET CONTROL: Optional.





## Mini ECOi LZ2 Series 8 and 10 HP · R32

### Introducing widest range of R32 Mini VRF.

- SEER levels up to 7,6 and SCOP levels up to 4,6 (for 8 HP model)
- Continuous operation at extreme ambient temperatures: -20 °C (heating) to 52 °C (cooling)
- Unique indoors with nanoe™ X, hydroxyl radicals contained in water

Industry 1st 8 HP  
and 10 HP Mini VRF  
units with R32



HP			8 HP	10 HP
Outdoor unit			U-8LZ2E8	U-10LZ2E8
Power supply	Voltage	V	380 - 400 - 415	380 - 400 - 415
	Phase		Three phase	Three phase
	Frequency	Hz	50	50
Cooling capacity		kW	22,4	28,0
EER <sup>1)</sup>		W/W	3,84	3,47
Current		A	9,73 - 9,25 - 8,91	13,2 - 12,5 - 12,1
Input power		kW	5,83	8,07
Heating capacity		kW	25,0	28,0
COP <sup>1)</sup>		W/W	4,30	4,47
Current		A	9,81 - 9,32 - 8,98	10,5 - 9,93 - 9,57
Input power		kW	5,81	6,26
Starting current		A	1,0	1,0
Maximum current		A	13,7	19,5
Maximum input power		kW	8,21 - 8,64 - 8,96	11,9 - 12,6 - 13,0
Maximum number of connectable indoor units <sup>2)</sup>			16	16
External static pressure		Pa	0 - 35	0 - 35
Air flow		m <sup>3</sup> /min	158	167
Sound pressure	Cool	dB(A)	59,0	60,0
	Cool (Silent 1/2/3/4)	dB(A)	56/54/52/50	57/55/53/50
Sound power	Cool	dB(A)	72	74
Dimension	H x W x D	mm	1500 x 980 x 370	1500 x 980 x 370
Net weight		kg	125	126
Piping diameter	Liquid	Inch (mm)	3/8(9,52)	3/8(9,52)
	Gas	Inch (mm)	3/4(19,05)	7/8(22,22)
Maximum piping length (total)		m	100(300)	100(300)
Elevation difference (in / out)		m	50(OU above)/40(OU below)	50(OU above)/40(OU below)
Refrigerant (R32)		kg	4,9	5,1
Maximum allowable indoor / outdoor capacity ratio <sup>3)</sup>		%	50 - 150(130)	50 - 150(130)
Operating range	Cool Min ~ Max	°C	-10 - 52	-10 - 52
	Heat Min ~ Max	°C	-20 - 18	-20 - 18
<b>ErP data <sup>4)</sup></b>				
SEER <sup>5)</sup>			<b>7,56</b>	<b>7,08</b>
$\eta_{s,c}$			<b>299,4%</b>	<b>280,2%</b>
SCOP <sup>5)</sup>			<b>4,59</b>	<b>4,60</b>
$\eta_{s,h}$			<b>180,6%</b>	<b>181,0%</b>

1) EER and COP calculation is based in accordance to EN 14511. 2) The number in parenthesis indicates maximum number of connectable indoor unit in case of 1,5 kW indoor units connection. 3) The number in parenthesis indicates maximum allowed indoor / outdoor capacity ratio in case of 1,5 kW indoor units connection. 4) SEER / SCOP and  $\eta_{s,c}$  /  $\eta_{s,h}$  are in accordance with ErP test data for F2 type variable static pressure hide-away indoor units. 5) SEER / SCOP is calculated based on the seasonal space cooling / heating efficiency "η" values of the COMMISSION REGULATION (EU) 2016/2281. SEER, SCOP = (η + Correction) × PEF.

### Perfect fit for small to medium size projects

8 and 10 HP LZ2 Mini VRF units bring in the total benefits of a VRF system in a smaller application. You can enjoy advanced individual and central VRF control options including the revolutionary Panasonic AC Smart Cloud and AC Service Cloud.

### Technical focus

- Widest range of connectable units in R32 VRF
- Allowing wide range of installations with and without refrigerant mitigation
- Flexible mitigation measures, with Panasonic R32 refrigerant leak detector / alarm to be installed only when required

### For the most difficult conditions

The Mini ECOi LZ2 series are able to operate at the hardest conditions from -20 °C up to +52 °C providing continuous and efficient, heating and cooling for your space all year long.



INTERNET CONTROL: Optional.



# Mini ECOi LE Series R410A

Mini ECOi with extraordinary energy-saving performance and high external static pressure (35Pa).



SEER 7,85 <sup>1)</sup> SCOP 4,87 <sup>1)</sup>

Extraordinary savings.



High Quality - Panasonic twin rotary compressor.



No extra refrigerant needed up to 50 m<sup>2</sup>.

HIGH COP

High COP mode option <sup>2)</sup>.



Low height 996 mm.

HIGH ESP

High external static pressure 35 Pa.

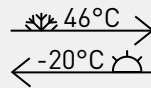

Continuous operation at extreme ambient temperatures.

130% ↑

Increased indoor / outdoor capacity ratio up to 130%.

<sup>1)</sup> for 4 HP model. <sup>2)</sup> For model 4-6 HP.

### High external static pressure 35 Pa.

- High air pressure
- An efficient blade design
- Perfect for high class condominiums

When unit is installed on a narrow balcony and exposed to the sun, the barrier at the front side may restrict hot air from being discharged. Heat accumulated in an enclosure can cause over-heating. This may potentially result in damage or shorten the product's life span. A high external static pressure fan sends the air further away from the outdoor unit and through the barrier. This provides better air circulation and distribution. And a high air pressure of 35 Pa discharges the hot air to a sufficient distance.

#### Previous model - low pressure.

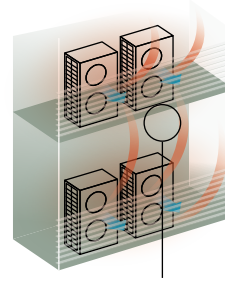

**Heat accumulated.**  
When the pressure is low, hot air will accumulate in the unit thus affecting its work performance and that of unit above it as well.



Previous fan

#### LE Series - high pressure.

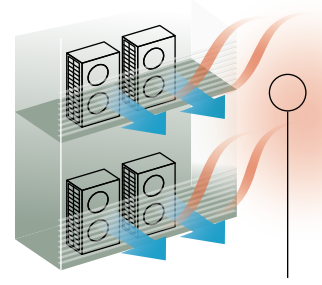

**Heat discharged.**  
But with a high pressure of 35 Pa, hot air is sent further away preventing overheating inside the outdoor unit enclosure.



LE2's fan

### Energy control and reliability

The Mini ECOi system delivering energy-saving performance, powerful operation, reliability and comfort surpassing anything previously possible.



#### Powerful heat exchanger.

3 layers of heat exchanger for all LE Series. LE Series features the same heat exchange volume as conventional model even though it is 15% smaller in size.



#### Panasonic twin rotary compressor.

A large capacity Inverter compressor has been adopted. This compressor features wider and 0,1 Hz step Inverter control.



#### Design fan.

Fan blades have been redesigned to inhibit air resistance and to increase efficiency. The larger fan increases air flow while maintaining low noise levels.

### Energy savings design

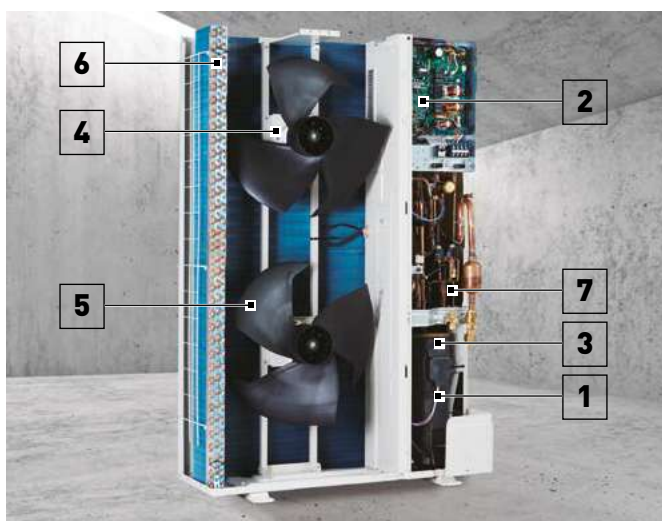

- 1 | Panasonic Inverter compressor.** A large-capacity Inverter compressor has been adopted. The Inverter compressor is superior in performance with improved partial-load capacity.
- 2 | Printed circuit board.** Maintenance is made easier with only 2 PCBs.
- 3 | Accumulator.** A large accumulator has been adopted to maintain compressor reliability because of the increased refrigerant quantity, which allows an extended maximum piping length.
- 4 | DC fan motor.** Checking load and outside temperature, the DC motor is controlled for optimum air flow.
- 5 | Blade shape.** The fan blades have been developed to inhibit air turbulence and increase efficiency. As the fan diameter has been increased, air flow has also increased whilst maintaining a same sound level.
- 6 | Heat exchanger and copper tubes.** Optimised heat exchanger and copper tube sizes enhance efficiency. Bluefin condenser with anti-corrosion treatment ensures durability in salty and rust-prone environments.
- 7 | Oil separator.** A centrifugal separator has been adopted to improve oil separation efficiency and reduce refrigerant pressure loss.

### Maximum comfort with quiet operation mode

- Quiet operation mode reduces outdoor unit operating sound by 7 dB(A)
- 4-step set point is available
- Silent mode 1 maintains rated cooling capacity

\* Timer setting of quiet operation mode is available in high-spec remote controller.

Silent mode options	Sound pressure level
Silent mode 1	-1,5 dB(A)
Silent mode 2	-3 dB(A)
Silent mode 3	-5 dB(A)
Silent mode 4	-7 dB(A)

## Mini ECOi LE2 Series high efficiency 4 to 6 HP · R410A

### Panasonic Mini ECOi. Extraordinary energy-saving.

The most compact ECOi system ever.

- Outstanding SEER and SCOP
- Better efficiency even compared to 2 fan outdoor units



HP			4 HP	5 HP	6 HP	4 HP	5 HP	6 HP
Outdoor unit			U-4LE2E5	U-5LE2E5	U-6LE2E5	U-4LE2E8	U-5LE2E8	U-6LE2E8
Power supply	Voltage	V	220 - 230 - 240	220 - 230 - 240	220 - 230 - 240	380 - 400 - 415	380 - 400 - 415	380 - 400 - 415
	Phase		Single phase	Single phase	Single phase	Three phase	Three phase	Three phase
	Frequency	Hz	50	50	50	50	50	50
Cooling capacity		kW	12,1	14,0	15,5	12,1	14,0	15,5
EER <sup>1)</sup>		W/W	4,50	4,06	3,73	4,50	4,06	3,73
Current		A	13,30 - 12,70 - 12,20	16,30 - 15,60 - 17,00	20,30 - 19,40 - 18,60	4,39 - 4,17 - 4,02	5,58 - 5,30 - 5,11	6,71 - 6,37 - 6,14
Input power		kW	2,69	3,45	4,15	2,69	3,45	4,15
Heating capacity		kW	12,5	16,0	16,5	12,5	16,0	16,5
COP <sup>1)</sup>		W/W	5,19	4,60	4,27	5,19	4,60	4,27
Current		A	12,20 - 11,60 - 11,20	17,60 - 16,80 - 16,10	19,10 - 18,20 - 17,50	3,98 - 3,78 - 3,64	5,62 - 5,34 - 5,14	6,24 - 5,93 - 5,71
Input power		kW	2,41	3,48	3,86	2,41	3,48	3,86
Starting current		A	1,00	1,00	1,00	1,00	1,00	1,00
Maximum current		A	17,30	24,30	27,40	7,90	10,10	10,70
Maximum input power		kW	3,50 - 3,66 - 3,82	4,92 - 5,14 - 5,37	5,61 - 5,86 - 6,12	4,34 - 5,09 - 5,28	6,25 - 6,55 - 6,82	6,62 - 6,97 - 7,23
Maximum number of connectable indoor units <sup>2)</sup>			7(10)	8(10)	9(12)	7(10)	8(10)	9(12)
External static pressure		Pa	0 - 35	0 - 35	0 - 35	0 - 35	0 - 35	0 - 35
Air flow		m <sup>3</sup> /min	69	72	74	69	72	74
Sound pressure	Cool	dB(A)	52	53	54	52	53	53
	Cool (Silent 1/2/3/4)	dB(A)	50,5/49/47/45	51,5/50/48/46	52,5/51/48/46	50,5/49/49/47	48,5/50/48/46	48,5/50/48/46
	Heat	dB(A)	54	56	56	54	56	56
Sound power	Cool / Heat	dB(A)	69/72	71/75	73/75	69/72	71/75	73/75
Dimension	HxWxD	mm	996 x 980 x 370	996 x 980 x 370	996 x 980 x 370	996 x 980 x 370	996 x 980 x 370	996 x 980 x 370
Net weight		kg	106	106	106	106	106	106
Piping diameter	Liquid	Inch (mm)	3/8(9,52)	3/8(9,52)	3/8(9,52)	3/8(9,52)	3/8(9,52)	3/8(9,52)
	Gas	Inch (mm)	5/8(15,88)	5/8(15,88)	5/8(15,88)	5/8(15,88)	5/8(15,88)	5/8(15,88)
Maximum piping length (total)		m	150(180)	150(180)	150(180)	150(180)	150(180)	150(180)
Elevation difference (in / out)		m	50(OU above)/ 40(OU below)	50(OU above)/ 40(OU below)	50(OU above)/ 40(OU below)	50(OU above)/ 40(OU below)	50(OU above)/ 40(OU below)	50(OU above)/ 40(OU below)
Refrigerant (R410A) / CO <sub>2</sub> Eq.		kg / T	6,70(14,40)/ 13,9896	6,70(14,40)/ 13,9896	6,70(14,40)/ 13,9896	6,70(14,40)/ 13,9896	6,70(14,40)/ 13,9896	6,70(14,40)/ 13,9896
Maximum allowable indoor / outdoor capacity ratio		%	50 - 130	50 - 130	50 - 130	50 - 130	50 - 130	50 - 130
Operating range	Cool Min - Max	°C	-10 - +46	-10 - +46	-10 - +46	-10 - +46	-10 - +46	-10 - +46
	Heat Min - Max	°C	-20 - +18	-20 - +18	-20 - +18	-20 - +18	-20 - +18	-20 - +18

ErP data <sup>3)</sup>							
SEER <sup>4)</sup>		<b>7,85</b>	<b>7,48</b>	<b>7,25</b>	<b>7,85</b>	<b>7,48</b>	<b>7,25</b>
$\eta_{s,c}$		<b>311,0%</b>	<b>296,2%</b>	<b>286,8%</b>	<b>311,0%</b>	<b>296,2%</b>	<b>286,8%</b>
SCOP <sup>4)</sup>		<b>4,87</b>	<b>4,40</b>	<b>4,24</b>	<b>4,87</b>	<b>4,40</b>	<b>4,24</b>
$\eta_{s,h}$		<b>191,8%</b>	<b>172,9%</b>	<b>166,7%</b>	<b>191,8%</b>	<b>172,9%</b>	<b>166,7%</b>

1) EER and COP calculation is based in accordance to EN 14511. 2) In case of 1,5 kW indoor units connection, able to connect maximum 12 indoor units. 3) SEER / SCOP and  $\eta_{s,c}$  /  $\eta_{s,h}$  are in accordance with ErP test data for F2 type variable static pressure hide-away indoor units. 4) SEER / SCOP is calculated based on the seasonal space cooling / heating efficiency "η" values of the COMMISSION REGULATION (EU) 2016/2281. SEER, SCOP = (η + Correction) × PEF.

### For light commercial use

Mini ECOi allows easier installation in condominiums and medium sized buildings with limited spaces. Utilising R410A and DC Inverter technology, Panasonic offers VRV to a new and growing market.

### Technical focus

- 50 m piping without additional refrigeration charge
- High static pressure 35 Pa
- High COP mode selectable with maintenance remote controller
- Selectable silent mode

### Reduced height of 996 mm

In addition to raising efficiency, the outdoor unit has been designed to be as compact as possible. It can now be installed in places that were previously too small.



INTERNET CONTROL: Optional.

## Mini ECOi LE1 Series high efficiency 8 and 10 HP · R410A

### Prepare to be blown away by Panasonic's Mini VRF system.

The Mini VRF compact system is the ideal solution for minimum outdoor space.

Panasonic extends the Mini VRF range by 8 and 10 HP units.

- Piping flexibility with 150 m maximum length
- High efficiency



HP			8 HP	10 HP
Outdoor unit			U-8LE1E8	U-10LE1E8
Power supply	Voltage	V	380 - 400 - 415	380 - 400 - 415
	Phase		Three phase	Three phase
	Frequency	Hz	50	50
Cooling capacity		kW	22,4	28,0
EER <sup>1)</sup>		W/W	3,80	3,11
Current		A	9,60 - 9,15 - 8,80	14,70 - 14,00 - 13,50
Input power		kW	5,89	9,00
Heating capacity		kW	25,0	28,0
COP <sup>1)</sup>		W/W	4,02	3,93
Current		A	10,20 - 9,65 - 9,30	11,60 - 11,10 - 10,70
Input power		kW	6,22	7,13
Starting current		A	1,00	1,00
Maximum current		A	13,70	19,60
Maximum input power		kW	9,16	13,10
Maximum number of connectable indoor units <sup>2)</sup>			15	15
External static pressure		Pa	0 - 35	0 - 35
Air flow		m <sup>3</sup> /min	150	160
Sound pressure	Cool	dB(A)	60	63
	Cool (Silent 1/2/3)	dB(A)	57/55/53	60/58/56
	Heat	dB(A)	64	65
Sound power	Cool / Heat	dB(A)	81/85	84/86
Dimension	H x W x D	mm	1500 x 980 x 370	1500 x 980 x 370
Net weight		kg	132	133
Piping diameter	Liquid	Inch (mm)	3/8(9,52) <sup>3)</sup> / 1/2(12,70) <sup>4)</sup>	3/8(9,52) <sup>3)</sup> / 1/2(12,70) <sup>4)</sup>
	Gas	Inch (mm)	3/4(19,05) <sup>3)</sup> / 7/8(22,22) <sup>4)</sup>	7/8(22,22) <sup>3)</sup> / 1(25,40) <sup>4)</sup>
Maximum piping length (total)		m	7,5 - 150 (7,5 - 300)	7,5 - 150 (7,5 - 300)
Elevation difference (in / out)		m	50 (OU above) / 40 (OU below)	50 (OU above) / 40 (OU below)
Refrigerant (R410A) / CO <sub>2</sub> Eq.		kg / T	6,30 (24,00) / 13,1544	6,60 (24,00) / 13,7808
Maximum allowable indoor / outdoor capacity ratio		%	50 - 130	50 - 130
Operating range	Cool Min ~ Max	°C	-10 ~ +46	-10 ~ +46
	Heat Min ~ Max	°C	-20 ~ +18	-20 ~ +18

#### ErP data <sup>5)</sup>

SEER <sup>6)</sup>	<b>6,27</b>	<b>6,37</b>
$\eta_{s,c}$	<b>247,9%</b>	<b>251,8%</b>
SCOP <sup>6)</sup>	<b>4,24</b>	<b>4,31</b>
$\eta_{s,h}$	<b>166,4%</b>	<b>169,5%</b>

1) EER and COP calculation is based in accordance to EN 14511. 2) If the heating utilized, it is necessary to increase 1 size with respect to the main liquid pipe, depending on the combination of the indoor unit. 3) Under 90 m for ultimate indoor unit. 4) Over 90 m for ultimate indoor unit. If the longest piping equivalent length exceeds 90 m, increase the sizes of the main tubes by 1 rank for gas and liquid pipes. 5) SEER / SCOP and  $\eta_{s,c}$  /  $\eta_{s,h}$  are in accordance with ErP test data for F2 type variable static pressure hide-away indoor units. 6) SEER / SCOP is calculated based on the seasonal space cooling / heating efficiency "η" values of the COMMISSION REGULATION (EU) 2016/2281. SEER, SCOP = (η + Correction) × PEF.

### Increase external static pressure

When unit is installed on a narrow balcony, any barrier in front will be an obstacle. High external static pressure will overcome this obstacle and maintain operating capacity.

### Technical focus

- Connection of up to 15 indoor units
- Quiet operation mode (one of the lowest in the market)
- High ambient temp performance
- High static pressure 35 Pa

### High ambient temperature performance

Cooling operation range up to 46 °C. The system can maintain the rated (100%) capacity up to 40 °C by 8 HP model and up to 37 °C by 10 HP model.



INTERNET CONTROL: Optional.



## ECOi EX Series

ECOi EX range system delivering energy-saving performance, powerful operation, reliability and comfort surpassing anything previously possible. Taking quality to the extreme — that's the Panasonic challenge.

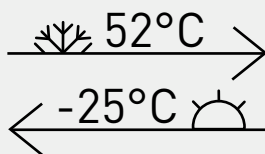

### High performance at extreme conditions.

ECOi EX is highly reliable, with strong cooling and heating power, even when operating at extreme ambient temperatures. The units deliver excellent cooling performance up to 52 °C and heating operation down to -25 °C\*.

Also, the ECOi EX features include Bluefin in the heat exchanger, improving efficiency in marine ambient. A silicone coated PCB (Printed Circuit Board) protects the unit from being damaged by environmental factors such as moisture and dust.



### Outstanding efficiency and comfort.

The ECOi EX system is designed to increase energy efficiency by delivering high SEER rating, as well as high efficiency for part-load operation. The system has reduced energy costs thanks to "All-Inverter Compressors" with independent control, to deliver highly flexible performance. Also, the ECOi EX features an enlarged heat exchanger with triple surfaces that allow for improved heat transfer and a curved air discharge bell-mouth, for better aerodynamics. The three-stage oil recovery design makes it able to minimise the frequency of forced oil recovery, leading to reduced energy costs and sustained comfort.

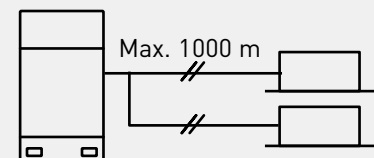

### Superior flexibility.

With up to 1000\* meters of pipeline, 30 meters maximum height difference between indoor units and maximum 100 meters between outdoor unit and indoor unit, the design possibilities have grown exponentially, making the ECOi EX the ideal air conditioning option for expansive buildings, such as train stations, airports, schools or hospitals. These advantages are enhanced with the wide range of indoor unit models and capacities, facilitating the perfect adaptation to all kinds of project. The careful selection of controls and peripherals such as the Pump Down, the AHU and / or the chiller, enables an optimised system selection. Maximum allowable indoor / outdoor connected capacity ratio of up to 200%.

\* Conditions of 2-Pipe ECOi EX ME2 and MZ1 Series.

### Trusted reliability even under high and low temperature conditions.

Designed to be durable enough to withstand extreme heat, 2-Pipe ECOi EX Series ensures reliable cooling operation over an extended operating range up to 52 °C, and heating operation also at -25 °C.

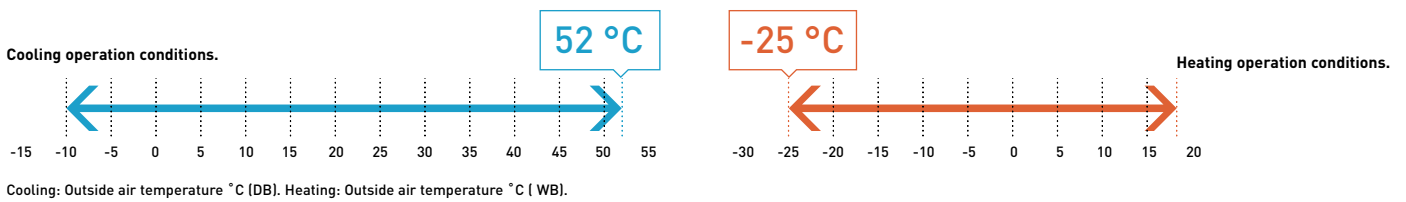

### Maximum allowable connected indoor / outdoor capacity ratio up to 200%\*

ECOi EX attain maximum indoor unit connection capacity of up to 130% of the unit's connection range. This limit can be surpassed and reach up to 200% if some conditions are satisfied. With this feature, ECOi EX provides an ideal air conditioning solution for locations where full cooling / heating are not always required in all spaces at same time.

System (HP)	8	10	12	14	16	18	20	22	24	26	28	30	32	34	36	38	40	42	44	46	48	50	52	54	56	58	60	62	64	66	68	70	72	74	76	78	80			
Connectable indoor units: 130%	13	16	19	23	26	29	33	36	40	43	46	50	53	56	59															64										
Connectable indoor units: 200%	20	25	30	35	40	45	50	55	60											64																				

Note: If more than 100% indoor units are operated with a high load, the units may not perform at the rated capacity. For the details, please consult with an authorised Panasonic dealer. \* If the following conditions are satisfied, the effective range is above 130% up to 200%. Obey the limited number of connectable indoor units. The lower limit of operating range for heating outdoor temperature is limited to -10 °C WB (standard -25 °C WB). Simultaneous operation is limited to less than 130% of connectable indoor units. 1.5 kW capacity of Indoor Units are included. System range availability depends on the series.

### Increased piping lengths and design flexibility

Adaptable to various building types and sizes. Actual piping length: 200 m. Maximum piping length: 1000 m.

- 1) 40 m if the outdoor unit is below the indoor unit.
- 2) For height differences between outdoor unit and indoor unit > 50 m, as well as for height differences between indoor units > 15 m, contact an authorized Panasonic dealer.

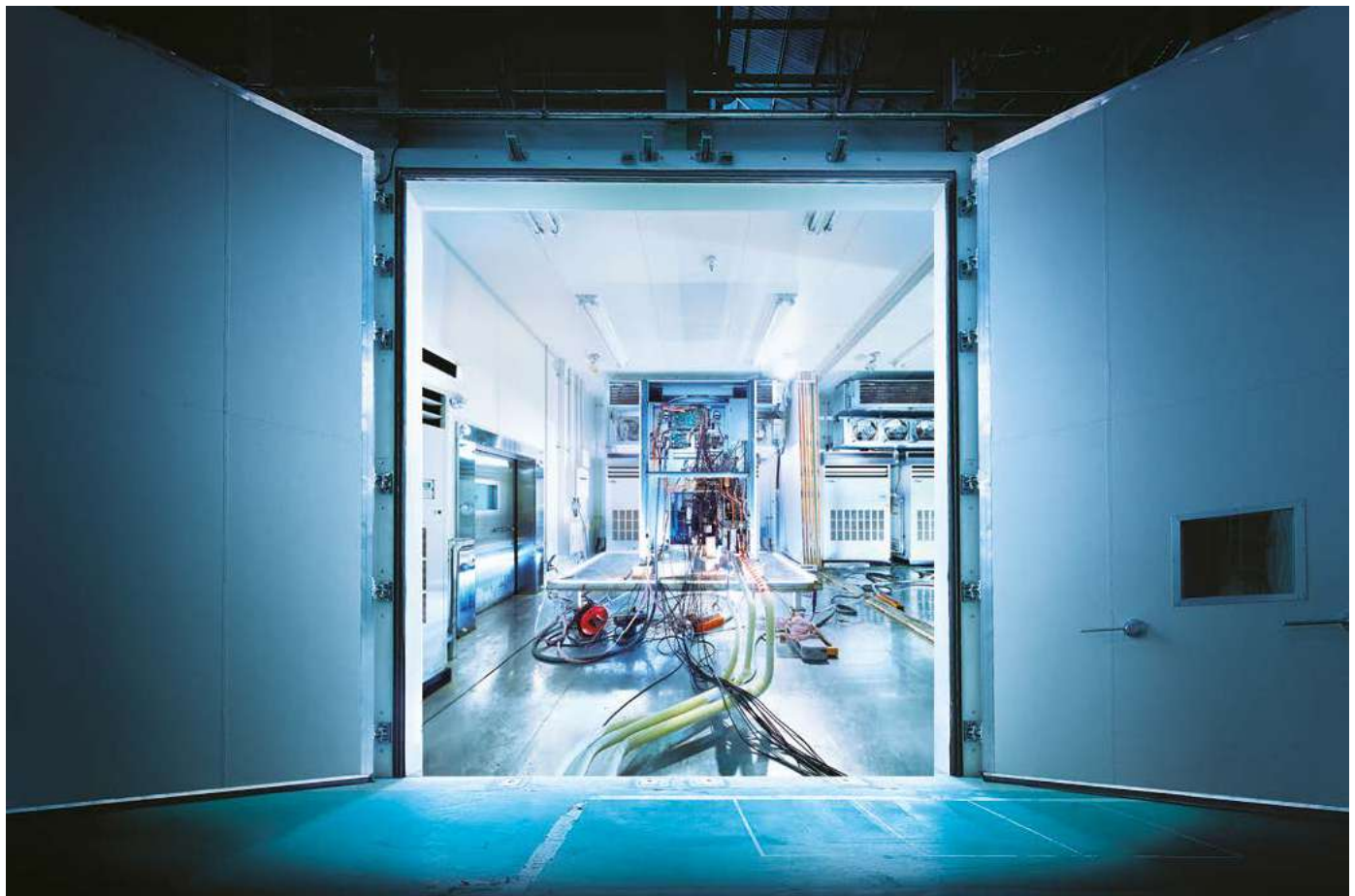
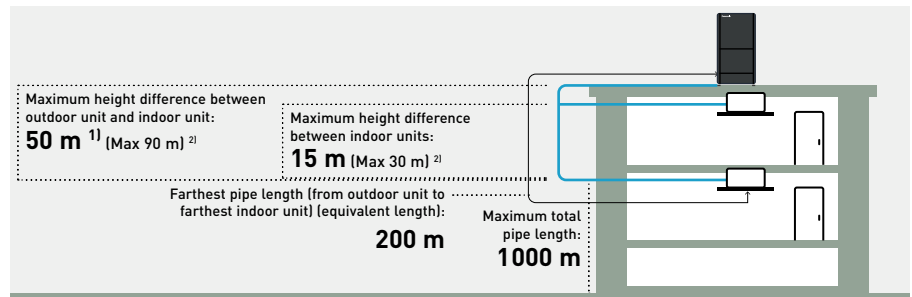

# Superior quality, reliability and durability

High-quality components are selected to deliver exceptional energy savings and ensure long-lasting performance.

Invest in quality. Prioritise safety. Choose ECOi EX Series.

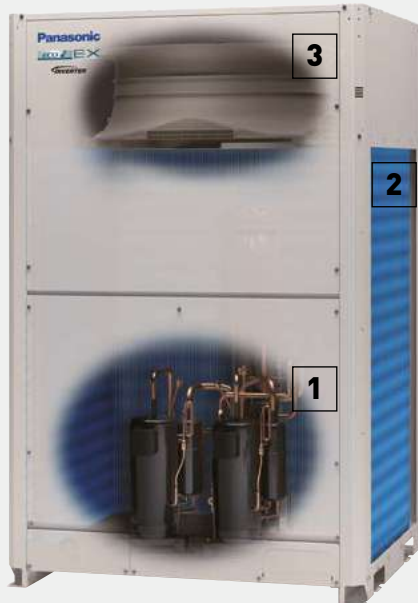

R410A ME2/MF3 Series



R32 MZ1 Series

1

## High-efficiency refrigerant circuit.

### Panasonic Inverter-driven compressor.

Inverter-driven compressor equipped, to optimise high-efficiency operation year-round.

- MZ1 Series: Inverter-driven scroll compressor
- ME2/MF3 Series: Inverter-driven rotary compressor

### Accumulator.

Oil returning circuit with control valve makes efficient oil recovery to compressors.

### Oil separator.

Modified tank design makes efficient oil separation with less pressure drop.



### Receiver tank-less design.

Improved refrigerant control program recovers the remaining refrigerant gas in the system back to the accumulator tank effectively.

2

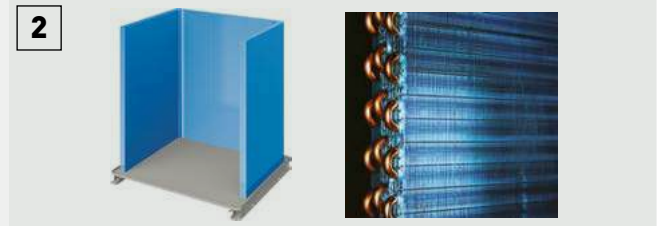

### Enlarged heat exchanger surface area with triple rows.

The unit has become more compact while maintaining high equivalent efficiency, thanks to the enlarged heat exchanger surface area with triple rows\*.

\* Subject to model specifications.

### Anti-corrosion Bluefin treatment.

High corrosion resistance to rust and salty air for lasting performance.

3

### Smooth exhaust flow by bell-mouth.

Specially designed curved air discharge bell-mouth for better aerodynamics.

4

### Grey panel colour.

The grey panel colour of the outdoor unit allows it to blend in and be installed discreetly on a wide variety of installations.

5

### 7-segment display.

7-segment display for ease of user installation, commissioning, service and maintenance.



# Oil recovery intelligent control

Oil recovery intelligent control advantages: higher efficiency, durability and comfort (continuous operation, low noise and low vibration).

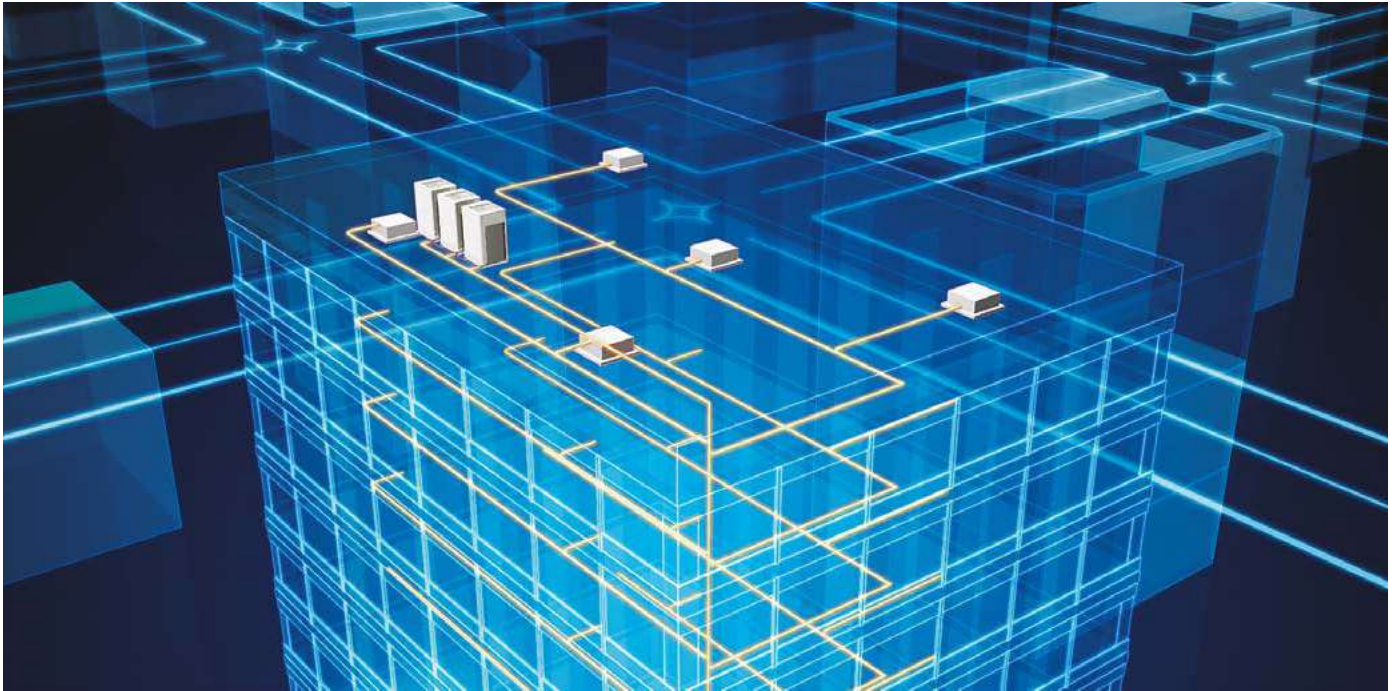

## Intelligent 3-stage oil management system

In a VRF system, where lengthy piping and a large number of indoor units need to be controlled collectively, the key to maintaining the system's reliability is to ensure an appropriate amount of oil is secured in the compressors. In order to avoid oil shortage in the compressor, maximum operation is normally forcibly conducted at regular intervals to recover oil from indoor units. This method, typically employed in a standard VRF, causes the system to overheat or overcool and thus waste energy. In Panasonic VRF systems, a sensor for detecting oil levels is mounted in each compressor. In installations with multiple outdoor units, a shortage of oil in one compressor can be compensated for by recovering oil either from another compressor in the same unit, from a compressor in an adjacent outdoor unit, or from connected indoor units. Panasonic VRF systems provide users with a comfortable environment whilst saving energy.

**The Panasonic system efficiently manages oil recovery in three stages; minimising the frequency of forced oil recovery while reducing energy cost and maintaining comfort.**

**STAGE-1:** Panasonic compressors are equipped with sensors which monitor oil levels precisely at all times. If oil levels fall, oil can be transferred from other compressors within the same outdoor unit\*.

**STAGE-2:** If oil levels in all compressors within the outdoor unit fall, oil can be replenished from adjacent outdoor units.

**STAGE-3:** Forced oil recovery is implemented only if oil levels become insufficient in spite of above measures. The Panasonic system's design concept is radically different from conventional oil systems.

\* Applicable to ECOi EX outdoor units over 14 HP (2-compressor models).

## Features of oil recovery design

### Oil sensors installed in each compressor\*.

Oil sensors installed in each Panasonic compressor precisely monitor oil levels, eliminating unnecessary oil recovery.

\* Applicable to ECOi EX outdoor units over 14 HP (2-compressor models).

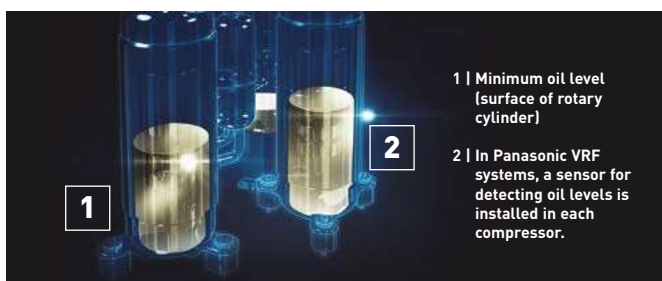

### Highly functional oil separator.

Thanks to extended separate piping, oil recovery efficiency reaches 90%, minimising the oil discharged from the compressor.

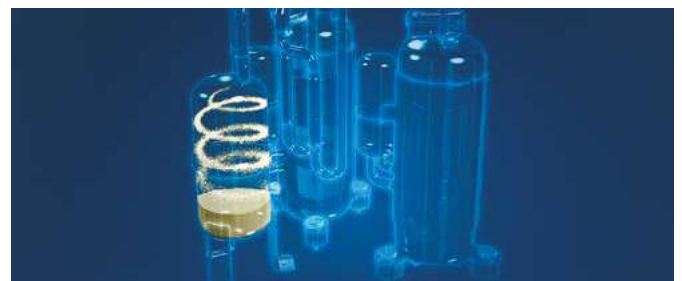

# New generation of 2-Pipe ECOi EX MZ1 Series R32

Extreme efficiency, quality, compact.

Panasonic provides safety measure compliant with the latest standards, as required based on R32 refrigerant density under specific project conditions. Everything necessary for R32 refrigerant safety is prepared by Panasonic.



**Reliable quality - R32 standard-compliant <sup>1)</sup>.**

$\eta_{s,c}$   $\eta_{s,h}$   
310,1% <sup>2)</sup> 172,4% <sup>2)</sup>

**High seasonal efficiency.**



**More sustainable solution <sup>3)</sup>.**



**Saving installation space.**

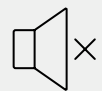

**Silent mode, maintaining high capacity.**

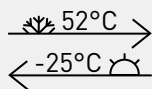

**Extended operation range.**

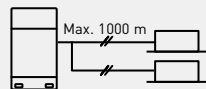

**Flexible piping installation.**



**Maximum indoor / outdoor capacity ratio 200%.**



**Saving installation cost.**

<sup>1)</sup> Panasonic's R32 safety measures comply with IEC 60335-2-40 (ed. 7.0) and EN 378 (ISO 5149). <sup>2)</sup> U-10M21E8. <sup>3)</sup> Compared to R410A systems.

## 2-Pipe ECOi EX MZ1 Series R32. Enjoy greater installation flexibility and cost savings.



### Extensive R32 range to meet any project requirements

- All air to air indoor units are equipped with nanoe™ X for improved indoor air quality
- A range of ventilations including ERVs and AHU connection kits
- A wide range of connectivity options, including stand-alone, central, and remote monitoring, with BMS integration for seamless operation



### High efficiency in a compact outdoor unit

Significantly reduced volume and a lightweight chassis help reduce design and installation work.

#### MZ1 Series seasonal efficiency.

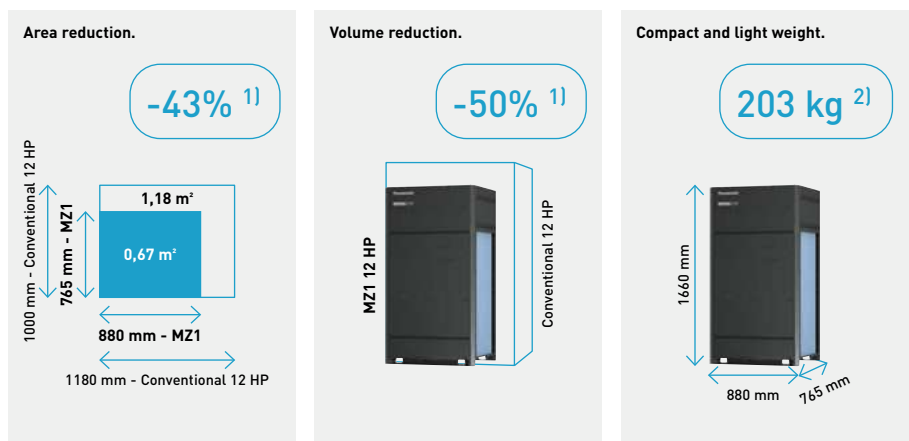
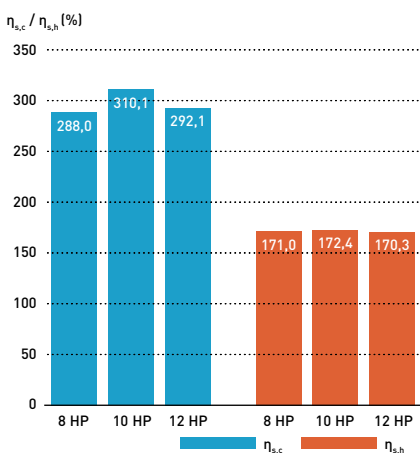

1) 12 HP model compared to the equivalent conventional R410A ECOi EX model. 2) 8 and 10 HP models.

### Maximum comfort with silent operation mode

Thanks to the optimised bell mouth design, sound pressure can be reduced to as low as 54 dB(A)\* in silent mode while maintaining high cooling capacity.

\* For model U-8MZ1E8.

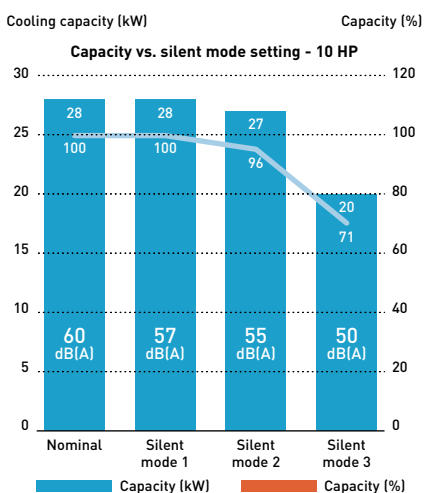

- Silent operation mode reduces outdoor unit noise down to 50 dB(A)
- 3-step set point available
- Silent mode 1 maintains rated 100% cooling capacity

Noise (SPL)	8 HP	10 HP	12 HP
Nominal	57 dB(A)	60 dB(A)	64 dB(A)
Silent mode 1	54 dB(A)	57 dB(A)	61 dB(A)
Silent mode 2	52 dB(A)	55 dB(A)	59 dB(A)
Silent mode 3	50 dB(A)	50 dB(A)	50 dB(A)

#### Improved bell mouth design.

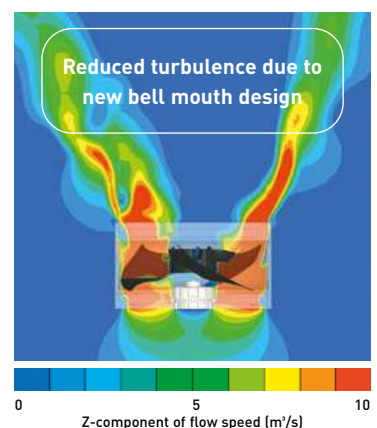

# MZ1 Series maintains high performance even at extremely low winter temperatures.

## Wide operating limits

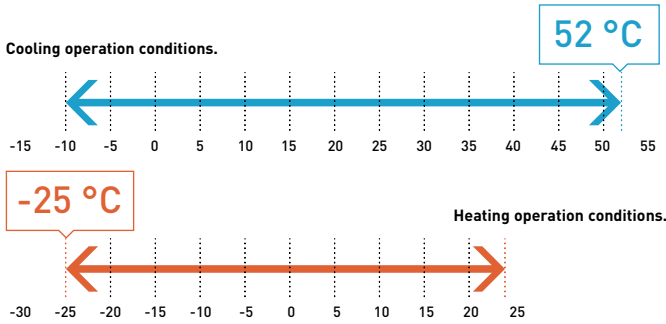

Cooling: Outside air temperature °C (DB). Heating: Outside air temperature °C (WB).

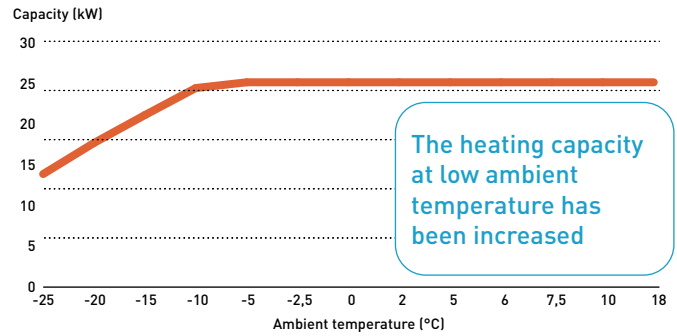

\* Maximum capacity unaffected by defrost operation.

## Refrigerant amount reduction and piping material choice

The new MZ1 Series uses only 57%\* of the R32 refrigerant compared to the R410A equivalent system and supports imperial or metric piping installation.

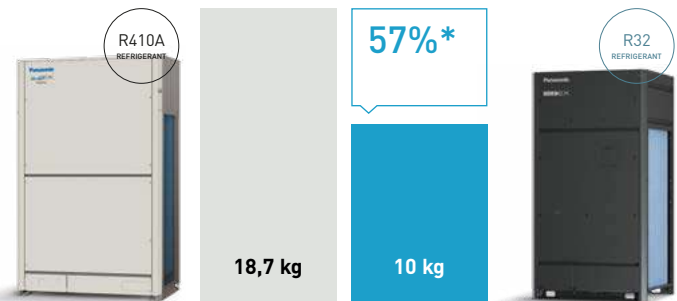

\* Panasonic's internal research. 12 HP model with 30 m piping installation.

## R32 safety measures by Panasonic.

### Everything necessary for R32 refrigerant safety is prepared by Panasonic.

Panasonic provides safety measure compliant with the latest standards, as required based on R32 refrigerant density under specific project conditions. Everything necessary for R32 refrigerant safety is prepared by Panasonic.

The safety measures which comply with EN 378 (ISO 5149) and IEC 60335-2-40 (ed. 7.0).

#### Leak detector - CZ-CGLSC2.

Leak detector designed for 4 way 90x90 cassettes, 4 way 60x60 cassettes, and wall-mounted units.



#### Leak alarm - CZ-CGLALC1.

R32 refrigerant leak alarm designed for adaptive duct and slim duct units.



#### 2-pipe safety valve kit - CZ-P1160SVK.

A 2-pipe safety valve manages the shutdown of only the area / zone experiencing a refrigerant leak, instead of shutting down the whole system.



#### External power supply - PAW-16DC-ALC1.

External 16 V power supply (EN 378 compliant), including a leak alarm for remote locations. The leak alarm can be deactivated.



### Example of how R32 safety measures work in an HVAC system.

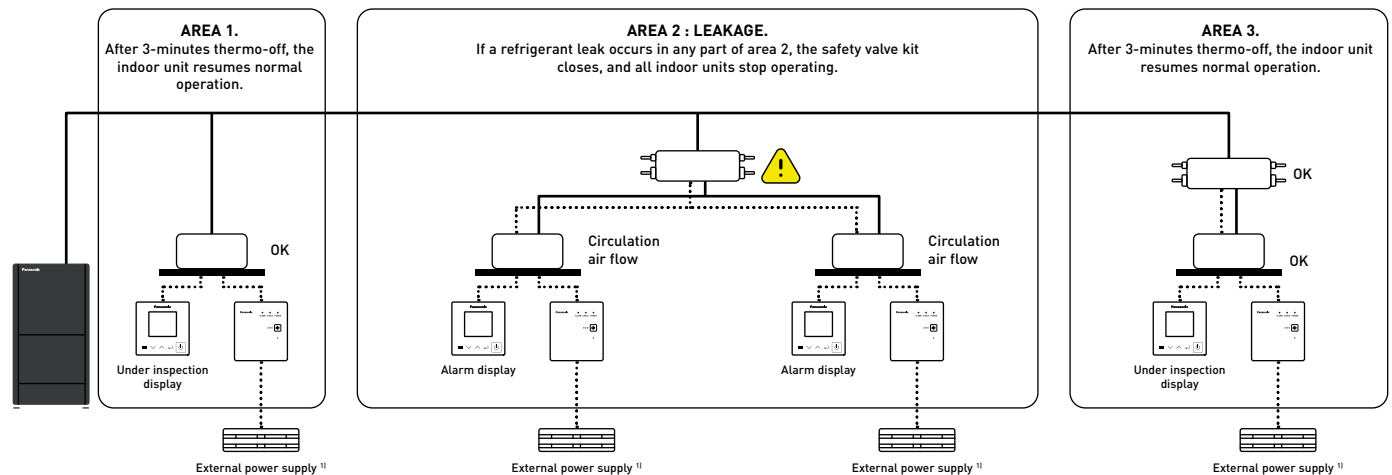

\* A maximum of 1 leak detector can be connected per indoor unit or group. If a leak detector is connected, only 1 wired remote controller is allowed (no sub-controller). Up to 8 units, including indoor units and a safety valve, can be connected. 1) In accordance with EN 378-3, alarm systems such as external leak detectors and safety alarms require a power source independent of the air conditioning system they are protecting. In addition, they must have a backup power source and be able to alert a monitored location. For further information, please contact an authorised Panasonic dealer.

## NEW 2-Pipe ECOi EX MZ1 Series - R32

## Extreme efficiency, quality, compact.

With advanced R32 refrigerant technology and optimised system design, this series offers a more sustainable solution compared to R410A.

Wide operation range from -25 °C in heating to +52 °C in cooling.

New 2025



HP			8 HP	10 HP	12 HP
Outdoor unit			U-8MZ1E8	U-10MZ1E8	U-12MZ1E8
Power supply	Voltage	V	380 - 400 - 415	380 - 400 - 415	380 - 400 - 415
	Phase		Three phase	Three phase	Three phase
	Frequency	Hz	50	50	50
Cooling capacity		kW	22,4	28,0	33,5
EER <sup>1)</sup>		W/W	3,30	3,50	3,00
Current		A	11,70 - 11,10 - 10,70	13,50 - 12,80 - 12,40	18,30 - 17,40 - 16,80
Input power		kW	6,78	8,00	11,1
Heating capacity		kW	25,0	31,5	37,5
COP <sup>1)</sup>		W/W	4,50	4,30	4,00
Current		A	9,81 - 9,32 - 8,98	12,50 - 11,90 - 11,50	15,70 - 14,90 - 14,40
Input power		kW	5,55	7,32	9,37
Starting current		A	1,00	1,00	1,00
External static pressure (Max)		Pa	80	80	80
Air flow		m <sup>3</sup> /min	209	209	209
Sound pressure	Normal mode (Cool / Heat)	dB(A)	57/57	60/60	64/67
	Silent mode 1 / 2 / 3 (Cool)	dB(A)	54/52/50	57/55/50	61/59/50
Sound power	Normal mode (Cool / Heat)	dB(A)	75/75	77/77	81/84
Dimension	HxWxD	mm	1660x880x765	1660x880x765	1660x880x765
Net weight		kg	203	203	206
	Liquid	Inch (mm)	3/8(9,52)/1/2(12,70)	3/8(9,52)/1/2(12,70)	3/8(9,52)/1/2(12,70)
	Gas	Inch (mm)	3/4(19,05)/7/8(22,22)	3/4(19,05)/7/8(22,22)	7/8(22,22)/1-1/8(28,58)
Piping diameter <sup>2)</sup>	Balance	Inch (mm)	1/4(6,35)	1/4(6,35)	1/4(6,35)
Refrigerant (R32) / CO <sub>2</sub> Eq		kg/T	6,30/4,25	6,40/4,32	8,50/5,74
Maximum allowable indoor / outdoor capacity ratio <sup>3)</sup>		%	50 ~ 200(130)	50 ~ 200(130)	50 ~ 200(130)
Operating range	Cool Min ~ Max	°C	-10 ~ +52	-10 ~ +52	-10 ~ +52
	Heat Min ~ Max	°C	-25 ~ +24	-25 ~ +24	-25 ~ +24

ErP data <sup>4)</sup>					
SEER <sup>5)</sup>			7,27	7,82	7,37
$\eta_{s,c}$			288,0%	310,1%	292,1%
SCOP <sup>5)</sup>			4,35	4,38	4,33
$\eta_{s,h}$			171,0%	172,4%	170,3%

1) EER and COP calculation is based in accordance to EN 14511. 2) Piping diameter under 100 m for ultimate indoor unit / over 100 m for ultimate indoor unit (if the longest piping equivalent length exceeds 100 m, increase the sizes of the main tubes by 1 rank for gas tubes and liquid tubes). 3) If the following conditions are satisfied, the effective range is above 130% and below 200%: A. Obey the limited number of connectable indoor units. B. The lower limit of operating range for heating outdoor temperature is limited to -10 °C WB (standard -25 °C WB). C. Simultaneous operation is limited to less than 130% of connectable indoor units. 4) SEER / SCOP and  $\eta_{s,c}$  /  $\eta_{s,h}$  are in accordance with ErP test data for U2 type 4 way 90x90 cassette indoor units. 5) SEER / SCOP is calculated based on the seasonal space cooling / heating efficiency "η" values of the COMMISSION REGULATION (EU) 2016/2281. SEER, SCOP = (η + Correction) × PEF.

## Technical focus

- Compact outdoor unit with a significant 43% <sup>1)</sup> footprint reduction, delivering high seasonal efficiency, reliable quality, and R32 standard compliance
- The series uses only 57% <sup>2)</sup> of the R32 refrigerant compared to R410A equivalent system, minimizing the need for extra safety measures
- Extensive R32 Range with all air-to-air indoor units equipped with nanoe™ X, along with ERVs and AHU connection kits

- A wide range of connectivity options, including stand-alone, central, and remote monitoring, with BMS integration for seamless operation

1) 12 HP model compared to the equivalent conventional R410A ECOi EX ME2.  
2) Panasonic's internal research. 12 HP model with 30 m piping installation.



## 2-Pipe ECOi EX MZ1 Series R32 combination from 16 to 48 HP · R32

HP		16 HP	18 HP	20 HP	20 HP	22 HP	24 HP	24 HP	26 HP
Outdoor unit		U-8MZ1E8	U-8MZ1E8	U-8MZ1E8	U-10MZ1E8	U-10MZ1E8	U-12MZ1E8	U-8MZ1E8	U-8MZ1E8
		U-8MZ1E8	U-10MZ1E8	U-12MZ1E8	U-10MZ1E8	U-12MZ1E8	U-12MZ1E8	U-8MZ1E8	U-8MZ1E8
Power supply	Voltage	V 380-400-415							
	Phase	Three phase							
	Frequency	Hz 50							
Cooling capacity	kW	44,8	50,4	55,9	56,0	61,5	67,0	67,2	72,8
EER <sup>1)</sup>	W/W	3,20	3,40	3,10	3,50	3,20	3,00	3,20	3,30
SEER <sup>2)</sup> / η <sub>sc</sub>		<b>7,24/286,8%</b>	<b>7,56/299,6%</b>	<b>7,29/288,9%</b>	<b>7,82/310,1%</b>	<b>7,55/299,1%</b>	<b>7,33/290,2%</b>	<b>7,24/286,8%</b>	<b>7,46/295,6%</b>
Current	A	23,40-22,20-21,40	25,20-23,90-23,10	30,00-28,50-27,50	27,00-25,60-24,80	31,80-30,20-29,20	36,60-34,80-33,60	35,10-33,30-32,10	36,90-35,00-33,80
Input power	kW	13,6	14,8	17,9	16,0	19,1	22,2	20,4	21,6
Heating capacity	kW	50,0	56,5	62,5	63,0	69,0	75,0	75,0	81,5
COP <sup>1)</sup>	W/W	4,50	4,30	4,10	4,20	4,10	3,90	4,40	4,40
SCOP <sup>2)</sup> / η <sub>sh</sub>		<b>4,32/169,8%</b>	<b>4,33/170,3%</b>	<b>4,29/168,8%</b>	<b>4,38/172,2%</b>	<b>4,34/170,7%</b>	<b>4,33/170,2%</b>	<b>4,32/169,8%</b>	<b>4,31/169,5%</b>
Current	A	19,62-18,64-17,96	22,31-21,22-20,48	25,51-24,22-23,38	25,00-23,80-23,00	28,20-26,80-25,50	31,40-29,80-28,80	29,43-27,96-26,94	32,12-30,54-29,46
Input power	kW	11,1	12,9	15,0	14,7	16,7	18,8	16,7	18,5
Starting current	A	1,00	1,00	1,00	1,00	1,00	1,00	1,00	1,00
External static pressure (Max)	Pa	80	80	80	80	80	80	80	80
Air flow	m <sup>3</sup> /min	418	418	418	418	418	418	627	627
Sound pressure	Normal mode (Cool / Heat)	dB(A) 60,0/60,0							
	Silent mode 1 / 2 (Cool)	dB(A) 57,0/55,0							
Sound power	Normal mode (Cool / Heat)	dB(A) 78,0/78,0							
		dB(A) 79,5/79,5							
Dimension	H x W x D	mm 1660 x 1760							
		mm (+60) x 765							
		mm (+60) x 765							
Net weight	kg	406	406	409	406	409	412	609	609
Piping diameter <sup>3)</sup>	Liquid	Inch (mm) 1/2(12,70)/5/8(15,88)							
	Gas	Inch (mm) 1-1/8(28,58)/1-3/8(34,96)							
	Balance	Inch (mm) 1/4(6,35)							
Refrigerant (R32) / CO <sub>2</sub> Eq.	kg / T	12,6/8,51	12,7/8,57	14,8/9,99	12,8/8,64	14,9/10,06	17,0/11,48	18,9/12,76	19,0/12,83
Maximum allowable indoor / outdoor capacity ratio <sup>4)</sup>	%	50 ~ 130(200)							
Operating range	Cool Min ~ Max	°C -10 ~ +52							
	Heat Min ~ Max	°C -25 ~ +24							

HP		28 HP	28 HP	30 HP	30 HP	32 HP	32 HP	32 HP	34 HP
Outdoor unit		U-8MZ1E8	U-8MZ1E8	U-8MZ1E8	U-10MZ1E8	U-8MZ1E8	U-10MZ1E8	U-8MZ1E8	U-10MZ1E8
		U-8MZ1E8	U-10MZ1E8	U-10MZ1E8	U-10MZ1E8	U-12MZ1E8	U-10MZ1E8	U-8MZ1E8	U-12MZ1E8
Power supply	Voltage	V 380-400-415							
	Phase	Three phase							
	Frequency	Hz 50							
Cooling capacity	kW	78,3	78,4	83,9	84,0	89,4	89,5	89,6	95,0
EER <sup>1)</sup>	W/W	3,10	3,40	3,20	3,50	3,00	3,30	3,20	3,10
SEER <sup>2)</sup> / η <sub>sc</sub>		<b>7,23/286,3%</b>	<b>7,61/301,5%</b>	<b>7,45/295,1%</b>	<b>7,82/310,1%</b>	<b>7,26/287,4%</b>	<b>7,63/302,4%</b>	<b>7,24/286,8%</b>	<b>7,37/291,8%</b>
Current	A	41,70-39,60-38,20	38,70-36,70-35,50	43,50-41,30-39,90	40,50-38,40-37,20	48,30-45,90-44,30	45,30-43,00-41,60	46,80-44,40-42,80	50,10-47,60-46,00
Input power	kW	24,7	22,8	25,9	24,0	29,0	27,1	27,2	30,2
Heating capacity	kW	87,5	88,0	94,0	94,5	100,0	100,0	100,0	106,0
COP <sup>1)</sup>	W/W	4,20	4,30	4,20	4,20	4,10	4,10	4,50	4,00
SCOP <sup>2)</sup> / η <sub>sh</sub>		<b>4,34/170,9%</b>	<b>4,35/171,2%</b>	<b>4,33/170,4%</b>	<b>4,38/172,4%</b>	<b>4,31/169,6%</b>	<b>4,38/172,2%</b>	<b>4,32/169,8%</b>	<b>4,29/168,7%</b>
Current	A	35,32-33,54-32,36	34,81-33,12-31,98	38,01-36,12-34,88	37,50-35,70-34,50	41,21-39,12-37,78	40,70-38,70-37,40	39,24-37,28-35,92	43,90-41,70-40,30
Input power	kW	20,5	20,2	22,3	22,0	24,3	24,1	22,2	26,1
Starting current	A	1,00	1,00	1,00	1,00	1,00	1,00	1,00	1,00
External static pressure (Max)	Pa	80	80	80	80	80	80	80	80
Air flow	m <sup>3</sup> /min	627	627	627	627	627	627	836	627
Sound pressure	Normal mode (Cool / Heat)	dB(A) 65,5/68,0							
	Silent mode 1 / 2 (Cool)	dB(A) 62,5/60,5							
Sound power	Normal mode (Cool / Heat)	dB(A) 83,0/85,0							
		dB(A) 81,5/81,5							
Dimension	H x W x D	mm 1660 x 2640							
		mm (+120) x 765							
		mm (+120) x 765							
Net weight	kg	612	609	612	609	615	612	812	615
Piping diameter <sup>3)</sup>	Liquid	Inch (mm) 1/2(12,70)/5/8(15,88)							
	Gas	Inch (mm) 1-1/8(28,58)/1-3/8(34,96)							
	Balance	Inch (mm) 1/4(6,35)							
Refrigerant (R32) / CO <sub>2</sub> Eq.	kg / T	21,1/14,24	19,1/12,89	21,2/14,31	19,2/12,96	23,3/15,73	21,3/14,38	25,2/17,01	23,4/15,80
Maximum allowable indoor / outdoor capacity ratio <sup>4)</sup>	%	50 ~ 130(200)							
Operating range	Cool Min ~ Max	°C -10 ~ +52							
	Heat Min ~ Max	°C -25 ~ +24							

1) EER and COP calculation is based in accordance to EN 14511. 2) SEER / SCOP is calculated based on the seasonal space cooling / heating efficiency "η" values of the COMMISSION REGULATION (EU) 2016/2281. SEER, SCOP = (η + Correction) × PEF. 3) Piping diameter under 100 m for ultimate indoor unit / over 100 m for ultimate indoor unit (if the longest piping equivalent length exceeds 100 m, increase the sizes of the main tubes by 1 rank for gas tubes and liquid tubes). 4) If the following conditions are satisfied, the effective range is above 130% and below 200%: A. Obey the limited number of connectable indoor units. B. The lower limit of operating range for heating outdoor temperature is limited to -10 °C WB [standard -25 °C WB]. C. Simultaneous operation is limited to less than 130% of connectable indoor units.

4) SEER / SCOP and η<sub>sc</sub> / η<sub>sh</sub> are in accordance with ErP test data for U2 type 4 way 90x90 cassette indoor units.

HP			34 HP	36 HP	36 HP	36 HP	38 HP	38 HP	40 HP	40 HP
Outdoor unit			U-8MZ1E8	U-12MZ1E8	U-8MZ1E8	U-8MZ1E8	U-8MZ1E8	U-8MZ1E8	U-8MZ1E8	U-10MZ1E8
			U-8MZ1E8	U-12MZ1E8	U-8MZ1E8	U-8MZ1E8	U-8MZ1E8	U-10MZ1E8	U-8MZ1E8	U-10MZ1E8
			U-8MZ1E8	U-12MZ1E8	U-10MZ1E8	U-8MZ1E8	U-8MZ1E8	U-10MZ1E8	U-10MZ1E8	U-10MZ1E8
			U-10MZ1E8		U-10MZ1E8	U-12MZ1E8	U-12MZ1E8	U-10MZ1E8	U-12MZ1E8	U-10MZ1E8
Power supply	Voltage	V	380-400-415	380-400-415	380-400-415	380-400-415	380-400-415	380-400-415	380-400-415	380-400-415
	Phase		Three phase	Three phase	Three phase	Three phase	Three phase	Three phase	Three phase	Three phase
	Frequency	Hz	50	50	50	50	50	50	50	50
Cooling capacity		kW	95,2	100,0	100,0	100,0	106,0	106,0	111,0	112,0
EER <sup>1)</sup>		W/W	3,30	3,00	3,30	3,10	3,20	3,40	3,10	3,50
<b>SEER<sup>2)</sup> / η<sub>sc</sub></b>			<b>7,37/291,8%</b>	<b>7,37/292,0%</b>	<b>7,53/298,2%</b>	<b>7,25/287,0%</b>	<b>7,36/291,7%</b>	<b>7,66/303,4%</b>	<b>7,30/289,0%</b>	<b>7,82/310,1%</b>
Current		A	48,60-46,10-44,50	54,90-52,20-50,40	50,40-47,80-46,20	53,40-50,70-48,90	55,20-52,40-50,60	52,20-49,50-47,90	60,00-57,00-55,00	54,00-51,20-49,60
Input power		kW	28,4	33,3	29,6	31,5	32,7	30,8	35,8	32,0
Heating capacity		kW	106,0	112,0	113,0	112,0	119,0	119,0	125,0	126,0
COP <sup>1)</sup>		W/W	4,40	3,90	4,30	4,20	4,20	4,30	4,10	4,30
<b>SCOP<sup>2)</sup> / η<sub>sh</sub></b>			<b>4,29/168,7%</b>	<b>4,33/170,3%</b>	<b>4,33/170,3%</b>	<b>4,32/170,1%</b>	<b>4,31/169,6%</b>	<b>4,36/171,4%</b>	<b>4,29/168,8%</b>	<b>4,38/172,2%</b>
Current		A	41,93-39,86-38,44	47,10-44,70-43,20	44,62-42,44-40,96	45,13-42,86-41,34	47,82-45,44-43,86	47,31-45,02-43,48	51,02-48,44-46,76	50,00-47,60-46,00
Input power		kW	24,0	28,2	25,8	26,1	27,8	27,6	29,9	29,3
Starting current		A	1,00	1,00	1,00	1,00	1,00	1,00	1,00	1,00
External static pressure (Max)		Pa	80	80	80	80	80	80	80	80
Air flow		m <sup>3</sup> /min	836	627	836	836	836	836	836	836
Sound pressure	Normal mode (Cool / Heat)	dB(A)	64,0/64,0	69,0/72,0	65,0/65,0	66,0/68,5	66,5/68,5	65,5/65,5	68,0/70,5	66,0/66,0
	Silent mode 1 / 2 (Cool)	dB(A)	61,0/59,0	66,0/64,0	62,0/60,0	63,0/61,0	63,5/61,5	62,5/60,5	65,0/63,0	63,0/61,0
Sound power	Normal mode (Cool / Heat)	dB(A)	82,0/82,0	86,0/89,0	82,5/82,5	83,5/85,5	84,0/86,0	83,0/83,0	85,0/87,5	83,0/83,0
Dimension	H x W x D	mm	1660 x 3520 (+180) x 765	1660 x 2640 (+120) x 765	1660 x 3520 (+180) x 765	1660 x 3520 (+180) x 765	1660 x 3520 (+180) x 765	1660 x 3520 (+180) x 765	1660 x 3520 (+180) x 765	1660 x 3520 (+180) x 765
Net weight		kg	812	618	812	815	815	812	818	812
Piping diameter <sup>3)</sup>	Liquid	Inch (mm)	5/8(15,88)/3/4(19,05)	5/8(15,88)/3/4(19,05)	5/8(15,88)/3/4(19,05)	5/8(15,88)/3/4(19,05)	5/8(15,88)/3/4(19,05)	5/8(15,88)/3/4(19,05)	5/8(15,88)/3/4(19,05)	5/8(15,88)/3/4(19,05)
	Gas	Inch (mm)	1-3/8(34,96)/15/8(15,88)	1-3/8(34,96)/15/8(15,88)	1-3/8(34,96)/15/8(15,88)	1-3/8(34,96)/15/8(15,88)	1-3/8(34,96)/15/8(15,88)	1-3/8(34,96)/15/8(15,88)	1-3/8(34,96)/15/8(15,88)	1-3/8(34,96)/15/8(15,88)
	Balance	Inch (mm)	1/4(6,35)	1/4(6,35)	1/4(6,35)	1/4(6,35)	1/4(6,35)	1/4(6,35)	1/4(6,35)	1/4(6,35)
Refrigerant (R32) / CO <sub>2</sub> Eq.		kg / T	25,3/17,08	25,5/17,21	25,4/17,15	27,4/18,50	27,5/18,56	25,5/17,21	29,6/19,98	25,6/17,28
Maximum allowable indoor / outdoor capacity ratio <sup>4)</sup>		%	50 ~ 130(200)	50 ~ 130(200)	50 ~ 130(200)	50 ~ 130(200)	50 ~ 130(200)	50 ~ 130(200)	50 ~ 130(200)	50 ~ 130(200)
Operating range	Cool Min ~ Max	°C	-10 ~ +52	-10 ~ +52	-10 ~ +52	-10 ~ +52	-10 ~ +52	-10 ~ +52	-10 ~ +52	-10 ~ +52
	Heat Min ~ Max	°C	-25 ~ +24	-25 ~ +24	-25 ~ +24	-25 ~ +24	-25 ~ +24	-25 ~ +24	-25 ~ +24	-25 ~ +24

HP			40 HP	42 HP	42 HP	44 HP	44 HP	46 HP	48 HP
Outdoor unit			U-8MZ1E8	U-8MZ1E8	U-10MZ1E8	U-8MZ1E8	U-10MZ1E8	U-10MZ1E8	U-12MZ1E8
			U-10MZ1E8	U-10MZ1E8	U-10MZ1E8	U-12MZ1E8	U-12MZ1E8	U-12MZ1E8	U-12MZ1E8
			U-10MZ1E8	U-12MZ1E8	U-10MZ1E8	U-12MZ1E8	U-12MZ1E8	U-12MZ1E8	U-12MZ1E8
			U-12MZ1E8	U-12MZ1E8	U-12MZ1E8	U-12MZ1E8	U-12MZ1E8	U-12MZ1E8	U-12MZ1E8
Power supply	Voltage	V	380-400-415	380-400-415	380-400-415	380-400-415	380-400-415	380-400-415	380-400-415
	Phase		Three phase	Three phase	Three phase	Three phase	Three phase	Three phase	Three phase
	Frequency	Hz	50	50	50	50	50	50	50
Cooling capacity		kW	111,0	117,0	117,0	122,0	123,0	128,0	134,0
EER <sup>1)</sup>		W/W	3,20	3,10	3,30	3,00	3,20	3,00	3,00
<b>SEER<sup>2)</sup> / η<sub>sc</sub></b>			<b>7,53/298,2%</b>	<b>7,43/294,4%</b>	<b>7,65/303,2%</b>	<b>7,28/288,5%</b>	<b>7,56/299,4%</b>	<b>7,41/293,7%</b>	<b>7,37/292,1%</b>
Current		A	57,00-54,10-52,30	61,80-58,70-56,70	58,80-55,80-54,00	66,60-63,30-61,10	63,60-60,40-58,40	68,40-65,00-62,80	73,20-69,60-67,20
Input power		kW	33,9	37,0	35,1	40,1	38,2	41,3	44,4
Heating capacity		kW	125,0	131,0	132,0	137,0	138,0	144,0	150,0
COP <sup>1)</sup>		W/W	4,20	4,10	4,20	4,00	4,10	4,00	4,00
<b>SCOP<sup>2)</sup> / η<sub>sh</sub></b>			<b>4,34/170,6%</b>	<b>4,35/171,0%</b>	<b>4,36/171,6%</b>	<b>4,33/170,3%</b>	<b>4,34/170,7%</b>	<b>4,35/171,2%</b>	<b>4,33/170,3%</b>
Current		A	50,51-48,02-46,38	53,71-51,02-49,28	53,20-50,60-48,90	56,91-54,02-52,18	56,40-53,60-51,80	59,60-56,60-54,70	62,80-59,60-57,60
Input power		kW	29,6	31,7	31,4	33,7	33,4	35,5	37,5
Starting current		A	1,00	1,00	1,00	1,00	1,00	1,00	1,00
External static pressure (Max)		Pa	80	80	80	80	80	80	80
Air flow		m <sup>3</sup> /min	836	836	836	836	836	836	836
Sound pressure	Normal mode (Cool / Heat)	dB(A)	67,0/69,0	68,5/71,0	67,5/69,0	69,0/72,0	68,5/71,0	69,5/72,0	70,0/73,0
	Silent mode 1 / 2 (Cool)	dB(A)	64,0/62,0	65,5/63,5	64,5/62,5	66,0/64,0	65,5/63,5	66,5/64,5	67,0/65,0
Sound power	Normal mode (Cool / Heat)	dB(A)	84,5/86,0	85,5/88,0	84,5/86,0	86,5/89,0	85,5/88,0	86,5/89,0	87,0/90,0
Dimension	H x W x D	mm	1660 x 3520 (+180) x 765	1660 x 3520 (+180) x 765	1660 x 3520 (+180) x 765	1660 x 3520 (+180) x 765	1660 x 3520 (+180) x 765	1660 x 3520 (+180) x 765	1660 x 3520 (+180) x 765
Net weight		kg	815	818	815	821	818	821	824
Piping diameter <sup>3)</sup>	Liquid	Inch (mm)	5/8(15,88)/3/4(19,05)	5/8(15,88)/3/4(19,05)	5/8(15,88)/3/4(19,05)	5/8(15,88)/3/4(19,05)	5/8(15,88)/3/4(19,05)	5/8(15,88)/3/4(19,05)	5/8(15,88)/3/4(19,05)
	Gas	Inch (mm)	1-3/8(34,96)/15/8(15,88)	1-3/8(34,96)/15/8(15,88)	1-3/8(34,96)/15/8(15,88)	1-3/8(34,96)/15/8(15,88)	1-3/8(34,96)/15/8(15,88)	1-3/8(34,96)/15/8(15,88)	1-3/8(34,96)/15/8(15,88)
	Balance	Inch (mm)	1/4(6,35)	1/4(6,35)	1/4(6,35)	1/4(6,35)	1/4(6,35)	1/4(6,35)	1/4(6,35)
Refrigerant (R32) / CO <sub>2</sub> Eq.		kg / T	27,6/18,63	29,7/20,05	27,7/18,70	31,8/21,47	29,8/20,12	31,9/21,53	34,0/22,95
Maximum allowable indoor / outdoor capacity ratio <sup>4)</sup>		%	50 ~ 130(200)	50 ~ 130(200)	50 ~ 130(200)	50 ~ 130(200)	50 ~ 130(200)	50 ~ 130(200)	50 ~ 130(200)
Operating range	Cool Min ~ Max	°C	-10 ~ +52	-10 ~ +52	-10 ~ +52	-10 ~ +52	-10 ~ +52	-10 ~ +52	-10 ~ +52
	Heat Min ~ Max	°C	-25 ~ +24	-25 ~ +24	-25 ~ +24	-25 ~ +24	-25 ~ +24	-25 ~ +24	-25 ~ +24

1) EER and COP calculation is based in accordance to EN 14511. 2) SEER / SCOP is calculated based on the seasonal space cooling / heating efficiency "η" values of the COMMISSION REGULATION (EU) 2016/2281. SEER, SCOP = (η + Correction) × PEF. 3) Piping diameter under 100 m for ultimate indoor unit / over 100 m for ultimate indoor unit (if the longest piping equivalent length exceeds 100 m, increase the sizes of the main tubes by 1 rank for gas tubes and liquid tubes). 4) If the following conditions are satisfied, the effective range is above 130% and below 200%: A. Obey the limited number of connectable indoor units. B. The lower limit of operating range for heating outdoor temperature is limited to -10 °C WB (standard -25 °C WB). C. Simultaneous operation is limited to less than 130% of connectable indoor units. 4) SEER / SCOP and η<sub>sc</sub> / η<sub>sh</sub> are in accordance with ErP test data for U2 type 4 way 90x90 cassette indoor units.

## 2-Pipe ECOi EX ME2 Series R410A

ECO*i* EX



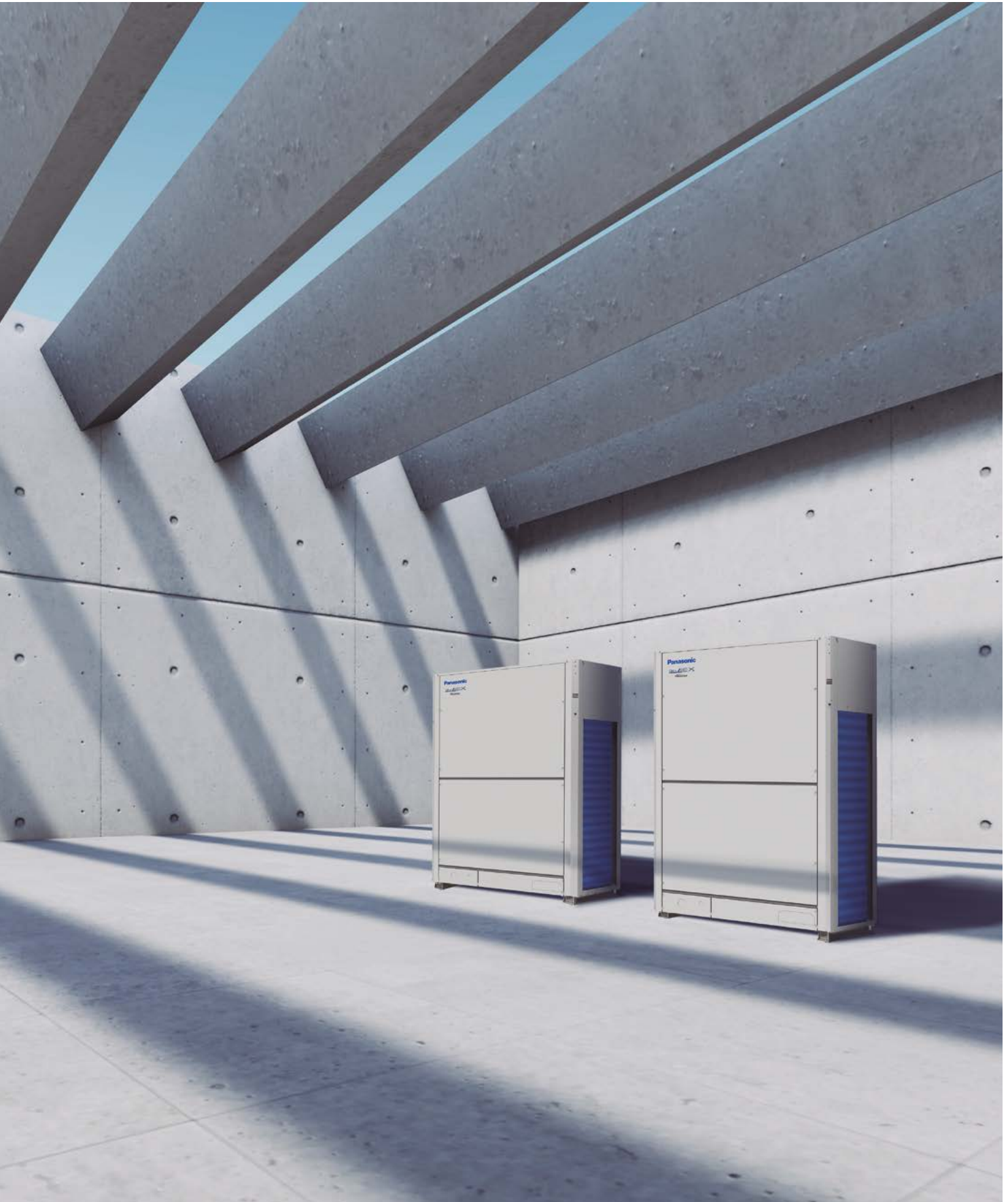

Two independently controlled Inverter compressors achieve high efficiency. Redesigned components in the body provide performance improvement especially in the rated cooling condition and EER performance\*.

\* Applicable to ECOi EX outdoor units over 14 HP (2-compressor models).



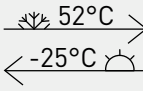
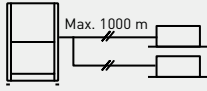

The ECOi EX can still operate at 100% capacity when the outside temperature is as high as 43 °C. This high power capability enables reliable operation even under extremely high temperature conditions.

<p><b>SEER SCOP</b></p> <p>7,56 <sup>1)</sup>    4,79 <sup>1)</sup></p>		
<p><b>High seasonal efficiency.</b></p>	<p><b>Saving installation space.</b></p>	<p><b>Silent operation.</b></p>
		
<p><b>Extended operation range.</b></p>	<p><b>Flexible piping installation.</b></p>	<p><b>Maximum indoor / outdoor capacity ratio 200%.</b></p>

**Extremely high capacity at -20 °C and unique heating capacity at -25 °C**

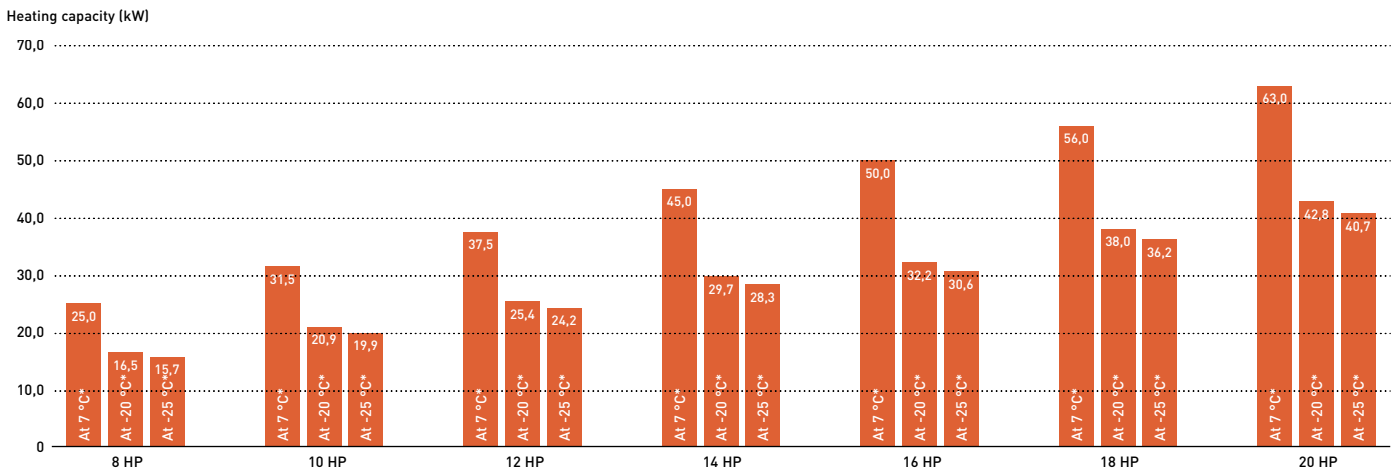

\* Outdoor air temperature (°C WB).

**High safety operation in case of breakdown!**

**Automatic Back-Up operation. Ensures heating and cooling.**

It is possible for the system to keep working, even if the compressors, fan motor and the temperature sensor are damaged (even when a compressor fails in single unit with 2 compressors inside).

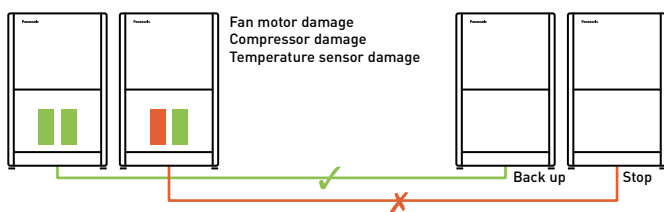

**The system will still operate with only 25% of the connected indoor units.**

System will not stop when only 25% of indoor units have power supply and breakdown on other indoor units.

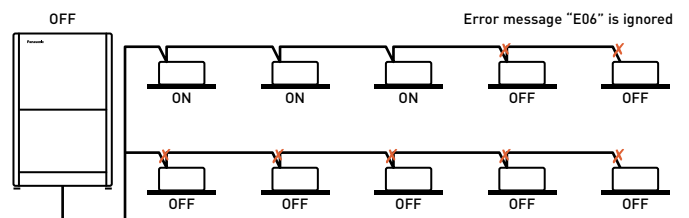

**Extended compressor life by uniform compressor operation time**

The total run-time of compressors are monitored by a built-in microcomputer, which ensures that operation times of all compressors within the same refrigerant circuit are balanced. Compressors with histories showing shorter run times are selected first, ensuring equal wear and tear across all units and extending the working life of the system.

**System example.**

A,C: DC Inverter compressor      B,D: Constant speed compressor

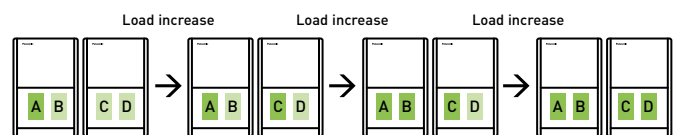

50 h 30 h 60 h 10 h

- \* Depend on accumulated operation time of each compressors.
- \* Compressor priority has possibility to be changed.
- [e.g] Case 1: A>C>B>D, Case 2: C>A>D>B, Case 3: A>C>D>B, Case 4: C>A>B>D
- \* Also other cases available.

## 2-Pipe ECOi EX ME2 Series R410A piping design.

Select installation locations so that the lengths and sizes of refrigerant piping are within the allowable ranges shown in the figure below.

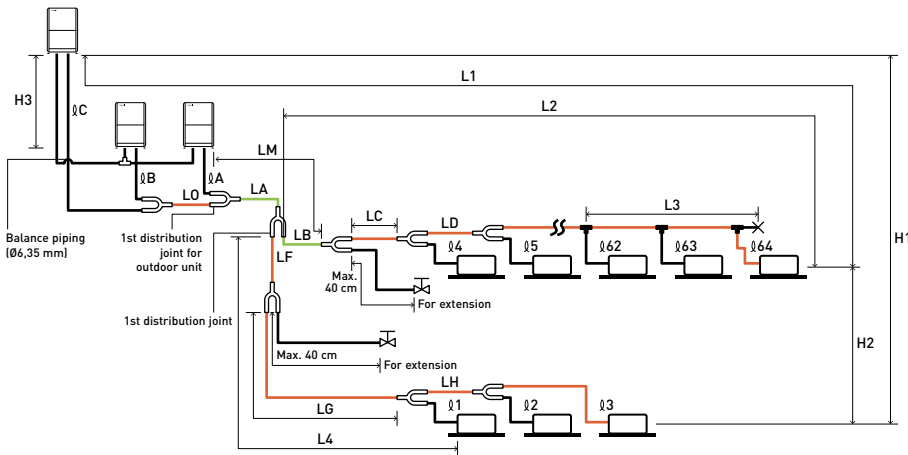

The outdoor connection main piping (LO portion) is determined by the total capacity of the outdoor units that are connected to the tube ends.

Note: Be sure to use special R410A distribution joints (CZ: optional parts) for outdoor unit connections and piping branches.

### R410A distribution joint.

- CZ-P680PH2BM (for outdoor unit)
- CZ-P1350PH2BM (for outdoor unit)
- CZ-P224BK2BM (for indoor unit)
- CZ-P680BK2BM (for indoor unit)
- CZ-P1350BK2BM (for indoor unit)

Main piping length (maximum piping size) LM= LA + LB ...

Main distribution tubes LC - LH are selected according to the capacity after the distribution joint.

Sizes of indoor unit connection piping  $\phi 1 - \phi 64$  are determined by the connection piping sizes on the indoor units.

Distribution joint (CZ: optional parts).

Ball valve (field supply).

T-joint (field supply).

Solidly welded shut (pinch weld).

### Ranges that apply to refrigerant piping lengths and to differences in installation heights

Items	Mark	Contents	Length (m)
Allowable piping length	L1	Maximum piping length	Actual length $\leq 200^{1)}$ Equivalent length $\leq 210^{1)}$
	$\Delta L (L2-L4)$	Difference between maximum length and minimum length from the 1st distribution joint	$\leq 50^{2)}$
	LM	Maximum length of main piping (at maximum size) * Even after 1st distribution joint, LM is allowed if at maximum piping length.	$\leq 50^{3)}$
	$\phi 1, \phi 2 - \phi 64$	Maximum length of each distribution tube	$\leq 50^{4)}$
	$L1 + \phi 1 + \phi 2 - \phi 63 + \phi A + \phi B + LF + LG + LH$	Total maximum piping length including length of each distribution tube (only liquid piping)	$\leq 1000$
Allowable elevation difference	$\phi A, \phi B + LO, \phi C + LO$	Maximum piping length from outdoor's 1st distribution joint to each outdoor unit	$\leq 10$
	H1	When outdoor unit is installed higher than indoor unit	$\leq 50$
	H2	When outdoor unit is installed lower than indoor unit	$\leq 40$
	H3	Maximum difference between indoor units	$\leq 15$
Allowable length of joint piping	L3	T-joint piping (field-supply); Maximum piping length between the first T-joint and solidly welded-shut end point	$\leq 2$

L = Length, H = Height

1) If the longest piping length (L1) exceeds 90 m (equivalent length), increase the sizes of the main tubes (LM) by 1 rank for gas tubes and liquid tubes. Use a field supply reducer. Select the tube size from the table of main piping sizes (Table 3) and from the table of refrigerant piping sizes (Table 8). 2) When the piping length exceeds 40 m, increase a longer liquid or gas piping by 1 rank. Refer to the Technical Data for the details. 3) If the longest main piping length (LM) exceeds 50 m, increase the main piping size at the portion before 50 m by 1 rank for the gas tubes. Use a field supply reducer. Determine the length less than the limitation of allowable maximum piping length. For the portion that exceeds 50 m, set based on the main piping size (LA) listed in Table 3. 4) If any of the piping length exceeds 30 m, increase the size of the liquid and gas tubes by 1 rank. 5) If the total distribution piping length exceeds 500 m, maximum allowable elevation difference (H2) between the indoor units is calculated by the following formula. Make sure the indoor unit's actual elevation difference should fall within the figure calculated as follows. Unit of account (meter):  $15 \times (2 - \text{total piping length (m)} \div 500)$ .

\* The outdoor connection main piping (LO portion) is determined by the total capacity of the outdoor units that are connected to the tube ends. If the size of the existing piping is already larger than the standard piping size, it is not necessary to further increase the size. \*\* If the existing piping is used, and the amount of on-site refrigerant charge exceeds the value listed below, then change the size of the piping to reduce the amount of refrigerant. Total amount of refrigerant for the system with 1 outdoor unit: 50kg. Total amount of refrigerant for the system with 2 outdoor units: 80kg. Total amount of refrigerant for the system with 3 outdoor units or 4 outdoor units: 105 kg.

### Necessary amount of additional refrigerant charge per outdoor unit.

U-8ME2E8	U-10ME2E8	U-12ME2E8	U-14ME2E8	U-16ME2E8
5,5 kg	5,5 kg	7,0 kg	7,0 kg	7,0 kg

### System limitations.

Maximum number allowable connected outdoor units	4 <sup>1)</sup>
Maximum capacity allowable connected outdoor units	224 kW (80 HP)
Maximum connectable indoor units	64 <sup>2)</sup>
Maximum allowable indoor / outdoor capacity ratio	50-130% <sup>3)</sup>

- 1) Up to 4 units can be connected if the system has been extended.
- 2) In the case of 38 HP or smaller units, the number is limited by the total capacity of the connected indoor units.
- 3) If the following conditions are satisfied, the effective range is above 130% and below 200%.
  - A) Obey the limited number of connectable indoor units. B) The lower limit of operating range for heating outdoor temperature is limited to -10 °C WB (standard -25 °C WB). C) Simultaneous operation is limited to less than 130% of connectable indoor units.

### Additional refrigerant charge.

Liquid piping size (Inch (mm))	1/4 (6,35)	3/8 (9,52)	1/2 (12,70)	5/8 (15,88)	3/4 (19,05)	7/8 (22,22)	1 (25,40)
	Amount of refrigerant charge (g/m)	26	56	128	185	259	366

### Refrigerant piping (existing piping can be used).

Piping size (mm)				Material Temper - 1/2 H, H									
Material Temper - O													
$\phi 6,35$	t 0,8	$\phi 12,70$	t 0,8	$\phi 19,05$	t 1,2	$\phi 22,22$	t 1,0	$\phi 28,58$	t 1,0	$\phi 38,10$	over t 1,35	$\phi 44,45$	over t1,55
$\phi 9,52$	t 0,8	$\phi 15,88$	t 1,0			$\phi 25,40$	t 1,0	$\phi 31,75$	t 1,1	$\phi 41,28$	over t 1,45	$\phi 44,45$	over t1,55

\* When bending the tubes, use a bending radius that is at least 4 times the outer diameter of the tubes. In addition, take sufficient care to avoid crushing or damaging the tubes when bending them.

## 2-Pipe ECOi EX ME2 Series · R410A

**A VRF system delivering energy-saving performance, powerful operation, reliability and comfort, surpassing anything previously possible. It represents a true paradigm shift in air conditioning solutions.**

VRF with outstanding energy-saving performance and powerful operation SEER 7,56 (18 HP model).

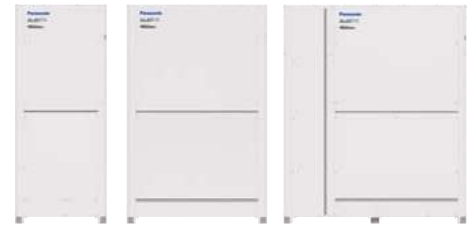

HP			8 HP	10 HP	12 HP	14 HP	16 HP	18 HP	20 HP
<b>Outdoor unit</b>			<b>U-8ME2E8</b>	<b>U-10ME2E8</b>	<b>U-12ME2E8</b>	<b>U-14ME2E8</b>	<b>U-16ME2E8</b>	<b>U-18ME2E8</b>	<b>U-20ME2E8</b>
Power supply	Voltage	V	380-400-415	380-400-415	380-400-415	380-400-415	380-400-415	380-400-415	380-400-415
	Phase		Three phase	Three phase	Three phase	Three phase	Three phase	Three phase	Three phase
	Frequency	Hz	50	50	50	50	50	50	50
Cooling capacity		kW	22,4	28,0	33,5	40,0	45,0	50,0	56,0
EER <sup>1)</sup>		W/W	4,70	4,37	3,96	3,88	3,52	3,52	3,35
ESEER		W/W	9,33	8,67	7,94	7,73	7,19	6,95	6,18
Current		A	7,79 - 7,40 - 7,14	10,70 - 10,20 - 9,80	13,70 - 13,00 - 12,50	17,40 - 16,50 - 15,90	21,10 - 20,10 - 19,40	23,20 - 22,00 - 21,20	26,70 - 25,40 - 24,50
Input power		kW	4,77	6,41	8,47	10,30	12,80	14,20	16,70
Heating capacity		kW	25,0	31,5	37,5	45,0	50,0	56,0	63,0
COP <sup>1)</sup>		W/W	5,13	4,76	4,73	4,56	4,42	4,38	3,94
Current		A	7,96 - 7,56 - 7,29	11,10 - 10,50 - 10,10	12,90 - 12,30 - 11,80	16,60 - 15,80 - 15,20	18,90 - 17,90 - 17,30	21,10 - 20,10 - 19,40	25,90 - 24,60 - 23,70
Input power		kW	4,87	6,62	7,92	9,86	11,30	12,80	16,00
Starting current		A	1,00	1,00	1,00	2,00	2,00	2,00	2,00
External static pressure [Max]		Pa	80	80	80	80	80	80	80
Air flow		m <sup>3</sup> /min	224	224	232	232	232	405	405
Sound pressure	Normal mode	dB(A)	54	56	59	60	61	59	60
	Silent mode	dB(A)	51	53	56	57	58	56	57
Sound power	Normal mode	dB(A)	75	77	80	81	82	80	81
Dimension	H x W x D	mm	1842 x 770 x 1000	1842 x 770 x 1000	1842 x 1180 x 1000	1842 x 1180 x 1000	1842 x 1180 x 1000	1842 x 1540 x 1000	1842 x 1540 x 1000
Net weight		kg	210	210	270	315	315	375	375
Piping diameter <sup>2)</sup>	Liquid	Inch (mm)	3/8(9,52)/1/2(12,70)	3/8(9,52)/1/2(12,70)	1/2(12,70)/5/8(15,88)	1/2(12,70)/5/8(15,88)	1/2(12,70)/5/8(15,88)	5/8(15,88)/3/4(19,05)	5/8(15,88)/3/4(19,05)
	Gas	Inch (mm)	3/4(19,05)/7/8(22,22)	7/8(22,22)/1(25,40)	1(25,40)/1-1/8(28,58)	1(25,40)/1-1/8(28,58)	1-1/8(28,58)/1-1/4(31,75)	1-1/8(28,58)/1-1/4(31,75)	1-1/8(28,58)/1-1/4(31,75)
	Balance	Inch (mm)	1/4(6,35)	1/4(6,35)	1/4(6,35)	1/4(6,35)	1/4(6,35)	1/4(6,35)	1/4(6,35)
Refrigerant [R410A] / CO <sub>2</sub> Eq		kg/T	5,60/11,6928	5,60/11,6928	8,30/17,3304	8,30/17,3304	8,30/17,3304	9,50/19,836	9,50/19,836
Maximum allowable indoor / outdoor capacity ratio <sup>3)</sup>		%	50 ~ 130(200)	50 ~ 130(200)	50 ~ 130(200)	50 ~ 130(200)	50 ~ 130(200)	50 ~ 130(200)	50 ~ 130(200)
Operating range	Cool Min ~ Max	°C	-10 ~ +52	-10 ~ +52	-10 ~ +52	-10 ~ +52	-10 ~ +52	-10 ~ +52	-10 ~ +52
	Heat Min ~ Max	°C	-25 ~ +18	-25 ~ +18	-25 ~ +18	-25 ~ +18	-25 ~ +18	-25 ~ +18	-25 ~ +18

### ErP data<sup>4)</sup>

<b>SEER<sup>5)</sup></b>	<b>7,43</b>	<b>6,96</b>	<b>6,74</b>	<b>7,23</b>	<b>6,43</b>	<b>7,56</b>	<b>7,03</b>
<b>η<sub>s,c</sub></b>	<b>294,3%</b>	<b>275,4%</b>	<b>266,6%</b>	<b>286,0%</b>	<b>254,3%</b>	<b>299,2%</b>	<b>278,2%</b>
<b>SCOP<sup>5)</sup></b>	<b>4,79</b>	<b>4,27</b>	<b>4,72</b>	<b>4,28</b>	<b>4,05</b>	<b>4,29</b>	<b>4,09</b>
<b>η<sub>s,h</sub></b>	<b>188,4%</b>	<b>167,6%</b>	<b>185,8%</b>	<b>168,2%</b>	<b>159,0%</b>	<b>168,7%</b>	<b>160,4%</b>

1) EER and COP calculation is based in accordance to EN 14511. 2) Piping diameter under 90 m for ultimate indoor unit / over 90 m for ultimate indoor unit (if the longest piping equivalent length exceeds 90 m, increase the sizes of the main tubes by 1 rank for gas tubes and liquid tubes). 3) If the following conditions are satisfied, the effective range is above 130% and below 200%: A. Obey the limited number of connectable indoor units. B. The lower limit of operating range for heating outdoor temperature is limited to -10 °C WB (standard -25 °C WB). C. Simultaneous operation is limited to less than 130% of connectable indoor units. 4) SEER / SCOP and η<sub>s,c</sub> / η<sub>s,h</sub> are in accordance with ErP test data for F2 type variable static pressure hide-away indoor units. 5) SEER / SCOP is calculated based on the seasonal space cooling / heating efficiency "η" values of the COMMISSION REGULATION (EU) 2016/2281. SEER, SCOP = (η + Correction) × PEF.

### Technical focus

- Twin rotary Inverter compressor
- High performance at extreme conditions
- Outstanding efficiency and comfort
- Extraordinary partial load, SEER and SCOP
- SEER and SCOP following EN-14825
- Oil recovery intelligent control
- Top comfort
- Superior flexibility
- Bluefin full line up EX
- Extremely high capacity at -20 °C and unique heating capacity at -25 °C
- Smooth exhaust flow by bell-mouth



## 2-Pipe ECOi EX ME2 Series R410A high efficiency model combination from 18 to 64 HP

HP			18 HP	20 HP	22 HP	24 HP	26 HP	28 HP
Outdoor unit			U-8ME2E8	U-10ME2E8	U-10ME2E8	U-12ME2E8	U-10ME2E8	U-12ME2E8
			U-10ME2E8	U-10ME2E8	U-12ME2E8	U-12ME2E8	U-16ME2E8	U-16ME2E8
Power supply	Voltage	V	380-400-415	380-400-415	380-400-415	380-400-415	380-400-415	380-400-415
	Phase		Three phase	Three phase	Three phase	Three phase	Three phase	Three phase
	Frequency	Hz	50	50	50	50	50	50
Cooling capacity	kW		50,0	56,0	61,5	68,0	73,0	78,5
EER <sup>1)</sup>	W/W		4,55	4,38	4,13	3,93	3,80	3,69
Current	A		18,20-17,30-16,60	21,40-20,30-19,60	24,30-23,10-22,30	28,00-26,60-25,60	31,70-30,10-29,00	34,80-33,10-31,90
Input power	kW		11,00	12,80	14,90	17,30	19,20	21,30
Heating capacity	kW		56,0	63,0	69,0	76,5	81,5	87,5
COP <sup>1)</sup>	W/W		4,96	4,77	4,76	4,69	4,55	4,56
Current	A		18,70-17,70-17,10	22,00-20,90-20,20	23,90-22,70-21,90	26,60-25,30-24,40	29,90-28,40-27,40	31,70-30,10-29,00
Input power	kW		11,30	13,20	14,50	16,30	17,90	19,20
Starting current	A		2,00	2,00	2,00	2,00	3,00	3,00
External static pressure (Max)	Pa		80	80	80	80	80	80
Air flow	m <sup>3</sup> /min		448	448	456	464	456	464
Sound pressure	Normal	dB(A)	58,5	59,0	61,0	62,0	62,5	63,5
	Silent mode	dB(A)	55,5	56,0	58,0	59,0	59,5	60,5
Sound power	Normal mode	dB(A)	79,5	80,0	82,0	83,0	83,5	84,5
Dimension / Net weight	HxWxD	mm / kg	1842 x 1600 x 1000/420	1842 x 1600 x 1000/420	1842 x 2010 x 1000/480	1842 x 2420 x 1000/540	1842 x 2010 x 1000/535	1842 x 2420 x 1000/585
Piping diameter <sup>2)</sup>	Liquid	Inch (mm)	5/8(15,88)/3/4(19,05)	5/8(15,88)/3/4(19,05)	5/8(15,88)/3/4(19,05)	5/8(15,88)/3/4(19,05)	3/4(19,05)/7/8(22,22)	3/4(19,05)/7/8(22,22)
	Gas	Inch (mm)	1-1/8(28,58)/1-1/4(31,75)	1-1/8(28,58)/1-1/4(31,75)	1-1/8(28,58)/1-1/4(31,75)	1-1/8(28,58)/1-1/4(31,75)	1-1/4(31,75)/1-1/2(38,10)	1-1/4(31,75)/1-1/2(38,10)
	Balance	Inch (mm)	1/4(6,35)	1/4(6,35)	1/4(6,35)	1/4(6,35)	1/4(6,35)	1/4(6,35)
Refrigerant (R410A) / CO <sub>2</sub> Eq.	kg / T		11,20/23,3856	11,20/23,3856	13,90/29,0232	16,60/34,6608	13,90/29,0232	16,60/34,6608
Maximum allowable indoor / outdoor capacity ratio <sup>3)</sup>	%		50-130(200)	50-130(200)	50-130(200)	50-130(200)	50-130(200)	50-130(200)
Operating range	Cool Min - Max	°C	-10 ~ +52	-10 ~ +52	-10 ~ +52	-10 ~ +52	-10 ~ +52	-10 ~ +52
	Heat Min - Max	°C	-25 ~ +18	-25 ~ +18	-25 ~ +18	-25 ~ +18	-25 ~ +18	-25 ~ +18

HP			30 HP	32 HP	34 HP	36 HP	38 HP	40 HP
Outdoor unit			U-14ME2E8	U-16ME2E8	U-10ME2E8	U-12ME2E8	U-10ME2E8	U-12ME2E8
			U-16ME2E8	U-16ME2E8	U-12ME2E8	U-12ME2E8	U-12ME2E8	U-16ME2E8
Power supply	Voltage	V	380-400-415	380-400-415	380-400-415	380-400-415	380-400-415	380-400-415
	Phase		Three phase	Three phase	Three phase	Three phase	Three phase	Three phase
	Frequency	Hz	50	50	50	50	50	50
Cooling capacity	kW		85,0	90,0	96,0	101,0	107,0	113,0
EER <sup>1)</sup>	W/W		3,68	3,52	4,05	3,95	3,84	3,75
Current	A		38,60-36,60-35,30	42,30-40,20-38,70	38,70-36,80-35,50	41,40-39,30-37,90	46,10-43,80-42,20	49,20-46,70-45,00
Input power	kW		23,10	25,60	23,70	25,60	27,90	30,10
Heating capacity	kW		95,0	100,0	108,0	113,0	119,0	127,0
COP <sup>1)</sup>	W/W		4,48	4,42	4,72	4,73	4,61	4,57
Current	A		35,40-33,60-32,40	37,70-35,80-34,60	37,80-35,90-34,60	39,00-37,10-35,80	42,60-40,50-39,00	45,90-43,60-42,00
Input power	kW		21,20	22,60	22,90	23,90	25,80	27,80
Starting current	A		4,00	4,00	3,00	3,00	4,00	4,00
External static pressure (Max)	Pa		80	80	80	80	80	80
Air flow	m <sup>3</sup> /min		464	464	688	696	688	696
Sound pressure	Normal	dB(A)	63,5	64,0	63,0	64,0	64,0	64,5
	Silent mode	dB(A)	60,5	61,0	60,0	61,0	61,0	61,5
Sound power	Normal mode	dB(A)	84,5	85,0	84,0	85,0	85,0	85,5
Dimension / Net weight	HxWxD	mm / kg	1842 x 2420 x 1000/630	1842 x 2420 x 1000/630	1842 x 3250 x 1000/750	1842 x 3660 x 1000/810	1842 x 3250 x 1000/795	1842 x 3660 x 1000/855
Piping diameter <sup>2)</sup>	Liquid	Inch (mm)	3/4(19,05)/7/8(22,22)	3/4(19,05)/7/8(22,22)	3/4(19,05)/7/8(22,22)	3/4(19,05)/7/8(22,22)	3/4(19,05)/7/8(22,22)	3/4(19,05)/7/8(22,22)
	Gas	Inch (mm)	1-1/4(31,75)/1-1/2(38,10)	1-1/4(31,75)/1-1/2(38,10)	1-1/4(31,75)/1-1/2(38,10)	1-1/2(38,10)/1-5/8(41,28)	1-1/2(38,10)/1-5/8(41,28)	1-1/2(38,10)/1-5/8(41,28)
	Balance	Inch (mm)	1/4(6,35)	1/4(6,35)	1/4(6,35)	1/4(6,35)	1/4(6,35)	1/4(6,35)
Refrigerant (R410A) / CO <sub>2</sub> Eq.	kg / T		16,60/34,6608	16,60/34,6608	22,20/46,3536	24,90/51,9912	22,20/46,3536	24,90/46,3536
Maximum allowable indoor / outdoor capacity ratio <sup>3)</sup>	%		50-130(200)	50-130(200)	50-130(200)	50-130(200)	50-130(200)	50-130(200)
Operating range	Cool Min - Max	°C	-10 ~ +52	-10 ~ +52	-10 ~ +52	-10 ~ +52	-10 ~ +52	-10 ~ +52
	Heat Min - Max	°C	-25 ~ +18	-25 ~ +18	-25 ~ +18	-25 ~ +18	-25 ~ +18	-25 ~ +18

Data is for reference. 1) EER and COP calculation is based in accordance to EN 14511. 2) Piping diameter under 90 m for ultimate indoor unit / over 90 m for ultimate indoor unit (if the longest piping equivalent length exceeds 90 m, increase the sizes of the main tubes by 1 rank for gas tubes and liquid tubes). 3) If the following conditions are satisfied, the effective range is above 130% and below 200%: A. Obey the limited number of connectable indoor units. B. The lower limit of operating range for heating outdoor temperature is limited to -10 °C WB (standard -25 °C WB). C. Simultaneous operation is limited to less than 130% of connectable indoor units.

HP			42 HP	44 HP	46 HP	48 HP	50 HP	52 HP
			U-10ME2E8	U-12ME2E8	U-14ME2E8	U-16ME2E8	U-10ME2E8	U-12ME2E8
	Outdoor unit		U-16ME2E8	U-16ME2E8	U-16ME2E8	U-16ME2E8	U-12ME2E8	U-12ME2E8
			U-16ME2E8	U-16ME2E8	U-16ME2E8	U-16ME2E8	U-12ME2E8	U-16ME2E8
Power supply	Voltage	V	380 - 400 - 415	380 - 400 - 415	380 - 400 - 415	380 - 400 - 415	380 - 400 - 415	380 - 400 - 415
	Phase		Three phase	Three phase	Three phase	Three phase	Three phase	Three phase
	Frequency	Hz	50	50	50	50	50	50
Cooling capacity		kW	118,0	124,0	130,0	135,0	140,0	145,0
EER <sup>1)</sup>		W/W	3,69	3,62	3,62	3,52	3,87	3,82
Current		A	52,80 - 50,20 - 48,40	56,00 - 53,20 - 51,30	59,90 - 56,90 - 54,90	63,40 - 60,20 - 58,10	59,10 - 56,20 - 54,20	62,10 - 59,00 - 56,80
Input power		kW	32,00	34,30	35,90	38,40	36,20	38,00
Heating capacity		kW	132,0	138,0	145,0	150,0	155,0	160,0
COP <sup>1)</sup>		W/W	4,49	4,50	4,46	4,42	4,65	4,66
Current		A	49,10 - 46,60 - 44,90	50,70 - 48,20 - 46,40	54,30 - 51,50 - 49,70	56,60 - 53,80 - 51,80	55,00 - 52,20 - 50,40	56,60 - 53,80 - 51,90
Input power		kW	29,40	30,70	32,50	33,90	33,30	34,30
Starting current		A	5,00	5,00	6,00	6,00	5,00	5,00
External static pressure (Max)		Pa	80	80	80	80	80	80
Air flow		m <sup>3</sup> /min	688	696	696	696	920	928
Sound pressure	Normal	dB(A)	65,0	65,5	65,5	66,0	65,5	66,0
	Silent mode	dB(A)	62,0	62,5	62,5	63,0	62,5	63,0
Sound power	Normal mode	dB(A)	86,0	86,5	86,5	87,0	86,5	87,0
Dimension / Net weight	H x W x D	mm / kg	1842 x 3250 x 1000 / 840	1842 x 3660 x 1000 / 900	1842 x 3660 x 1000 / 945	1842 x 3660 x 1000 / 945	1842 x 4490 x 1000 / 1065	1842 x 4900 x 1000 / 1125
	Piping diameter <sup>2)</sup>							
Piping diameter <sup>2)</sup>	Liquid	Inch (mm)	3/4 (19,05) / 7/8 (22,22)	3/4 (19,05) / 7/8 (22,22)	3/4 (19,05) / 7/8 (22,22)	3/4 (19,05) / 7/8 (22,22)	3/4 (19,05) / 7/8 (22,22)	3/4 (19,05) / 7/8 (22,22)
	Gas	Inch (mm)	1-1/2 (38,10) / 1-5/8 (41,28)	1-1/2 (38,10) / 1-5/8 (41,28)	1-1/2 (38,10) / 1-5/8 (41,28)	1-1/2 (38,10) / 1-5/8 (41,28)	1-1/2 (38,10) / 1-5/8 (41,28)	1-1/2 (38,10) / 1-5/8 (41,28)
	Balance	Inch (mm)	1/4 (6,35)	1/4 (6,35)	1/4 (6,35)	1/4 (6,35)	1/4 (6,35)	1/4 (6,35)
Refrigerant (R410A) / CO <sub>2</sub> Eq.		kg / T	22,20 / 51,9912	24,90 / 51,9912	24,90 / 51,9912	24,90 / 51,9912	30,50 / 63,6840	33,20 / 69,3216
Maximum allowable indoor / outdoor capacity ratio <sup>3)</sup>		%	50 - 130 (200)	50 - 130 (200)	50 - 130 (200)	50 - 130 (200)	50 - 130 (200)	50 - 130 (200)
Operating range	Cool Min ~ Max	°C	-10 ~ +52	-10 ~ +52	-10 ~ +52	-10 ~ +52	-10 ~ +52	-10 ~ +52
	Heat Min ~ Max	°C	-25 ~ +18	-25 ~ +18	-25 ~ +18	-25 ~ +18	-25 ~ +18	-25 ~ +18

HP			54 HP	56 HP	58 HP	60 HP	62 HP	64 HP
			U-10ME2E8	U-12ME2E8	U-10ME2E8	U-12ME2E8	U-14ME2E8	U-16ME2E8
	Outdoor unit		U-12ME2E8	U-12ME2E8	U-16ME2E8	U-16ME2E8	U-16ME2E8	U-16ME2E8
			U-16ME2E8	U-16ME2E8	U-16ME2E8	U-16ME2E8	U-16ME2E8	U-16ME2E8
Power supply	Voltage	V	380 - 400 - 415	380 - 400 - 415	380 - 400 - 415	380 - 400 - 415	380 - 400 - 415	380 - 400 - 415
	Phase		Three phase	Three phase	Three phase	Three phase	Three phase	Three phase
	Frequency	Hz	50	50	50	50	50	50
Cooling capacity		kW	151,0	156,0	162,0	168,0	174,0	180,0
EER <sup>1)</sup>		W/W	3,75	3,71	3,65	3,60	3,60	3,52
Current		A	66,60 - 63,20 - 60,90	68,80 - 65,30 - 63,00	73,30 - 69,70 - 67,10	77,10 - 73,30 - 70,60	79,80 - 75,80 - 73,00	84,60 - 80,30 - 77,40
Input power		kW	40,30	42,10	44,40	46,70	48,30	51,20
Heating capacity		kW	169,0	175,0	182,0	189,0	195,0	201,0
COP <sup>1)</sup>		W/W	4,56	4,56	4,47	4,47	4,45	4,42
Current		A	61,90 - 58,80 - 56,70	63,40 - 60,20 - 58,10	68,00 - 64,60 - 62,20	70,60 - 67,10 - 64,70	73,10 - 69,50 - 67,00	76,00 - 72,20 - 69,60
Input power		kW	37,10	38,40	40,70	42,30	43,80	45,50
Starting current		A	6,00	6,00	7,00	7,00	8,00	8,00
External static pressure (Max)		Pa	80	80	80	80	80	80
Air flow		m <sup>3</sup> /min	920	928	920	928	928	928
Sound pressure	Normal	dB(A)	66,0	66,5	66,5	67,0	67,0	67,0
	Silent mode	dB(A)	63,0	63,5	63,5	64,0	64,0	64,0
Sound power	Normal mode	dB(A)	87,0	87,5	87,5	88,0	88,0	88,0
Dimension / Net weight	H x W x D	mm / kg	1842 x 4490 x 1000 / 1110	1842 x 4900 x 1000 / 1170	1842 x 4490 x 1000 / 1155	1842 x 4900 x 1000 / 1215	1842 x 4900 x 1000 / 1260	1842 x 4900 x 1000 / 1260
	Piping diameter <sup>2)</sup>							
Piping diameter <sup>2)</sup>	Liquid	Inch (mm)	3/4 (19,05) / 7/8 (22,22)	3/4 (19,05) / 7/8 (22,22)	3/4 (19,05) / 7/8 (22,22)	3/4 (19,05) / 7/8 (22,22)	3/4 (19,05) / 7/8 (22,22)	3/4 (19,05) / 7/8 (22,22)
	Gas	Inch (mm)	1-1/2 (38,10) / 1-5/8 (41,28)	1-1/2 (38,10) / 1-5/8 (41,28)	1-1/2 (38,10) / 1-5/8 (41,28)	1-1/2 (38,10) / 1-5/8 (41,28)	1-5/8 (41,28) / 1-3/4 (44,45)	1-5/8 (41,28) / 1-3/4 (44,45)
	Balance	Inch (mm)	1/4 (6,35)	1/4 (6,35)	1/4 (6,35)	1/4 (6,35)	1/4 (6,35)	1/4 (6,35)
Refrigerant (R410A) / CO <sub>2</sub> Eq.		kg / T	30,50 / 63,6840	33,20 / 69,3216	30,50 / 63,6840	33,20 / 69,3216	33,20 / 69,3216	33,20 / 69,3216
Maximum allowable indoor / outdoor capacity ratio <sup>3)</sup>		%	50 - 130 (200)	50 - 130 (200)	50 - 130 (200)	50 - 130 (200)	50 - 130 (200)	50 - 130 (200)
Operating range	Cool Min ~ Max	°C	-10 ~ +52	-10 ~ +52	-10 ~ +52	-10 ~ +52	-10 ~ +52	-10 ~ +52
	Heat Min ~ Max	°C	-25 ~ +18	-25 ~ +18	-25 ~ +18	-25 ~ +18	-25 ~ +18	-25 ~ +18

Data is for reference. 1) EER and COP calculation is based in accordance to EN 14511. 2) Piping diameter under 90 m for ultimate indoor unit / over 90 m for ultimate indoor unit (if the longest piping equivalent length exceeds 90 m, increase the sizes of the main tubes by 1 rank for gas tubes and liquid tubes). 3) If the following conditions are satisfied, the effective range is above 130% and below 200%: A. Obey the limited number of connectable indoor units. B. The lower limit of operating range for heating outdoor temperature is limited to -10 °C WB [standard -25 °C WB]. C. Simultaneous operation is limited to less than 130% of connectable indoor units.

## 2-Pipe ECOi EX ME2 Series R410A space saving model combination from 22 to 80 HP

HP			22 HP	24 HP	26 HP	28 HP	30 HP	32 HP	34 HP	
	Outdoor unit		U-10ME2E8 U-12ME2E8	U-12ME2E8 U-12ME2E8	U-10ME2E8 U-16ME2E8	U-12ME2E8 U-16ME2E8	U-14ME2E8 U-16ME2E8	U-16ME2E8 U-16ME2E8	U-16ME2E8 U-16ME2E8	U-14ME2E8 U-20ME2E8
Power supply	Voltage	V	380-400-415	380-400-415	380-400-415	380-400-415	380-400-415	380-400-415	380-400-415	380-400-415
	Phase		Three phase	Three phase	Three phase	Three phase	Three phase	Three phase	Three phase	Three phase
	Frequency	Hz	50	50	50	50	50	50	50	50
Cooling capacity		kW	61,5	68,0	73,0	78,5	85,0	90,0	96,0	
EER <sup>1)</sup>		W/W	4,13	3,93	3,80	3,69	3,68	3,52	3,56	
SEER <sup>2)</sup>			<b>6,90</b>	<b>6,86</b>	<b>6,62</b>	<b>6,60</b>	<b>6,88</b>	<b>6,55</b>	<b>7,21</b>	
Current		A	24,30-23,10-22,30	28,00-26,60-25,60	31,70-30,10-29,00	34,80-33,10-31,90	38,60-36,60-35,30	42,30-40,20-38,70	44,10-41,90-40,40	
Input power		kW	14,90	17,30	19,20	21,30	23,10	25,60	27,00	
Heating capacity		kW	69,0	76,5	81,5	87,5	95,0	100,0	108,0	
COP <sup>1)</sup>		W/W	4,76	4,69	4,55	4,56	4,48	4,42	4,17	
SCOP <sup>2)</sup>			<b>4,53</b>	<b>4,78</b>	<b>4,16</b>	<b>4,29</b>	<b>4,13</b>	<b>4,09</b>	<b>4,14</b>	
Current		A	23,90-22,70-21,90	26,60-25,30-24,40	29,90-28,40-27,40	31,70-30,10-29,00	35,40-33,60-32,40	37,70-35,80-34,60	42,80-40,60-39,20	
Input power		kW	14,50	16,30	17,90	19,20	21,20	22,60	25,90	
Starting current		A	2,00	2,00	3,00	3,00	4,00	4,00	4,00	
External static pressure (Max)		Pa	80	80	80	80	80	80	80	
Air flow		m <sup>3</sup> /min	456	464	456	464	464	464	637	
Sound pressure	Normal / Silent mode	dB(A)	61,0/58,0	62,0/59,0	62,5/59,5	63,5/60,5	63,5/60,5	64,0/61,0	63,0/60,0	
Sound power	Normal mode	dB(A)	82,0	83,0	83,5	84,5	84,5	85,0	84,0	
Dimension / Net weight	HxWxD	mm / kg	1842x2010 x1000/480	1842x2420 x1000/540	1842x2010 x1000/525	1842x2420 x1000/585	1842x2420 x1000/630	1842x2420 x1000/630	1842x2780 x1000/690	
Piping diameter <sup>3)</sup>	Liquid	Inch (mm)	5/8(15,88)/ 3/4(19,05)	5/8(15,88)/ 3/4(19,05)	3/4(19,05)/ 7/8(22,22)	3/4(19,05)/ 7/8(22,22)	3/4(19,05)/ 7/8(22,22)	3/4(19,05)/ 7/8(22,22)	3/4(19,05)/ 7/8(22,22)	
	Gas	Inch (mm)	1-1/8(28,58)/ 1-1/4(31,75)	1-1/8(28,58)/ 1-1/4(31,75)	1-1/4(31,75)/ 1-1/2(38,10)	1-1/4(31,75)/ 1-1/2(38,10)	1-1/4(31,75)/ 1-1/2(38,10)	1-1/4(31,75)/ 1-1/2(38,10)	1-1/4(31,75)/ 1-1/2(38,10)	
	Balance	Inch (mm)	1/4(6,35)	1/4(6,35)	1/4(6,35)	1/4(6,35)	1/4(6,35)	1/4(6,35)	1/4(6,35)	
Refrigerant (R410A) / CO <sub>2</sub> Eq.		kg / T	13,90/23,3856	16,60/34,6608	13,90/29,0232	16,60/34,6608	16,60/34,6608	16,60/34,6608	17,80/37,1664	
Maximum allowable indoor / outdoor capacity ratio <sup>4)</sup>		%	50 ~ 130(200)	50 ~ 130(200)	50 ~ 130(200)	50 ~ 130(200)	50 ~ 130(200)	50 ~ 130(200)	50 ~ 130(200)	
Operating range	Cool Min - Max	°C	-10 ~ +52	-10 ~ +52	-10 ~ +52	-10 ~ +52	-10 ~ +52	-10 ~ +52	-10 ~ +52	
	Heat Min - Max	°C	-25 ~ +18	-25 ~ +18	-25 ~ +18	-25 ~ +18	-25 ~ +18	-25 ~ +18	-25 ~ +18	

HP			36 HP	38 HP	40 HP	42 HP	44 HP	46 HP	48 HP
	Outdoor unit		U-16ME2E8 U-20ME2E8	U-18ME2E8 U-20ME2E8	U-20ME2E8 U-20ME2E8	U-10ME2E8 U-16ME2E8	U-12ME2E8 U-16ME2E8	U-14ME2E8 U-16ME2E8	U-16ME2E8 U-16ME2E8
Power supply	Voltage	V	380-400-415	380-400-415	380-400-415	380-400-415	380-400-415	380-400-415	380-400-415
	Phase		Three phase	Three phase	Three phase	Three phase	Three phase	Three phase	Three phase
	Frequency	Hz	50	50	50	50	50	50	50
Cooling capacity		kW	101,0	107,0	113,0	118,0	124,0	130,0	135,0
EER <sup>1)</sup>		W/W	3,42	3,42	3,34	3,69	3,62	3,62	3,52
SEER <sup>2)</sup>			<b>6,86</b>	<b>7,32</b>	<b>7,16</b>	<b>6,57</b>	<b>6,60</b>	<b>6,70</b>	<b>6,55</b>
Current		A	47,70-45,30-43,70	50,60-48,10-46,30	54,10-51,40-49,50	52,80-50,20-48,40	56,00-53,20-51,30	59,90-56,90-54,90	63,40-60,20-58,10
Input power		kW	25,9	31,3	33,8	32,0	34,3	35,9	38,4
Heating capacity		kW	113,0	119,0	127,0	132,0	138,0	145,0	150,0
COP <sup>1)</sup>		W/W	4,14	4,13	3,92	4,49	4,50	4,46	4,42
SCOP <sup>2)</sup>			<b>4,06</b>	<b>4,14</b>	<b>4,13</b>	<b>4,11</b>	<b>4,21</b>	<b>4,12</b>	<b>4,09</b>
Current		A	44,60-42,40-40,80	47,10-44,70-43,10	52,40-49,80-48,00	49,10-46,60-44,90	50,70-48,20-46,40	54,30-51,50-49,7	56,60-53,80-51,8
Input power		kW	27,30	28,80	32,40	29,40	30,70	32,50	33,90
Starting current		A	4,00	4,00	4,00	5,00	5,00	6,00	6,00
External static pressure (Max)		Pa	80	80	80	80	80	80	80
Air flow		m <sup>3</sup> /min	637	810	810	688	696	696	696
Sound pressure	Normal / Silent mode	dB(A)	63,5/60,5	62,5/59,5	63,0/60,0	65,0/62,0	65,5/62,5	65,5/62,5	66,0/63,0
Sound power	Normal mode	dB(A)	84,5	83,5	84,0	86,0	86,5	86,5	87,0
Dimension / Net weight	HxWxD	mm / kg	1842x2780 x1000/690	1842x3140 x1000/750	1842x3140 x1000/750	1842x3250 x1000/840	1842x3660 x1000/900	1842x3660 x1000/945	1842x3660 x1000/945
Piping diameter <sup>3)</sup>	Liquid	Inch (mm)	3/4(19,05)/ 7/8(22,22)	3/4(19,05)/ 7/8(22,22)	3/4(19,05)/ 7/8(22,22)	3/4(19,05)/ 7/8(22,22)	3/4(19,05)/ 7/8(22,22)	3/4(19,05)/ 7/8(22,22)	3/4(19,05)/ 7/8(22,22)
	Gas	Inch (mm)	1-1/2(38,10)/ 1-5/8(41,28)	1-1/2(38,10)/ 1-5/8(41,28)	1-1/2(38,10)/ 1-5/8(41,28)	1-1/2(38,10)/ 1-5/8(41,28)	1-1/2(38,10)/ 1-5/8(41,28)	1-1/2(38,10)/ 1-5/8(41,28)	1-1/2(38,10)/ 1-5/8(41,28)
	Balance	Inch (mm)	1/4(6,35)	1/4(6,35)	1/4(6,35)	1/4(6,35)	1/4(6,35)	1/4(6,35)	1/4(6,35)
Refrigerant (R410A) / CO <sub>2</sub> Eq.		kg / T	17,80/37,1664	19,00/39,672	19,00/39,672	22,20/46,3536	24,90/51,9912	24,90/51,9912	24,90/51,9912
Maximum allowable indoor / outdoor capacity ratio <sup>4)</sup>		%	50 ~ 130(200)	50 ~ 130(200)	50 ~ 130(200)	50 ~ 130(200)	50 ~ 130(200)	50 ~ 130(200)	50 ~ 130(200)
Operating range	Cool Min - Max	°C	-10 ~ +52	-10 ~ +52	-10 ~ +52	-10 ~ +52	-10 ~ +52	-10 ~ +52	-10 ~ +52
	Heat Min - Max	°C	-25 ~ +18	-25 ~ +18	-25 ~ +18	-25 ~ +18	-25 ~ +18	-25 ~ +18	-25 ~ +18

1) EER and COP calculation is based in accordance to EN 14511. 2) SEER / SCOP is calculated based on the seasonal space cooling / heating efficiency "η" values of the COMMISSION REGULATION (EU) 2016/2281. SEER, SCOP = (η + Correction) × PEF. 3) Piping diameter under 90 m for ultimate indoor unit / over 90 m for ultimate outdoor unit (if the longest piping equivalent length exceeds 90 m, increase the sizes of the main tubes by 1 rank for gas tubes and liquid tubes). 4) If the following conditions are satisfied, the effective range is above 130% and below 200%: A. Obey the limited number of connectable indoor units. B. The lower limit of operating range for heating outdoor temperature is limited to -10 °C WB (standard -25 °C WB). C. Simultaneous operation is limited to less than 130% of connectable indoor units.

HP			50 HP	52 HP	54 HP	56 HP	58 HP	60 HP	62 HP	64 HP
Outdoor unit			U-14ME2E8	U-16ME2E8	U-14ME2E8	U-16ME2E8	U-18ME2E8	U-20ME2E8	U-14ME2E8	U-16ME2E8
			U-16ME2E8	U-16ME2E8	U-20ME2E8	U-20ME2E8	U-20ME2E8	U-20ME2E8	U-16ME2E8	U-16ME2E8
			U-20ME2E8	U-20ME2E8	U-20ME2E8	U-20ME2E8	U-20ME2E8	U-20ME2E8	U-16ME2E8	U-16ME2E8
Power supply	Voltage	V	380-400-415	380-400-415	380-400-415	380-400-415	380-400-415	380-400-415	380-400-415	380-400-415
	Phase		Three phase	Three phase	Three phase	Three phase	Three phase	Three phase	Three phase	Three phase
	Frequency	Hz	50	50	50	50	50	50	50	50
Cooling capacity	kW		140,0	145,0	151,0	156,0	162,0	168,0	174,0	180,0
EER <sup>1)</sup>	W/W		3,55	3,46	3,49	3,41	3,40	3,35	3,60	3,52
SEER <sup>2)</sup>			<b>6,96</b>	<b>6,72</b>	<b>7,16</b>	<b>6,92</b>	<b>7,30</b>	<b>7,16</b>	<b>6,68</b>	<b>6,55</b>
Current	A		64,40-61,10-58,90	68,50-65,00-62,70	70,00-66,50-64,10	74,00-70,30-67,80	76,90-73,10-70,40	80,10-76,10-73,40	79,80-75,80-73,00	84,60-80,30-77,40
Input power	kW		39,40	41,90	43,30	45,80	47,60	50,10	48,30	51,20
Heating capacity	kW		155,0	160,0	169,0	175,0	182,0	189,0	195,0	201,0
COP <sup>1)</sup>	W/W		4,29	4,27	4,11	4,08	4,06	3,94	4,45	4,42
SCOP <sup>3)</sup>			<b>4,08</b>	<b>4,05</b>	<b>4,13</b>	<b>4,07</b>	<b>4,13</b>	<b>4,13</b>	<b>4,11</b>	<b>4,09</b>
Current	A		59,60-56,60-54,60	61,90-58,80-56,70	67,10-63,80-61,50	70,10-66,60-64,20	73,20-69,50-67,00	77,60-73,70-71,00	73,10-69,50-67,00	76,00-72,20-69,6
Input power	kW		36,10	37,50	41,10	42,90	44,80	48,00	43,80	45,50
Starting current	A		6,00	6,00	6,00	6,00	6,00	6,00	8,00	8,00
External static pressure (Max)	Pa		80	80	80	80	80	80	80	80
Air flow	m <sup>3</sup> /min		869	869	1042	1042	1215	1215	928	928
Sound pressure	Normal / Silent mode	dB(A)	65,5/62,5	65,5/62,5	65,0/62,0	65,5/62,5	64,5/61,5	65,0/62,0	67,0/64,0	67,0/64,0
Sound power	Normal mode	dB(A)	86,5	86,5	86,0	86,5	85,5	86,0	88,0	88,0
Dimension / Net weight	H x W x D	mm / kg	1842 x 4020 x 1000/1005	1842 x 4020 x 1000/1005	1842 x 4380 x 1000/1065	1842 x 4380 x 1000/1065	1842 x 4740 x 1000/1125	1842 x 4740 x 1000/1125	1842 x 4900 x 1000/1260	1842 x 4900 x 1000/1260
Piping diameter <sup>3)</sup>	Liquid	Inch (mm)	3/4(19,05)/7/8(22,22)	3/4(19,05)/7/8(22,22)	3/4(19,05)/7/8(22,22)	3/4(19,05)/7/8(22,22)	3/4(19,05)/7/8(22,22)	3/4(19,05)/7/8(22,22)	3/4(19,05)/7/8(22,22)	3/4(19,05)/7/8(22,22)
	Gas	Inch (mm)	1-1/2(38,10)/1-5/8(41,28)	1-1/2(38,10)/1-5/8(41,28)	1-1/2(38,10)/1-5/8(41,28)	1-1/2(38,10)/1-5/8(41,28)	1-1/2(38,10)/1-5/8(41,28)	1-1/2(38,10)/1-5/8(41,28)	1-5/8(41,28)/1-3/4(44,45)	1-5/8(41,28)/1-3/4(44,45)
	Balance	Inch (mm)	1/4(6,35)	1/4(6,35)	1/4(6,35)	1/4(6,35)	1/4(6,35)	1/4(6,35)	1/4(6,35)	1/4(6,35)
Refrigerant (R410A) / CO <sub>2</sub> Eq.	kg / T		26,10/54,4968	26,10/54,4968	27,30/57,0024	27,30/57,0024	28,50/59,508	28,50/59,508	33,20/69,3216	33,20/69,3216
Maximum allowable indoor / outdoor capacity ratio <sup>4)</sup>	%		50 ~ 130(200)	50 ~ 130(200)	50 ~ 130(200)	50 ~ 130(200)	50 ~ 130(200)	50 ~ 130(200)	50 ~ 130(200)	50 ~ 130(200)
Operating range	Cool Min ~ Max	°C	-10 ~ +52	-10 ~ +52	-10 ~ +52	-10 ~ +52	-10 ~ +52	-10 ~ +52	-10 ~ +52	-10 ~ +52
	Heat Min ~ Max	°C	-25 ~ +18	-25 ~ +18	-25 ~ +18	-25 ~ +18	-25 ~ +18	-25 ~ +18	-25 ~ +18	-25 ~ +18

HP			66 HP	68 HP	70 HP	72 HP	74 HP	76 HP	78 HP	80 HP
Outdoor unit			U-10ME2E8	U-12ME2E8	U-10ME2E8	U-16ME2E8	U-16ME2E8	U-16ME2E8	U-18ME2E8	U-20ME2E8
			U-16ME2E8	U-16ME2E8	U-20ME2E8	U-16ME2E8	U-18ME2E8	U-20ME2E8	U-20ME2E8	U-20ME2E8
			U-20ME2E8	U-20ME2E8	U-20ME2E8	U-20ME2E8	U-20ME2E8	U-20ME2E8	U-20ME2E8	U-20ME2E8
Power supply	Voltage	V	380-400-415	380-400-415	380-400-415	380-400-415	380-400-415	380-400-415	380-400-415	380-400-415
	Phase		Three phase	Three phase	Three phase	Three phase	Three phase	Three phase	Three phase	Three phase
	Frequency	Hz	50	50	50	50	50	50	50	50
Cooling capacity	kW		185,0	190,0	196,0	202,0	208,0	213,0	219,0	224,0
EER <sup>1)</sup>	W/W		3,52	3,49	3,47	3,42	3,42	3,39	3,38	3,35
SEER <sup>2)</sup>			<b>6,92</b>	<b>6,91</b>	<b>7,09</b>	<b>6,86</b>	<b>7,03</b>	<b>7,01</b>	<b>7,18</b>	<b>7,16</b>
Current	A		85,00-80,80-77,80	88,10-83,70-80,70	91,30-86,80-83,60	95,40-90,60-87,30	98,30-93,40-90,00	101,70-96,60-93,10	103,50-98,30-94,70	106,80-101,50-97,80
Input power	kW		52,60	54,50	56,50	59,00	60,80	62,90	64,70	66,80
Heating capacity	kW		207,0	213,0	219,0	226,0	233,0	239,0	245,0	252,0
COP <sup>1)</sup>	W/W		4,16	4,18	4,05	4,14	4,12	4,03	4,03	3,94
SCOP <sup>3)</sup>			<b>4,11</b>	<b>4,17</b>	<b>4,13</b>	<b>4,06</b>	<b>4,12</b>	<b>4,07</b>	<b>4,13</b>	<b>4,13</b>
Current	A		81,20-77,10-74,30	83,30-79,20-76,30	87,40-83,10-80,10	89,20-84,70-81,70	92,30-87,70-84,50	96,90-92,00-88,70	98,30-93,40-90,00	103,40-98,30-94,70
Input power	kW		49,70	51,00	54,10	56,60	56,50	59,30	60,80	64,00
Starting current	A		7,00	7,00	7,00	8,00	8,00	8,00	8,00	8,00
External static pressure (Max)	Pa		80	80	80	80	80	80	80	80
Air flow	m <sup>3</sup> /min		1266	1274	1439	1274	1447	1447	1620	1620
Sound pressure	Normal / Silent mode	dB(A)	66,0/63,0	66,5/63,5	65,5/62,5	66,5/63,5	66,5/63,5	66,5/63,5	66,0/63,0	66,0/63,0
Sound power	Normal mode	dB(A)	87,0	87,5	86,5	87,5	87,5	87,5	87,0	87,0
Dimension / Net weight	H x W x D	mm / kg	1842 x 5210 x 1000/1275	1842 x 5620 x 1000/1335	1842 x 5570 x 1000/1335	1842 x 5620 x 1000/1380	1842 x 5980 x 1000/1440	1842 x 5980 x 1000/1440	1842 x 6340 x 1000/1500	1842 x 6340 x 1000/1500
Piping diameter <sup>3)</sup>	Liquid	Inch (mm)	3/4(19,05)/7/8(22,22)	7/8(22,22)/1(25,04)	7/8(22,22)/1(25,04)	7/8(22,22)/1(25,04)	7/8(22,22)/1(25,04)	7/8(22,22)/1(25,04)	7/8(22,22)/1(25,04)	7/8(22,22)/1(25,04)
	Gas	Inch (mm)	1-5/8(41,28)/1-3/4(44,45)	1-5/8(41,28)/1-3/4(44,45)	1-5/8(41,28)/1-3/4(44,45)	1-3/4(44,45)/2(50,80)	1-3/4(44,45)/2(50,80)	1-3/4(44,45)/2(50,80)	1-3/4(44,45)/2(50,80)	1-3/4(44,45)/2(50,80)
	Balance	Inch (mm)	1/4(6,35)	1/4(6,35)	1/4(6,35)	1/4(6,35)	1/4(6,35)	1/4(6,35)	1/4(6,35)	1/4(6,35)
Refrigerant (R410A) / CO <sub>2</sub> Eq.	kg / T		32,90/68,6952	35,60/74,3328	34,10/19,836	35,80/68,6952	36,80/76,8384	36,80/76,8384	38,00/79,344	38,00/79,344
Maximum allowable indoor / outdoor capacity ratio <sup>4)</sup>	%		50 ~ 130(200)	50 ~ 130(200)	50 ~ 130(200)	50 ~ 130(200)	50 ~ 130(200)	50 ~ 130(200)	50 ~ 130(200)	50 ~ 130(200)
Operating range	Cool Min ~ Max	°C	-10 ~ +52	-10 ~ +52	-10 ~ +52	-10 ~ +52	-10 ~ +52	-10 ~ +52	-10 ~ +52	-10 ~ +52
	Heat Min ~ Max	°C	-25 ~ +18	-25 ~ +18	-25 ~ +18	-25 ~ +18	-25 ~ +18	-25 ~ +18	-25 ~ +18	-25 ~ +18

1) EER and COP calculation is based in accordance to EN 14511. 2) SEER / SCOP is calculated based on the seasonal space cooling / heating efficiency "η" values of the COMMISSION REGULATION (EU) 2016/2281. SEER, SCOP = (η + Correction) × PEF. 3) Piping diameter under 90 m for ultimate indoor unit / over 90 m for ultimate indoor unit (if the longest piping equivalent length exceeds 90 m, increase the sizes of the main tubes by 1 rank for gas tubes and liquid tubes). 4) If the following conditions are satisfied, the effective range is above 130% and below 200%: A. Obey the limited number of connectable indoor units. B. The lower limit of operating range for heating outdoor temperature is limited to -10 °C WB (standard -25 °C WB). C. Simultaneous operation is limited to less than 130% of connectable indoor units.

# 3-Pipe ECOi EX MF3 Series R410A



Simultaneous heating and cooling VRF system.  
 The Panasonic 3-Pipe ECOi EX MF3 Series offers the best solution for the most discerning customers and demanding installations.

## Simultaneous heating and cooling VRF System

The Panasonic 3-Pipe ECOi EX MF3 Series offers the ideal solution to meet customer's demands.

### Upgraded energy efficiency utilized ECOi EX technology.

- SEER / SCOP improved in full capacities from 8 to 16 HP
- SEER / SCOP follows LOT21 (January 2018)
- Eurovent certified EER / COP

### Design flexibility.

- High reliability even under extreme temperature conditions
- Connection of up to 52 indoor units
- Slim heat recovery box with just 200 mm height
- Farthest piping length between indoor and outdoor units: 200 m

Excellent seasonal energy saving.

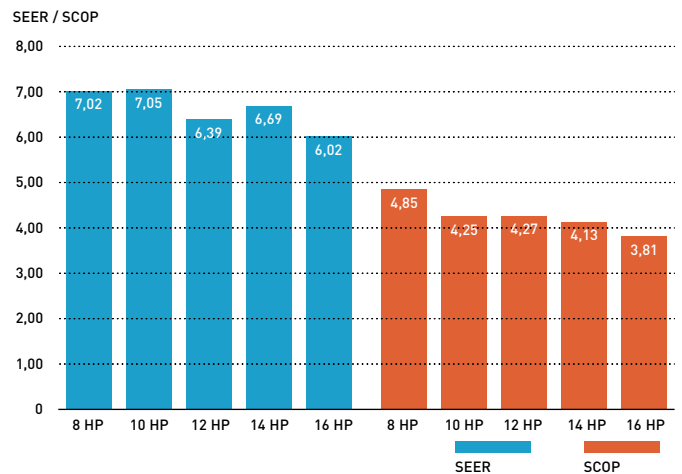

## Extended design operation conditions

Cooling design operation conditions: The cooling operating range has been extended to -10 °C ~ 52 °C by changing the outdoor fan to an Inverter type.

Heating design operation conditions: Stable heating operation even with an outside air temperature of -20 °C. The heating operating range has been extended to -20 °C by use of a compressor with a high-pressure vessel.

Cooling design operation conditions.

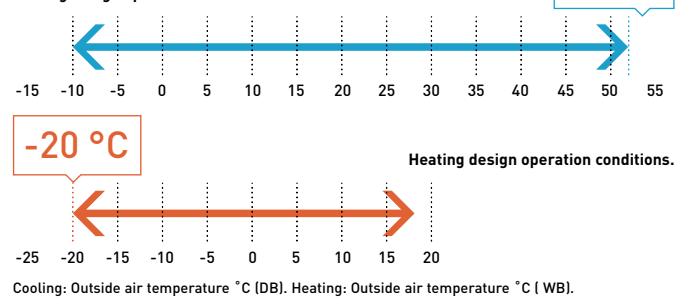

## Wide temperature setting range

Wired remote controller heating temperature setting range is 16 to 30 °C as standard.

## Increased maximum number of connectable indoor units

Maximum 48 HP with 52 indoor units can be set up according to user needs. Connectable indoor / outdoor unit capacity ratio up to 150%.

System ( HP)	8	10	12	14	16	18	20	22	24	26	28	30	32	34	36	38	40	42	44	46	48
Connectable indoor units*: 150%	19	24	29	34	39	43	48	52					52								

\*Depending on indoor units types. Please check service manuals.

## Power suppression control for energy saving (demand control) <sup>1)</sup>

The 3-Pipe ECOi EX MF3 Series has a built-in demand function which uses the Inverter characteristics. With this demand function, the power consumption can be set in three steps, and operation <sup>2)</sup> at optimum performance is performed according to the setting and the power consumption. This function is useful to reduce the annual power consumption and to save electricity costs while maintaining comfort.

1) An outdoor Seri-Para I/O unit is required for demand input.

2) Setting is possible as 0% or in the range from 40 to 100% (in steps of 5%). At the time of shipping, setting has been done to the three steps of 0%, 70%, and 100%.



# Slim 3-Pipe control box kit / Multiple connection type

Heat recovery Box to connect multiple indoor units with just one box, 4, 6 and up to 8 indoor units or groups.



The height is only 200 mm, which is especially advantageous in hotel applications, where space for connecting several boxes is limited.

## Individual control of multiple indoor units with solenoid valve kits.

- Any design and layout can be used in a single system.
- Cooling operation is possible with an outdoor temperature of -10 °C.

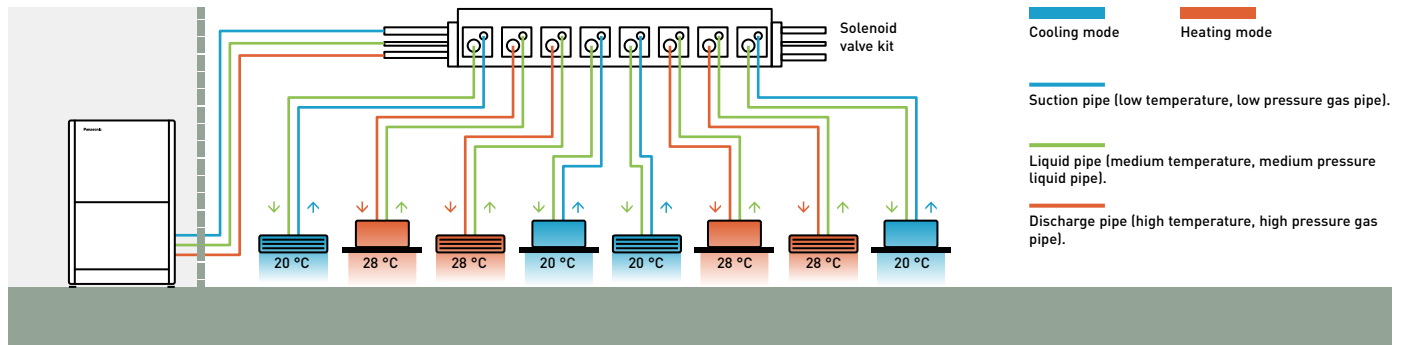
System structure.

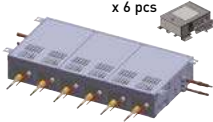
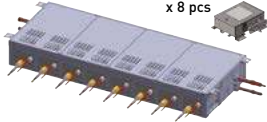

				
	<b>1 port</b>	<b>4 port</b>	<b>6 port</b>	<b>8 port</b>
<b>56 type</b>	<b>CZ-P56HR3</b>	<b>CZ-P456HR3</b>	<b>CZ-P656HR3</b>	<b>CZ-P856HR3</b>
<b>160 type</b>	<b>CZ-P160HR3</b>	<b>CZ-P4160HR3</b>	—	—

## Solenoid valve kit / wiring work

### Single connection type.

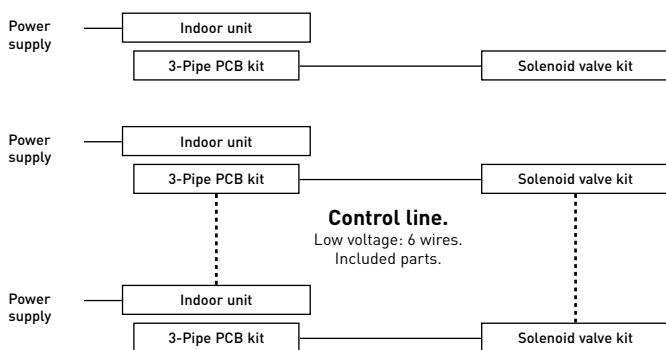

### Multiple connection type.

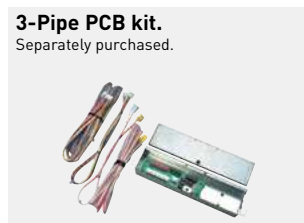
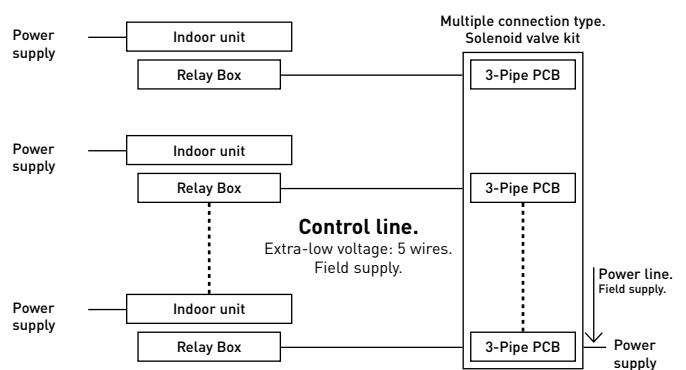

# 3-Pipe ECOi EX MF3 Series R410A superior flexibility

## Increased piping lengths and design flexibility

Adaptable to various building types and sizes. Actual piping length: 200 m. Maximum piping length: 500 m.

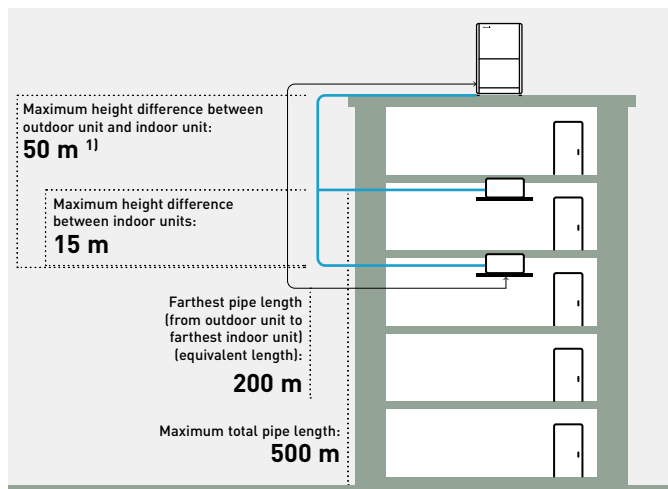

1) 40 m if the outdoor unit is below the indoor unit.

## Up to 40 m piping after first branch

Up to 52 units can be connected to one system. Flexible piping layout makes it easier to design systems for locations such as train stations, airports, schools and hospitals.

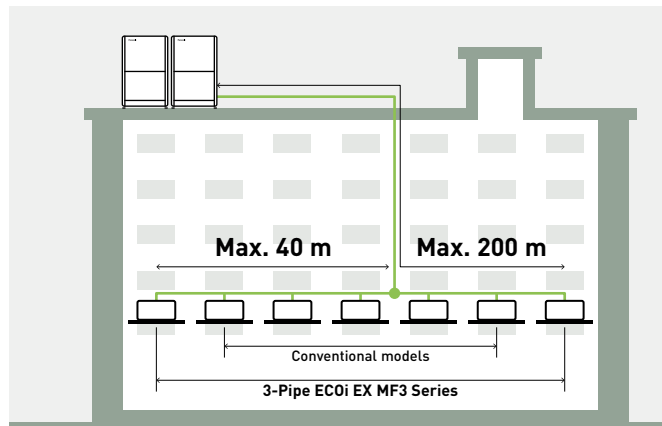

## Excellent cost saving and smaller piping size

By using R410A with low pressure loss, pipe sizes for discharge, suction and liquid are all reduced. This makes it possible to aim for reduced piping space, improved workability at the site, and reduction of the piping material costs.

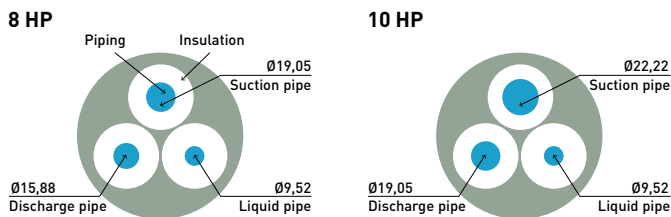

## High external static pressure on condensers

With an efficient fan shape, fan guard, motor, and casing, the models can be custom-installed on-site to provide up to 80 Pa of external static pressure.

An air discharge duct prevents air flow short-circuiting, allowing outdoor units to be installed on every floor of a building.



Fan.

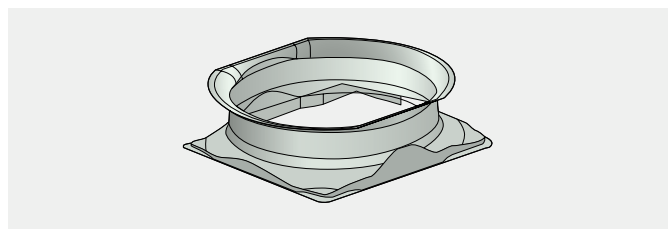

Bell-mouth casing.

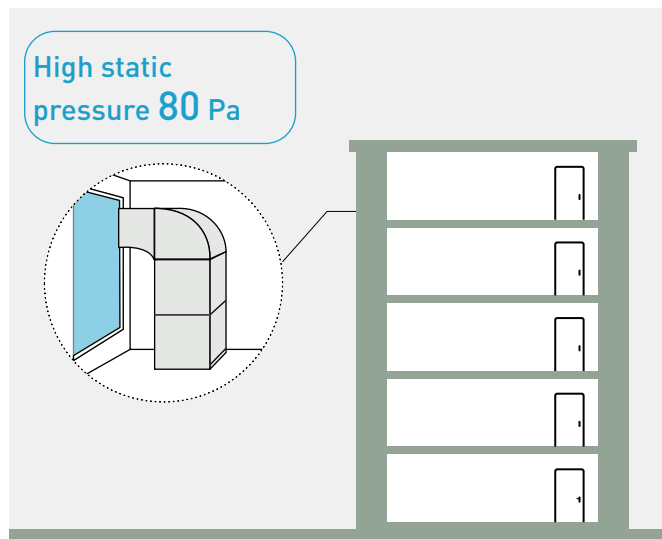

### 3-Pipe ECOi EX MF3 Series R410A piping design.

Select installation locations so that the lengths and sizes of refrigerant piping are within the allowable ranges shown in the figure below.

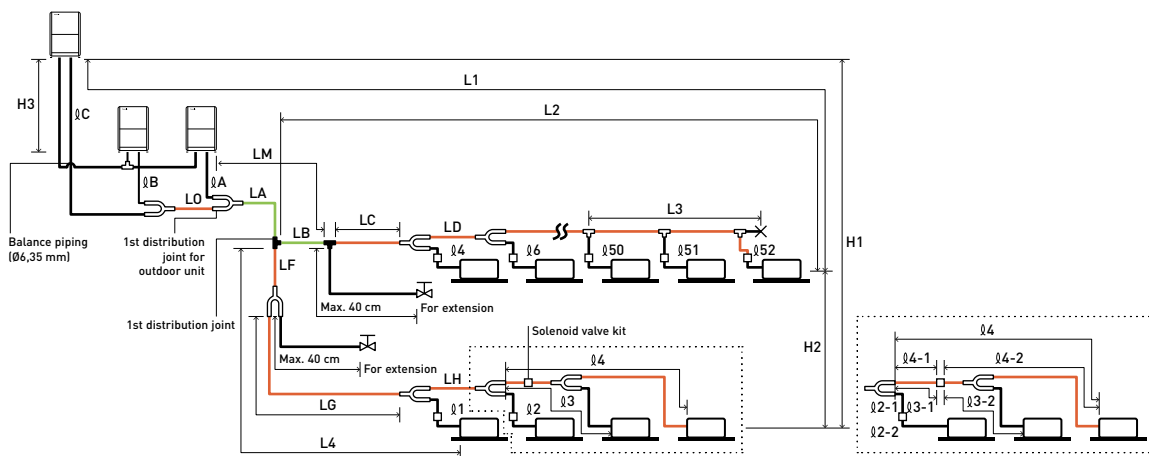

The outdoor connection main piping (LO portion) is determined by the total capacity of the outdoor units that are connected to the tube ends.  
 Note: Be sure to use special R410A distribution joints (CZ: optional parts) for outdoor unit connections and piping branches.

**R410A distribution joint.**  
 CZ-P680PJ2BM (for outdoor unit)  
 CZ-P1350PJ2BM (for outdoor unit)  
 CZ-P224BH2BM (for indoor unit)  
 CZ-P680BH2BM (for indoor unit)  
 CZ-P1350BH2BM (for indoor unit)

Main piping length (maximum piping size)  $LM = LA + LB \dots$

Main distribution tubes LC - LH are selected according to the capacity after the distribution joint.

Sizes of indoor unit connection piping  $\phi 1 - \phi 52$  are determined by the connection piping sizes on the indoor units.

Distribution joint (CZ: optional parts).

Ball valve (field supply).

T-joint (field supply).

Solidly welded shut (pinch weld).

#### Ranges that apply to refrigerant piping lengths and to differences in installation heights

Items	Mark	Contents	Length (m)
Allowable piping length	L1	Maximum piping length	Actual length $\leq 200^{1)}$ Equivalent length $\leq 210^{1)}$
	$\Delta L$ (L2-L4)	Difference between maximum length and minimum length from the 1st distribution joint	$\leq 50^{2)}$
	LM	Maximum length of main piping (at maximum size) * Even after 1st distribution joint, LM is allowed if at maximum piping length.	— <sup>3)</sup>
	$\phi 1, \phi 2 - \phi 52$	Maximum length of each distribution tube	$\leq 50^{4)}$
	$L1 + \phi 1 + \phi 2 - \phi 51 + \phi A + \phi B + LF + LG + LH$	Total maximum piping length including length of each distribution tube (only liquid piping)	$\leq 500$
Allowable elevation difference	$\phi A, \phi B + LO, \phi C + LO$	Maximum piping length from outdoor's 1st distribution joint to each outdoor unit	$\leq 10$
	$\phi 1-2, \phi 2-2 - \phi 52-2$	Maximum length between solenoid valve kit and indoor unit	$\leq 30$
	H1	When outdoor unit is installed higher than indoor unit	$\leq 50$
	H2	When outdoor unit is installed lower than indoor unit	$\leq 40$
Allowable length of joint piping	H3	Maximum difference between indoor units	$\leq 15^{5)}$
	H3	Maximum difference between outdoor units	$\leq 4$
Allowable length of joint piping	L3	T-joint piping (field-supply); Maximum piping length between the first T-joint and solidly welded-shut end point	$\leq 2$

L = Length, H = Height

1) If the longest piping length (L1) exceeds 90 m (equivalent length), increase the sizes of the main pipes (LM) by 1 rank for suction pipes, discharge pipes and liquid pipes. Use a field supply reducer. Select the pipe size from the table of main piping sizes (Table 3) and from the table of refrigerant piping sizes (Table 8). 2) If the longest main piping length (LM) exceeds 50 m, increase the main piping size at the portion before 50 m by 1 rank for the suction pipes and discharge pipes. Use a field supply reducer. Determine the length less than the limitation of allowable maximum piping length. For the portion that exceeds 50 m, set based on the main piping size (LA) listed in Table 3. 3) If the piping length marked "L" (L2-L4) exceeds 40 m, increase the piping size at the portion after the 1st distribution joint by 1 rank for the liquid pipe, suction pipe and discharge pipe. Refer to the Technical Data for the details. 4) If any of the piping length exceeds 30 m, increase the size of the suction pipes, discharge pipes and liquid pipes by 1 rank.

\* The outdoor connection main piping (LO portion) is determined by the total capacity of the outdoor units that are connected to the pipe ends.

#### System limitations.

Maximum number allowable connected outdoor units	3
Maximum capacity allowable connected outdoor units	135 kW (48 HP)
Maximum connectable indoor units	52
Maximum allowable indoor / outdoor capacity ratio	50-150%

1) In the case of 24 HP (type 68 kW) or smaller units, the number is limited by the total capacity of the connected indoor units.  
 2) Up to 3 units can be connected if the system has been extended.  
 3) It is strongly recommended that you choose the unit so the load can become between 50 and 130%.

#### Additional refrigerant charge.

Liquid piping size (Inch (mm))	1/4 (6,35)	3/8 (9,52)	1/2 (12,70)	5/8 (15,88)	3/4 (19,05)	7/8 (22,22)
Amount of refrigerant charge (g/m)	26	56	128	185	259	366

#### Necessary amount of additional refrigerant charge per meter, according to discharge piping size.

Discharge piping size	Inch (mm)	1/2 (12,70)	5/8 (15,88)	3/4 (19,05)	7/8 (22,22)	1 (25,40)	1-1/8 (28,58)	1-1/4 (31,75)	1-1/2 (38,10)
Additional amount	g/m	12	21	31	41	55	71	89	126

#### Refrigerant piping.

Piping size (mm)				Material Temper - 0				Material Temper - 1/2 H, H			
$\phi 6,35$	t 0,8	$\phi 12,70$	t 0,8	$\phi 19,05$	t 1,2	$\phi 22,22$	t 1,0	$\phi 28,58$	t 1,0	$\phi 38,10$	t 1,15
$\phi 9,52$	t 0,8	$\phi 15,88$	t 1,0			$\phi 25,40$	t 1,0	$\phi 31,75$	t 1,1	$\phi 41,28$	t 1,20

\* When bending the tubes, use a bending radius that is at least 4 times the outer diameter of the tubes. In addition, take sufficient care to avoid crushing or damaging the tubes when bending them.

## 3-Pipe ECOi EX MF3 Series - R410A

## Simultaneous heating and cooling operation with heat recovery type.

The 3-Pipe ECOi EX MF3 Series is one of the most advanced VRF systems.

Not only highly efficient performance for simultaneous heating and cooling, but also sophisticated installation and maintenance capability.

4,85  
SCOP

HP			8 HP	10 HP	12 HP	14 HP	16 HP
Outdoor unit			U-8MF3E8	U-10MF3E8	U-12MF3E8	U-14MF3E8	U-16MF3E8
Power supply	Voltage	V	380 - 400 - 415	380 - 400 - 415	380 - 400 - 415	380 - 400 - 415	380 - 400 - 415
	Phase		Three phase	Three phase	Three phase	Three phase	Three phase
	Frequency	Hz	50	50	50	50	50
Cooling capacity		kW	22,4	28,0	33,5	40,0	45,0
	EER <sup>1)</sup>	W/W	5,11	4,72	3,91	3,70	3,49
Current		A	7,16 - 6,80 - 6,55	9,90 - 9,41 - 9,07	3,19 - 13,20 - 12,70	18,20 - 17,30 - 16,70	21,30 - 20,20 - 19,50
Input power		kW	4,38	5,93	8,57	10,80	12,90
Heating capacity		kW	25,0	31,5	37,5	45,0	50,0
	COP <sup>1)</sup>	W/W	5,25	5,17	4,51	4,21	4,17
Current		A	7,78 - 7,39 - 7,12	10,20 - 9,66 - 9,31	13,40 - 12,80 - 12,30	18,10 - 17,20 - 16,50	20,00 - 19,00 - 18,30
Input power		kW	4,76	6,09	8,32	10,70	12,00
Starting current		A	1,00	1,00	1,00	2,00	2,00
External static pressure [Max]		Pa	80	80	80	80	80
Air flow		m <sup>3</sup> /min	210	220	232	232	232
Sound pressure	Normal mode	dB(A)	54,0	57,0	60,0	61,0	62,0
	Silent mode 1 / 2	dB(A)	51,0/49,0	54,0/52,0	57,0/55,0	58,0/56,0	59,0/57,0
Sound power	Normal mode	dB(A)	76,0	78,0	81,0	82,0	82,0
Dimension	HxWxD	mm	1842x1180x1000	1842x1180x1000	1842x1180x1000	1842x1180x1000	1842x1180x1000
Net weight		kg	261	262	286	334	334
Piping diameter <sup>2)</sup>	Liquid	Inch (mm)	3/8(9,52)/1/2(12,70)	3/8(9,52)/1/2(12,70)	1/2(12,70)/5/8(15,88)	1/2(12,70)/5/8(15,88)	1/2(12,70)/5/8(15,88)
	Discharge	Inch (mm)	5/8(15,88)/3/4(19,05)	3/4(19,05)/7/8(22,22)	3/4(19,05)/7/8(22,22)	7/8(22,22)/1(25,40)	7/8(22,22)/1(25,40)
	Suction	Inch (mm)	3/4(19,05)/7/8(22,22)	7/8(22,22)/1(25,40)	1(25,40)/1-1/8(28,58)	1(25,40)/1-1/8(28,58)	1-1/8(28,58)/1-1/4(31,75)
	Balance	Inch (mm)	1/4(6,35)	1/4(6,35)	1/4(6,35)	1/4(6,35)	1/4(6,35)
Refrigerant (R410A) / CO <sub>2</sub> Eq.		kg / T	6,80/14,1984	6,80/14,1984	8,30/17,3304	8,30/17,3304	8,30/17,3304
Maximum allowable indoor / outdoor capacity ratio		%	50 - 150	50 - 150	50 - 150	50 - 150	50 - 150
Operating range	Cool Min - Max	°C	-10 ~ +52	-10 ~ +52	-10 ~ +52	-10 ~ +52	-10 ~ +52
	Heat Min - Max	°C	-20 ~ +18	-20 ~ +18	-20 ~ +18	-20 ~ +18	-20 ~ +18
	Simultaneous op.	°C	-10 ~ +24	-10 ~ +24	-10 ~ +24	-10 ~ +24	-10 ~ +24

ErP data <sup>3)</sup>							
SEER <sup>4)</sup>			7,02	7,05	6,39	6,69	6,02
$\eta_{s,c}$			277,7%	278,9%	252,7%	264,4%	237,7%
SCOP <sup>4)</sup>			4,85	4,25	4,27	4,13	3,81
$\eta_{s,h}$			190,9%	166,8%	167,8%	162,1%	149,3%

1) EER and COP calculation is based in accordance to EN 14511. 2) Piping diameter under 90 m for ultimate indoor unit / over 90 m for ultimate indoor unit (if the longest piping equivalent length exceeds 90 m, increase the sizes of the main tubes by 1 rank for gas tubes and liquid tubes). 3) SEER / SCOP and  $\eta_{s,c}$  /  $\eta_{s,h}$  are in accordance with ErP test data for F2 type variable static pressure hide-away indoor units. 4) SEER / SCOP is calculated based on the seasonal space cooling / heating efficiency " $\eta$ " values of the COMMISSION REGULATION (EU) 2016/2281. SEER, SCOP = ( $\eta$  + Correction) × PEF.

Solenoid valve kit	
KIT-P56HR3	3-Pipe control solenoid valve kit (up to 5,6 kW)
CZ-P56HR3	Solenoid valve kit (up to 5,6 kW)
CZ-CAPE2	3-Pipe control PCB
KIT-P160HR3	3-Pipe control solenoid valve kit (from 5,6 to 16,0 kW)
CZ-P160HR3	Solenoid valve kit (from 5,6 kW to 16,0 kW)
CZ-CAPE2	3-Pipe control PCB
CZ-CAPEK2 <sup>5)</sup>	3-Pipe control PCB for wall-mounted

3-Pipe control box kit	
CZ-P456HR3	4 ports 3 pipe box (up to 5,6 kW per port)
CZ-P656HR3	6 ports 3 pipe box (up to 5,6 kW per port)
CZ-P856HR3	8 ports 3 pipe box (up to 5,6 kW per port)
CZ-P4160HR3	4 ports 3 pipe box (up to 16,0 kW per port)

5) Available for S-45/56/73/106MK3E.

- Achieving SCOP 4,85 top class in the industry (LOT21 Seasonal heating efficiency value for 8 HP outdoor unit)
- Simultaneous cooling and heating operation with up to 39 indoor units
- Slim heat recovery boxes with just 200 mm height fit with the ceiling space limited in hotel applications

### Technical focus

- High SEER / SCOP at full Load capacity (follows LOT21)
- Eurovent certified EER / COP
- Standardisation of outdoor unit to one compact casing size
- Connection of up to 52 indoor units
- High external static pressure 80 Pa with an efficient fan shape, fan guard, motor, and casing
- Silent outdoor unit operation: Minimum 54 dB(A) for 8 HP
- Bluefin coil coating as standard



3-Pipe ECOi EX MF3 Series R410A combination from 18 to 48 HP

HP			18 HP	20 HP	22 HP	24 HP	26 HP	28 HP	30 HP	32 HP
Outdoor unit			U-8MF3E8	U-8MF3E8	U-10MF3E8	U-12MF3E8	U-10MF3E8	U-12MF3E8	U-14MF3E8	U-16MF3E8
			U-10MF3E8	U-12MF3E8	U-12MF3E8	U-12MF3E8	U-16MF3E8	U-16MF3E8	U-16MF3E8	U-16MF3E8
			U-10MF3E8	U-12MF3E8	U-12MF3E8	U-12MF3E8	U-16MF3E8	U-16MF3E8	U-16MF3E8	U-16MF3E8
Power supply	Voltage	V	380-400-415	380-400-415	380-400-415	380-400-415	380-400-415	380-400-415	380-400-415	380-400-415
	Phase		Three phase	Three phase	Three phase	Three phase	Three phase	Three phase	Three phase	Three phase
	Frequency	Hz	50	50	50	50	50	50	50	50
Cooling capacity	kW		50,0	56,0	61,5	68,0	73,0	78,5	85,0	90,0
EER <sup>1)</sup>	W/W		4,90	4,31	4,24	3,89	3,88	3,65	3,59	3,49
Current	A		16,80-16,00-15,40	21,00-20,00-19,20	23,70-22,50-21,70	28,30-26,90-25,90	31,00-29,50-28,40	35,10-33,40-32,20	39,60-37,60-36,20	42,60-40,50-39,00
Input power	kW		10,20	13,00	14,50	17,50	18,80	21,50	23,70	25,8
Heating capacity	kW		56,0	63,0	69,0	76,5	81,5	87,5	95,0	100,0
COP <sup>1)</sup>	W/W		5,23	4,77	4,79	4,47	4,50	4,31	4,19	4,17
Current	A		17,70-16,80-16,20	21,30-20,30-19,50	23,50-22,30-21,50	27,60-26,30-25,30	30,20-28,70-27,70	33,50-31,80-30,70	37,90-36,00-34,70	40,10-38,10-36,70
Input power	kW		10,70	13,20	14,40	17,10	18,10	20,30	22,70	24,00
Starting current	A		2,00	2,00	2,00	2,00	3,00	3,00	4,00	4,00
External static pressure (Max)	Pa		80	80	80	80	80	80	80	80
Air flow	m <sup>3</sup> /min		430	442	452	464	452	464	464	464
Sound pressure	Normal mode	dB(A)	59,0	61,0	62,0	63,0	63,5	64,5	64,5	65,0
	Silent mode 1 / 2	dB(A)	56,0/54,0	58,0/56,0	59,0/57,0	60,0/58,0	60,5/58,5	61,5/59,5	61,5/59,5	62,0/60,0
Sound power	Normal mode	dB(A)	81,5	84,0	84,5	86,0	84,5	86,0	86,0	86,0
Dimension	HxWxD	mm	1842 x 2360 (+60) x 1000	1842 x 2360 (+60) x 1000	1842 x 2360 (+60) x 1000	1842 x 2360 (+60) x 1000	1842 x 2360 (+60) x 1000	1842 x 2360 (+60) x 1000	1842 x 2360 (+60) x 1000	1842 x 2360 (+60) x 1000
Net weight	kg		523	547	548	574	596	620	668	668
Piping diameter <sup>2)</sup>	Liquid	Inch (mm)	5/8 (15,88) / 3/4 (19,05)	5/8 (15,88) / 3/4 (19,05)	5/8 (15,88) / 3/4 (19,05)	5/8 (15,88) / 3/4 (19,05)	3/4 (19,05) / 7/8 (22,22)	3/4 (19,05) / 7/8 (22,22)	3/4 (19,05) / 7/8 (22,22)	3/4 (19,05) / 7/8 (22,22)
	Discharge	Inch (mm)	7/8 (22,22) / 1 (25,40)	7/8 (22,22) / 1 (25,40)	1 (25,40) / 1-1/8 (28,58)	1 (25,40) / 1-1/8 (28,58)	1 (25,40) / 1-1/8 (28,58)	1-1/8 (28,58) / 1-1/4 (31,75)	1-1/8 (28,58) / 1-1/4 (31,75)	1-1/8 (28,58) / 1-1/4 (31,75)
	Suction	Inch (mm)	1-1/8 (28,58) / 1-1/4 (31,75)	1-1/8 (28,58) / 1-1/4 (31,75)	1-1/8 (28,58) / 1-1/4 (31,75)	1-1/8 (28,58) / 1-1/4 (31,75)	1-1/4 (31,75) / 1-1/2 (38,10)	1-1/4 (31,75) / 1-1/2 (38,10)	1-1/4 (31,75) / 1-1/2 (38,10)	1-1/4 (31,75) / 1-1/2 (38,10)
	Balance	Inch (mm)	1/4 (6,35)	1/4 (6,35)	1/4 (6,35)	1/4 (6,35)	1/4 (6,35)	1/4 (6,35)	1/4 (6,35)	1/4 (6,35)
Refrigerant (R410A) / CO <sub>2</sub> Eq.	kg / T		13,60/28,3968	15,10/31,5288	15,10/31,5288	16,60/34,6608	15,10/31,5288	16,60/34,6608	16,60/34,6608	16,60/34,6608
Maximum allowable indoor / outdoor capacity ratio	%		50 ~ 150	50 ~ 150	50 ~ 150	50 ~ 150	50 ~ 150	50 ~ 150	50 ~ 150	50 ~ 150
Operating range	Cool Min ~ Max	°C	-10 ~ +52	-10 ~ +52	-10 ~ +52	-10 ~ +52	-10 ~ +52	-10 ~ +52	-10 ~ +52	-10 ~ +52
	Heat Min ~ Max	°C	-20 ~ +18	-20 ~ +18	-20 ~ +18	-20 ~ +18	-20 ~ +18	-20 ~ +18	-20 ~ +18	-20 ~ +18
	Simultaneous op.	°C	-10 ~ +24	-10 ~ +24	-10 ~ +24	-10 ~ +24	-10 ~ +24	-10 ~ +24	-10 ~ +24	-10 ~ +24

HP			34 HP	36 HP	38 HP	40 HP	42 HP	44 HP	46 HP	48 HP
Outdoor unit			U-8MF3E8	U-8MF3E8	U-10MF3E8	U-8MF3E8	U-10MF3E8	U-12MF3E8	U-14MF3E8	U-16MF3E8
			U-10MF3E8	U-12MF3E8	U-12MF3E8	U-16MF3E8	U-16MF3E8	U-16MF3E8	U-16MF3E8	U-16MF3E8
			U-16MF3E8	U-16MF3E8	U-16MF3E8	U-16MF3E8	U-16MF3E8	U-16MF3E8	U-16MF3E8	U-16MF3E8
Power supply	Voltage	V	380-400-415	380-400-415	380-400-415	380-400-415	380-400-415	380-400-415	380-400-415	380-400-415
	Phase		Three phase	Three phase	Three phase	Three phase	Three phase	Three phase	Three phase	Three phase
	Frequency	Hz	50	50	50	50	50	50	50	50
Cooling capacity	kW		96,0	101,0	107,0	113,0	118,0	124,0	130,0	135,0
EER <sup>1)</sup>	W/W		4,10	3,90	3,88	3,72	3,72	3,58	3,55	3,49
Current	A		38,60-36,70-35,40	42,30-40,20-38,70	45,60-43,30-41,70	50,20-47,70-46,00	52,40-49,70-47,90	56,50-53,70-51,80	61,10-58,10-56,00	63,90-60,70-58,50
Input power	kW		23,40	25,90	27,60	30,40	31,70	34,60	36,60	38,70
Heating capacity	kW		108,0	113,0	119,0	127,0	132,0	138,0	145,0	150,0
COP <sup>1)</sup>	W/W		4,64	4,48	4,51	4,31	4,36	4,25	4,18	4,17
Current	A		38,90-37,00-35,60	41,60-39,50-38,10	43,60-41,40-39,90	49,30-46,80-45,10	50,60-48,10-46,30	53,70-51,00-49,10	57,90-55,00-53,00	60,10-57,10-55,00
Input power	kW		23,30	25,20	26,40	29,50	30,30	32,50	34,70	36,00
Starting current	A		4,00	4,00	4,00	5,00	5,00	5,00	6,00	6,00
External static pressure (Max)	Pa		80	80	80	80	80	80	80	80
Air flow	m <sup>3</sup> /min		662	674	684	674	684	696	696	696
Sound pressure	Normal mode	dB(A)	64,0	64,5	65,0	65,5	66,0	66,5	66,5	67,0
	Silent mode 1 / 2	dB(A)	61,0/59,0	61,5/59,5	62,0/60,0	62,5/60,5	63,0/61,0	63,5/61,5	63,5/61,5	64,0/62,0
Sound power	Normal mode	dB(A)	84,5	85,5	85,5	85,5	86,0	86,5	87,0	87,0
Dimension	HxWxD	mm	1842 x 3540 (+120) x 1000	1842 x 3540 (+120) x 1000	1842 x 3540 (+120) x 1000	1842 x 3540 (+120) x 1000	1842 x 3540 (+120) x 1000	1842 x 3540 (+120) x 1000	1842 x 3540 (+120) x 1000	1842 x 3540 (+120) x 1000
Net weight	kg		857	881	882	929	930	954	1002	1002
Piping diameter <sup>2)</sup>	Liquid	Inch (mm)	3/4 (19,05) / 7/8 (22,22)	3/4 (19,05) / 7/8 (22,22)	3/4 (19,05) / 7/8 (22,22)	3/4 (19,05) / 7/8 (22,22)	3/4 (19,05) / 7/8 (22,22)	3/4 (19,05) / 7/8 (22,22)	3/4 (19,05) / 7/8 (22,22)	3/4 (19,05) / 7/8 (22,22)
	Discharge	Inch (mm)	1-1/8 (28,58) / 1-1/4 (31,75)	1-1/8 (28,58) / 1-1/4 (31,75)	1-1/4 (31,75) / 1-1/2 (38,10)	1-1/4 (31,75) / 1-1/2 (38,10)	1-1/4 (31,75) / 1-1/2 (38,10)	1-1/2 (38,10) / 1-1/2 (38,10)	1-1/4 (31,75) / 1-1/2 (38,10)	1-1/4 (31,75) / 1-1/2 (38,10)
	Suction	Inch (mm)	1-1/4 (31,75) / 1-1/2 (38,10)	1-1/2 (38,10) / 1-5/8 (41,28)	1-1/2 (38,10) / 1-5/8 (41,28)	1-1/2 (38,10) / 1-5/8 (41,28)	1-1/2 (38,10) / 1-5/8 (41,28)	1-1/2 (38,10) / 1-5/8 (41,28)	1-1/2 (38,10) / 1-5/8 (41,28)	1-1/2 (38,10) / 1-5/8 (41,28)
	Balance	Inch (mm)	1/4 (6,35)	1/4 (6,35)	1/4 (6,35)	1/4 (6,35)	1/4 (6,35)	1/4 (6,35)	1/4 (6,35)	1/4 (6,35)
Refrigerant (R410A) / CO <sub>2</sub> Eq.	kg / T		21,90/45,72719	23,40/48,85919	23,40/48,85919	23,40/48,85919	23,40/48,85919	24,90/46,3536	24,90/51,9912	24,90/51,9912
Maximum allowable indoor / outdoor capacity ratio	%		50 ~ 150	50 ~ 150	50 ~ 150	50 ~ 150	50 ~ 150	50 ~ 150	50 ~ 150	50 ~ 150
Operating range	Cool Min ~ Max	°C	-10 ~ +52	-10 ~ +52	-10 ~ +52	-10 ~ +52	-10 ~ +52	-10 ~ +52	-10 ~ +52	-10 ~ +52
	Heat Min ~ Max	°C	-20 ~ +18	-20 ~ +18	-20 ~ +18	-20 ~ +18	-20 ~ +18	-20 ~ +18	-20 ~ +18	-20 ~ +18
	Simultaneous op.	°C	-10 ~ +24	-10 ~ +24	-10 ~ +24	-10 ~ +24	-10 ~ +24	-10 ~ +24	-10 ~ +24	-10 ~ +24

1) EER and COP calculation is based in accordance to EN 14511. 2) Piping diameter under 90 m for ultimate indoor unit / over 90 m for ultimate indoor unit (if the longest piping equivalent length exceeds 90 m, increase the sizes of the main tubes by 1 rank for gas tubes and liquid tubes).

## ECO G, the gas driven VRF

**ECO G**

The advanced Gas Driven VRF system offers increased efficiency and performance across the range. Improvements include increased part load performance, reduced gas consumption with a Miller-cycle engine and reduced electrical consumption by using DC-Fan motors.



### 2-Pipe ECO G GE3 Series R410A.

Designed for better energy efficiency.



### 3-Pipe ECO G GF3 Series R410A.

Domestic hot water can be supplied by effectively using waste heat generated during heating and cooling operation.



#### 1 Limited electric supply

Electric consumption of ECO G is only 9% compared to ECOi because gas engine is utilized for the compressor driving force.

#### 2 High demand of DHW with heating and cooling cogeneration

DHW is produced effectively thanks to heat from engine exhaust during heating and cooling.

#### 3 Open and flexible design

ECO G system is designed to connect various Indoor units and controllers which are available for ECOi systems. With GE3 series, Pump Down system has been implemented to answer commercial needs.

#### 4 Quick start up in heating at low ambient temperature

Gas heat pump systems make your building comfortably warm with a quick start by using waste heat from engine. Heating mode works from an ambient temperature of -21 °C.

Comparison of heating capacity.

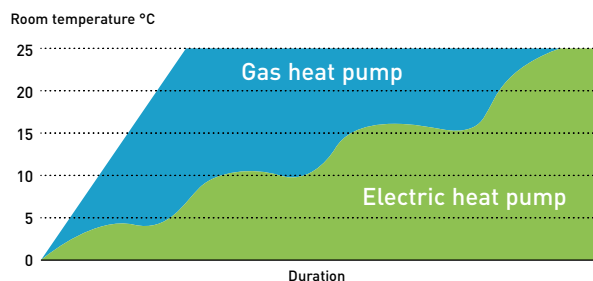

### GE3/GF3 connectable indoor units

Type	Model number reference	2-Pipe ECO G GE3 Series	3-Pipe ECO G GF3 Series
Standard A2A indoor units	—	Yes <sup>1)</sup>	Yes <sup>1)</sup>
Water heat exchanger	PAW-250/500W(P)5G	Yes <sup>2)</sup>	No
High static pressure hide-away	S-ME2E5	Yes	No
Air curtain with DX coil	PAW-EAIRC-HS/LS	Yes	Yes <sup>3)</sup>
AHU connection kit	PAW-MAH3M	Yes	Yes <sup>3)</sup>

1) Except for 1,5 kW capacity. 2) Allowed 1:1 and also mixed. If mixed, not operate at the same time WHE + DX only operate separately. 3) Smaller capacity than 16 kW only.

# ECO G, the gas driven VRF

ECO G satisfies special requirements for your application and offers an environmentally friendly solution with Panasonic professional technology, providing reliable quality given its long development history, since 1985.

Our ECO G VRF range of commercial systems is leading the industry in the development of efficient and flexible systems.

200.000

GHP outdoor units sold all over the world



1985

Introduces first GHP (Gas Heat Pump) VRF air conditioner.

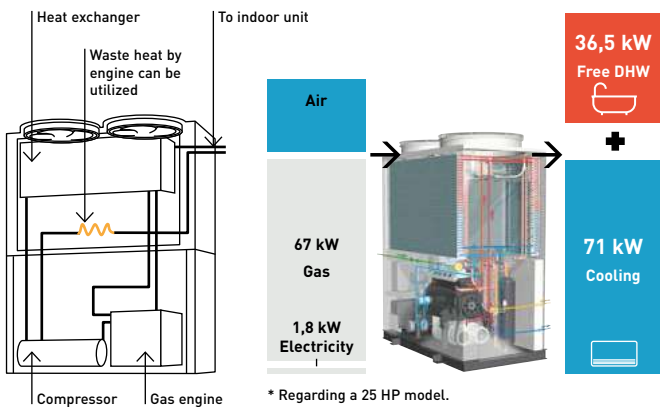

## What is GHP? The Gas Heat Pump (GHP)

Panasonic Gas Heat Pump is a direct expansion system, with a compressor the same as the VRF system. A Gas engine is used as the driving force of the compressor instead of an electric motor. This gas engine compressor drive has 2 advantages:

- 1 | Waste heat available from the gas engine.
- 2 | No need for motor power consumption thanks to gas engine.

GHP is the natural choice for commercial projects, especially for those projects where electrical power restrictions apply.

## Power supply problems?

If you are short of electric power, our ECO G is a perfect solution.

- Runs on natural gas or LPG and just needs single phase supply
- Enables the building's electrical power supply to be used for other critical electrical demands
- Reduces capital cost to upgrade power substations to run heating and cooling systems
- Reduces power loadings within a building especially during peak periods
- Electricity supply freed up for other uses such as IT servers, commercial refrigeration, manufacturing, lighting, etc...

## Limited electricity area.

Comparison of electrical consumption on a 71 kW outdoor unit.

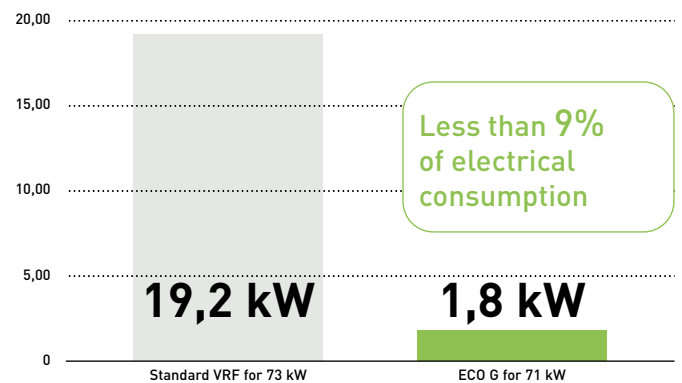

## Application example: Hotel.

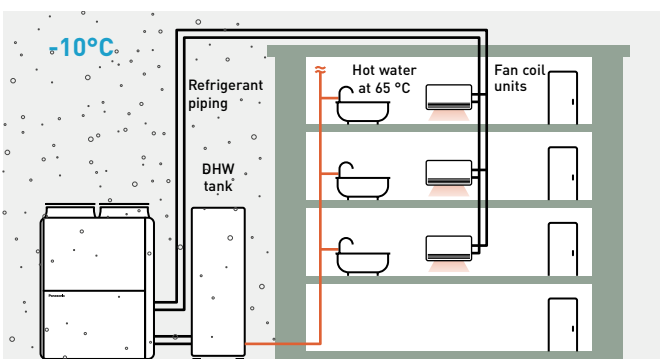

No need additional electric heaters. \* This scheme is also valid with WHE.

## High demand of domestic hot water in heating and cooling

The rejected heat from the engine is available for DHW production and can supply up to 46 kW of hot water at 65 °C. DHW at 65 °C is also ready to use in heating without additional electric heaters.



**Quick start up and great heating capacity at low ambient temperature.**

Waste heat from gas engine is utilized to raise temperature faster than electric VRF systems. This contributes great heating capacity at extremely low ambient temperature.

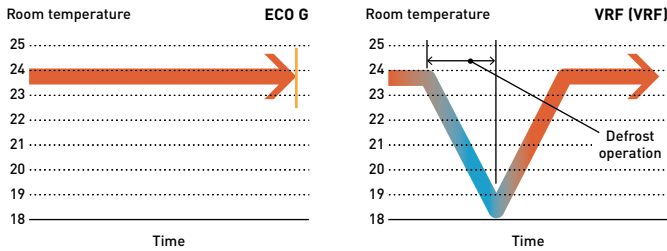

**Lowest nitrogen oxide emissions.**

The ECO G VRF systems have low nitrogen oxide emissions. In a pioneering development, the Panasonic ECO G features a brand lean-burn combustion system that utilizes air fuel ratio feedback control to reduce NOx emissions to an all time low.

**Water chiller option.**

Our ECO G system is also available with a water heat exchanger option, which can be combined with individual outdoor units or as part of a DX chilled water mix of indoor units. The system can be operated via a BMS system or a Panasonic supplied control panel, with chilled water set points from -15 °C ~ +15 °C and heating set points 35 °C ~ +55 °C.

**Application**

Application	Condition	ECO G
Hotel	High DHW demand	✓ Energy recovery of ECO G system can fulfill different requirement
Hotel	Needs to warm up swimming pool	✓
Office	Quick start up is necessary	✓ Speed of start up is quicker than VRF system
Winery	1) Outlet water demand at specific temperature 2) Needs high amount of power temporary (not every month)	✓ 1) Chiller application with hydro module (ECO G + WHE) can make this special process 2) Running cost can be saved since fixed Gas tariff per month is cheaper than fixed electric tariff.
Any building	In a city with power restriction	✓ - No need an additional power transformer - Space and cost can be saved
	At extremely low ambient condition	✓ Heating capacity is kept up to -20 °C without defrost process

**Project case studies**



**Savills HQ Dublin and Google Block R. Ireland.**  
ECO G 3-Pipe units with a 243 kW load.  
The project has been such a success that it has recently been awarded a Panasonic PRO Award for Best Contribution of efficient projects within Europe.



**Thomas Cook's Sunprime Atlantic View resort.**  
A holiday resort in the Canaries. Spain.  
229 rooms plus full spa and swimming pool facility.



**CAPITA call centre. UK.**  
11 ECO G 3-Pipe units.  
Over 150 indoor units in meeting rooms and open-plan areas.  
Intelligent touch screen controller, the CZ-256ESMC2.



**French winery Gennevilliers, France.**  
ECO G 3-Pipe units. One of the best solution utilized our ECO G solution for wine production process.

# ECO G 3 Series R410A

Introducing ECO G 3 Series. Optimised energy saving with reliable Panasonic technologies.

## Improvement in blast efficiency

### 3-blades fan.

Propeller shape with 3 blades is more efficient  
Max. 30% of fan electrical consumption is saved compared to conventional fan.

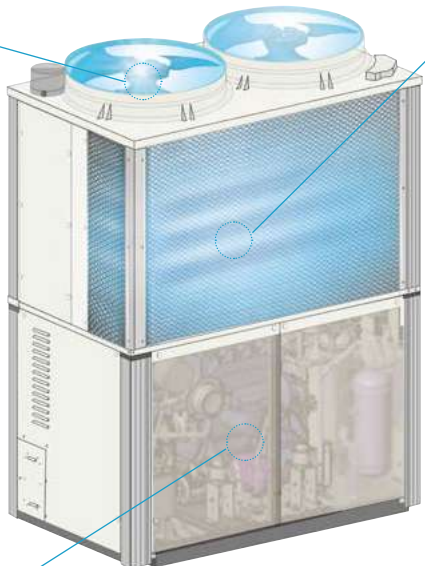
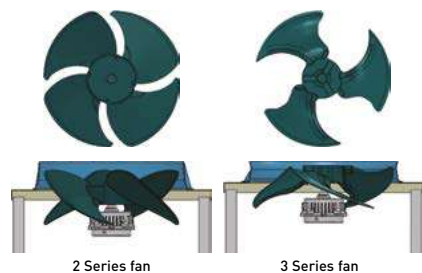

## "L" type heat exchanger

Heat exchanger surface area is increased by 25% compared to previous model to optimise efficiency.

Heat exchanger surface area 25% up

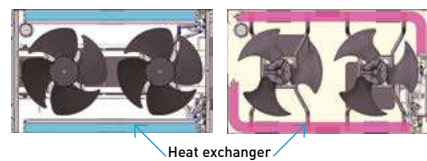

## Better partial load control

Start / stop loss reduced by expanding the area where continuous operation is possible. Annual operation efficiency has further improved due to better efficiency at lower partial load.

## Compressor.

- Amount of internal leakage is reduced due to reduction of clearances, the compressor efficiency in low load and low rotation region has been greatly improved. Moreover, efficiency of high speed and high load is also improved due to expansion of suction path resulting in reduction of suction pressure
- Optimise compressor capacity

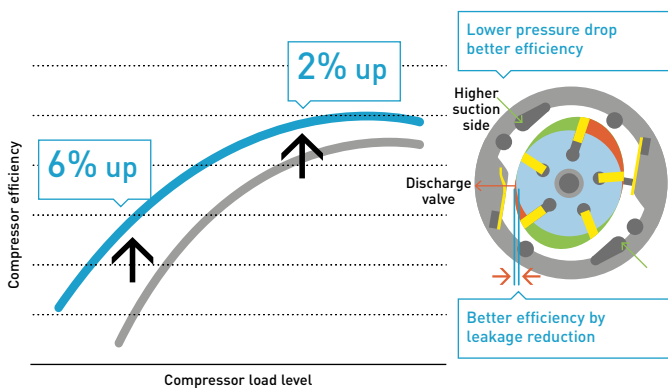

## Engine.

- Continuous operation area widened at lower partial load by expanding operation area of lower speed
- Engine efficiency has improved by shifting output points to higher torque side

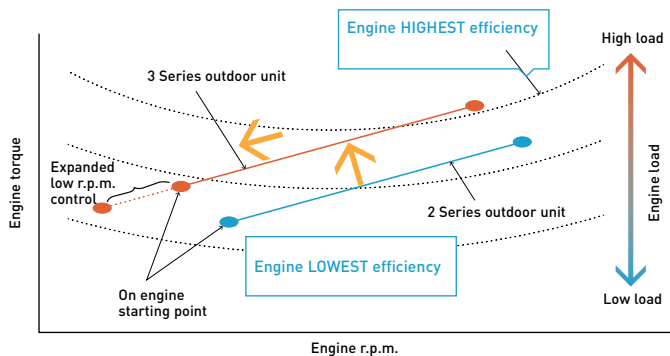

## Engine pulley.

- Larger diameter engine pulley contributes to optimisation of compressor rotation speed ratio. Increased engine pulley diameter provides better performance at partial load, reducing ON / OFF operation.

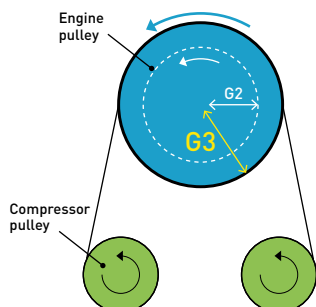

## Line up of GE3 2-Pipe W-Multi.

- For new or renewal
- Available for water heat exchanger
- Maximum 60 HP combination



The highest seasonal performance in all capacity ranges.

High power efficiency of W-Multi system.

ECO G 3 Series system offers seasonal efficiency which has been drastically improved with the heat exchanger design, blast efficiency, partial load control.

Compared to previous model ECO G 2 Series.

All models have maximum 25% of SEER, 15% of SCOP improvement compared to previous model.

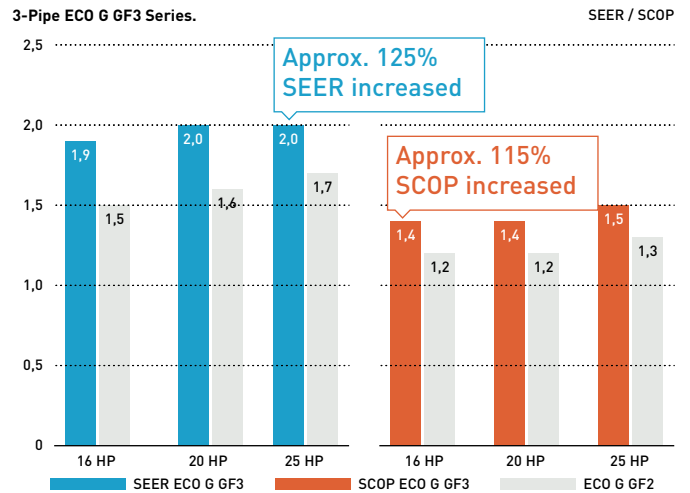
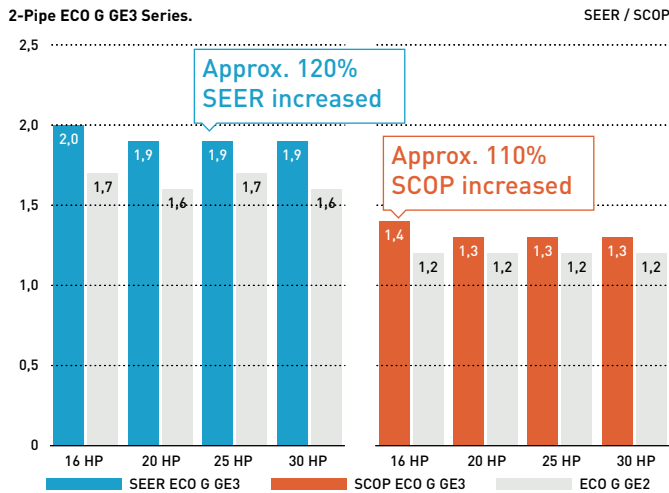

\* Comparison under Panasonic condition follows EN14825.

Heating design operation conditions (GE3)

Operating range in heating has been expanded up to 24 °C (WB) for air to water use, to meet the demand of swimming pool applications.

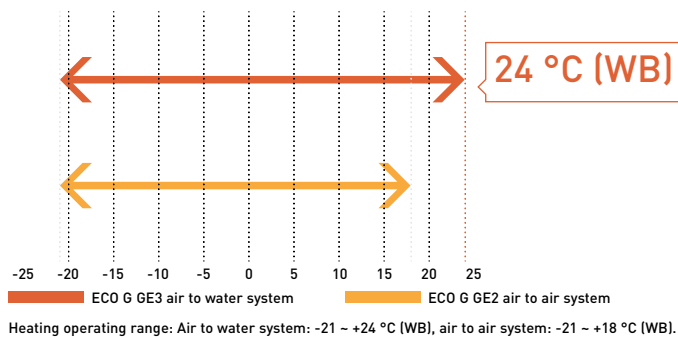

DHW priority mode setting in heating (GE3)

Ambient temperature range for DHW production is expandable by setting depending on DHW needs. Hot water at 65 °C is available in heating without additional electric heaters.

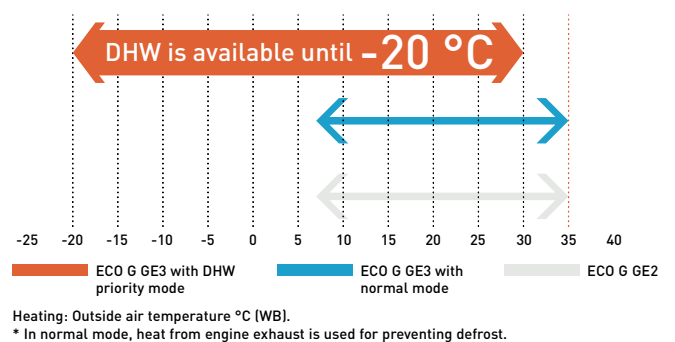

No defrost requirement (GE3 / GF3)

No defrost mode is selectable to get higher capacity at low ambient temperature.

Flexible design with wide line up of indoor units

The advanced GE3 Series can connect up to 64 indoor units.

Series	16 HP	20 HP	25 HP	30 HP	32 HP	36 HP	40 HP	45 HP	50 HP	55 HP	60 HP
2-Pipe ECO G GE3 Series	26	33	41	50	52	59	64	64	64	64	64
3-Pipe ECO G GF3 Series	24	24	24	—	—	—	—	—	—	—	—

## 2-Pipe ECO G GE3 Series · R410A

The GE3 Series has top level seasonal efficiency in this category. In addition, this product fits with special needs for commercial application thanks to DHW priority setting and auto Pump Down functions.

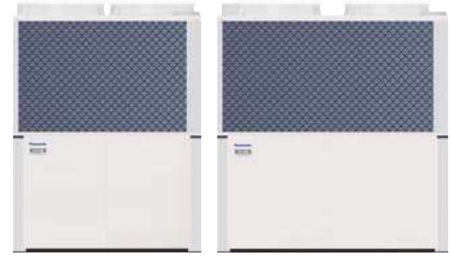

HP			16 HP	20 HP	25 HP	30 HP
Outdoor unit			U-16GE3E5	U-20GE3E5	U-25GE3E5	U-30GE3E5
Power supply	Voltage	V	220 - 230 - 240	220 - 230 - 240	220 - 230 - 240	220 - 230 - 240
	Phase		Single phase	Single phase	Single phase	Single phase
	Frequency	Hz	50	50	50	50
Cooling capacity		kW	45,0	56,0	71,0	85,0
Refrigeration load Pdesign <sup>1)</sup>		kW	45,0	56,0	71,0	85,0
$\eta_{s,c}$ (LOT21) <sup>1)</sup>			<b>220,6%</b>	<b>219,3%</b>	<b>240,1%</b>	<b>229,3%</b>
Input power		kW	1,17	1,12	1,80	1,80
Hot water in cooling mode (at 65 °C outlet)		kW	23,60	29,10	36,40	46,00
Max COP in hot water		W/W	1,55	1,55	1,49	1,47
Gas consumption cooling		kW	41,10	52,10	67,20	84,10
Heating capacity	Standard	kW	50,0	63,0	80,0	95,0
	Low temperature	kW	53,0	67,0	78,0	90,0
Refrigeration load Pdesign <sup>1)</sup>		kW	37,0	53,0	60,0	65,0
$\eta_{s,h}$ (LOT21) <sup>1)</sup>			<b>150,6%</b>	<b>143,7%</b>	<b>146,9%</b>	<b>151,3%</b>
Input power		kW	0,56	1,05	0,91	1,75
Gas consumption heating	Standard	kW	38,00	51,10	68,60	75,30
	Low temperature	kW	45,40	62,70	60,70	73,90
Starter amperes		A	30	30	30	30
External static pressure		Pa	10	10	10	10
Air flow		m <sup>3</sup> /min	370	420	460	460
Sound power	Normal	dB(A)	80	80	84	84
	Silent mode	dB(A)	77	77	81	81
Dimension	H x W x D	mm	2255 x 1650 x 1000	2255 x 1650 x 1000	2255 x 2026 x 1000	2255 x 2026 x 1000
Net weight		kg	765	765	870	880
Piping diameter	Liquid	Inch (mm)	1/2 (12,70)	5/8 (15,88)	5/8 (15,88)	3/4 (19,05)
	Gas	Inch (mm)	1-1/8 (28,58)	1-1/8 (28,58)	1-1/8 (28,58)	1-1/4 (31,75)
	Fuel gas	Inch (mm)	3/4 (19,05)	3/4 (19,05)	3/4 (19,05)	3/4 (19,05)
	Exhaust drain port	mm	25	25	25	25
	Hot water supply in/out		Rp% (Nut, thread)	Rp% (Nut, thread)	Rp% (Nut, thread)	Rp% (Nut, thread)
Elevation difference (in / out)			50	50	50	50
Refrigerant (R410A) / CO <sub>2</sub> Eq.		kg / T	11,50 / 24,00	11,50 / 24,00	11,50 / 24,00	11,50 / 24,00
Maximum number of connectable indoor units			26	33	41	50
Operating range	Cool Min ~ Max	°C (DB)	-10 ~ +43	-10 ~ +43	-10 ~ +43	-10 ~ +43
	Heat Min ~ Max	°C (WB)	-21 ~ +18	-21 ~ +18	-21 ~ +18	-21 ~ +18

1) ErP test data.

Hot water take out function added, EU safety regulation standard cleared. 25 HP chassis enlarged due to specification improvement. Pre-coat corrosion fin. Auto Pump Down function.

## Technical focus

- Superior seasonal energy efficiency, maximum 240,1%
- DHW priority setting
- Operating range in heating down to -21 °C and up to +24 °C for air to water system
- No defrost cycle

- Capacity ratio 50 ~ 200% <sup>1)</sup>
- Option of DX or chilled water for indoor heat exchange
- Maximum total piping length: 780 m

1) 50 ~ 200% only when one outdoor unit is installed. In other cases 50 ~ 130%.

## 2-Pipe ECO G GE3 Series R410A combination from 32 to 60 HP

The GE3 Series has top level seasonal efficiency in this category. In addition, this product fits with special needs for commercial application thanks to DHW priority setting and Auto Pump Down functions.



HP			32 HP	36 HP	40 HP	45 HP	50 HP	55 HP	60 HP
Outdoor unit			U-16GE3E5	U-16GE3E5	U-20GE3E5	U-20GE3E5	U-25GE3E5	U-25GE3E5	U-30GE3E5
			U-16GE3E5	U-20GE3E5	U-20GE3E5	U-25GE3E5	U-25GE3E5	U-30GE3E5	U-30GE3E5
Power supply	Voltage	V	220-230-240	220-230-240	220-230-240	220-230-240	220-230-240	220-230-240	220-230-240
	Phase		Single phase	Single phase	Single phase	Single phase	Single phase	Single phase	Single phase
	Frequency	Hz	50	50	50	50	50	50	50
Cooling capacity		kW	90,0	101,0	112,0	127,0	142,0	156,0	170,0
Input power		kW	2,34	2,29	2,24	2,92	3,60	3,60	3,60
Hot water in cooling mode (at 65 °C outlet)		kW	47,20	52,70	58,20	65,50	72,80	82,40	92,00
Max COP in hot water		W/W	1,55	1,55	1,55	1,52	1,49	1,48	1,47
Gas consumption cooling		kW	82,20	93,20	104,20	119,30	134,40	151,30	168,20
Heating capacity	Standard	kW	100,0	113,0	126,0	143,0	160,0	175,0	190,0
	Low temperature	kW	106,0	120,0	134,0	145,0	156,0	168,0	180,0
Input power		kW	1,12	1,61	2,10	1,96	1,82	2,66	3,50
Gas consumption heating	Standard	kW	76,00	89,10	102,20	119,70	137,20	143,90	150,60
	Low temperature	kW	90,80	108,10	125,40	123,40	121,40	134,60	147,80
Starter amperes		A	30	30	30	30	30	30	30
External static pressure		Pa	10	10	10	10	10	10	10
Air flow		m <sup>3</sup> /min	370/370	370/420	420/420	420/460	460/460	460/460	460/460
Sound power	Normal	dB(A)	83	83	83	86	87	87	87
	Silent mode	dB(A)	80	80	80	83	84	84	84
Dimension	Height	mm	2255	2255	2255	2255	2255	2255	2255
	Width	mm	1650+100 +1650	1650+100 +1650	1650+100 +1650	1650+100 +2026	2026+100 +2026	2026+100 +2026	2026+100 +2026
	Depth	mm	1000	1000	1000	1000	1000	1000	1000
Net weight		kg	1530(765+765)	1530(765+765)	1530(765+765)	1635(765+870)	1740(870+870)	1750(870+880)	1760(880+880)
	Liquid	Inch (mm)	3/4(19,05)	3/4(19,05)	3/4(19,05)	3/4(19,05)	3/4(19,05)	7/8(22,22)	7/8(22,22)
Piping diameter	Gas	Inch (mm)	1-1/4(31,75)	1-1/4(31,75)	1-1/2(38,10)	1-1/2(38,10)	1-1/2(38,10)	1-1/2(38,10)	1-1/2(38,10)
	Fuel gas	Inch (mm)	3/4(19,05)	3/4(19,05)	3/4(19,05)	3/4(19,05)	3/4(19,05)	3/4(19,05)	3/4(19,05)
	Exhaust drain port	mm	25	25	25	25	25	25	25
	Hot water supply in/out		Rp% (Nut, thread)	Rp% (Nut, thread)	Rp% (Nut, thread)	Rp% (Nut, thread)	Rp% (Nut, thread)	Rp% (Nut, thread)	Rp% (Nut, thread)
Elevation difference (in / out)			50	50	50	50	50	50	50
Refrigerant (R410A) / CO <sub>2</sub> Eq.		kg / T	2x11,50/24,00	2x11,50/24,00	2x11,50/24,00	2x11,50/24,00	2x11,50/24,00	2x11,50/24,00	2x11,50/24,00
Maximum number of connectable indoor units			52	59	64	64	64	64	64
Operating range	Cool Min ~ Max	°C	-10 ~ +43	-10 ~ +43	-10 ~ +43	-10 ~ +43	-10 ~ +43	-10 ~ +43	-10 ~ +43
	Heat Min ~ Max	°C	-21 ~ +18	-21 ~ +18	-21 ~ +18	-21 ~ +18	-21 ~ +18	-21 ~ +18	-21 ~ +18

Data is for reference. Hot water take out function added, EU safety regulation standard cleared. 25 HP chassis enlarged due to specification improvement. Pre-coat corrosion fin. Auto Pump Down function.

### Technical focus

- Maximum 60 HP combination
- Superior seasonal energy efficiency, maximum 240,1%
- DHW priority setting
- Operating range in heating down to -21 °C and up to +24 °C for air to water system
- No defrost cycle
- Option of DX or chilled water for indoor heat exchange
- Maximum total piping length: 780 m



# 3-Pipe ECO G GF3 Series R410A

## Excellent performance and free domestic hot water

Panasonic 3-Pipe Multi system is capable of simultaneous heating / cooling and individual operation of each indoor unit by only one outdoor unit. As a result, efficient individual air conditioning is possible in buildings having diverse room temperatures. In addition, domestic hot water is created for free in cooling mode, without additional boilers or electric heaters.

### System example.

Improved maintenance intervals. The unit only needs to be serviced every 10000 hours.

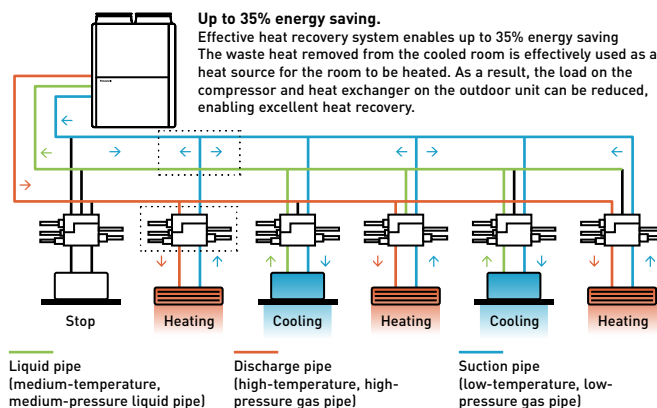

**3-Pipe control solenoid valve kit.**

<b>KIT-P56HR3</b> (CZ-P56HR3 + CZ-CAPE2).	<b>KIT-P160HR3</b> (CZ-P160HR3 + CZ-CAPE2).
<b>CZ-P56HR3</b> Up to 5,6 kW.	<b>CZ-P160HR3</b> Up to 16,0 kW.

**3-Pipe control PCB.**

**CZ-CAPE2\***

\* For Wall-mounted. Must be added to the CZ-P56HR3 or CZ-P160HR3.

## Solenoid valve kit

To be installed on all 'zones', allowing simultaneous heating and cooling. Up to 24 indoor units are capable of simultaneous heating / cooling operation. Oil-recovery operation gives more stable comfort air-conditioning control.

## Power supply problems?

If you are short of electrical power, our gas heat pump could be the perfect solution:

- Runs on natural gas or LPG and needs just a single phase supply
- Enables the building's electrical power supply to be used for other critical electrical demands
- Reduces capital cost to upgrade power substations to run heating and cooling systems

- Reduces power loadings within a building especially during peak periods
- Electricity supply freed up for other uses such as IT servers, commercial refrigeration, manufacturing, lighting etc.

### ECO G outdoor heat exchanger.

- Integrated DX and hot water coil
- No defrost required
- Faster reaction to demand for heating

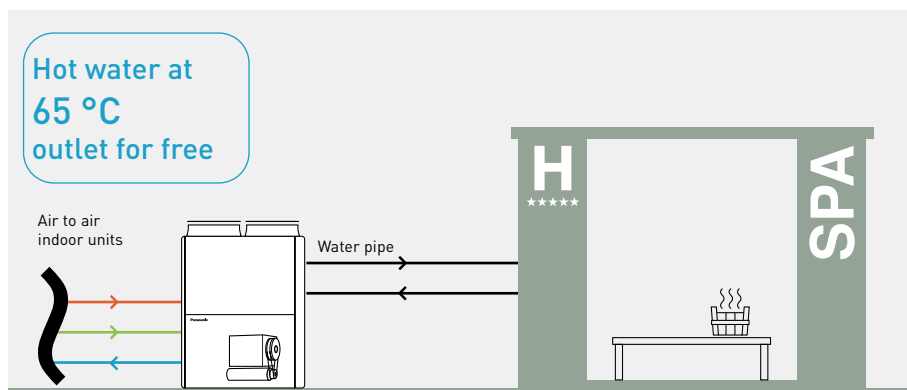
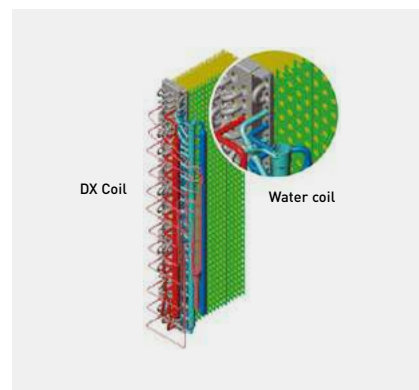

## DHW production in heating and cooling

Free DHW is available 365 days a year. Hot water is produced effectively from waste heat from the engine. Perfect solution for hotel projects requiring high demand for hot water.

HP	Free DHW (in cooling mode)
16 HP	23,6 kW
20 HP	27,1 kW
25 HP	40,5 kW

### 3-Pipe ECO G GF3 Series · R410A

#### DHW available in all seasons.

Effective production of domestic hot water from engine waste heat in both heating and cooling, all year round.



HP			16 HP	20 HP	25 HP
Outdoor unit			U-16GF3E5	U-20GF3E5	U-25GF3E5
Power supply	Voltage	V	220 - 230 - 240	220 - 230 - 240	220 - 230 - 240
	Phase		Single phase	Single phase	Single phase
	Frequency	Hz	50	50	50
Cooling capacity		kW	45,0	56,0	71,0
Refrigeration load Pdesign <sup>1)</sup>		kW	45,0	56,0	71,0
<b>η<sub>s,c</sub> (LOT21) <sup>1)</sup></b>			<b>185,2%</b>	<b>198,8%</b>	<b>204,9%</b>
Input power		kW	1,17	1,40	1,80
Hot water in cooling mode (at 65 °C outlet)		kW	23,60	27,10	40,50
Gas consumption cooling		kW	45,80	54,80	73,70
Heating capacity	Standard	kW	50,0	63,0	80,0
	Low temperature	kW	53,0	67,0	78,0
Refrigeration load Pdesign <sup>1)</sup>		kW	38,0	52,0	60,0
<b>η<sub>s,h</sub> (LOT21) <sup>1)</sup></b>			<b>139,2%</b>	<b>140,2%</b>	<b>150,9%</b>
Input power		kW	0,56	1,05	0,91
Gas consumption heating	Standard	kW	42,20	51,10	68,60
Starter amperes		A	30	30	30
Air flow		m <sup>3</sup> /min	370	400	460
Sound power	Normal	dB(A)	80	81	84
	Silent mode	dB(A)	77	78	81
Dimension	HxWxD	mm	2255 x 1650 x 1000	2255 x 1650 x 1000	2255 x 2026 x 1000
Net weight		kg	775	775	880
Piping diameter	Liquid	Inch (mm)	3/4 (19,05)	3/4 (19,05)	3/4 (19,05)
	Gas	Inch (mm)	1 1/8 (28,58)	1 1/8 (28,58)	1 1/8 (28,58)
	Discharge	Inch (mm)	7/8 (22,22)	1 (25,40)	1 (25,40)
	Fuel gas	Inch (mm)	3/4 (19,05)	3/4 (19,05)	3/4 (19,05)
	Exhaust drain port	mm	25	25	25
	Hot water supply in/out		Rp% (Nut, thread)	Rp% (Nut, thread)	Rp% (Nut, thread)
Elevation difference (in / out)		m	50	50	50
Refrigerant (R410A) / CO <sub>2</sub> Eq.		kg / T	11,50/24,00	11,50/24,00	11,50/24,00
Maximum number of connectable indoor units			24	24	24
Operating range	Cool Min ~ Max	°C	-10 ~ +43	-10 ~ +43	-10 ~ +43
	Heat Min ~ Max	°C	-21 ~ +18	-21 ~ +18	-21 ~ +18

1) ErP test data.

Hot water take out function added, EU safety regulation standard cleared. 25 HP chassis enlarged due to specification improvement. Pre-coat corrosion fin. Auto Pump Down function.

#### Solenoid valve kit

<b>KIT-P56HR3</b>	3-Pipe control solenoid valve kit (up to 5,6 kW)
<b>CZ-P56HR3</b>	Solenoid valve kit (up to 5,6 kW)
<b>CZ-CAPE2</b>	3-Pipe control PCB
<b>KIT-P160HR3</b>	3-Pipe control solenoid valve kit (from 5,6 to 16,0 kW)
<b>CZ-P160HR3</b>	Solenoid valve kit (from 5,6 kW to 16,0 kW)
<b>CZ-CAPE2</b>	3-Pipe control PCB
<b>CZ-CAPEK2 <sup>2)</sup></b>	3-Pipe control PCB for wall-mounted

#### 3-Pipe control box kit

<b>CZ-P456HR3</b>	4 ports 3 pipe box (up to 5,6 kW per port)
<b>CZ-P656HR3</b>	6 ports 3 pipe box (up to 5,6 kW per port)
<b>CZ-P856HR3</b>	8 ports 3 pipe box (up to 5,6 kW per port)
<b>CZ-P4160HR3</b>	4 ports 3 pipe box (up to 16,0 kW per port)

2) Available for S-45/56/73/106MK3E.

#### Outstanding seasonal energy efficiency, maximum 204,9%

- Capacity ratio 50 ~ 200%
- No defrost cycle
- Maximum total piping length: 780 m

#### Flexible installation

- Full heating capacity down to -21 °C (WB)
- DHW production for all the year
- Connection of up to 24 indoor units



# Panasonic GHP/EHP Hybrid System R410A. First intelligent technology

Taking advantage of Gas and Electricity to achieve better energy savings.

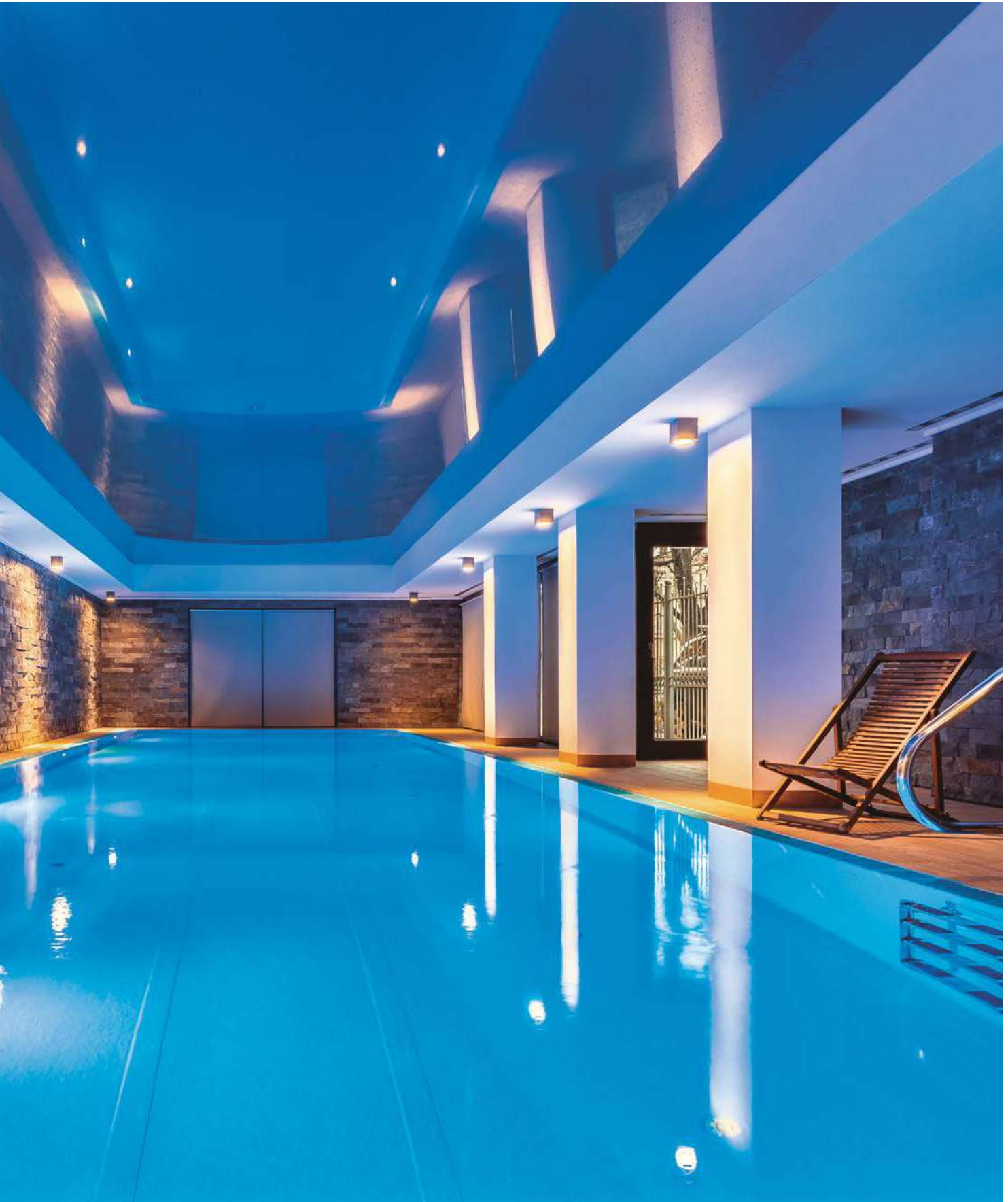
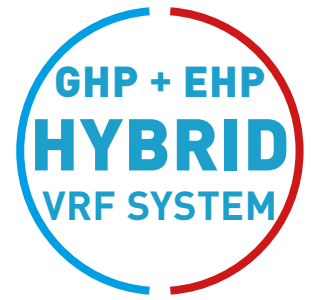



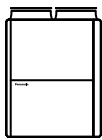
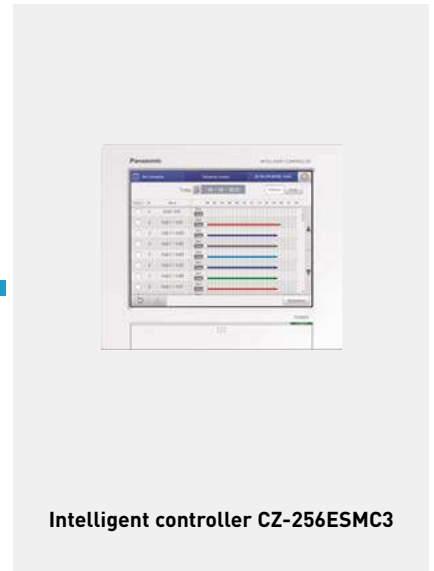
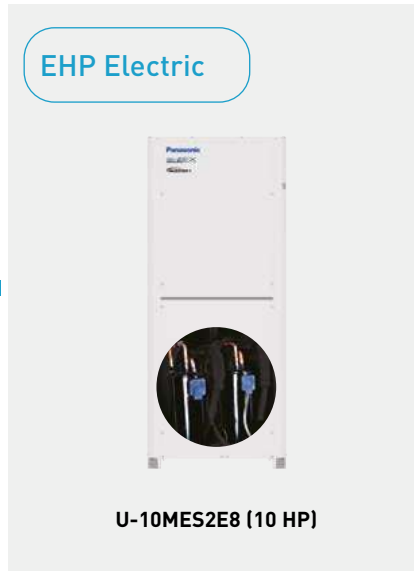
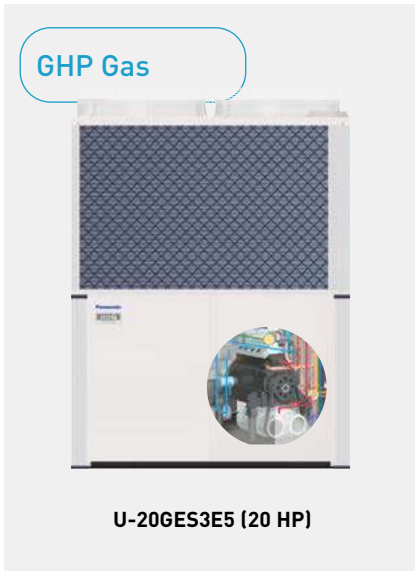

**Master unit GHP**

- Load calculation of GHP and EHP
- Operation in accordance with the upper limit setting
- Individual capacity control
- Device control
- Special control (Defrost, Oil recovery, 4 Way-valve matching / Abnormality processing)



**Slave Unit EHP**



**Intelligent controller**

- Demand monitoring
- Indoor / total load calculation
- Operation Ratio Indication
- upper limit setting of MAP according to:
  - Energy unit RRP
  - Electric power demand
  - Air conditioning load

**Schematic of GHP/EHP Hybrid System.**

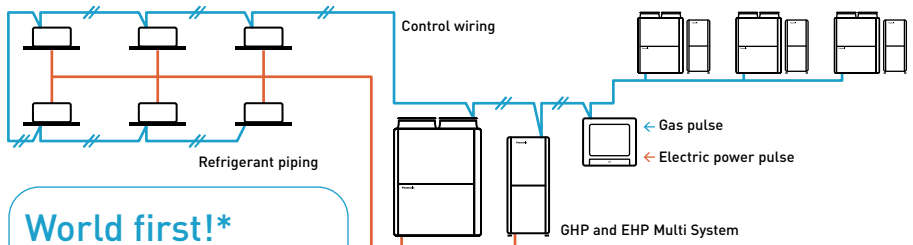

**World first!\***  
Unified refrigerant cycle in GHP and EHP

\* Introduced as a world first technology by Panasonic in April 2016.

**1 Peak cut of electricity consumption**

Electrical peak demand is significantly reduced thanks to GHP system consuming less than 10% of electricity of EHP system.

\* Image of Hotel project.

**Electric power usage.**

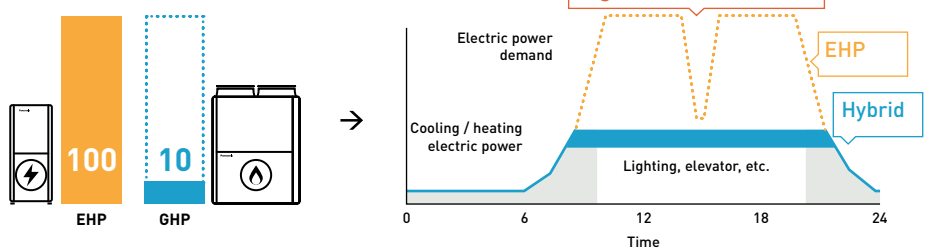

**2 Optimal control to maximize energy saving**

Switching the operation between GHP and EHP system on the basis of usage, energy demand, part load.

\* Specification is tentative.

**Optional control method.**

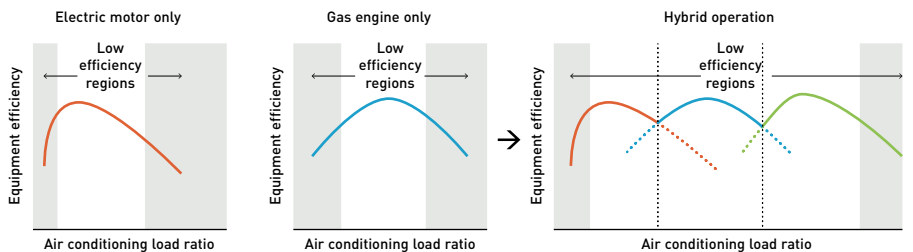

**3 Free hot water production by GHP system**

Hot water is effectively produced from waste heat of engine.

\* Specification is tentative.

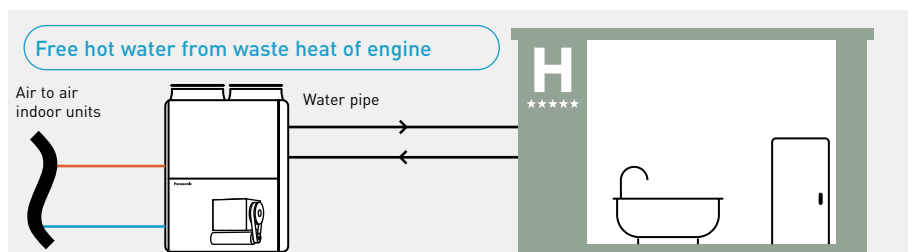

# GHP/EHP Hybrid System R410A

Panasonic's reliable ECO G / ECOi technology provides energy savings, utilising the advantages of both gas and electricity  
 The hybrid system can offer intelligent operation logic for better economy and efficiency by taking the best of ECO G. A heating and cooling system operating in a similar way to a hybrid car.



## How to smartly operate a GHP and EHP system depending on your needs

4 different mode settings are available with the intelligent controller. Switch the operation between GHP and EHP or operating both units together to maximize the effect for different requirements such as economy and efficiency.

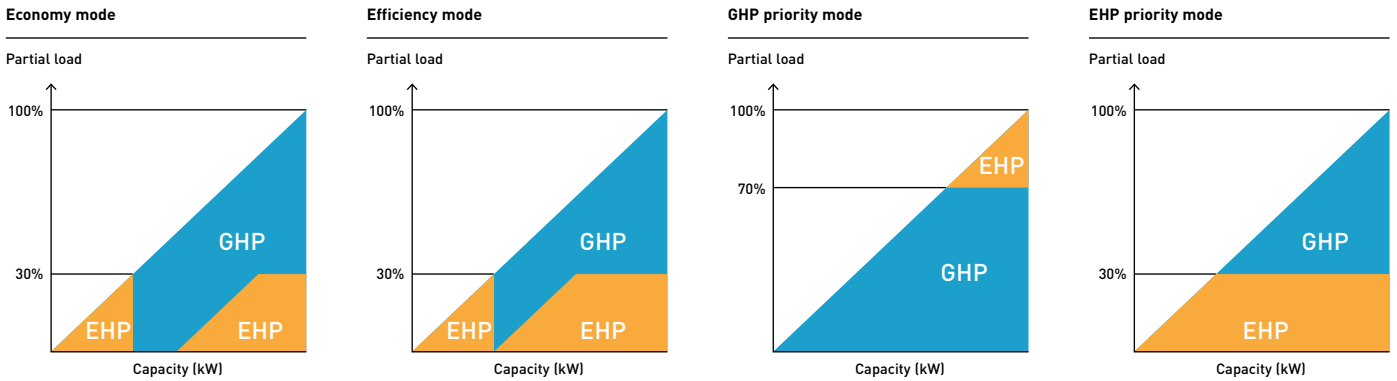

## Optimal control example: Economy mode

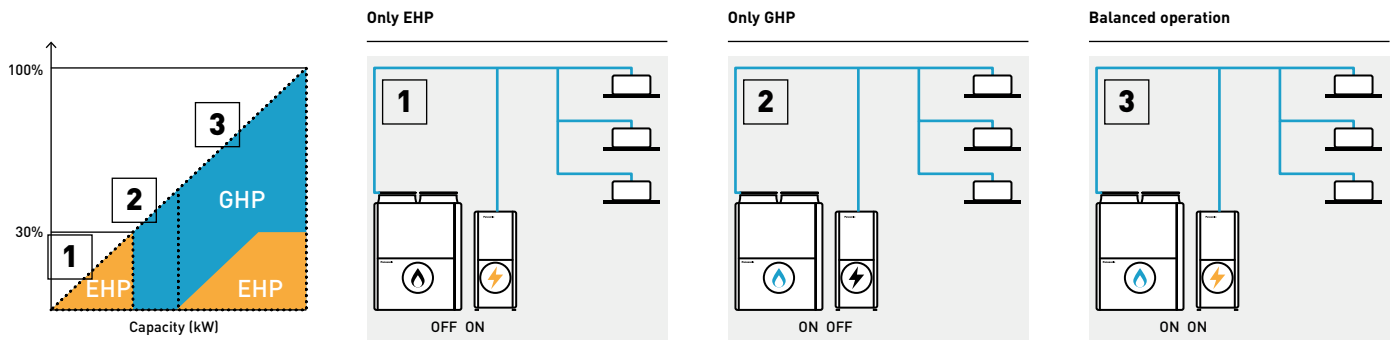

## DHW priority mode in Hybrid + WHE System

When DHW is required during cooling operation by EHP, EHP is automatically turned "OFF" and GHP is turned "ON" to produce DHW for free.

### High efficiency mode.

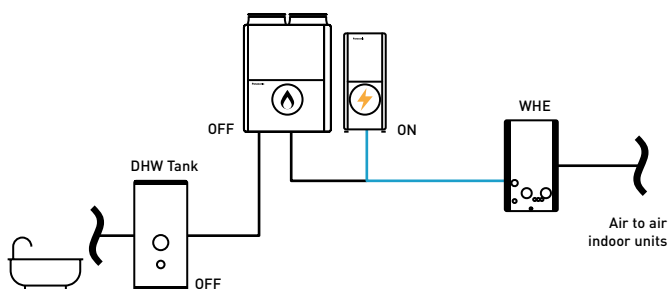

### DHW priority mode.

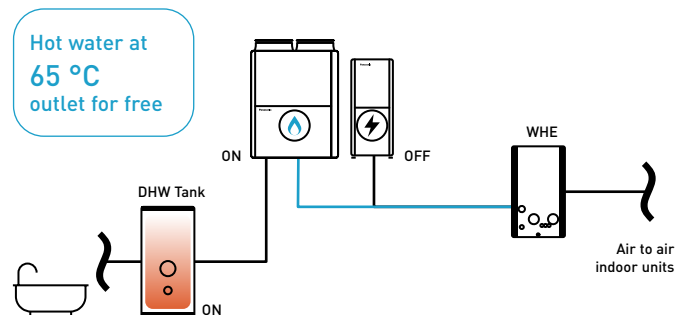

## 2-Pipe Hybrid GHP/EHP · R410A

- Extended lifespan with intelligent energy management.  
The goal is for the EHP and GHP to work at optimal speeds
- Low energy cost
- Low emissions



HP			Hybrid GHP	Hybrid EHP
Outdoor unit			20 HP	10 HP
Outdoor unit			U-20GES3E5	U-10MES2E8
Power supply	Voltage	V	220-230-240	380-400-415
	Phase		Single phase	Three phase
	Frequency	Hz	50	50
Cooling capacity		kW	56,0	28,0
<b>η<sub>s,c</sub> (LOT21)</b>			<b>211,8%</b>	<b>275,4%</b>
Current		A	5,18	10,70/10,20/9,80
Input power		kW	1,12	6,41
Hot water in cooling mode (at 65 °C outlet)		kW	26,20	—
Gas consumption cooling		kW	52,10	—
Heating capacity		kW	63,0	31,5
<b>η<sub>s,h</sub> (LOT21)</b>			<b>143,2%</b>	<b>167,6%</b>
Current		A	4,79	11,10/10,50/10,10
Input power		kW	1,05	6,62
Gas consumption heating	Standard	kW	51,10	—
Starting current		A	30	1
Air flow		m <sup>3</sup> /min	420	224
Sound pressure	Normal mode	dB(A)	58	56
Sound power	Normal mode	dB(A)	80	77
Dimension	H x W x D	mm	2255 x 1650 x 1000	1842 x 770 x 1000
Net weight		kg	765	210
Piping diameter <sup>1)</sup>	Liquid	Inch (mm)	5/8 (15,88)	3/8 (9,52)
	Gas	Inch (mm)	1 1/8 (28,58)	7/8 (22,22)
	Balance	Inch (mm)	1/4 (6,35)	1/4 (6,35)
Drain heater		W	40	—
Refrigerant (R410A) / CO <sub>2</sub> Eq.		kg / T	11,05/23,0724	5,60/11,6928
Maximum allowable indoor / outdoor capacity ratio %			50 ~ 130	50 ~ 130
Operating range	Cool Min ~ Max	°C	-10 ~ +43	-10 ~ +43
	Heat Min ~ Max	°C	-21 ~ +18	-21 ~ +18

1) Please refer service manual when the maximum piping length exceeds 90 meters (equivalent length).

### Technical focus

- 4 settings (economy, efficiency, GHP priority mode, EHP priority mode)
- DHW energy recovery 26,2 kW (at 65 °C) by engine waste heat
- Unified refrigerant cycle in GHP and EHP for easy installation
- DHW priority mode with WHE system
- Connection of up to 48 indoor units



## Water heat exchanger for hydronic applications

Panasonic water heat exchanger available with ECOi (VRF) and ECO G (gas driven VRF) systems. Those are suitable not only for new projects but also for the old chiller systems to be replaced.



### Chiller replacement. Chilled water supply to fan coils

#### Chiller replacement.

When some old chillers needed replacing at the end of their operational lifetime, ECO Gs with water heat exchangers enabled the project to be carried out in stages whilst still utilising the existing water pipe work and fan coils. This enabled the project to be delivered on time, to a restricted budget and avoided all issues regarding refrigerant in confined spaces.



Connection to 'close control' computer equipment.

Computer room applications.

When all available electrical power needed to be utilised for the IT equipment for a leading international bank, the cooling load of over 450 kW had to be powered by gas. The outdoor units were connected via water heat exchangers to cooling coils inside the 'close control' units thereby maintaining a conditioned environment for temperature and humidity. By utilising the hot water function over 100 kW of hot water are supplied to the building and therefore the additional benefit of considerable CO<sub>2</sub> savings is ensured.

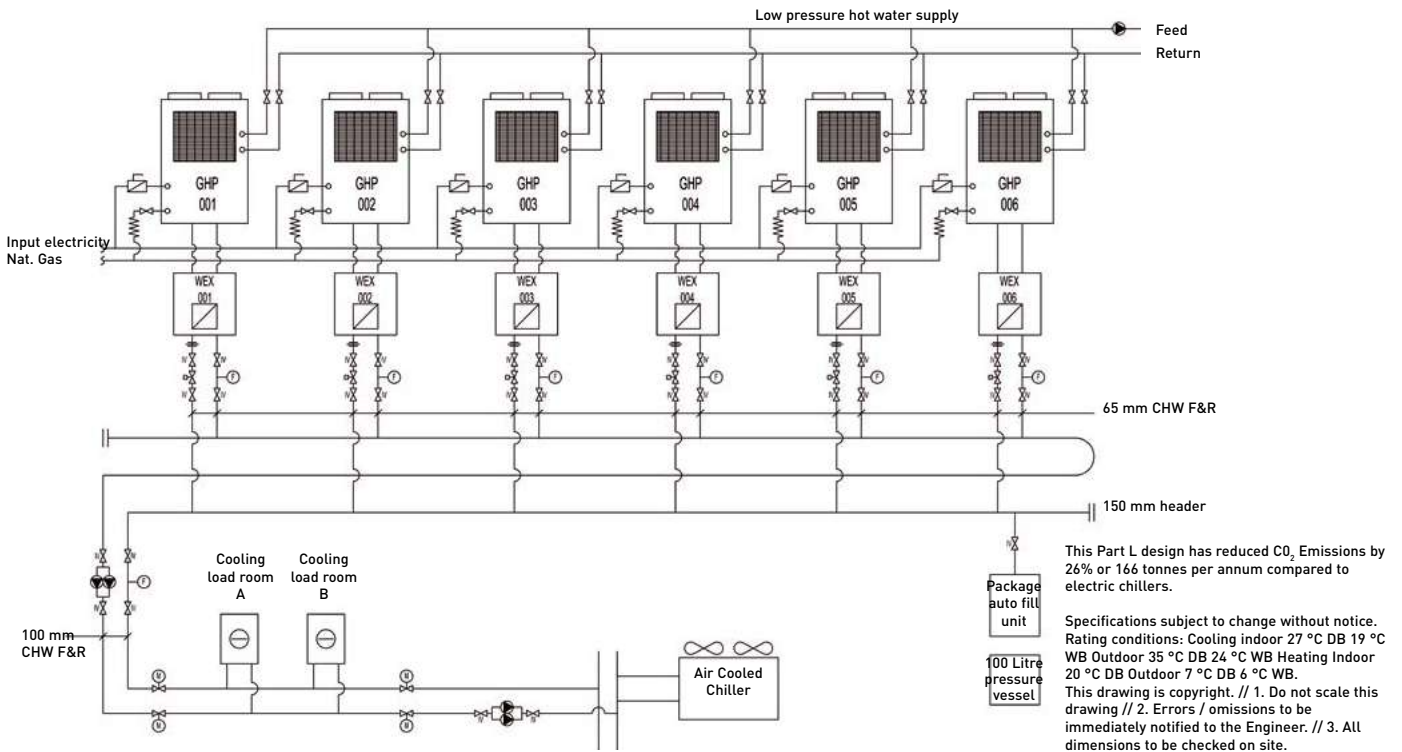

ECOi water heat exchanger

Electrical VRF with water heat exchanger  
 · With this easy to install water heat exchanger unit, you can now cover projects up to 51 kW hot water demand or 44 kW on chilled application in an efficient and cost effective way

System example.

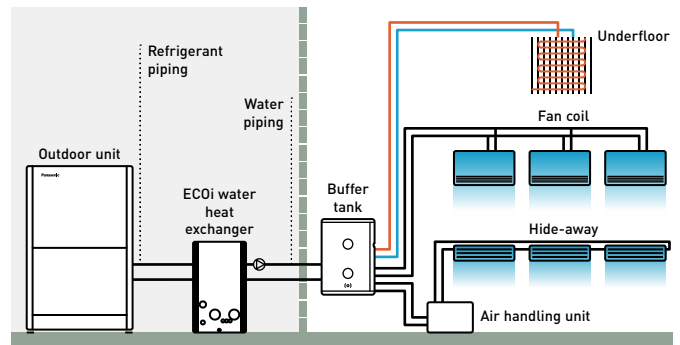

A buffer tank of minimum 280 l for 28 kW and 500 l for 50 kW is always needed.

Example of Hotel renewal of existing chiller and boiler system with Panasonic ECO G and Aquarea mixed solution

ECO G and Aquarea are the smart solution for renewal Chiller / Boiler applications with annual running cost savings around 13600€.

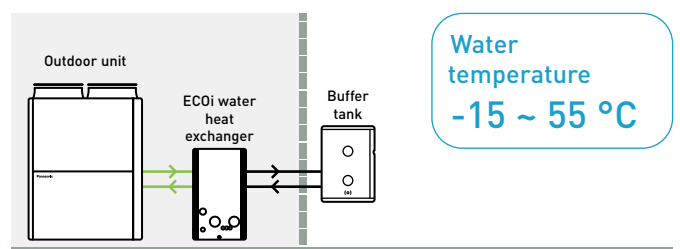

## ECOi 2-Pipe with water heat exchanger for chilled and hot water production

### Water heat exchanger (WHE) for hydronic applications.

WHE for ECOi systems controlled by a CZ-RTC5B timer remote control.

Energy-efficient capacity control with superior external static pressure is now ready.

Availability of easy vertical stacking allows installations in a limited space (up to 3 units)\*.

Stainless steel plate heat exchanger with anti-freeze protection control.

Change over between heating and cooling operation.



\* Stacking kit (PAW-3WSK) is necessary.

Hydrokit with A class water pump		PAW-250WP5G1	PAW-500WP5G1
Hydrokit without pump		PAW-250W5G1	PAW-500W5G1
Cooling capacity (A 35 °C, W 7 °C)	kW	25,0	50,0
Heating capacity	kW	28,0	56,0
Heating capacity (A +7 °C, W 45 °C)	kW	28,0	56,0
COP (A +7 °C, W 45 °C)	W/W	2,97	3,10
<b>Energy efficiency class at 35 °C <sup>1)</sup></b>		<b>A++</b>	<b>A++</b>
$\eta_{s,h}$ (LOT1) <sup>2)</sup>		<b>152,0%</b>	<b>152,0%</b>
Dimension	H x W x D	mm	1000 x 575 x 1110
Net weight		kg	135 (140 with pump)
Water pipe connector			Rp2 Female thread (50A)
Heating water flow ( $\Delta T=5$ K, 35 °C)		m <sup>3</sup> /h	5,16
Electric backup heater		kW	Not equipped
Flow switch			Equipped
Water filter			Equipped
Input power with A class water pump / without pump		kW	0,329 / 0,024
Maximum current with A class water pump / without pump		A	1,43 / 0,10
<b>Outdoor unit</b>		<b>U-10ME2E8</b>	<b>U-20ME2E8</b>
Sound pressure		dB(A)	56
Dimension	H x W x D	mm	1842 x 770 x 1000
Net weight		kg	210
Piping diameter	Liquid	Inch (mm)	3/8 (9,52)
	Gas	Inch (mm)	7/8 (22,22)
Pipe length range / Pipe length for nominal capacity		m	170 / 7,5
Elevation difference (in / out)		m	50 (OU above) 35 (OU below)
Pre-charged pipe length / Additional gas amount (R410A)		m / g/m	0 < / Refer to manual
Refrigerant (R410A) / CO <sub>2</sub> Eq.		kg	5,6 (need additional gas amount at site)
Operating range	Heat Min ~ Max	°C	-11 ~ +15 <sup>3)</sup>
Water outlet temperature range	Cool Min ~ Max	°C	+5 ~ +15
	Heat Min ~ Max	°C	+35 ~ +45

1) Unit efficiency energy level: Scale from A+++ to D. 2) Seasonal space cooling / heating energy efficiency following COMMISSION REGULATION (EU) 813/2013. 3) With accessory low temperature kit -25 ~ +15 °C. Available only as a spare part.

Performance calculation in agreement with Eurovent. Sound pressure measured at 1 m from the outdoor unit and at 1,5 m height.

### Accessories

**PAW-3WSK** Stacking kit for vertically stacking up to 3 WHE (4 pieces per Kit)

### Stacking kit PAW-3WSK.

It is possible to stack up to 3 units. When stacking units, always anchor the bottom unit to the ground using the anchor holes.

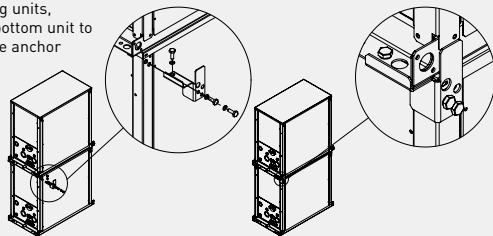

### Technical focus

- Heating, cooling and DHW
- A class water pump included (only in P model)
- Flexible modularity from 25 kW
- Better partial load vs standard chiller system
- Compatible with all centralized controllers
- Maximum distance between outdoor unit and WHE: 170 m
- Maximum hot water outlet temperature: 45 °C
- Minimum chilled water outlet temperature: 5 °C
- Outdoor temperature range in heating mode: -11 °C to +15 °C (with low temperature kit -25 °C\*)

\* Available as a spare part.

## ECO G with water heat exchanger for chilled and hot water production

### Water heat exchanger (WHE) for hydronic applications.

WHE for ECO G system controlled by a timer remote control CZ-RTC5B.

Energy-efficient capacity control is now ready.

Availability of easy vertical stacking allows installations in a limited space (up to 3 units)\*.

Stainless steel plate heat exchanger with anti-freeze protection control.

Change over between heating and cooling operation.

\* Stacking kit (PAW-3WSK) is necessary.



Hydrokit with A class water pump		PAW-500WP5G1	PAW-710WP5G1
Hydrokit without pump		PAW-500W5G1	PAW-710W5G1
Cooling capacity	kW	—	—
Cooling capacity (A +35 °C, outlet W 7 °C, inlet W 12 °C)	kW	50,0	67,0
EER (A +35 °C, outlet W 7 °C, inlet W 12 °C)	W/W	0,78	0,89
Heating capacity	kW	60,0	80,0
Heating capacity (A +7 °C, W 35 °C)	kW	60,9	81,2
COP (A +7 °C, W 35 °C)	W/W	1,15	1,18
Heating capacity (A +7 °C, W 45 °C)	kW	60,0	80,0
COP (A +7 °C, W 45 °C)	W/W	1,02	1,04
Heating capacity (A -7 °C, W 35 °C)	kW	48,2	50,8
COP (A -7 °C, W 35 °C)	W/W	0,80	0,80
Heating capacity (A -15 °C, W 35 °C)	kW	46,3	50,0
COP (A -15 °C, W 35 °C)	W/W	0,80	0,80
Refrigeration load Pdesign	kW	48,0	—
<b>Energy efficiency class at 35 °C <sup>1)</sup></b>		<b>A+</b>	<b>—</b>
<b>η<sub>s,h</sub> (LOT1) <sup>2)</sup></b>		<b>130,0%</b>	<b>128,0%</b>
Dimension	H x W x D	mm	1000 x 575 x 1110
Net weight		kg	155 (165 with pump)
Water pipe connector			Rp2 Female thread (50A)
Heating water flow (ΔT=5 K, 35 °C)		m <sup>3</sup> /h	10,32
Electric backup heater		kW	Not equipped
Flow switch			Equipped
Water filter			Equipped
Input power with A class water pump / without pump		kW	0,574 / 0,024
Maximum current with A class water pump / without pump		A	2,50 / 0,10
<b>Outdoor unit</b>			<b>U-20GE3E5</b>
Sound power	Normal / Silent	dB(A)	80 / 77
Dimension	H x W x D	mm	2255 x 1650 x 1000
Net weight		kg	765
Piping diameter	Liquid	Inch (mm)	5/8 (15,88)
	Gas	Inch (mm)	1-1/8 (28,58)
Pipe length range / Pipe length for nominal capacity		m	170 / 7
Elevation difference (in / out)		m	50 (OU above) 35 (OU below)
Refrigerant (R410A) / CO <sub>2</sub> Eq.		kg / T	11,50 / 24,00
Operating range	Heat Min ~ Max	°C	-21 ~ +24 (until outlet temperature 45)
Water outlet temperature range	Cool Min ~ Max	°C	-15 ~ +15
	Heat Min ~ Max	°C	+35 ~ +55

1) Unit efficiency energy level: Scale from A+++ to D. 2) ErP test data. Seasonal space cooling / heating energy efficiency following COMMISSION REGULATION (EU) 813/2013.

Performance calculation in agreement with Eurovent. Sound pressure measured at 1 m from the outdoor unit and at 1,5 m height.

### Accessories

**PAW-3WSK** Stacking kit for vertically stacking up to 3 WHE (4 pieces per Kit)

### Technical focus

- Heating, cooling and DHW
- A class water pump included (only in P model)
- Installation up to 80 kW
- Free DHW from waste heat of engine
- Compatible with all centralized controllers
- Maximum distance between outdoor unit and WHE: 170 m
- Hot water outlet temperatures from 35 °C to 55 °C
- Chilled water outlet temperatures from -15 °C to +15 °C
- Minimum outdoor temperature in heating mode: -21 °C



# Leak detection and automatic Pump Down for R410A refrigerant

Pump Down Systems to detect refrigerant leaks, that offers complete assurance and safety protection. It's an ideal solution for hotels, offices and public buildings where the strict safety of end users and workers is required.



The system monitors refrigerant leakage continually and provides a warning, preventing major refrigerant loss and potential damage to the installation's efficiency. The system can reduce potential refrigerant loss by up to 90%.

As well as ensuring safe and reliable operation, Panasonic's Pump Down system contributes towards BREEAM POL1 points and enables compliance with current EN 378 standards, covering applications where refrigeration concentration levels exceed practical safety limits of 0,44 kg/m<sup>3</sup>.

## Basic Pump Down function:

- Leak detection
- Activate Pump Down process
- Collect refrigerant within receiver tank
- Close valves to isolate refrigerant

## Technical focus:

- Compatible with Mini ECOi / ECOi EX / ECO G\* Series with R410A refrigerant
- A receiver kit included as standard
- Includes updated controller
- Connection in two ways:
  - 1 | With local room leakage sensors
  - 2 | Using innovative algorithm
- R22 renewal possible

\* For connection to GHP, additional components required dependent on configuration. Please contact your local Panasonic representative for details.





The Pump Down systems are ideal for hotels, offices and public buildings where safety of building occupants is a must.

### Direct leak detection method: the safest solution for small rooms

The leak detector is connected directly to the indoor unit and the Pump Down system is directly connected to the outdoor unit PCB. The Pump Down system will activate when a leak is detected in the room and initiate a refrigerant reclaim operation immediately. This immediate reaction, and large refrigerant storage capacity, offers very high levels of safety for end users, building occupants, as well as being environmentally friendly. No additional communication panels or software is required. This option should be implemented in any area that is not compliant with BS EN 378.

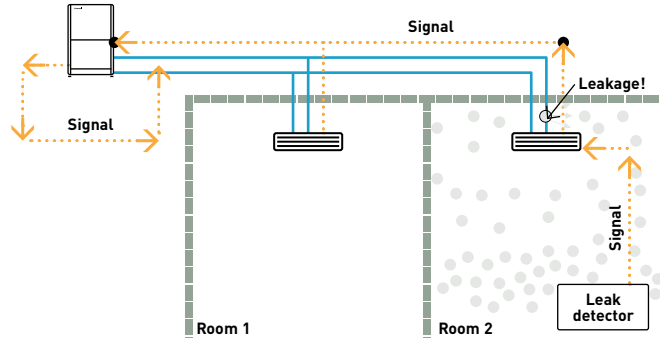

### Indirect leak detection method: Unique PLC algorithm to determine refrigerant leakage

Pressure and temperature sensors constantly monitor the high / low pressure and discharge of the condensing unit to protect against potential leakage in areas not covered by leak detectors.

The innovative algorithm is able to detect leakage of R410A based on abnormal changes in the following conditions, high and low pressure, and compressor discharge temperature.

Once initiated via either direct or indirect detection, the unit will immediately close the liquid / discharge actuating ball valves, close the alarm terminals on the Pump Down PCB allowing an alarm to be raised at any nominated location. Reclaim of the refrigerant is via the suction line to the heat exchanger(s) of the outdoor unit(s), with any surplus refrigerant collected in the 30 l receiver tank. Once fully pumped down the suction line is closed and the unit awaits a 'Reset' and 'Recharge' command.

Thanks to the simple installation and control, shown in Fig 1, Panasonic's ECOi Pump Down system can provide dramatic reduction in capital cost and installation time when compared to a standalone leak detection system, shown in Fig 2.

Fig 1: Panasonic's Pump Down system.

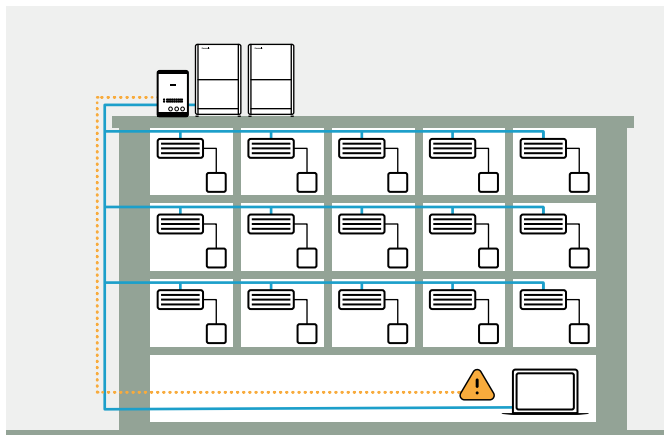
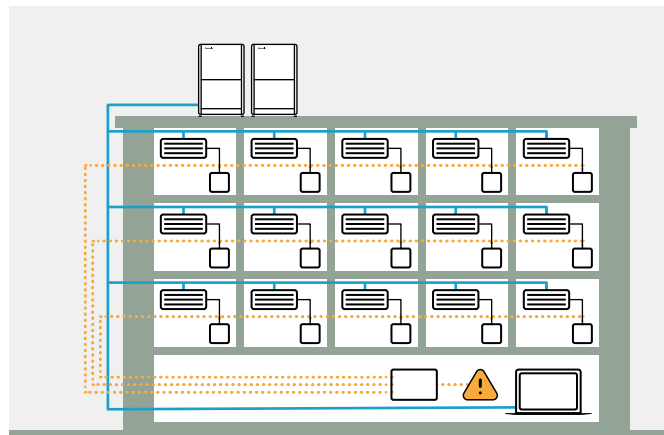

Fig 2: Standalone leak detection system.



### Quick and simple installation

The unit contains actuating ball valves, a 30 L storage vessel and PLC all housed in an IP54 rated encasement. Terminals in front of the unit allow easy wiring to the alarm terminal, high / low pressure transducers and discharge temperature sensor(s) of the condensing unit(s).

Reference	Description
PAW-PUD2W-1R	Pump Down system (2 way) for 1 outdoor unit
PAW-PUD2W-2R	Pump Down system (2 way) for 2 outdoor units
PAW-PUD2W-3R*	Pump Down system (2 way) for 3 outdoor units
PAW-PUD3W-1R	Pump Down system (3 way) for 1 outdoor unit
PAW-PUD3W-2R	Pump Down system (3 way) for 2 outdoor units
PAW-PUD3W-3R*	Pump Down system (3 way) for 3 outdoor units





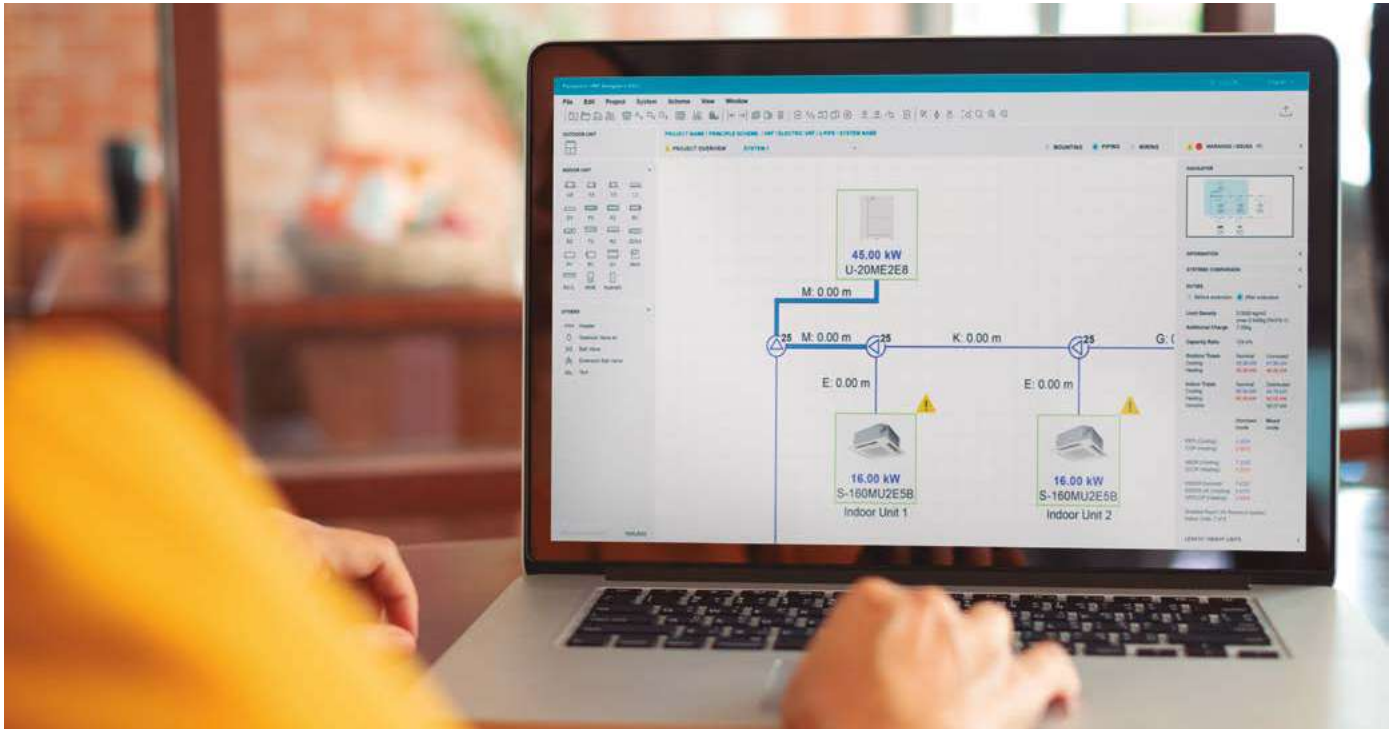

\* Special order requiring the longer lead time than usual. For the detailed information, please contact an authorized Panasonic dealer.

# Panasonic DX PRO Designer

Leading software for architects, designers, and consultants, specializing in the design of commercial DX heating and cooling systems.



Cloud based solution: Access from anywhere 24/7/365, collaborative work with your team and the software is consistently updated to the latest version.

					
<b>Cloud based tool.</b>	<b>Design on building floor drawing.</b>	<b>Auto piping and wiring diagram.</b>	<b>Performance calculation.</b>	<b>Comprehensive project report.</b>	<b>Floor drawing image import.</b>

## DX PRO Designer offers improved user experience and useful functions for the heating and cooling experts

- Seasonal performance calculation in accordance with ERP directive and EN14825 standard
- Designing heating and cooling systems for floor-level building design
- Automatic piping and wiring function
- Limit density check function in accordance with IEC 60335-2-40 / EN 378
- Comprehensive project report available
- Multi language supports

**The software performs seasonal performance calculations, considering on-site conditions.**



**Download the comprehensive project report.**



**Let's try out the DX PRO Designer\***



\* Panasonic PRO Club account is required.

**The video for detailed information is ready!**



## Panasonic VRF service checker

Available to installers and commissioning companies, the VRF service checker is a communication interface to Panasonic VRF systems. This easy to manage tool checks all parameters of the system.

### The VRF service checker.

- Connect anywhere on the S-Link for ECOi and Mini ECOi
- Search the S-Link to validate systems that are connected
- Monitor all indoor and outdoor units simultaneously on 1 screen
- Monitor all Temperature data, Pressure data, Valve position, and alarm status
- Data can be viewed in Graph or tabular display
- Controlling the indoor unit ON / OFF, MODE, SET POINT, FAN, and TEST mode
- Switch between various systems on the same communication S-Link (ECOi only)
- Monitor and record at a set interval
- Record and review the data at a later date
- Update Panasonic system software via ROM flash writer

The Panasonic VRF service checker is available from your local service partner.

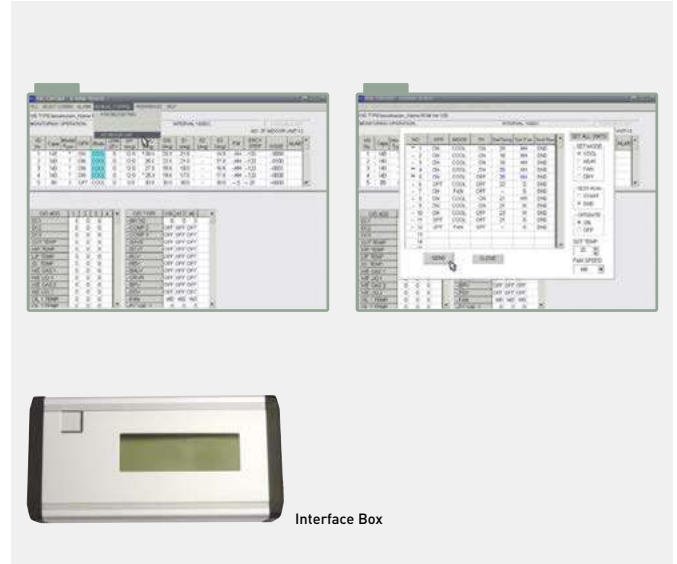

## R22 Renewal







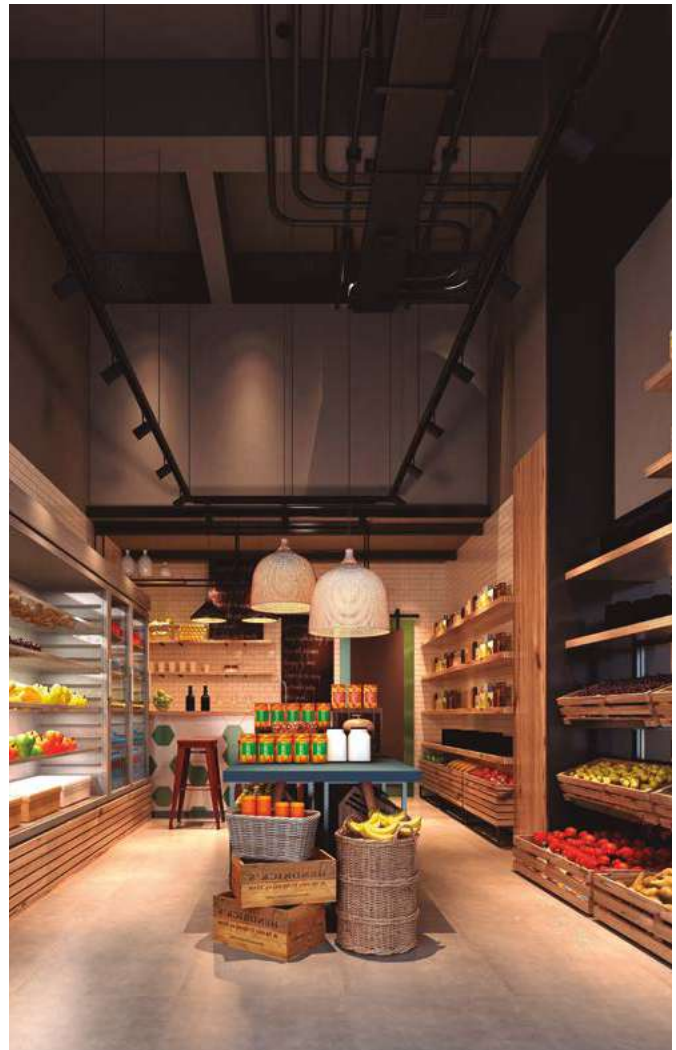





























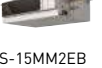





















Panasonic's advanced technology enables the system to work with previously installed pipe work by managing the working pressure within the system down to R22 (33 bar) levels, this ensures the system works safely and efficiently without loss of capacity.

The new equipment can offer increased COP / EER by using state of the art Inverter compressor and heat exchanger technology.

Having contacted your Panasonic supplier regarding pipe work restrictions, and gained approval to use the Panasonic Renewal System, there are three main tests that have to be carried out to ensure that the system can be used effectively. Firstly a thorough inspection of the pipe work must be carried out and any damage must be repaired. Secondly an oil test must be performed to ensure that the system has not been subject to a compressor burnout during its lifetime. Lastly a VRF Renewal Kit (CZ-SLK2) must be installed within the pipe work to ensure that the system is cleaned and free of oil remnants.



# ECOi and ECO G indoor units range

Page	Indoor units	1,0 kW	1,5 kW	2,2 kW	2,8 kW	3,6 kW	4,5 kW	5,6 kW
P. 359	U2 type 4 way 90x90 cassette · R32 / R410A			 S-22MU2E5C	 S-28MU2E5C	 S-36MU2E5C	 S-45MU2E5C	 S-56MU2E5C
P. 360	Y3 type 4 way 60x60 cassette · R32 / R410A	 S-15MY3EB	 S-22MY3EB	 S-28MY3EB	 S-36MY3EB	 S-45MY3EB	 S-56MY3EB	
P. 361	L1 type 2 way cassette · R410A			 S-22ML1E5	 S-28ML1E5	 S-36ML1E5	 S-45ML1E5	 S-56ML1E5
P. 362	D1 type 1 way cassette · R410A				 S-28MD1E5	 S-36MD1E5	 S-45MD1E5	 S-56MD1E5
P. 363	F3 type variable static pressure adaptive duct · R32 / R410A	 S-15MF3E5D	 S-22MF3E5D	 S-28MF3E5D	 S-36MF3E5D	 S-45MF3E5D	 S-56MF3E5D	
P. 364	<b>NEW</b> M2 type slim variable static pressure hide-away · R32 / R410A	 S-10MM2EB	 S-15MM2EB	 S-22MM2EB	 S-28MM2EB	 S-36MM2EB	 S-45MM2EB	 S-56MM2EB
P. 365	E2 type high static pressure hide-away · R410A							
P. 367	<b>NEW</b> K3 type wall-mounted · R32 / R410A	 S-15MK3E	 S-22MK3E	 S-28MK3E	 S-36MK3E	 S-45MK3E	 S-56MK3E	
P. 368	T2 type ceiling · R410A					 S-36MT2E5A	 S-45MT2E5A	 S-56MT2E5A
P. 369	G1 type floor console · R410A			 S-22MG1E5N	 S-28MG1E5N	 S-36MG1E5N	 S-45MG1E5N	 S-56MG1E5N
P. 370	P1 type floor-standing · R410A			 S-22MP1E5	 S-28MP1E5	 S-36MP1E5	 S-45MP1E5	 S-56MP1E5
P. 370	R1 type concealed floor-standing · R410A			 S-22MR1E5	 S-28MR1E5	 S-36MR1E5	 S-45MR1E5	 S-56MR1E5
P. 371	Hydrokit for ECOi, water at 45 °C · R410A							
P. 373	<b>NEW</b> HT Booster for ECOi EX Series, water at 70 °C · R410A							
P. 377	Energy recovery ventilation with DX coil - HRPT Series · R32 / R410A			 PAW-HRPT40 (2,5 kW)				 PAW-HRPT80 (5 kW)

+ OPTIONAL UNITS ON VENTILATION SECTION

6,0 kW

7,3 kW

9,0 kW

10,6 kW

11,2 kW

14,0 kW

16,0 kW

22,4 kW

28,0 kW



S-60MU2E5C



S-73MU2E5C



S-90MU2E5C



S-112MU2E5C



S-140MU2E5C



S-160MU2E5C

A new panel in graphite black (RAL9011) is available.



S-73ML1E5



S-73MD1E5



S-60MF3E5D



S-73MF3E5D



S-90MF3E5D



S-112MF3E5D



S-140MF3E5D



S-160MF3E5D



S-224ME2E5



S-280ME2E5

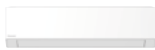

S-73MK3E



S-106MK3E



S-73MT2E5A



S-106MT2E5A



S-140MT2E5A



S-71MP1E5



S-71MR1E5



S-80MW1E5



S-125MW1E5



P-250WXHT1E5  
(25,0 kW)



PAW-HRPT120HX  
PAW-HRPT120 (7 kW)



PAW-HRPT160HX  
PAW-HRPT160 (10 kW)



PAW-HRPT200HX  
PAW-HRPT200 (12,5 kW)

# 4 way 90x90 cassette with nanoe X Generator Mark 3



Large capacity VRF. Trusted power and high efficiency. These Cassettes offer upgraded nanoe™ X technology and Econavi as accessories for making application space more comfortable and efficient.

White and graphite black panels now available for the 4 way 90x90 cassette, offering versatile options for commercial applications.



Standard panel, white (RAL9003). CZ-KPU3

Standard panel, graphite black (RAL9011). CZ-KPU3B

Econavi panel, white (RAL9003). CZ-KPU3A



## Always fresh and clean air with nanoe™ X

The 4 way 90x90 cassette with nanoe™ X, when tested, has shown to inhibit hazardous substances by 92%, when compared to natural reduction\*. In addition to the 7 effects of nanoe™ X, the indoor unit can also be cleaned with a short operation of nanoe™ X and dry operation.

\* Controllers (CZ-RTC5B or CZ-RTC6/BL/BLW) are required.

After cooling/drying operation, the inside of the indoor unit is automatically dried and nanoe™ X is activated to suppress mould growth.

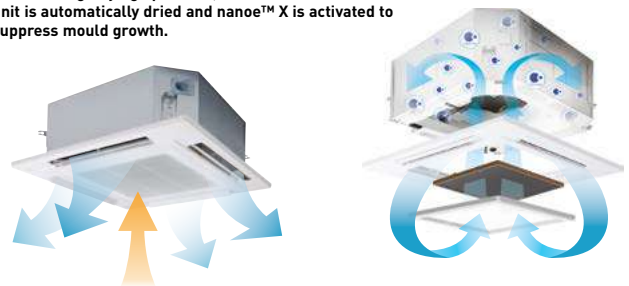

Operates the fan to discharge internal humidity.

Operate the fan to circulate nanoe™ X internally.

## Optional Econavi intelligent sensor

Human activity sensor and floor temperature sensor can reduce waste energy, by optimising air conditioner operation.

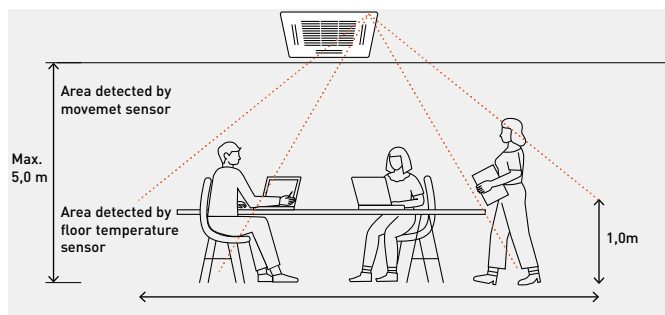

## Advanced Econavi functions.



2 sensors (movement and floor temperature) can provide a reduction in wasted energy by means of effective control. The floor temperature can be detected with a ceiling height of up to 5 m.

Econavi exclusive panel. Optional (CZ-KPU3A).

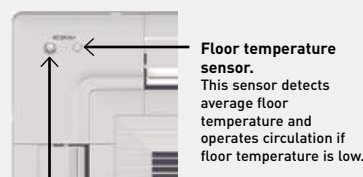

**Movement sensor.** This sensor detects the amount of human activity, and operates effectively.

**Floor temperature sensor.** This sensor detects average floor temperature and operates circulation if floor temperature is low.



Wired remote controller CZ-RTC5B, CZ-RTC6W/BL or CZ-RTC6/BL is required.

## Humidity sensor.

A humidity sensor positioned in the air inlet provides comfort and saves energy based on temperature and humidity.

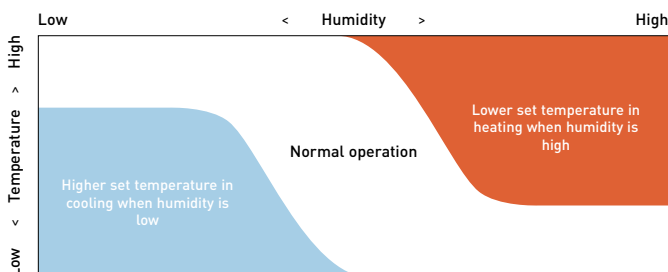

## Group control, circulation function.

Circulating operation is activated when a room is unoccupied to evenly distribute air and minimize thermal stratification in both heating and cooling operation.

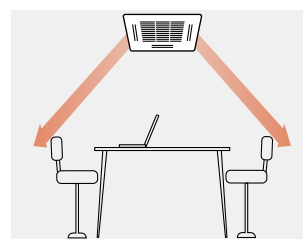

Circulation by detecting no movement (10 minutes).

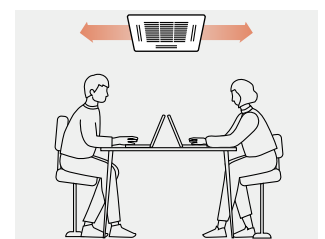

Indirect air flow by detecting movement.

U2 type 4 way 90x90 cassette · R32 / R410A

The 4 way 90x90 cassettes with integrated nanoe X Generator Mark 3 and design panel.



Panels (sold separately):

Standard, white (RAL9003). CZ-KPU3

Econavi, white (RAL9003). CZ-KPU3A

Standard, graphite black (RAL9011). CZ-KPU3B



COMPATIBLE WITH ALL PANASONIC CONNECTIVITY SOLUTIONS. FOR DETAILED INFORMATION GO TO THE CONTROL SYSTEMS SECTION

Indoor unit. S-***MU2E5C			22	28	36	45	56	60	73	90	112	140	160
Cooling capacity	kW		2,2	2,8	3,6	4,5	5,6	6,0	7,3	9,0	11,2	14,0	16,0
Input power	W		20,00	20,00	20,00	20,00	25,00	35,00	40,00	40,00	95,00	95,00	105,00
Current	A		0,21	0,21	0,21	0,21	0,23	0,33	0,36	0,38	0,74	0,74	0,82
Heating capacity	kW		2,5	3,2	4,2	5,0	6,3	7,1	8,0	10,0	14,0	16,0	18,0
Input power	W		20,00	20,00	20,00	20,00	25,00	35,00	40,00	40,00	90,00	90,00	100,00
Current	A		0,20	0,20	0,20	0,20	0,22	0,32	0,35	0,37	0,72	0,72	0,80
Fan type			Turbo fan	Turbo fan	Turbo fan	Turbo fan	Turbo fan	Turbo fan	Turbo fan	Turbo fan	Turbo fan	Turbo fan	Turbo fan
nanoe X Generator			Mark 3	Mark 3	Mark 3	Mark 3	Mark 3	Mark 3	Mark 3	Mark 3	Mark 3	Mark 3	Mark 3
Air flow	Hi/ Med/ Lo	m <sup>3</sup> /min	12,8/12,1/11,5	12,8/12,1/11,5	14,5/13,0/11,5	15,5/13,0/11,5	16,5/13,5/11,5	21,0/16,0/13,0	22,5/16,0/13,0	23,0/18,5/14,0	36,0/26,0/20,0	36,0/26,0/20,0	37,0/28,0/24,0
Sound pressure		dB(A)	30/29/28	30/29/28	30/29/28	31/29/28	32/30/28	36/32/29	37/32/29	38/35/32	45/39/35	45/39/35	46/40/38
Sound power		dB(A)	45/44/43	45/44/43	45/44/43	46/44/43	47/45/43	51/47/44	52/47/44	53/50/47	60/54/50	60/54/50	61/55/53
Dimension (HxWxD)	Indoor	mm	256 x 840 x 840	256 x 840 x 840	256 x 840 x 840	256 x 840 x 840	256 x 840 x 840	256 x 840 x 840	256 x 840 x 840	256 x 840 x 840	319 x 840 x 840	319 x 840 x 840	319 x 840 x 840
	Panel	mm	33,5 x 950 x 950	33,5 x 950 x 950	33,5 x 950 x 950	33,5 x 950 x 950	33,5 x 950 x 950	33,5 x 950 x 950	33,5 x 950 x 950	33,5 x 950 x 950	33,5 x 950 x 950	33,5 x 950 x 950	33,5 x 950 x 950
Net weight (Panel)	kg		20(5)	20(5)	20(5)	20(5)	20(5)	20(5)	20(5)	20(5)	25(5)	25(5)	25(5)
Piping diameter R32 model	Liquid	Inch (mm)	1/4(6,35)	1/4(6,35)	1/4(6,35)	1/4(6,35)	1/4(6,35)	1/4(6,35)	1/4(6,35)	1/4(6,35)	3/8(9,52)	3/8(9,52)	3/8(9,52)
	Gas	Inch (mm)	1/2(12,70)	1/2(12,70)	1/2(12,70)	1/2(12,70)	1/2(12,70)	1/2(12,70)	1/2(12,70)	1/2(12,70)	5/8(15,88)	5/8(15,88)	5/8(15,88)
Piping diameter R410A model	Liquid	Inch (mm)	1/4(6,35)	1/4(6,35)	1/4(6,35)	1/4(6,35)	1/4(6,35)	3/8(9,52) <sup>1)</sup>	3/8(9,52) <sup>1)</sup>	3/8(9,52) <sup>1)</sup>	3/8(9,52)	3/8(9,52)	3/8(9,52)
	Gas	Inch (mm)	1/2(12,70)	1/2(12,70)	1/2(12,70)	1/2(12,70)	1/2(12,70)	5/8(15,88) <sup>1)</sup>	5/8(15,88) <sup>1)</sup>	5/8(15,88) <sup>1)</sup>	5/8(15,88)	5/8(15,88)	5/8(15,88)

1) When the piping diameter is (liquid) Ø1/4 (6,35) - (gas) Ø1/2 (12,70), connect the liquid socket tube (Ø1/4 (6,35) - Ø3/8 (9,52)) to the liquid tubing side indoor unit and connect the gas socket tube (Ø1/2 (12,70) - Ø5/8 (15,88)) to the gas tubing side indoor unit. \* Above values are in the case of nanoe™ X OFF.

Accessories	
CZ-RTC6W	CONEX wired remote controller (non-wireless), white
CZ-RTC6WBL	CONEX wired remote controller with Bluetooth®, white
CZ-RTC6	CONEX wired remote controller (non-wireless), black
CZ-RTC6BL	CONEX wired remote controller with Bluetooth®, black
CZ-RTC5B	Wired remote controller with Econavi function
CZ-RWS3 + CZ-RWRU3	Infrared remote controller and receiver
PAW-RE2C4-MOD-WH	Room controller for hotel rooms, white
PAW-RE2C4-MOD-BK	Room controller for hotel rooms, black

Accessories	
PAW-RE2D4-WH	Display control for hotel rooms, white
PAW-RE2D4-BK	Display control for hotel rooms, black
CZ-KPU3	Standard panel, white (RAL9003)
CZ-KPU3B	Standard panel, graphite black (RAL9011)
CZ-KPU3A	Econavi exclusive panel, white (RAL9003)
CZ-CENSC1	Econavi energy saving sensor
CZ-FDU3+CZ-ATU2	Fresh air-intake kit
CZ-CGLSC2	Panasonic R32 refrigerant leak detector

Technical focus

- High performance turbo fan
- Lower noise in low fan operation
- Ceiling height up to 5,0 m
- Industry leading lightweight design
- Econavi: Temperature, humidity and activity sensor
- nanoe™ X (Generator Mark 3: 48 trillion hydroxyl radicals/sec) as standard for better indoor air quality, indoor unit internal cleaning with nanoe™ X and dry operation
- Powerful drain pump gives 850 mm lift
- Fresh air knockout
- Branch duct connection
- High volume fresh air input with optional air-intake plenum and chamber (CZ-FDU3+CZ-ATU2)
- **New** graphite black and white panels providing options to suit a variety of light commercial applications

Panel design

A modern flat panel design blends into any space. These cassettes provide high energy saving, comfort and better indoor air quality that satisfy customers.

- Flat design, well-matched with interior aesthetic
- 4-way individual flap control

The drain pipe can be raised to a maximum height of 850 mm from the bottom of the ceiling

Integrated drain pump allows a drain height of 850 mm making the installation much easier.

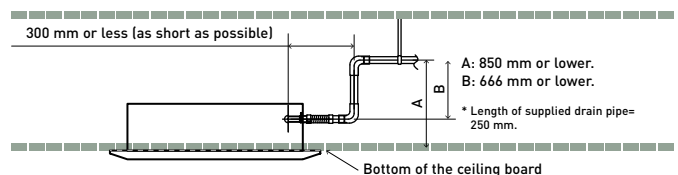

ECONAVI and INTERNET CONTROL: Optional.

Rating conditions: Cooling indoor 27 °C DB / 19 °C WB. Cooling outdoor 35 °C DB / 24 °C WB. Heating indoor 20 °C DB. Heating outdoor 7 °C DB / 6 °C WB. (DB: Dry Bulb, WB: Wet Bulb). Specifications subject to change without notice. For detailed information about ErP / Energy Labelling, please visit our websites www.aircon.panasonic.eu or www.ptc.panasonic.eu.

## Y3 type 4 way 60x60 cassette · R32 / R410A

Mini cassette with a modern panel design is available in VRF range.

The Y3 type not only perfectly matches with 600 x 600 mm ceiling grids but also provides the additional benefits of nanoe™ X, for better indoor air quality.



Panel.  
CZ-KPY4



+ COMPATIBLE WITH ALL PANASONIC CONNECTIVITY SOLUTIONS. FOR DETAILED INFORMATION GO TO THE CONTROL SYSTEMS SECTION

Indoor unit			S-15MY3EB	S-22MY3EB	S-28MY3EB	S-36MY3EB	S-45MY3EB	S-56MY3EB
Cooling capacity	kW		1,5	2,2	2,8	3,6	4,5	5,6
Input power	W		19,00	20,00	21,00	22,00	30,00	42,00
Current	A		0,24	0,24	0,25	0,26	0,34	0,43
Heating capacity	kW		1,7	2,5	3,2	4,2	5,0	6,3
Input power	W		17,00	18,00	19,00	20,00	28,00	40,00
Current	A		0,21	0,21	0,22	0,23	0,31	0,40
Fan type			Turbo fan	Turbo fan	Turbo fan	Turbo fan	Turbo fan	Turbo fan
nanoe X Generator			Mark 3	Mark 3	Mark 3	Mark 3	Mark 3	Mark 3
Air flow	Cool (Hi/Med/Lo)	m <sup>3</sup> /min	8,5/7,0/6,0	8,7/7,0/6,0	9,0/7,5/6,0	9,5/7,8/6,0	11,5/9,0/6,5	13,5/10,5/8,0
	Heat (Hi/Med/Lo)	m <sup>3</sup> /min	8,5/7,0/6,0	8,7/7,0/6,0	9,0/7,5/6,0	9,5/7,8/6,0	11,5/9,0/6,5	13,5/10,5/8,0
Sound pressure	Hi/Med/Lo	dB(A)	33/30/28	33/30/28	34/30/28	35/31/28	39/34/30	42/37/33
Sound power	Hi/Med/Lo	dB(A)	48/45/43	48/45/43	49/45/43	50/46/43	54/49/45	57/52/48
Dimension (H x W x D) <sup>1)</sup>	Indoor	mm	243 x 575 x 575	243 x 575 x 575	243 x 575 x 575	243 x 575 x 575	243 x 575 x 575	243 x 575 x 575
	Panel	mm	30 x 625 x 625	30 x 625 x 625	30 x 625 x 625	30 x 625 x 625	30 x 625 x 625	30 x 625 x 625
Net weight		kg	17,8(15+2,8)	17,8(15+2,8)	17,8(15+2,8)	17,8(15+2,8)	17,8(15+2,8)	17,8(15+2,8)
Piping diameter	Liquid	Inch (mm)	1/4 (6,35)	1/4 (6,35)	1/4 (6,35)	1/4 (6,35)	1/4 (6,35)	1/4 (6,35)
	Gas	Inch (mm)	1/2 (12,70)	1/2 (12,70)	1/2 (12,70)	1/2 (12,70)	1/2 (12,70)	1/2 (12,70)

1) Unit height is 230 mm, but need 243 mm height in ceiling space for its installation.

### Accessories

<b>CZ-RTC6W</b>	CONEX wired remote controller (non-wireless), white
<b>CZ-RTC6WBL</b>	CONEX wired remote controller with Bluetooth®, white
<b>CZ-RTC6WBLW2</b>	CONEX wired remote controller with Wi-Fi and Bluetooth®, white
<b>CZ-RTC6</b>	CONEX wired remote controller (non-wireless), black
<b>CZ-RTC6BL</b>	CONEX wired remote controller with Bluetooth®, black
<b>CZ-RTC6BLW2</b>	CONEX wired remote controller with Wi-Fi and Bluetooth®, black
<b>CZ-RTC5B</b>	Wired remote controller with Econavi function
<b>CZ-RWS3 + CZ-RWRY3</b>	Infrared remote controller and receiver

### Accessories

<b>PAW-RE2C4-MOD-WH</b>	Room controller for hotel rooms, white
<b>PAW-RE2C4-MOD-BK</b>	Room controller for hotel rooms, black
<b>PAW-RE2D4-WH</b>	Display control for hotel rooms, white
<b>PAW-RE2D4-BK</b>	Display control for hotel rooms, black
<b>CZ-CENSC1</b>	Econavi energy saving sensor
<b>CZ-CGLSC2</b>	Panasonic R32 refrigerant leak detector
<b>CZ-KPY4</b>	Panel for 4 way 60x60 cassette

### Technical focus

- Built-in drain pump
- DC drain pump and float switch to reduce the noise
- nanoe™ X (Generator Mark 3: 48 trillion hydroxyl radicals/sec) as standard for better indoor air quality, indoor unit internal cleaning with nanoe™ X and dry operation

### Compact and stylish design

- Required ceiling depth of only 250 mm<sup>1)</sup>
- Exposed area is only 30 mm

1) Installation dimension.

### Individual flap control

Better control of the air flow with 4 motors, providing individual flap control.

Perfect air distribution without direct air flow, to reduce the feeling of cold drafts.

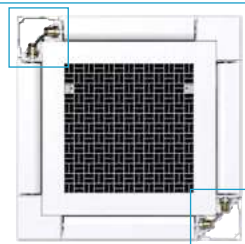

### Internal cleaning function

When cooling or dry operation stopped, internal drying and nanoe™ X circulation air flow is activated in order to suppress the mould proliferation inside the unit (air flow passage, fan, heat exchanger)\*.

\* Depending on the installation environment or operating hours, mould proliferation or inhabitation of mould growth will be changed.

After cooling/drying operation, the inside of the indoor unit is automatically dried and nanoe™ X is activated to suppress mould growth.

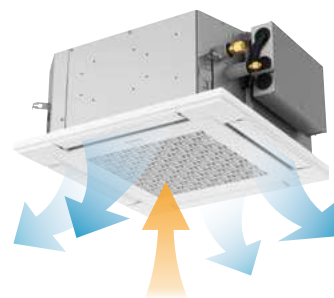

Operates the fan to discharge internal humidity.

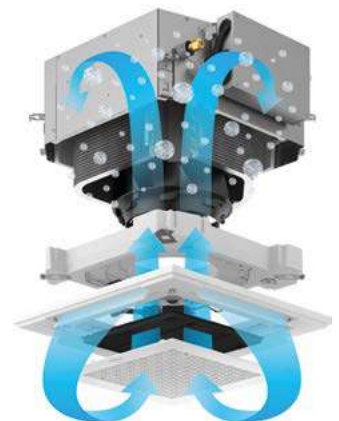

Operate the fan to circulate nanoe™ X internally.



ECONAVI and INTERNET CONTROL: Optional.



## L1 type 2 way cassette - R410A

### Slim, compact and lightweight units.

Remarkable size and weight reductions have been achieved by improvement of the design around the fan, the weight of all models now just 30 kg.



+ COMPATIBLE WITH ALL PANASONIC CONNECTIVITY SOLUTIONS. FOR DETAILED INFORMATION GO TO THE CONTROL SYSTEMS SECTION

Indoor unit			S-22ML1E5	S-28ML1E5	S-36ML1E5	S-45ML1E5	S-56ML1E5	S-73ML1E5
Cooling capacity	kW		2,2	2,8	3,6	4,5	5,6	7,3
Input power	W		90,00	92,00	93,00	97,00	97,00	145,00
Current	A		0,45	0,45	0,45	0,45	0,45	0,65
Heating capacity	kW		2,5	3,2	4,2	5,0	6,3	8,0
Input power	W		58,00	60,00	61,00	65,00	65,00	109,00
Current	A		0,29	0,29	0,29	0,29	0,29	0,48
Fan type			Sirocco fan	Sirocco fan	Sirocco fan	Sirocco fan	Sirocco fan	Sirocco fan
Air flow	Hi/Med/Lo	m <sup>3</sup> /min	8,0/7,0/6,0	9,0/8,0/7,0	9,7/8,7/7,7	11,0/9,0/8,0	11,0/9,0/8,0	19,0/16,0/14,0
Sound pressure	Hi/Med/Lo	dB(A)	30/27/24	33/29/26	34/31/28	35/33/29	35/33/29	38/35/33
Dimension (HxWxD)	Indoor	mm	350x840x600	350x840x600	350x840x600	350x840x600	350x840x600	350x1140x600
	Panel	mm	8x1060x680	8x1060x680	8x1060x680	8x1060x680	8x1060x680	8x1360x680
Net weight (Panel)		kg	26(8)	26(8)	26(8)	26(8)	26(8)	26(8)
Piping diameter	Liquid	Inch (mm)	1/4(6,35)	1/4(6,35)	1/4(6,35)	1/4(6,35)	1/4(6,35)	3/8(9,52)
	Gas	Inch (mm)	1/2(12,70)	1/2(12,70)	1/2(12,70)	1/2(12,70)	1/2(12,70)	5/8(15,88)

#### Accessories

<b>CZ-RTC6W</b>	CONEX wired remote controller (non-wireless), white
<b>CZ-RTC6WBL</b>	CONEX wired remote controller with Bluetooth®, white
<b>CZ-RTC6</b>	CONEX wired remote controller (non-wireless), black
<b>CZ-RTC6BL</b>	CONEX wired remote controller with Bluetooth®, black
<b>CZ-RTC5B</b>	Wired remote controller with Econavi function
<b>CZ-RWS3 + CZ-RWRL3</b>	Infrared remote controller and receiver

#### Accessories

<b>PAW-RE2C4-MOD-WH</b>	Room controller for hotel rooms, white
<b>PAW-RE2C4-MOD-BK</b>	Room controller for hotel rooms, black
<b>PAW-RE2D4-WH</b>	Display control for hotel rooms, white
<b>PAW-RE2D4-BK</b>	Display control for hotel rooms, black
<b>CZ-02KPL2</b>	Panel for S-22 to S-56 models
<b>CZ-03KPL2</b>	Panel for S-73 model

### Technical focus

- Air flow and distribution is automatically altered depending on the operational mode of the unit
- Drain pump provides up to 500 mm lift height
- Simplified maintenance

### Simplified maintenance

The drain pan is equipped with site wiring and can be removed. The fan case has a split construction, and the fan motor can be removed easily when the lower case is removed.

### Auto flap control

Air flow and distribution is automatically altered depending on the operational mode of the unit.

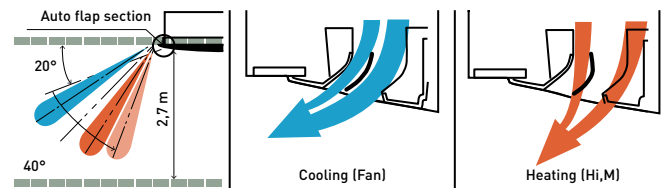

### Drain pump provides up to 500 mm lift height

Maintenance of the drain pump is possible from two sides, from the left side (piping side) and from the inside of the unit.

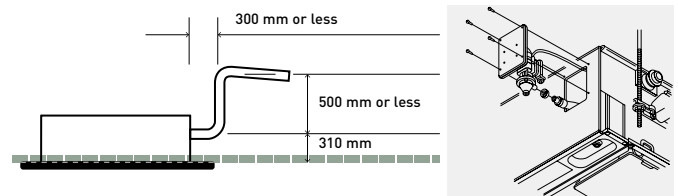

INTERNET CONTROL: Optional.

Rating conditions: Cooling indoor 27 °C DB / 19 °C WB. Cooling outdoor 35 °C DB / 24 °C WB. Heating indoor 20 °C DB. Heating outdoor 7 °C DB / 6 °C WB. (DB: Dry Bulb, WB: Wet Bulb). Specifications subject to change without notice. For detailed information about ErP / Energy Labelling, please visit our websites [www.aircon.panasonic.eu](http://www.aircon.panasonic.eu) or [www.ptc.panasonic.eu](http://www.ptc.panasonic.eu).

## D1 type 1 way cassette · R410A

Designed for installation within the ceiling void, the D1 range of slimline 1 way blow cassettes feature powerful yet quiet fans for installation of up to 4,2 m.



+ COMPATIBLE WITH ALL PANASONIC CONNECTIVITY SOLUTIONS. FOR DETAILED INFORMATION GO TO THE CONTROL SYSTEMS SECTION

Indoor unit			S-28MD1E5	S-36MD1E5	S-45MD1E5	S-56MD1E5	S-73MD1E5
Cooling capacity	kW		2,8	3,6	4,5	5,6	7,3
Input power	W		51,00	51,00	51,00	60,00	87,00
Current	A		0,39	0,39	0,39	0,46	0,70
Heating capacity	kW		3,2	4,2	5,0	6,3	8,0
Input power	W		40,00	40,00	40,00	48,00	76,00
Current	A		0,35	0,35	0,35	0,41	0,65
Fan type			Sirocco fan	Sirocco fan	Sirocco fan	Sirocco fan	Sirocco fan
Air flow	Hi/Med/Lo	m <sup>3</sup> /min	12,0/10,0/9,0	12,0/10,0/9,0	12,0/11,0/10,0	13,0/11,5/10,0	18,0/15,0/13,0
Sound pressure	Hi/Med/Lo	dB(A)	36/34/33	36/34/33	36/35/34	38/36/34	45/40/36
Dimension (H x W x D)	Indoor	mm	200 x 1000 x 710	200 x 1000 x 710	200 x 1000 x 710	200 x 1000 x 710	200 x 1000 x 710
	Panel	mm	20 x 1230 x 800	20 x 1230 x 800	20 x 1230 x 800	20 x 1230 x 800	20 x 1230 x 800
Net weight (Panel)		kg	23,5(7,5)	23,5(7,5)	23,5(7,5)	23,5(7,5)	24,5(7,5)
Piping diameter	Liquid	Inch (mm)	1/4 (6,35)	1/4 (6,35)	1/4 (6,35)	1/4 (6,35)	3/8 (9,52)
	Gas	Inch (mm)	1/2 (12,70)	1/2 (12,70)	1/2 (12,70)	1/2 (12,70)	5/8 (15,88)

### Accessories

<b>CZ-RTC6W</b>	CONEX wired remote controller (non-wireless), white
<b>CZ-RTC6WBL</b>	CONEX wired remote controller with Bluetooth®, white
<b>CZ-RTC6</b>	CONEX wired remote controller (non-wireless), black
<b>CZ-RTC6BL</b>	CONEX wired remote controller with Bluetooth®, black
<b>CZ-RTC5B</b>	Wired remote controller with Econavi function
<b>CZ-RWS3 + CZ-RWRD3</b>	Infrared remote controller and receiver

### Accessories

<b>PAW-RE2C4-MOD-WH</b>	Room controller for hotel rooms, white
<b>PAW-RE2C4-MOD-BK</b>	Room controller for hotel rooms, black
<b>PAW-RE2D4-WH</b>	Display control for hotel rooms, white
<b>PAW-RE2D4-BK</b>	Display control for hotel rooms, black
<b>CZ-KPD2</b>	Panel

### Technical focus

- Ultra-Slim
- Suitable for standard and high ceilings
- Built-in drain pump provides 590 mm lift
- Easy to install and maintain
- Hanging height can be easily adjusted
- Uses a DC fan motor to improve energy-efficiency

### Drain height

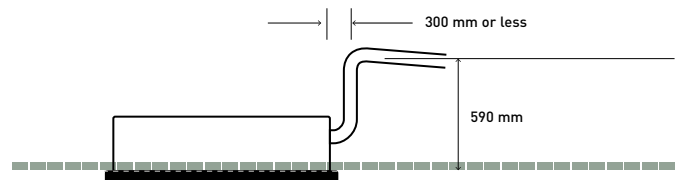

### With 2 types of air-blow systems, the units can be used in various ways



#### 1. One-direction "down-blow" system.

Powerful one-direction "down-blow" system reaches the floor even from high ceilings (up to 4,2 m).



#### 2. Two-direction ceiling-mounted system.

"Down-blow" and "front-blow" systems are combined in a ceiling-mounted unit to blow air over a wide area.



INTERNET CONTROL: Optional.

**F3 type variable static pressure adaptive duct · R32 / R410A**

**Design adaptive ducted F3 range.**

2 installation possibilities (horizontal / vertical) with high ESP 150 Pa allows for flexible installation.



+ COMPATIBLE WITH ALL PANASONIC CONNECTIVITY SOLUTIONS. FOR DETAILED INFORMATION GO TO THE CONTROL SYSTEMS SECTION

Indoor unit. S-***MF3E5D		15	22	28	36	45	56	60	73	90	112	140	160	
Cooling capacity	kW	1,5	2,2	2,8	3,6	4,5	5,6	6,0	7,3	9,0	11,2	14,0	16,0	
Input power	W	60,00	60,00	60,00	60,00	60,00	89,00	79,00	79,00	136,00	265,00	265,00	330,00	
Current	A	0,45	0,45	0,45	0,45	0,45	0,63	0,52	0,52	0,90	1,76	1,76	2,14	
Heating capacity	kW	1,7	2,5	3,2	4,2	5,0	6,3	7,1	8,0	10,0	12,5	16,0	18,0	
Input power	W	60,00	60,00	60,00	60,00	60,00	89,00	79,00	79,00	136,00	265,00	265,00	330,00	
Current	A	0,45	0,45	0,45	0,45	0,45	0,63	0,52	0,52	0,90	1,76	1,76	2,14	
R32 leakage sensors <sup>1)</sup>		2	2	2	2	2	2	2	2	2	2	2	2	
Fan type		Sirocco fan	Sirocco fan	Sirocco fan	Sirocco fan	Sirocco fan	Sirocco fan	Sirocco fan	Sirocco fan	Sirocco fan	Sirocco fan	Sirocco fan	Sirocco fan	
nanoe X Generator		Mark 3	Mark 3	Mark 3	Mark 3	Mark 3	Mark 3	Mark 3	Mark 3	Mark 3	Mark 3	Mark 3	Mark 3	
External static pressure	Pa	30 (10-150)	30 (10-150)	30 (10-150)	30 (10-150)	30 (10-150)	30 (10-150)	30 (10-150)	30 (10-150)	40 (10-150)	50 (10-150)	50 (10-150)	50 (10-150)	
Air flow <sup>2)</sup>	Hi/ Med/ Lo	m <sup>3</sup> /min	12,8/11,0/ 8,0	12,8/11,0/ 8,0	12,8/11,0/ 8,0	14,0/12,0/ 8,0	14,0/12,0/ 8,0	16,0/14,0/ 10,0	21,0/18,0/ 15,0	21,0/18,0/ 15,0	25,0/23,0/ 16,0	37,0/32,0/ 26,0	37,0/32,0/ 26,0	40,0/34,0/ 28,0
Sound pressure		dB(A)	31/28/20	31/28/20	31/28/20	31/28/20	31/28/20	35/32/24	31/28/23	31/28/23	35/33/25	41/36/32	41/36/32	43/37/33
Sound power		dB(A)	54/51/43	54/51/43	54/51/43	54/51/43	54/51/43	58/55/47	54/51/46	54/51/46	58/56/48	64/59/55	64/59/55	66/60/56
Dimension (H x W x D)		mm	250 x 800 x 730	250 x 800 x 730	250 x 800 x 730	250 x 800 x 730	250 x 800 x 730	250 x 800 x 730	250 x 1000 x 730	250 x 1000 x 730	250 x 1000 x 730	250 x 1400 x 730	250 x 1400 x 730	250 x 1400 x 730
Net weight		kg	26	26	26	26	26	26	31	31	31	40	40	40
Piping diameter	Liquid	Inch (mm)	1/4(6,35)	1/4(6,35)	1/4(6,35)	1/4(6,35)	1/4(6,35)	1/4(6,35)	1/4(6,35)	1/4(6,35)	1/4(6,35)	3/8(9,52)	3/8(9,52)	3/8(9,52)
R32 model	Gas	Inch (mm)	1/2(12,70)	1/2(12,70)	1/2(12,70)	1/2(12,70)	1/2(12,70)	1/2(12,70)	1/2(12,70)	1/2(12,70)	1/2(12,70)	5/8(15,88)	5/8(15,88)	5/8(15,88)
Piping diameter	Liquid	Inch (mm)	1/4(6,35)	1/4(6,35)	1/4(6,35)	1/4(6,35)	1/4(6,35)	1/4(6,35)	3/8(9,52)	3/8(9,52)	3/8(9,52)	3/8(9,52)	3/8(9,52)	3/8(9,52)
R410A model	Gas	Inch (mm)	1/2(12,70)	1/2(12,70)	1/2(12,70)	1/2(12,70)	1/2(12,70)	1/2(12,70)	5/8(15,88)	5/8(15,88)	5/8(15,88)	5/8(15,88)	5/8(15,88)	5/8(15,88)

1) Only available in the R32 version. 2) Value referred to standard settings at shipment (H curve 8, M curve 5, L curve 1).

Accessories	
<b>CZ-RTC6W</b>	CONEX wired remote controller (non-wireless), white
<b>CZ-RTC6WBL</b>	CONEX wired remote controller with Bluetooth®, white
<b>CZ-RTC6WBLW2</b>	CONEX wired remote controller with Wi-Fi and Bluetooth®, white
<b>CZ-RTC6</b>	CONEX wired remote controller (non-wireless), black
<b>CZ-RTC6BL</b>	CONEX wired remote controller with Bluetooth®, black
<b>CZ-RTC6BLW2</b>	CONEX wired remote controller with Wi-Fi and Bluetooth®, black
<b>CZ-RTC5B</b>	Wired remote controller with Econavi function
<b>CZ-RWS3 + CZ-RWRC3</b>	Infrared remote controller and receiver
<b>PAW-RE2C4-MOD-WH</b>	Room controller for hotel rooms, white

Accessories	
<b>PAW-RE2C4-MOD-BK</b>	Room controller for hotel rooms, black
<b>PAW-RE2D4-WH</b>	Display control for hotel rooms, white
<b>PAW-RE2D4-BK</b>	Display control for hotel rooms, black
<b>CZ-CENSC1</b>	Econavi energy saving sensor
<b>PAW-APF800F</b>	BION air pollutant filter for MF3 15, 22, 28, 36, 45 and 56
<b>PAW-APF1000F</b>	BION air pollutant filter for MF3 60 and 73
<b>PAW-APF1400F</b>	BION air pollutant filter for MF3 90, 112, 140 and 160
<b>CZ-CGLALC1</b>	R32 refrigerant leak alarm

**Technical focus**

- 4 installation possibilities with horizontal and vertical mounting, plus selectable rear or bottom air inlet
- Industry leading low noise with super quiet operation, minimum 20 dB(A)
- Only 250 mm height and lightweight unit from, 26 to 40 kg
- Integrated Panasonic R32 refrigerant leak detectors <sup>1)</sup>
- Improved drain pan suitable for both horizontal / vertical installation
- Drain pump included <sup>2)</sup>
- nanoe™ X (Generator Mark 3: 48 trillion hydroxyl radicals/sec) as standard, effective even with duct connections up to 10 m with 3 x 90° bends <sup>3)</sup>
- BION air pollutant filter for certain types of pollutants, such as nitrogen dioxide (NO<sub>2</sub>), nitrogen oxides (NO<sub>x</sub>) and Ozone (O<sub>3</sub>) (optional)

1) Only available in the R32 version. 2) For use with horizontal installation only. 3) Panasonic internal survey.

**Vertical Installation**

Vertical installation option. Variable external static pressure to support ducted installations with bends.

\* Vertical installation requires additional settings on field, please check the installation manual.



**Improved drain pan design**

Drain pan is shared in both cases horizontal and vertical installation. No need to modify the unit.

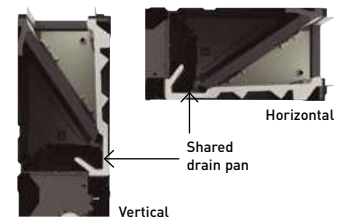

ECONAVI and INTERNET CONTROL: Optional.

## NEW M2 type slim variable static pressure hide-away concealed duct · R32 / R410A

### Upgraded nanoe™ X (Generator Mark 3).

Ultra-slim profile: 200 mm for all capacities.

Ideal for hotel application with very narrow false ceilings.

New  
2025



+ COMPATIBLE WITH ALL PANASONIC CONNECTIVITY SOLUTIONS. FOR DETAILED INFORMATION GO TO THE CONTROL SYSTEMS SECTION

Indoor unit		S-10MM2EB	S-15MM2EB	S-22MM2EB	S-28MM2EB	S-36MM2EB	S-45MM2EB	S-56MM2EB	
Cooling capacity	kW	1,0	1,5	2,2	2,8	3,6	4,5	5,6	
Input power	W	12,00	19,00	25,00	29,00	32,00	39,00	54,00	
Current	A	0,25	0,30	0,33	0,35	0,36	0,44	0,51	
Heating capacity	kW	1,3	1,7	2,5	3,2	4,2	5,0	6,3	
Input power	W	12,00	19,00	25,00	29,00	32,00	39,00	54,00	
Current	A	0,25	0,30	0,33	0,35	0,36	0,44	0,51	
Fan type		Sirocco fan	Sirocco fan	Sirocco fan	Sirocco fan	Sirocco fan	Sirocco fan	Sirocco fan	
Air flow	Hi/Med/Lo	m <sup>3</sup> /min	4,5/4,3/4,1	6,8/6,2/5,0	8,0/7,0/5,0	8,5/7,5/6,5	9,0/8,0/7,0	13,0/11,0/10,5	15,0/13,0/11,0
External static pressure		Pa	10(30)	10(30)	10(30)	15(30)	15(40)	15(40)	15(40)
Sound pressure	Hi/Med/Lo <sup>1)</sup>	dB(A)	22/21/20	24/23/20	26/25/20	27/26/23	28/26/23	30/27/26	32/29/27
Sound power	Hi/Med/Lo	dB(A)	37/36/35	39/38/35	41/40/35	42/41/38	43/41/38	45/42/41	47/44/42
Dimension	HxWxD	mm	200x700x450	200x700x450	200x700x450	200x700x450	200x900x450	200x900x450	
Net weight		kg	17	17	17	17	19	19	
Piping diameter	Liquid	Inch (mm)	1/4(6,35)	1/4(6,35)	1/4(6,35)	1/4(6,35)	1/4(6,35)	1/4(6,35)	
	Gas	Inch (mm)	1/2(12,70)	1/2(12,70)	1/2(12,70)	1/2(12,70)	1/2(12,70)	1/2(12,70)	

1) By DIP switches or by RC setting.

Accessories	
<b>CZ-RTC6W</b>	CONEX wired remote controller (non-wireless), white
<b>CZ-RTC6WBL</b>	CONEX wired remote controller with Bluetooth®, white
<b>CZ-RTC6WBLW2</b>	CONEX wired remote controller with Wi-Fi and Bluetooth®, white
<b>CZ-RTC6</b>	CONEX wired remote controller (non-wireless), black
<b>CZ-RTC6BL</b>	CONEX wired remote controller with Bluetooth®, black
<b>CZ-RTC6BLW2</b>	CONEX wired remote controller with Wi-Fi and Bluetooth®, black
<b>CZ-RTC5B</b>	Wired remote controller with Econavi function

Accessories	
<b>CZ-RWS3 + CZ-RWRC3</b>	Infrared remote controller and receiver
<b>PAW-RE2C4-MOD-WH</b>	Room controller for hotel rooms, white
<b>PAW-RE2C4-MOD-BK</b>	Room controller for hotel rooms, black
<b>PAW-RE2D4-WH</b>	Display control for hotel rooms, white
<b>PAW-RE2D4-BK</b>	Display control for hotel rooms, black
<b>CZ-CENSC1</b>	Econavi energy saving sensor
<b>CZ-CGLALC1</b>	R32 refrigerant leak alarm

### Technical focus

- Ultra-slim profile: 200 mm for all models
- DC fan motor greatly reduces power consumption
- Ideal for hotel application with very narrow false ceilings
- Easy maintenance and service by external electrical box
- Up to 40 Pa static pressure enables ductwork to be fitted
- Includes drain pump

In addition, its high-efficiency and extremely quiet sound levels make it very popular with many users, including hotels and small offices.

### Ultra-slim profile for all models

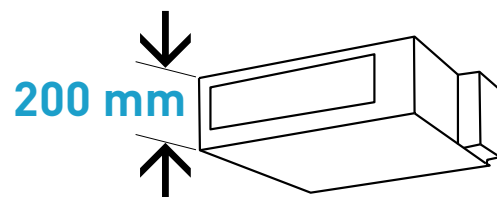

### Drain pump with increased power!

By adoption of a high-lift drain pump, the drain piping can achieve up to 500 mm lift from the outlet port of the unit.

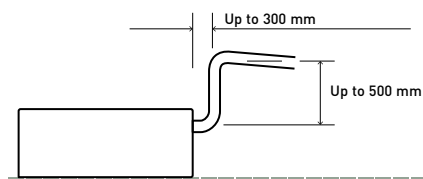

ECONAVI and INTERNET CONTROL: Optional.

## E2 type high static pressure hide-away · R410A

### High pressure duct and 100% fresh air duct function.

The E2 range of ducted units offers improved design flexibility for extended duct layouts as a result of their increased external static pressures whilst reducing energy consumption.



+ COMPATIBLE WITH ALL PANASONIC CONNECTIVITY SOLUTIONS. FOR DETAILED INFORMATION GO TO THE CONTROL SYSTEMS SECTION

Type	100% fresh air duct function (by using kit for 100% fresh air)				High pressure duct				
	Indoor unit	S-224ME2E5		S-280ME2E5		S-224ME2E5		S-280ME2E5	
		Cooling	Heating	Cooling	Heating	Cooling	Heating	Cooling	Heating
Capacity	kW	22,4	21,2	28,0	26,5	22,4	25,0	28,0	31,5
Input power	W	290,00	290,00	350,00	350,00	440,00	440,00	715,00	715,00
Current	A	1,85	1,85	2,20	2,20	2,45	2,45	3,95	3,95
Air flow	Hi/Med/Lo	m <sup>3</sup> /min		m <sup>3</sup> /min		m <sup>3</sup> /min		m <sup>3</sup> /min	
		28,3/—/—		35,0/—/—		56,0/51,0/44,0		72,0/63,0/53,0	
External static pressure	Pa	200		200		140(60-270) <sup>1)</sup>		140(72-270) <sup>1)</sup>	
Sound pressure <sup>2)</sup>	Hi/Med/Lo	dB(A)		dB(A)		dB(A)		dB(A)	
		43/—/—		44/—/—		45/43/41		49/47/43	
Sound power	Hi/Med/Lo	dB(A)		dB(A)		dB(A)		dB(A)	
		75/—/—		76/—/—		77/75/73		81/79/75	
Dimension	H x W x D	mm		mm		mm		mm	
		479 x 1453 x 1205		479 x 1453 x 1205		479 x 1453 x 1205		479 x 1453 x 1205	
Net weight	kg	102		106		102		106	
Piping diameter	Liquid	Inch (mm)		Inch (mm)		Inch (mm)		Inch (mm)	
	Gas	3/8(9,52)		3/8(9,52)		3/8(9,52)		3/8(9,52)	
		3/4(19,05)		7/8(22,22)		3/4(19,05)		7/8(22,22)	

Rating conditions for 100% fresh air duct function: Cooling outdoor 33 °C DB / 28 °C WB. Heating outdoor 0 °C DB / -2,9 °C WB.

1) Available to select the setting by initial setup. 2) Values with 140 Pa setting. \* No filter included. \*\* No compatible with 3-Pipe ECO G GF3.

#### Accessories

<b>CZ-RTC6W</b>	CONEX wired remote controller (non-wireless), white
<b>CZ-RTC6WBL</b>	CONEX wired remote controller with Bluetooth®, white
<b>CZ-RTC6</b>	CONEX wired remote controller (non-wireless), black
<b>CZ-RTC6BL</b>	CONEX wired remote controller with Bluetooth®, black
<b>CZ-RTC5B</b>	Wired remote controller with Econavi function
<b>CZ-RWS3 + CZ-RWRC3</b>	Infrared remote controller and receiver

#### Accessories

<b>PAW-RE2C4-MOD-WH</b>	Room controller for hotel rooms, white
<b>PAW-RE2C4-MOD-BK</b>	Room controller for hotel rooms, black
<b>PAW-RE2D4-WH</b>	Display control for hotel rooms, white
<b>PAW-RE2D4-BK</b>	Display control for hotel rooms, black
<b>CZ-CENSC1</b>	Econavi energy saving sensor

### Technical focus

- No need of rap valves for standard operation
- 100% fresh air duct function\*
- DC fan motor for more savings
- Complete flexibility for ductwork design
- Can be located within a weatherproof housing for external installation
- Air OFF sensor avoids cold air dumping
- Configurable air temperature control

\* Rap valves required, see 100% fresh air duct function below.

### 100% fresh air duct function

The E2 duct with 100% fresh air duct function have exceptional discharge temperature.

	Discharge Range		
	Min	Max	Default
Cooling	15 °C	24 °C	18 °C
Heating	17 °C	45 °C	40 °C

### System example

An inspection port (450 x 450 mm or more) is required at the lower side of the indoor unit body (field supply).

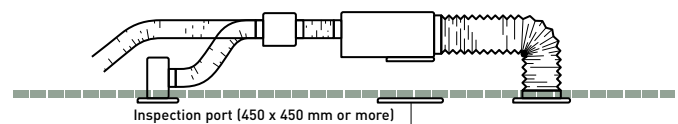

### Plenums

Air outlet plenum (suitable for rigid + flexible duct)		
	Number of exits with diameters	Model
S-224ME2E5	1 x 500 mm	CZ-TREMIESPW705
S-280ME2E5	1 x 500 mm	CZ-TREMIESPW706

### Kit for 100% fresh air function

Kit for 2 way systems		Kit for 3 way systems	
<b>2x CZ-P160RVK2</b>	Rap valve kit	<b>2x CZ-P160HR3</b>	3 way valve kit
<b>2x CZ-CAPE2</b>	3 way control PCB	<b>2x CZ-CAPE2</b>	3 way control PCB
<b>CZ-P680BK2BM</b>	Distribution joint kit	<b>CZ-P680BH2BM</b>	Distribution joint kit
	1x remote controller		1x remote controller



ECONAVI and INTERNET CONTROL: Optional.

Rating conditions: Cooling indoor 27 °C DB / 19 °C WB. Cooling outdoor 35 °C DB / 24 °C WB. Heating indoor 20 °C DB. Heating outdoor 7 °C DB / 6 °C WB. (DB: Dry Bulb, WB: Wet Bulb). Specifications subject to change without notice. For detailed information about ErP / Energy Labelling, please visit our websites [www.aircon.panasonic.eu](http://www.aircon.panasonic.eu) or [www.ptc.panasonic.eu](http://www.ptc.panasonic.eu).

## New wall-mounted with nanoe X Generator Mark 3

The K3 wall-mounted unit features the upgraded nanoe™ X (Generator Mark 3).



Modern design for any interior. Its modern, flat design with a stylish matte white finish suits any interior, perfect for commercial projects.

**Air distribution is automatically altered depending on the operational mode of the unit**

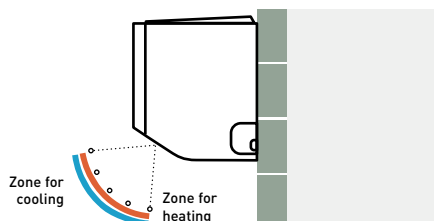

**Piping outlet in six directions**

Piping outlet is possible in six directions of; right, right rear, right bottom, left, left rear and left bottom, making the installation work more flexible.

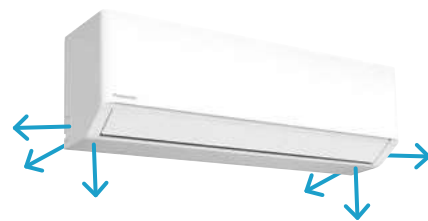

## NEW K3 type wall-mounted · R32 / R410A

### Equipped with the upgraded nanoe™ X (Generator Mark 3) for improved indoor air quality.

It's modern, flat design with a stylish matte white finish complements any interior, while improved fan serviceability ensures effortless maintenance.



+ COMPATIBLE WITH ALL PANASONIC CONNECTIVITY SOLUTIONS. FOR DETAILED INFORMATION GO TO THE CONTROL SYSTEMS SECTION

Indoor unit			S-15MK3E	S-22MK3E	S-28MK3E	S-36MK3E	S-45MK3E	S-56MK3E	S-73MK3E	S-106MK3E
Cooling capacity	kW		1,5	2,2	2,8	3,6	4,5	5,6	7,3	10,6
Input power	W		15,00	18,00	19,00	20,00	25,00	40,00	55,00	80,00
Current	A		0,18	0,19	0,20	0,22	0,25	0,35	0,50	0,70
Heating capacity	kW		1,7	2,5	3,2	4,2	5,0	6,3	8,0	10,6
Input power	W		15,00	18,00	19,00	20,00	25,00	40,00	55,00	80,00
Current	A		0,18	0,19	0,20	0,22	0,25	0,35	0,50	0,70
Fan type			Cross flow	Cross flow	Cross flow	Cross flow	Cross flow	Cross flow	Cross flow	Cross flow
Air flow	Cool (Hi/Med/Lo)	m <sup>3</sup> /min	6,8/6,3/5,5	9,0/8,0/7,0	9,5/8,5/7,0	10,5/9,0/7,5	11,5/10,0/7,5	15,0/14,0/13,0	19,0/17,0/14,0	22,0/18,0/14,0
	Heat (Hi/Med/Lo)	m <sup>3</sup> /min	6,8/6,3/5,5	9,0/8,0/7,0	10,0/8,5/7,0	10,5/9,0/7,5	11,5/10,0/7,5	15,0/14,0/13,0	19,0/17,0/14,0	22,0/18,0/14,0
Sound pressure	Hi/Med/Lo	dB(A)	31/29/28	32/30/29	33/31/29	35/32/29	38/33/29	40/38/35	47/44/40	50/45/40
Sound power	Hi/Med/Lo	dB(A)	46/44/43	47/45/44	48/46/44	50/47/44	53/48/44	55/53/50	62/59/55	65/60/55
Dimension	HxWxD	mm	295x890x244	295x890x244	295x890x244	295x890x244	295x890x244	295x1060x249	295x1060x249	295x1060x249
Net weight		kg	12	12	12	12	12	14	14	14
Piping diameter	Liquid	Inch (mm)	1/4 (6,35)	1/4 (6,35)	1/4 (6,35)	1/4 (6,35)	1/4 (6,35)	1/4 (6,35)	3/8 (9,52) <sup>1)</sup>	3/8 (9,52)
	Gas	Inch (mm)	1/2 (12,70)	1/2 (12,70)	1/2 (12,70)	1/2 (12,70)	1/2 (12,70)	1/2 (12,70)	5/8 (15,88) <sup>1)</sup>	5/8 (15,88)

1) When the piping diameter is (liquid) Ø1/4 (6,35) - (gas) Ø1/2 (12,70), connect the liquid socket tube (Ø1/4 (6,35) - Ø3/8 (9,52)) to the liquid tubing side indoor unit and connect the gas socket tube (Ø1/2 (12,70) - Ø5/8 (15,88)) to the gas tubing side indoor unit. \* Available in summer 2025.

#### Accessories

<b>CZ-RTC6W</b>	CONEX wired remote controller (non-wireless), white
<b>CZ-RTC6WBL</b>	CONEX wired remote controller with Bluetooth®, white
<b>CZ-RTC6WBLW2</b>	CONEX wired remote controller with Wi-Fi and Bluetooth®, white
<b>CZ-RTC6</b>	CONEX wired remote controller (non-wireless), black
<b>CZ-RTC6BL</b>	CONEX wired remote controller with Bluetooth®, black
<b>CZ-RTC6BLW2</b>	CONEX wired remote controller with Wi-Fi and Bluetooth®, black
<b>CZ-RTC5B</b>	Wired remote controller with Econavi function
<b>CZ-RWS3</b>	Infrared remote controller

#### Accessories

<b>PAW-RE2C4-MOD-WH</b>	Room controller for hotel rooms, white
<b>PAW-RE2C4-MOD-BK</b>	Room controller for hotel rooms, black
<b>PAW-RE2D4-WH</b>	Display control for hotel rooms, white
<b>PAW-RE2D4-BK</b>	Display control for hotel rooms, black
<b>CZ-CENSC1</b>	Econavi energy saving sensor
<b>CZ-P73SVK3</b>	External valve for model sizes 15 to 73*
<b>CZ-P106SVK3</b>	External valve for model size 106
<b>CZ-CGLSC2</b>	Panasonic R32 refrigerant leak detector

### Technical focus

- Modern, flat design with a stylish matte white finish
- Quiet operation
- nanoe™ X (Generator Mark 3: 48 trillion hydroxyl radicals/sec) as standard
- Easy fan, front grill, and blow-off grill removal for easy maintenance
- Efficient installation with drain hose support holders and lock mechanism
- Piping outlet in six directions
- Air distribution is automatically altered depending on the operational mode

### External valve (optional)

CZ-P73SVK3 (model sizes 15 to 73\*).  
CZ-P106SVK3 (model size 106).

\* A 3/8" to 1/4" reducer is required when combining the S-73MK3E with ECOi EX R410A outdoor units (ME2 and MF3).



### Efficient installation with drain hose support holders and lock mechanism

**Easy connection and disconnection of the drain hose.**  
Locking mechanism between the drain tray and hose ensures a tight connection during installation and easy dismantling.



**Built-in support holders for secure spacing.**  
Holds the indoor unit against the wall, providing clear access for setting up the drain hose and piping.



ECONAVI and INTERNET CONTROL: Optional.

Rating conditions: Cooling indoor 27 °C DB / 19 °C WB. Cooling outdoor 35 °C DB / 24 °C WB. Heating indoor 20 °C DB. Heating outdoor 7 °C DB / 6 °C WB. (DB: Dry Bulb; WB: Wet Bulb). Specifications subject to change without notice. For detailed information about ErP / Energy Labelling, please visit our websites [www.aircon.panasonic.eu](http://www.aircon.panasonic.eu) or [www.ptc.panasonic.eu](http://www.ptc.panasonic.eu).

## T2 type ceiling · R410A

The T2 type ceiling mounted units feature a DC fan motor for increased efficiency and reduced operating sound levels.

All the units are the same height and depth for a uniform appearance in mixed installations, and feature a fresh air knockout for improved air quality.



+ COMPATIBLE WITH ALL PANASONIC CONNECTIVITY SOLUTIONS. FOR DETAILED INFORMATION GO TO THE CONTROL SYSTEMS SECTION

Indoor unit		S-36MT2E5A	S-45MT2E5A	S-56MT2E5A	S-73MT2E5A	S-106MT2E5A	S-140MT2E5A	
Cooling capacity	kW	3,6	4,5	5,6	7,3	10,6	14,0	
Input power	W	35,00	40,00	40,00	55,00	80,00	100,00	
Current	A	0,36	0,38	0,38	0,44	0,67	0,79	
Heating capacity	kW	4,2	5,0	6,3	8,0	11,4	16,0	
Input power	W	35,00	40,00	40,00	55,00	80,00	100,00	
Current	A	0,36	0,38	0,38	0,44	0,67	0,79	
Fan type		Sirocco fan	Sirocco fan	Sirocco fan	Sirocco fan	Sirocco fan	Sirocco fan	
Air flow	Hi/Med/Lo	m <sup>3</sup> /min	14,0/12,0/10,5	15,0/12,5/10,5	15,0/12,5/10,5	21,0/18,0/15,5	30,0/25,0/23,0	32,0/28,0/24,0
Sound pressure	Hi/Med/Lo	dB(A)	36/32/30	37/33/30	37/33/30	39/35/33	42/37/36	46/40/37
Sound power	Hi/Med/Lo	dB(A)	54/50/48	55/51/48	55/51/48	57/53/51	60/55/54	62/58/55
Dimension	H x W x D	mm	235 x 960 x 690	235 x 960 x 690	235 x 960 x 690	235 x 1275 x 690	235 x 1590 x 690	235 x 1590 x 690
Net weight		kg	27	27	27	33	40	40
Piping diameter	Liquid	Inch (mm)	1/4 (6,35)	1/4 (6,35)	1/4 (6,35)	3/8 (9,52)	3/8 (9,52)	3/8 (9,52)
	Gas	Inch (mm)	1/2 (12,70)	1/2 (12,70)	1/2 (12,70)	5/8 (15,88)	5/8 (15,88)	5/8 (15,88)

### Accessories

<b>CZ-RTC6W</b>	CONEX wired remote controller (non-wireless), white
<b>CZ-RTC6WBL</b>	CONEX wired remote controller with Bluetooth®, white
<b>CZ-RTC6</b>	CONEX wired remote controller (non-wireless), black
<b>CZ-RTC6BL</b>	CONEX wired remote controller with Bluetooth®, black
<b>CZ-RTC5B</b>	Wired remote controller with Econavi function
<b>CZ-RWS3 + CZ-RWRT3</b>	Infrared remote controller and receiver

### Accessories

<b>PAW-RE2C4-MOD-WH</b>	Room controller for hotel rooms, white
<b>PAW-RE2C4-MOD-BK</b>	Room controller for hotel rooms, black
<b>PAW-RE2D4-WH</b>	Display control for hotel rooms, white
<b>PAW-RE2D4-BK</b>	Display control for hotel rooms, black
<b>CZ-CENSC1</b>	Econavi energy saving sensor

### Technical focus

- Low sound levels
- All units just 235 mm high
- Large and wide air distribution
- Easy to install and maintain
- Fresh air knockout

### Air distribution is altered depending on the operational mode

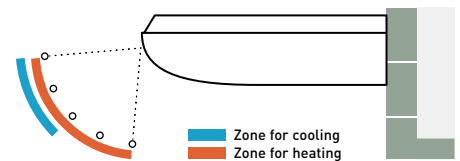

### Further comfort improvement with air flow distribution

Horizontal air flow reaches maximum 9,5 m. This is ideal for wide rooms.

The wide air discharge opening expands the air flow to the left and right. The unpleasant feeling caused when the air flow directly hits the human body is prevented by the "Draft prevention position", which changes the swing width, increasing the degree of comfort.

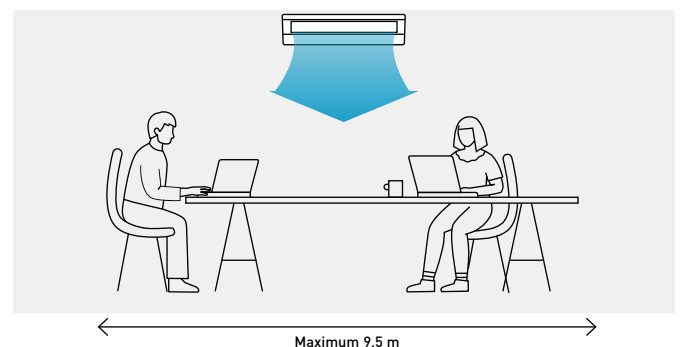

ECONAVI and INTERNET CONTROL: Optional.



## G1 type floor console - R410A

The stylish and compact unit profile, also used for residential market range, is easy to integrate into any design of building.

Compact and versatile, this system is capable of being installed in an area with limited space. It is a perfect solution for retrofit, replacing existing radiator panels.



+ COMPATIBLE WITH ALL PANASONIC CONNECTIVITY SOLUTIONS. FOR DETAILED INFORMATION GO TO THE CONTROL SYSTEMS SECTION

Indoor unit			S-22MG1E5N	S-28MG1E5N	S-36MG1E5N	S-45MG1E5N	S-56MG1E5N
Cooling capacity	kW		2,2	2,8	3,6	4,5	5,6
Input power	W		20,00	20,00	22,00	28,00	31,00
Current	A		0,20	0,20	0,23	0,25	0,28
Heating capacity	kW		2,5	3,2	4,2	5,0	6,3
Input power	W		21,00	21,00	23,00	29,00	32,00
Current	A		0,20	0,20	0,24	0,26	0,28
Fan type			Cross flow	Cross flow	Cross flow	Cross flow	Cross flow
nanoe X Generator			Mark 1	Mark 1	Mark 1	Mark 1	Mark 1
Air flow	Cool (Hi/Med/Lo)	m <sup>3</sup> /min	9,2/7,5/6,0	9,2/7,5/6,0	9,7/8,2/6,0	10,5/9,0/6,5	12,0/9,5/6,5
	Heat (Hi/Med/Lo)	m <sup>3</sup> /min	9,7/8,0/6,5	9,7/8,0/6,5	10,2/8,7/6,5	11,0/9,5/7,0	12,5/10,0/7,0
Sound pressure	Hi/Med/Lo	dB(A)	38/34/29	38/34/29	39/35/29	42/37/30	44/38/30
Dimension	H x W x D	mm	600 x 750 x 207	600 x 750 x 207	600 x 750 x 207	600 x 750 x 207	600 x 750 x 207
Net weight		kg	14	14	14	14	14
Piping diameter	Liquid	Inch (mm)	1/4 (6,35)	1/4 (6,35)	1/4 (6,35)	1/4 (6,35)	1/4 (6,35)
	Gas	Inch (mm)	1/2 (12,70)	1/2 (12,70)	1/2 (12,70)	1/2 (12,70)	1/2 (12,70)

\* Infrared receiver is integrated with the unit as standard.

### Accessories

<b>CZ-RTC6W</b>	CONEX wired remote controller (non-wireless), white
<b>CZ-RTC6WBL</b>	CONEX wired remote controller with Bluetooth®, white
<b>CZ-RTC6</b>	CONEX wired remote controller (non-wireless), black
<b>CZ-RTC6BL</b>	CONEX wired remote controller with Bluetooth®, black
<b>CZ-RTC5B</b>	Wired remote controller with Econavi function
<b>CZ-RWS3*</b>	Infrared remote controller

### Accessories

<b>PAW-RE2C4-MOD-WH</b>	Room controller for hotel rooms, white
<b>PAW-RE2C4-MOD-BK</b>	Room controller for hotel rooms, black
<b>PAW-RE2D4-WH</b>	Display control for hotel rooms, white
<b>PAW-RE2D4-BK</b>	Display control for hotel rooms, black
<b>CZ-CENSC1</b>	Econavi energy saving sensor

## 1 nanoe™ X: Bringing nature's balance indoors

Panasonic's nanoe™ X technology brings nature's detergent – hydroxyl radicals – indoors to help improve protection 24/7 against several types of pollutants can be inhibited such as certain types of bacteria, viruses, mould, allergens, pollen or hazardous substances.

## 2 Stylish and simple

- Clean and modern European design with slim depth
- Modern matt white color panel
- Washable air filter

The stylish and compact unit profile, also used for residential market range, is easy to integrate into any design of building.



**Dimension:**  
W x H x D = 750 x 600 x 207 mm

**Weight:**  
14kg

## 3 Flexible easy installation

Four different mounting styles possible: exposed (floor or wall), semi-recessed and recessed.

Flexible installation with 4 different options.

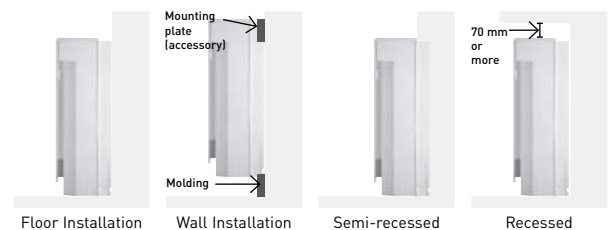

## 4 Functions for comfort

- Double Air Flow direction to maximize comfort
- Self-cleaning function
- Compatible with Commercial Wi-Fi Adaptor for cloud control

### Self-cleaning function.

- Self cleaning function can be pre-scheduled with remote controller, up to a maximum of 90 minutes following cooling / dry operation
- Air flow will not blow directly at occupants during self-cleaning



ECONAVI and INTERNET CONTROL: Optional.

Rating conditions: Cooling indoor 27 °C DB / 19 °C WB. Cooling outdoor 35 °C DB / 24 °C WB. Heating indoor 20 °C DB. Heating outdoor 7 °C DB / 6 °C WB. (DB: Dry Bulb; WB: Wet Bulb). Specifications subject to change without notice. For detailed information about ErP / Energy Labelling, please visit our websites [www.aircon.panasonic.eu](http://www.aircon.panasonic.eu) or [www.ptc.panasonic.eu](http://www.ptc.panasonic.eu).

**P1 type floor-standing · R410A**

The compact floor-standing P1 units are the ideal solution for providing perimeter air conditioning.

**R1 type concealed floor-standing · R410A**

At just 229 mm deep, the R1 unit can be easily concealed in perimeter areas to provide powerful and effective air conditioning.



+ COMPATIBLE WITH ALL PANASONIC CONNECTIVITY SOLUTIONS. FOR DETAILED INFORMATION GO TO THE CONTROL SYSTEMS SECTION

P1 indoor unit		S-22MP1E5	S-28MP1E5	S-36MP1E5	S-45MP1E5	S-56MP1E5	S-71MP1E5	
R1 indoor unit		S-22MR1E5	S-28MR1E5	S-36MR1E5	S-45MR1E5	S-56MR1E5	S-71MR1E5	
Cooling capacity	kW	2,2	2,8	3,6	4,5	5,6	7,1	
Input power	W	56,00	56,00	85,00	126,00	126,00	160,00	
Current	A	0,25	0,25	0,38	0,56	0,56	0,72	
Heating capacity	kW	2,5	3,2	4,2	5,0	6,3	8,0	
Input power	W	40,00	40,00	70,00	91,00	91,00	120,00	
Current	A	0,18	0,18	0,31	0,41	0,41	0,54	
Fan type		Sirocco fan	Sirocco fan	Sirocco fan	Sirocco fan	Sirocco fan	Sirocco fan	
Air flow	Hi/Med/Lo	m <sup>3</sup> /min	7,0/6,0/5,0	7,0/6,0/5,0	9,0/7,0/6,0	12,0/9,0/8,0	15,0/13,0/11,0	17,0/14,0/12,0
External static pressure		Pa	15	15	15	15	15	
Sound pressure	Hi/Med/Lo	dB(A)	33/30/28	33/30/28	39/35/29	38/35/31	39/36/31	41/38/35
P1 dimension	HxWxD	mm	615x1065x230	615x1065x230	615x1065x230	615x1380x230	615x1380x230	
P1 net weight		kg	29	29	29	39	39	
R1 dimension	HxWxD	mm	616x904x229	616x904x229	616x904x229	616x1219x229	616x1219x229	
R1 net weight		kg	21	21	21	28	28	
Piping diameter	Liquid	Inch (mm)	1/4 (6,35)	1/4 (6,35)	1/4 (6,35)	1/4 (6,35)	1/4 (6,35)	3/8 (9,52)
	Gas	Inch (mm)	1/2 (12,70)	1/2 (12,70)	1/2 (12,70)	1/2 (12,70)	1/2 (12,70)	5/8 (15,88)

**Accessories**

<b>CZ-RTC6W</b>	CONEX wired remote controller (non-wireless), white
<b>CZ-RTC6WBL</b>	CONEX wired remote controller with Bluetooth®, white
<b>CZ-RTC6</b>	CONEX wired remote controller (non-wireless), black
<b>CZ-RTC6BL</b>	CONEX wired remote controller with Bluetooth®, black
<b>CZ-RTC5B</b>	Wired remote controller with Econavi function

**Accessories**

<b>CZ-RWS3 + CZ-RWRC3</b>	Infrared remote controller and receiver
<b>PAW-RE2C4-MOD-WH</b>	Room controller for hotel rooms, white
<b>PAW-RE2C4-MOD-BK</b>	Room controller for hotel rooms, black
<b>PAW-RE2D4-WH</b>	Display control for hotel rooms, white
<b>PAW-RE2D4-BK</b>	Display control for hotel rooms, black

**P1 Technical focus**

- Pipes can be connected to either side of the unit from the bottom or rear
- Easy to install
- Front panel opens fully for easy maintenance
- Removable air discharge grille gives flexible air flow
- Room for condensate pump

**R1 technical focus**

- Chassis unit for discreet installation
- Complete with removable filters
- Pipes can be connected to either side of the unit from the bottom or rear
- Easy to install

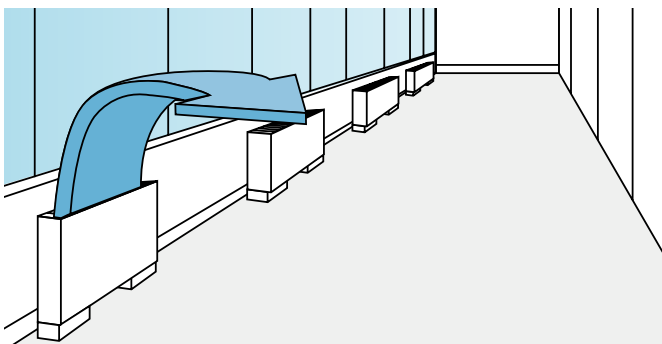
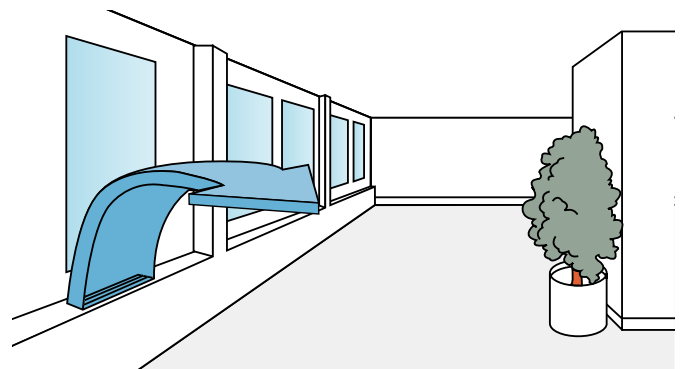
**Effective perimeter handling****Perimeter air conditioning with high interior quality**

INTERNET CONTROL: Optional.

## Hydrokit for ECOi, water at 45 °C · R410A

### Connect the Hydrokit to your VRF system, together with other indoor units.

Total system performs high energy efficiency through heat recovering operation, and it gives an advantage for sustainability related assessment methods, such as BREEAM in UK.



+ COMPATIBLE WITH ALL PANASONIC CONNECTIVITY SOLUTIONS. FOR DETAILED INFORMATION GO TO THE CONTROL SYSTEMS SECTION

Indoor unit				S-80MW1E5	S-125MW1E5
Power supply	Voltage	V		230	230
	Phase			Single phase	Single phase
	Frequency	Hz		50	50
Cooling capacity	kW		8,0	12,5	
Heating capacity	kW		9,0	14,0	
Maximum temperature	°C		-45 / -65 <sup>1)</sup>	-45 / -65 <sup>1)</sup>	
Dimension	H x W x D	mm		892 x 502 x 353	892 x 502 x 353
Water pipe connector			Inch		R 1 ¼
Water pump (built-in)					DC motor (A class)
Water flow rate	Cool	L/min		22,90	35,80
	Heat	L/min		25,80	40,10
Piping diameter	Liquid	Inch (mm)		3/8 (9,52)	3/8 (9,52)
	Gas	Inch (mm)		5/8 (15,88)	5/8 (15,88)
	Drain	mm		15 ~ 17 (inner size)	15 ~ 17 (inner size)
Operation range	Cool	Ambient	°C	+10 ~ +43	+10 ~ +43
		Water	°C	+5 ~ +20	+5 ~ +20
	Heat	Ambient	°C	-20 ~ +43	-20 ~ +43
		Water	°C	+25 ~ +45	+25 ~ +45
Connectable system	3-Pipe (heat recovery type) VRF System (system capable up to 48 HP)				
Maximum indoor ratio (connectable hydrokit module capacity ratio)	Total indoor unit + Hydrokit capacity: up to 130% (** ~ **% vs total outdoor unit capacity)				

1) Maximum 45 °C by refrigerant circuit (heat pump cycle), over 45 °C is provided by electric heater operation.

#### Accessories

**CZ-RTC5B** Wired remote controller with Econavi function

### Basic principle and advantage.

Hydrokit module provides hot water by using waste heat that is recovered from standard air-conditioning indoor unit in cooling mode.

### Technical focus

- Only with 3-Pipe ECOi EX MF3 Series outdoor units
- Remote controller CZ-RTC5B common use with DX coil indoor units PACi and ECOi

### Hydrokit control function / CZ-RTC5B

- CZ-RTC5B can be used for hydrokit and also normal indoor unit. CZ-RTC5B checks the type of connected unit and switches between hydrokit and air conditioner display automatically

- Hydrokit mode (tank or air conditioning mode) is set during initial startup

### Overview: hydromodule in VRF system

- Multiple hydromodule connection in same circuit is available
- The mode of each module can be individually set from either hot water or space heating / cooling (once set the units cannot operate in another mode, resetting will be required)
- 3-Pipe control solenoid valve kit is necessary for each indoor unit and hydromodule

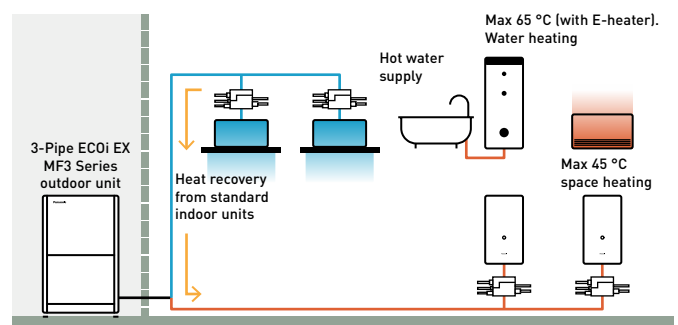

\* Cold water also available.

# New HT Booster for ECOi EX Series

Hydraulic module solution for high-temperature heating applications, ideal for boiler replacements.



Maximum water outlet temperature of 70 °C.



R290 cascade system for high-temperature hot water.



Priority mode selectable for hot water or space heating.

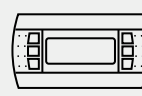

Smart logic built-in controller.



Direct BMS integration.

## Overview: HT Booster in VRF system

- Multiple HT Boosters can be connected within the same system circuit
- Hot water or space heating mode can be set via HT Booster
- A 3 way water valve (field supplied) is required for the HT Booster if both DHW and space heating are needed. For DHW or space heating alone, no valve is required
- A 3-Pipe control solenoid valve kit is required for each indoor unit and HT Booster in the case of 3-Pipe ECOi EX system

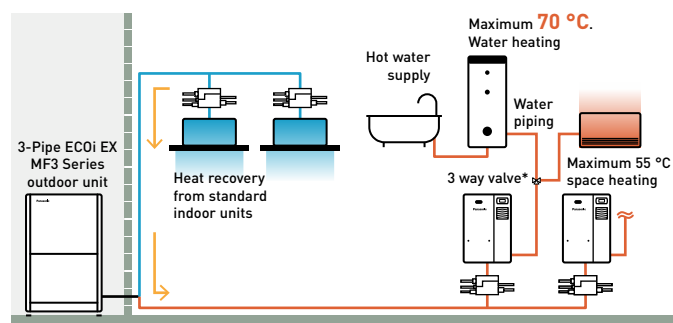

\* Field supplied.

## NEW HT Booster for ECOi EX Series, water at 70 °C · R410A

Contributes to building decarbonisation through heat recovery operation.

New  
2025



Indoor unit			P-250WXHT1E5
Power supply	Voltage	V	400
	Phase		Three phase
	Frequency	Hz	50
	Maximum amperage	A	28
Heating capacity		kW	25,0 <sup>1)</sup>
Maximum temperature		°C	70
Dimension	H x W x D	mm	925 x 640 x 445
Water pipe connector		Inch	R 1 ½
Water pump (built-in)			Modulating / EC motor
Water flow rate	Nominal	L/min	73
	Liquid	Inch (mm)	3/8 (9,52)
Piping diameter	Gas	Inch (mm)	5/8 (15,88)
	Ambient	°C	+5 ~ +40
Indoor operating range	Water	°C	+35 ~ +70
	Ambient	°C	-25 ~ +52 <sup>2)</sup>
Connectable system			2-Pipe ECOi EX ME2 R410A 3-Pipe ECOi EX MF3 R410A (heat recovery type)
Maximum Indoor ratio (connectable hydrokit module capacity ratio)			Total indoor unit + HT Booster capacity: up to 130%

1) 25 kW heating capacity at 50 °C temperature, 20 kW heating capacity at 70 °C temperature. 2) Minimum operating temperature of -25 °C is considering connection with 2-Pipe ECOi EX ME2 or MZ1. For Mini ECOi or 3-Pipe ECOi EX MF3 the minimum operating range is -20 °C. For 3-Pipe ECOi EX operation, the available heating range is -25 °C to +24 °C, varying depending on the outdoor unit type.

\* Available in Autumn 2025.

### Technical focus

- Maximum water outlet temperature of 70 °C
- Cascade circuit system using R290 refrigerant for efficient high-temperature hot water production
- High-volume flow ensures rapid recovery and flexible installation options
- Integrated pump simplifies installation
- Built-in R290 sensor and safety ventilation compliant with IEC 60335-2-40 edition 7
- Built-in remote controller designed for straightforward programming and enhanced customisation
- Direct Modbus communication without requiring an additional interface
- Optimised control prioritising energy-saving performance, including heat recovery operation with the 3-Pipe ECOi EX outdoor unit
- Compatible with ECOi EX Series 2-Pipe (ME2) and 3-Pipe (MF3)
- Operates in ambient temperatures as low as -25 °C for heating and up to +52 °C for cooling with 2-Pipe ECOi EX outdoor unit.

### How the HT Booster works

Optimised cascade circuit system with R290 refrigerant efficiently delivers high-temperature hot water up to 70 °C, ensuring energy-saving performance and sustainability.

### Boosts hot water up to 70 °C

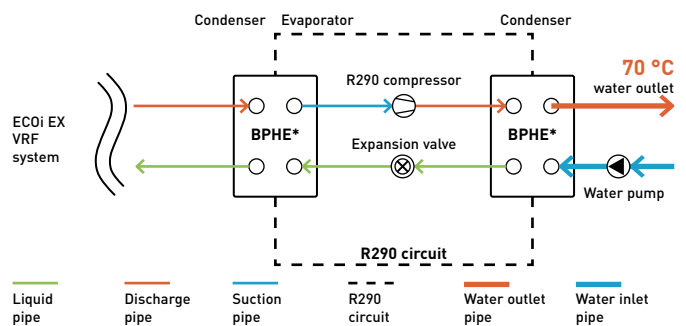

\* BPHE: Brazed plate heat exchanger.

## AHU connection kit MAH4M for ECOi 2-Pipe

Space-saving compact casing.  
Direct Modbus communication without the need for an additional interface.  
Accurate control with a pressure transducer.



Built-in controller.



PAW-P+100MAH4M			6 HP	12 HP	16 HP	18 HP	20 HP	22 HP	24 HP	34 HP <sup>1)</sup>
Cooling capacity	Nominal	kW	16,0	33,5	45,0	50,0	56,0	61,5	68,0	96,0
Heating capacity	Nominal	kW	17,0	37,5	50,0	56,0	63,0	69,0	76,5	108,0
Air flow	Min / Max	m <sup>3</sup> /h	1800 / 4400	2000 / 10000	3500 / 12000	5000 / 20000	5000 / 20000	5000 / 20000	6000 / 24000	8500 / 32000
Dimension	H x W x D	mm	300 x 400 x 150	300 x 400 x 150	300 x 400 x 150	300 x 400 x 150	300 x 400 x 150	300 x 400 x 150	300 x 400 x 150	300 x 400 x 150
Weight		kg	11	11	11	11	11	11	11	11
Pipe length range		m	10 ~ 100	10 ~ 100	10 ~ 100	10 ~ 100	10 ~ 100	10 ~ 100	10 ~ 100	10 ~ 100
Elevation difference (in / out)		m	10	10	10	10	10	10	10	10
Piping diameter ≤ 90 m	Liquid	Inch (mm)	3/8 (9,52)	1/2 (12,70)	1/2 (12,70)	5/8 (15,88)	5/8 (15,88)	5/8 (15,88)	5/8 (15,88)	3/4 (19,05)
	Gas	Inch (mm)	5/8 (15,88)	1 (25,40)	1 1/8 (28,57)	1 1/8 (28,57)	1 1/8 (28,57)	1 1/8 (28,57)	1 1/8 (28,57)	1 1/4 (31,75)
Piping diameter > 90 m <sup>2)</sup>	Liquid	Inch (mm)	—	5/8 (15,88)	5/8 (15,88)	3/4 (19,05)	3/4 (19,05)	3/4 (19,05)	3/4 (19,05)	7/8 (22,22)
	Gas	Inch (mm)	—	1 1/8 (28,57)	1 1/4 (31,75)	1-1/4 (31,75)	1 1/4 (31,75)	1 1/4 (31,75)	1 1/4 (31,75)	1 1/2 (38,10)

1) High-efficiency combination: U-10ME2E8 + 2xU-12ME2E8. 2) For R410A models only.

### AHU connection kit / system combination

Cooling capacity	Mini VRF		2-Pipe VRF		AHU connection kit	EEV pack
	Mini ECOi LZ2 Series (R32)	Mini ECOi LE Series (R410A)	ECOi EX ME2 Series			
4 ~ 6 HP	U-4LZ2E5(8) / U-5LZ2E5(8) / U-6LZ2E5(8)	U-4LE2E5(8) / U-5LE2E5(8) / U-6LE2E5(8)	—	—	PAW-P+100MAH4M	PAW-P+116EEVPACK
8 ~ 12 HP	U-8LZ2E8 / U-10LZ2E8	U-8LE1E8 / U-10LE1E8	U-8ME2E8 / U-10ME2E8 / U-12ME2E8	—	PAW-P+100MAH4M	PAW-P+133EEVPACK
14 ~ 18 HP	—	—	U-14ME2E8 / U-16ME2E8 / U-18ME2E8	—	PAW-P+100MAH4M	PAW-P+145EEVPACK
20 ~ 22 HP	—	—	20 HP (2xU-10ME2E8) 22 HP (U-10ME2E8 + U-12ME2E8)	—	PAW-P+100MAH4M	PAW-P+156EEVPACK
24 ~ 34 HP	—	—	24 HP (2xU-12ME2E8) 34 HP*	—	PAW-P+100MAH4M	PAW-P+174EEVPACK

\* Multiple combinations available.

### Accessories

<b>PAW-P+102SENSPACK</b>	AHU connection kit sensor pack 1 (2 pcs of SENSOR PT1000 HT IP67 -50/250 CABLE 6 m PCK)
<b>PAW-P+116EEVPACK</b>	EEV pack 1 (1 pc of expansion valve ≤ 16,0 kW (R410A / R32) and 1 pc of UNIPOLAR stator)
<b>PAW-P+133EEVPACK</b>	EEV pack 2 (1 pc of expansion valve ≤ 33,0 kW (R410A / R32) and 1 pc of UNIPOLAR stator)
<b>PAW-P+145EEVPACK</b>	EEV pack 3 (1 pc of expansion valve ≤ 45,0 kW (R410A / R32) and 1 pc of UNIPOLAR stator)

### Accessories

<b>PAW-P+156EEVPACK</b>	EEV pack 4 (1 pc of expansion valve ≤ 61,5 kW (R410A / R32) and 1 pc of UNIPOLAR stator)
<b>PAW-P+174EEVPACK</b>	EEV pack 5 (1 pc of expansion valve ≤ 96,0 kW (R410A / R32) and 1 pc of UNIPOLAR stator)
<b>PAW-P+100PGNEPACK</b>	Remote control pack (1 pc of PGNE 132 x 64 mm, mounting panel and 1 pc of cable L= 1,5 m, telephone connectors)

## Technical focus

- Maximum capacity / system: 34 HP (96 kW\*)
- Selectable expansion valve packs depending on the capacity
- DC 12 V outlet available without optional interface
- Maximum elevation difference indoor/outdoor unit: 10 m
- Elevation difference (indoor unit / indoor unit): 4 m
- In / out connection capacity ratio: 50~100%
- Maximum number of AHU connection kits: 1 unit
- Outdoor temperature range in heating: -20 ~ +15 °C
- Available temperature range for the suction air at AHU connection kit: cool: +18 ~ +32 °C / heat: +16 ~ +30 °C
- The system's set temperature can be selected either as the default setting discharge air temperature (supply room temperature) or the suction air set temperature (or room return air temperature)
- Accurate control with a pressure transducer
- Direct Modbus communication with a built-in Modbus S-Link interface
- Various technical parameters available with Modbus
- SG Ready fulfilled. Demand input can be set Thermostat OFF or 40 - 200% by the user

- Defrost operation signal, compressor status ON / OFF output
- Display an error message concerning drain water overflow
- Connectable with S-Link system. Special care for electrical noise may be necessary depending on the on-site system
- Fan control signal output to manage the air flow (ON / OFF)
- Alarm status monitoring output

\* Nominal cooling capacity.

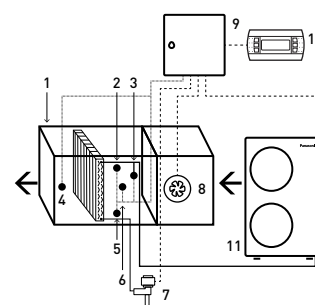

### System and regulations. System overview.

- 1 | AHU Unit equipment (field supplied)
- 2 | Thermistor for gas pipe (E3)
- 3 | Pressure transducer
- 4 | Thermistor for discharge air (BL)
- 5 | Thermistor for liquid pipe (E1)
- 6 | Thermistor for suction air (TA)
- 7 | Expansion valve (accessory part)
- 8 | Fan (field supplied)
- 9 | AHU connection kit controller box
- 10 | Optional remote controller
- 11 | Outdoor unit Mini ECOi and 2-Pipe ECOi EX

### AHU connection kit MAH3M for ECOi and ECO G

Available with ECOi and ECO G Series.  
CONEX Bluetooth® version [CZ-RTC6BL] is built-in.  
0-10 V demand control.



**CONEX**  
CONEX Bluetooth®  
control built-in.  
CZ-RTC6BL



ECO i EX / ECO i / ECO G

Model	PAW-	5 HP	10 HP	20 HP	30 HP	40 HP	50 HP	60 HP	70 HP	80 HP
		160MAH3M	280MAH3M	560MAH3M	280MAH3M 560MAH3M	560MAH3M	560MAH3M 280MAH3M	560MAH3M 560MAH3M	560MAH3M 560MAH3M	560MAH3M 280MAH3M
Cooling capacity	kW	14,0	28,0	56,0	84,0	112,0	140,0	168,0	196,0	224,0
Heating capacity	kW	16,0	31,5	63,0	95,0	127,0	155,0	189,0	219,0	252,0
Air flow	Cool Min/Max m³/h	1140/2598	3498/4998	7002/10002	10500/15000	13998/19998	17496/24996	21000/30000	35000/24000	40000/28000
Bypass factor recommended		0,9	0,9	0,9	0,9	0,9	0,9	0,9	0,9	0,9
Dimension	HxWxD mm	500x400 x150	500x400 x150	500x400 x150	500x400 x150*	500x400 x150*	500x400 x150*	500x400 x150*	500x400 x150*	500x400 x150*
Net weight	kg	11,5	11,5	11,5	11,5*	11,5*	11,5*	11,5*	11,5*	11,5*
Pipe length range	m	10~100	10~100	10~100	10~100	10~100	10~100	10~100	10~100	10~100
Elevation difference (in / out)	Max m	10	10	10	10	10	10	10	10	10
Piping diameter	Liquid Inch (mm)	3/8(9,52)	3/8(9,52)	5/8(15,88)	3/4(19,05)	3/4(19,05)	3/4(19,05)	3/4(19,05)	7/8(22,22)	7/8(22,22)
	Gas Inch (mm)	5/8(15,88)	7/8(22,22)	1 1/8(28,58)	1 1/4(31,75)	1 1/2(38,15)	1 1/2(38,15)	1 1/2(38,15)	1 5/8(41,28)	1 3/4(44,45)
Intake temperature of AHU connection kit	Cool Min ~ Max °C DB	+18 ~ +32	+18 ~ +32	+18 ~ +32	+18 ~ +32	+18 ~ +32	+18 ~ +32	+18 ~ +32	+18 ~ +32	+18 ~ +32
	Cool Min ~ Max °C WB	+13 ~ +23	+13 ~ +23	+13 ~ +23	+13 ~ +23	+13 ~ +23	+13 ~ +23	+13 ~ +23	+13 ~ +23	+13 ~ +23
	Heat Min ~ Max °C	+16 ~ +30	+16 ~ +30	+16 ~ +30	+16 ~ +30	+16 ~ +30	+16 ~ +30	+16 ~ +30	+16 ~ +30	+16 ~ +30
Ambient temperature of outdoor unit	Cool Min ~ Max °C	-10 ~ +43	-10 ~ +43	-10 ~ +43	-10 ~ +43	-10 ~ +43	-10 ~ +43	-10 ~ +43	-10 ~ +43	-10 ~ +43
	Heat Min ~ Max °C	-20 ~ +15	-20 ~ +15	-20 ~ +15	-20 ~ +15	-20 ~ +15	-20 ~ +15	-20 ~ +15	-20 ~ +15	-20 ~ +15

\* The value applies to one unit of the AHU connection kit.

AHU connection kit / system combination						
Capacity	ECOi Series		AHU kit	Capacity	ECO G Series	AHU kit
5 HP 16 kW	Mini ECOi / ECOi EX ME2 Series		160MAH3M	5 HP 16 kW	All ECO G	160MAH3M
10 HP 28 kW	U-8LZ2E8/U-10LZ2E8/ U-8LE1E8/U-10LE1E8/ U-10ME2E8	—	280MAH3M	10 HP 28 kW	All ECO G	280MAH3M
	U-20ME2E8	—	560MAH3M			
30 HP 84 kW	U-16ME2E8	U-14ME2E8	560MAH3M 280MAH3M	20 HP 56 kW	U-20GE3E5	560MAH3M
40 HP 112 kW	U-20ME2E8	U-20ME2E8	560MAH3M 560MAH3M			
50 HP 140 kW	U-18ME2E8	U-16ME2E8	560MAH3M 560MAH3M 280MAH3M			
60 HP 168 kW	U-20ME2E8	U-20ME2E8	560MAH3M 560MAH3M 560MAH3M			
70 HP 196 kW	U-20ME2E8	U-20ME2E8	560MAH3M 560MAH3M 560MAH3M 280MAH3M			
80 HP 224 kW	U-20ME2E8	U-20ME2E8	560MAH3M 560MAH3M 560MAH3M 560MAH3M			

### Technical focus

- Maximum capacity / system: 80 HP (224 kW)
- Maximum piping length: 100 m (120 m equivalent)
- Elevation difference (indoor unit / indoor unit): 4 m
- In / out capacity ratio: 50~100%
- Maximum number of AHU connection kits: 4 units\*
- Outdoor temperature range in heating: -20 ~ +15 °C
- Available temperature range for the suction air at AHU connection kit: cool: +18 ~ +32 °C / heat: +16 ~ +30 °C
- The systems is controlled by the suction air (or room return air) temperature (same as standard indoor unit)
- The discharge air temperature is also controlled to prevent too-low air discharge in cooling or too-high air discharge in heating (in case of VRF)
- Demand control (forcible thermostat-OFF control by operating current)
- Defrost operation signal, Thermo-ON / OFF states output
- Drain pump control (drain pump and the float switch to be supplied in local)
- External target temperature setting via indoor / outdoor signal interface is available with CZ-CAPBC2 (Ex. 0-10 V)
- Demand control 40% to 120% (5% steps) by 0-10 V input signal
- Connectable with S-Link system. Special care for electrical noise may be necessary depending on the on-site system

- Fan control signal from the PCB can be used to control the air flow (high / mid / low and LL for Th-OFF). Need to change the fan control circuit wiring at field

\* To be simultaneous operation controlled by one remote controller sensor.

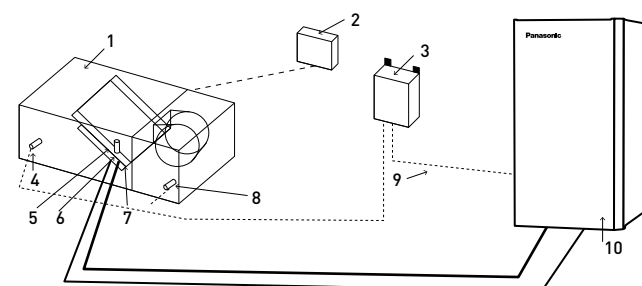

#### System and regulations. System overview.

- 1 | AHU Unit equipment (field supplied)
- 2 | AHU Unit system controller (field supplied)
- 3 | AHU connection kit controller box (with control PCB)
- 4 | Thermistor for discharge air
- 5 | Electronic expansion valve
- 6 | Thermistor for gas pipe [E3]
- 7 | Thermistor for liquid pipe [E1]
- 8 | Thermistor for suction air
- 9 | Inter-unit wiring
- 10 | ECOi or ECOi G outdoor unit

#### Optional controller.

Timer remote controller.  
CZ-RTC5B.



Advanced energy recovery ventilation - ZY Series

- Extended 9 model line-up including 2000 m<sup>3</sup>/h model
- DC motors
- ESP up to 150 Pa
- F7 grade filter built-in as a standard
- Intuitive remote controller
- BMS integration with RS485



Rated flow rate			150 m <sup>3</sup> /h	250 m <sup>3</sup> /h	350 m <sup>3</sup> /h	500 m <sup>3</sup> /h	650 m <sup>3</sup> /h	800 m <sup>3</sup> /h	1000 m <sup>3</sup> /h	1500 m <sup>3</sup> /h	2000 m <sup>3</sup> /h
<b>Indoor unit</b>			<b>FV-15ZY1G</b>	<b>FV-25ZY1G</b>	<b>FV-35ZY1G</b>	<b>FV-50ZY1G</b>	<b>FV-65ZY1G</b>	<b>FV-80ZY1G</b>	<b>FV-1KZY1G</b>	<b>FV-1HZY1G</b>	<b>FV-2KZY1G</b>
Power supply	Voltage	V	220 - 240	220 - 240	220 - 240	220 - 240	220 - 240	220 - 240	220 - 240	220 - 240	220 - 240
	Phase		Single phase	Single phase	Single phase	Single phase	Single phase	Single phase	Single phase	Single phase	Single phase
	Frequency	Hz	50	50	50	50	50	50	50	50	50
Motor type			DC	DC	DC	DC	DC	DC	DC	DC	DC
<b>ERV</b>											
Air flow	Max	m <sup>3</sup> /h	150	250	350	500	650	800	1000	1500	2000
External static pressure	Max	Pa	100	120	140	130	150	150	150	130	130
Sound power <sup>2)</sup>	Max	dB(A)	37	38	39	43	45	45	46	49	51
Input power	Max	W	76~84	106~117	141~155,5	180~198	420~462	470~517	550~605	940~1034	1100~1210
<b>Heat exchange efficiency <sup>3)</sup></b>											
Cooling	Max	%	68,0	69,0	71,0	65,0	64,0	63,0	65,0	63,0	65,0
Heating	Max	%	83,0	82,0	83,0	81,0	82,0	83,0	82,0	83,0	82,0
<b>Enthalpy exchange efficiency</b>											
Cooling	Max	%	66,0	66,0	67,0	62,5	62,5	63,5	63,0	63,5	63,0
Heating	Max	%	76,0	74,0	75,0	73,0	72,0	73,0	74,0	73,0	74,0
Adapter diameter		mm	100	150	150	200	200	250	250	250	250
Dimension	H x W x D	mm	289 x 610 x 860	289 x 735 x 860	331 x 874 x 968	331 x 1016 x 968	404 x 954 x 1008	404 x 1004 x 1224	404 x 1231 x 1224	808 x 1004 x 1224	808 x 1231 x 1224
Net weight		kg	23	27	37	40	48	60	64	119	142

1) Different dimensions depending on models. 2) Measurement of noise 1,5 m below the center of the main unit (anechoic chamber). 3) Heat exchange efficiency measurement standard JIS B 8628 (2003). \* JIS B 8628 (2017) is used in the measurement environment. \* A remote controller is included.

Accessories	
<b>FV-FP15ZY1G</b>	Replacement high efficiency filter for FV-15ZY1G
<b>FV-FP25ZY1G</b>	Replacement high efficiency filter for FV-25ZY1G
<b>FV-FP35ZY1G</b>	Replacement high efficiency filter for FV-35ZY1G
<b>FV-FP50ZY1G</b>	Replacement high efficiency filter for FV-50ZY1G

Accessories	
<b>FV-FP65ZY1G</b>	Replacement high efficiency filter for FV-65ZY1G
<b>FV-FP80ZY1G</b>	Replacement high efficiency filter for FV-80ZY1G and FV-1HZY1G <sup>1)</sup>
<b>FV-FP1KZY1G</b>	Replacement high efficiency filter for FV-1KZY1G and FV-2KZY1G <sup>1)</sup>
<b>PAW-ERV-IAQCT</b>	IAQ Controller

1) 2 sets of filters required for those models.

Recovers up to 83% of the heat in the outgoing air

ZY Series achieves more than 80% of heat exchange efficiency in all the line-up <sup>1)</sup>. The high recovery rate optimizes operation cost and can be considered as a sustainable solution.

1) Heating operation, H1 speed setting.

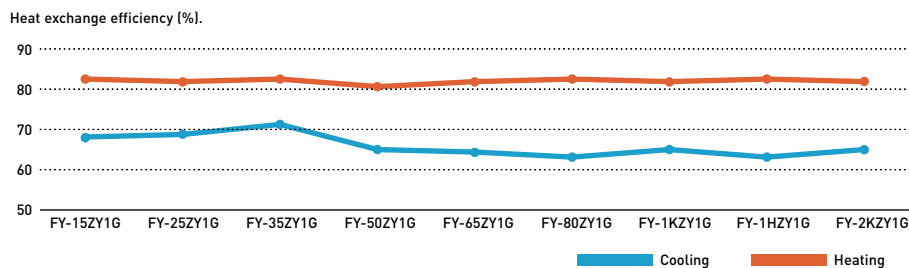

Ventilation volume setting PQ curve example.

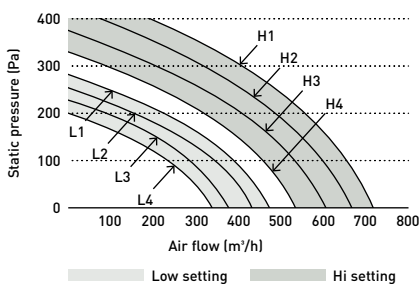

Easy adjust for air volume balance

DC motors are equipped with independent control settings for air supply and exhaust. Air volume balance can be easily adjusted with 4 speeds settings for each Hi / Low operation.

Intuitive remote controller with RS485 connection.

- Simple and clean screen with white back light panel
- RS485 terminal equipped to integrate with Building Management Systems
- Metal switch box is included in the package





**Energy recovery ventilation with DX coil - HRPT Series - R32 / R410A**

- Dual flow ventilation with EC fan, featuring high efficiency heat recovery (>85% η)
- 2 types of polystyrene heat exchanger (high efficiency and sensible) with counter-current flows and integrated bypass as standard
- Modbus connection available



+ COMPATIBLE WITH ALL PANASONIC CONNECTIVITY SOLUTIONS. FOR DETAILED INFORMATION GO TO THE CONTROL SYSTEMS SECTION

Indoor unit with high-efficiency heat exchanger		PAW-HRPT40HX	PAW-HRPT80HX	PAW-HRPT120HX	PAW-HRPT160HX	PAW-HRPT200HX					
Power supply	Voltage	V	230	230	230	380					
	Phase		Single phase	Single phase	Single phase	Three phase					
	Frequency	Hz	50	50	50	50					
<b>Heat recovery ventilation <sup>1)</sup></b>		<b>Cooling</b>	<b>Heating</b>	<b>Cooling</b>	<b>Heating</b>	<b>Cooling</b>	<b>Heating</b>	<b>Cooling</b>	<b>Heating</b>	<b>Cooling</b>	<b>Heating</b>
Temperature efficiency	%	63,4	76,7	60,0	73,5	61,4	75,0	62,2	76,0	59,4	73,2
Enthalpy efficiency	%	52,3	53,2	47,8	49,2	49,5	50,7	50,0	51,2	46,8	48,3
Weight	kg	70		120		135		150		180	

Indoor unit with sensible heat exchanger		PAW-HRPT40	PAW-HRPT80	PAW-HRPT120	PAW-HRPT160	PAW-HRPT200					
Power supply	Voltage	V	230	230	230	380					
	Phase		Single phase	Single phase	Single phase	Three phase					
	Frequency	Hz	50	50	50	50					
<b>Heat recovery ventilation <sup>1)</sup></b>		<b>Cooling</b>	<b>Heating</b>	<b>Cooling</b>	<b>Heating</b>	<b>Cooling</b>	<b>Heating</b>	<b>Cooling</b>	<b>Heating</b>	<b>Cooling</b>	<b>Heating</b>
Temperature efficiency	%	84,6	84,9	84,3	84,7	84,8	85,2	84,7	85,1	83,8	84,2
Weight	kg	67		117		132		147		177	

Common data		DX coil <sup>2)</sup>		Cooling	Heating	Cooling	Heating	Cooling	Heating	Cooling	Heating	Cooling	Heating
Total / Sensible capacity	kW	3,0 / 2,4	3,2	6,0 / 4,1	6,2	8,0 / 5,5	8,3	10,0 / 7,1	11,0	12,5 / 8,6	12,8		
Maximum input current	A	1,5		2,2		4,1		4,4		3,3			
Sound pressure @1 m / @3 m	dB(A)	41 / 35		51 / 43		42 / 36		49 / 41		57 / 49			
Air flow	High	480		800		1100		1500		1750			
External static pressure	High	150		150		150		150		150			
Dimension	H x W x D	mm		283 x 975 x 1400		408 x 1180 x 1720		408 x 1580 x 1720		408 x 1980 x 1720		408 x 1980 x 1720	
Piping diameter	Liquid	Inch (mm)		1/4 (6,35)		3/8 (9,52)		3/8 (9,52)		3/8 (9,52)		3/8 (9,52)	
	Gas	Inch (mm)		1/2 (12,70)		5/8 (15,88)		5/8 (15,88)		5/8 (15,88)		5/8 (15,88)	

1) Data refers to the following conditions (UNI EN 13141-7): nominal air flow, external air 5 °C with 72% r. / expelled air 25 °C with 28% r. 2) Data refers to the following conditions: nominal air flow, cooling inlet coil summer 27 °C with 48% / heating inlet coil winter 20 °C with 50% r. \* Image is for PAW-HRPT40.

Accessories	
<b>CZ-RTC6W</b>	CONEX wired remote controller (non-wireless), white
<b>CZ-RTC6WBL</b>	CONEX wired remote controller with Bluetooth®, white
<b>CZ-RTC6</b>	CONEX wired remote controller (non-wireless), black
<b>CZ-RTC6BL</b>	CONEX wired remote controller with Bluetooth®, black
<b>CZ-RTC5B</b>	Wired remote controller with Econavi function

Accessories	
<b>CZ-RWS3 + CZ-RWRC3</b>	Infrared remote controller and receiver
<b>PAW-RE2C4-MOD-WH</b>	Room controller for hotel rooms, white
<b>PAW-RE2C4-MOD-BK</b>	Room controller for hotel rooms, black
<b>PAW-RE2D4-WH</b>	Display control for hotel rooms, white
<b>PAW-RE2D4-BK</b>	Display control for hotel rooms, black

**Technical focus**

- Dual flow ventilation with EC fan, featuring high efficiency heat recovery (>85% η)
- 5 model line-up is available with air flow rates of 480, 800, 1100, 1500 and 1750 m³/h
- 2 types of polystyrene heat exchanger (high efficiency and sensible) with counter-current flows and integrated bypass as standard
- Automatic defrosting of the exchanger
- Low consumption and EC motors with electronic speed control ensure high useful static pressure for circular inlet connection to air ducts
- Wide ambient temperature range up to +50 °C and down to -15 °C
- Modbus connection available

**Interconnection to outdoor / indoor units**

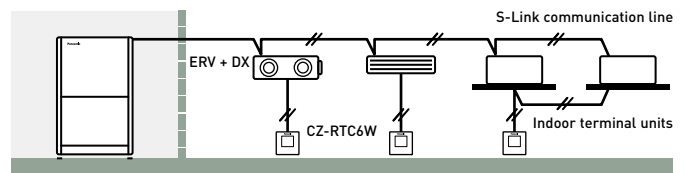

**Aeraulic performance**

EC motors with electronic speed control ensure high values of effective static pressure for ducting.

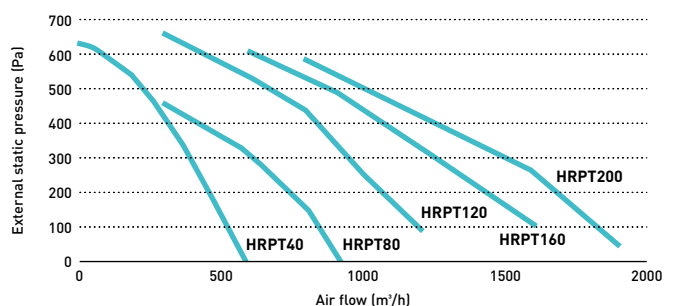

## Air curtain with DX coil, connected to VRF systems

**Comfort:** Easy redirection of air flow by means of manual deflector.

**Ease of use:** Speed selector (high and low) on the unit itself.

**Easy installation and maintenance:** Easy installation / Compact dimensions improve installation and positioning / Easy cleaning of grid without opening of the unit.



Outdoor unit capacity			4 HP	4 HP	5 HP	8 HP
Air outlet height 2,7 m			PAW-10EAIRC-LS	PAW-15EAIRC-LS	PAW-20EAIRC-LS	PAW-25EAIRC-LS
Cooling capacity <sup>1)</sup>	Max	kW	6,1	9,7	13,0	17,0
Heating capacity <sup>2)</sup>	Max	kW	7,9	12,0	15,0	19,0
Air flow	High	m <sup>3</sup> /h	1800	2700	3600	4500
Heat Exchanger	Volume	L	1,67	2,85	3,94	5,03
Electric consumption fan	230 V / 50 Hz	kW	0,30	0,50	0,60	0,80
Current	230 V / 50 Hz	A	2,10	3,10	4,10	5,10
Sound pressure <sup>3)</sup>	Max	dB(A)	65	66	67	69
Air outlet height 3,0 m			PAW-10EAIRC-HS	PAW-15EAIRC-HS	PAW-20EAIRC-HS	PAW-25EAIRC-HS
Cooling capacity <sup>1)</sup>	Max	kW	9,1	13,0	19,5	23,7
Heating capacity <sup>2)</sup>	Max	kW	11,8	15,8	23,6	27,6
Air flow	High	m <sup>3</sup> /h	2700	3600	5400	6300
Heat Exchanger	Volume	L	1,67	2,85	3,94	5,12
Electric consumption fan	230 V / 50 Hz	kW	0,75	1,00	1,50	1,75
Current	230 V / 50 Hz	A	4,10	5,50	8,20	9,60
Sound pressure <sup>3)</sup>	Max	dB(A)	66	67	68	68
Common data						
Dimension <sup>4)</sup>	HxWxD	mm	260 (+140) x 1000 x 460	260 (+140) x 1500 x 460	260 (+140) x 2000 x 460	260 (+140) x 2500 x 460
Net weight	Air outlet height 2,7 m	kg	50	65	80	95
	Air outlet height 3,0 m	kg	55	65	85	110
Fan type			EC	EC	EC	EC
Piping diameter	Liquid / Gas	Inch (mm)	3/8 (9,52) / 5/8 (15,88)	3/8 (9,52) / 3/4 (19,05)	3/8 (9,52) / 7/8 (22,22)	3/8 (9,52) / 7/8 (22,22)
Door width		m	1,0	1,5	2,0	2,5
Refrigerant			R32 / R410A	R32 / R410A	R32 / R410A	R32 / R410A

### LS / VRF outdoor combination

Operation until	40 °C	35 °C	30 °C
PAW-1EAIRC-LS	U-4	U-4	U-4
PAW-15EAIRC-LS	U-6	U-5	U-4
PAW-20EAIRC-LS	U-8	U-6	U-4
PAW-25EAIRC-LS	U-8	U-8	U-5

### HS / VRF outdoor combination

Operation until	40 °C	35 °C	30 °C
PAW-10EAIRC-HS	U-6	U-5	U-4
PAW-15EAIRC-HS	U-8	U-6	U-4
PAW-20EAIRC-HS	U-8	U-8	U-8
PAW-25EAIRC-HS	U-12	U-10	U-8

1) Cooling capacity DX coil, air temperature in / out +27 / +18 °C, R32 and R410. 2) Heating capacity condenser, air temperature in / out +20 / +33 °C, R32 and R410. In the case of lower outdoor temperatures, an outdoor model with higher capacity may be necessary. 3) Measured in distance up to 5,0 m, direction factor 2, absorbing surfaces 200 m<sup>2</sup>, Min / Max air flow. 4) 140 mm is the height of an electrical box if it is installed on the top. \* Also compatible with ECO G Series (GE3 and GF3) and Hybrid Serie.

## Technical focus

- Compatible with R32 and R410A refrigerant
- Save up to 40% energy costs by use of the integrated EC fan technology (higher efficiency than conventional AC fan, soft start and longer motor duration)
- 4 length of air curtain LS and HS are available 1,0, 1,5, 2,0 and 2,5 m
- Installation height up to 3,0 m
- Outlet grilles can be adjusted in five positions, to suite different indoor and installation requirements
- Control with Panasonic remote control systems (optional)
- Direct integration to BMS via optional Panasonic interfaces
- Drip tray included in all DX air curtains
- Drain pump included

## Internet control

An app added to your tablet or smartphone or via the Internet allows you to control and manage the system remotely. There is also the option to integrate into existing BMS systems by using other Panasonic interfaces.

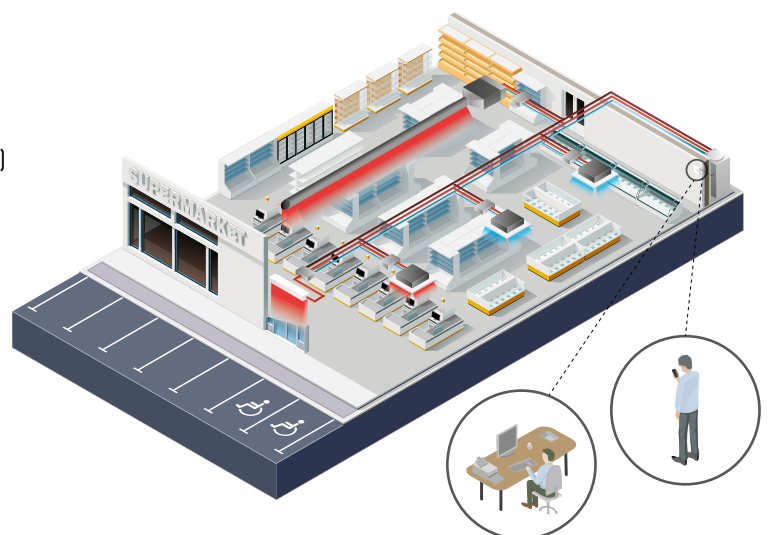

### Ceiling mounted air-e nanoe X Generator

- nanoe™ X technology  
(Generator Mark 1: 4,8 trillion hydroxyl radicals/sec)
- Silent operation. Whisper quiet at 25,5 dB(A)\*
- Low power consumption 4 W
- Easy installation
- Compact and modern design

\* 230 V.

air-e™



Model	FV-15CSD1G					
Power supply	Voltage	V	220	230	240	
	Frequency	Hz	50	50	50	
Air flow	m³/h		15	16	17	
	CFM		8,8	9,4	10,0	
Consumption	W		4	4	4	
Sound pressure	dB(A)		23,5	25,5	27,0	
Net weight	kg			1,1		

\* The value of air volume, power consumption and noise are specified at static pressure 0 Pa. The value of air volume is the mean value and a tolerance of +-10% is allowed. The value of noise level is a weighted average sound pressure level, the mean value is measured by Panasonic. A tolerance of +3 dB/-7 dB is allowed. The noise is measure at 1 m apart from the left, the front and below of the tested product. Conditions of generating nanoe™ X: room temperature: about 5 °C ~ 40 °C (dew point temperature more than 2 °C), relative humidity: about 30% ~ 85%. nanoe™ X is generated using the air in the room, and its amount is subject to the temperature and humidity in the air.

### One device is suitable for around 20 m² (with a ceiling height 3 m)

Ex. 3 air-e devices are required for the room size 60 m².

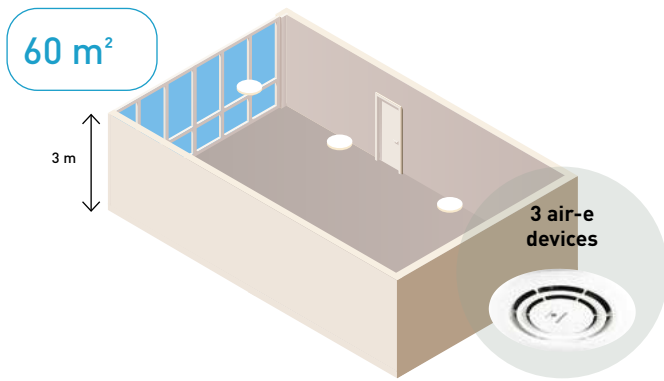

### Concentration simulator is ready

See how nanoe™ X fills space.

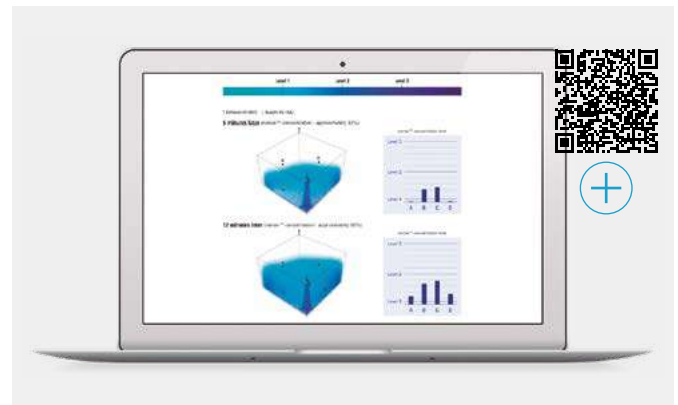

The air-e is a stand alone device which is an easy and simple choice to improve indoor air quality. It can be easily installed to various commercial projects including refurbishments.

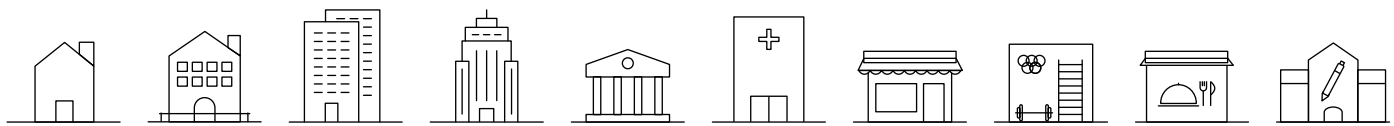

### The tested effects of nanoe™ X

#### Bacteria and viruses.

SARS-CoV-2: 99,9% % inhibited <sup>1)</sup>

Influenza virus H1N1 subtype: 99,9 % inhibited <sup>2)</sup>

#### Odour.

nanoe X Generator can reduce cigarette smoke odour intensity by 2,4 levels in 12 minutes.

- 1) Novel coronavirus [SARS-CoV-2] > [Test organization] Texcell [France] [Test subject] Adhered novel coronavirus [SARS-CoV-2] [Test volume] 45 L enclosed box [Test result] Inhibited 99,9% in 2 hours [Test report] 1140-01 A1.
- 2) Adhered virus [Influenza virus H1N1 subtype] > [Test organization] Kitasato Research Center for Environmental Science [Test subject] Influenza virus [H1N1 subtype] [Test volume] 1000 L enclosed box [Test result] Inhibited 99,9% in 2 hours [Test report] 21\_0084\_1.
- 3) Deodorisation effect for adhering odour [cigarette smoke] > [Test organization] Panasonic Product Analysis Center [Test subject] Adhered cigarette smoke odour [Test volume] Approx. 24 m³ laboratory [Test result] Odour intensity reduced 2,4 levels in 0,2 hours [Test report] 4AA33-160615-N04.

Performance of nanoe™ X might differ in real life environment and is only expected in the same room as where the unit is placed. The nanoe™ X performance varies depending on the room size, environment and usage and it may take several hours to reach the full effect. nanoe™ X is not a medical device.

Deodorisation effect for adhering odour (cigarette smoke) <sup>3)</sup>.

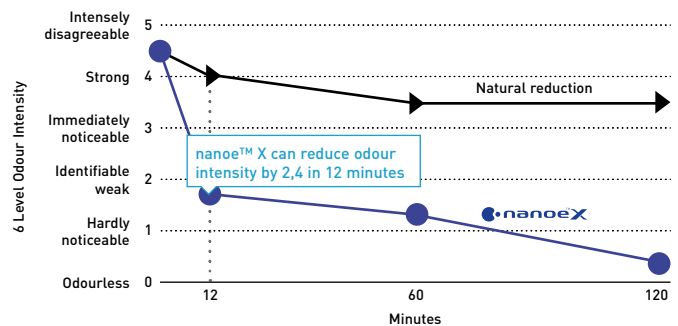

For further details and validation data, please refer to the following website.



# Accessories and control

## Distribution joint kits







<b>2-Pipe ME2 for outdoor units (up to 68,0 kW).</b> ----- CZ-P680PH2BM	<b>2-Pipe ME2 for outdoor units (from 68,0 kW to 168,0 kW).</b> ----- CZ-P1350PH2BM	<b>2-Pipe ME2 and Mini ECOi for indoor units (up to 22,4 kW*).</b> ----- CZ-P224BK2BM
<b>2-Pipe ME2 for indoor units (from 22,4 kW to 68,0 kW*).</b> ----- CZ-P680BK2BM	<b>2-Pipe ME2 for indoor units (from 68,0 kW to 168,0 kW*).</b> ----- CZ-P1350BK2BM	<b>3-Pipe MF3 for outdoor units (up to 68,0 kW).</b> ----- CZ-P680PJ2BM
<b>3-Pipe MF3 for outdoor units (from 68,0 kW to 135,0 kW).</b> ----- CZ-P1350PJ2BM	<b>3-Pipe MF3 for indoor units (up to 22,4 kW).</b> ----- CZ-P224BH2BM	<b>3-Pipe MF3 for indoor units (from 22,4 kW to 68,0 kW).</b> ----- CZ-P680BH2BM
<b>3-Pipe MF3 for indoor units (up to 68,0 kW).</b> ----- CZ-P1350BH2BM	<b>2-Pipe ME2 header pipe.</b> ----- CZ-P4HP4C2BM	<b>3-Pipe MF3 header pipe.</b> ----- CZ-P4HP3C2BM



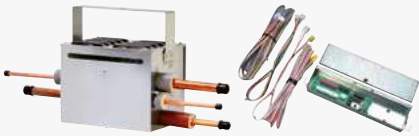

\* In case the total capacity of indoor units connected after distribution exceeds the total capacity of the outdoor units, select the distribution piping size for the total capacity of the outdoor units.

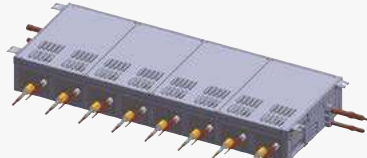
## Heat recovery box



 <p><b>3-Pipe control Solenoid valve kit (up to 5,6 kW).</b>          CZ-P56HR3 + CZ-CAPE2.          -----          KIT-P56HR3</p>	 <p><b>Solenoid valve kit (up to 5,6 kW).</b>          -----          CZ-P56HR3</p>	 <p><b>3-Pipe control PCB.</b>          -----          CZ-CAPE2</p>
<p><b>3-Pipe control Solenoid valve kit (from 5,6 to 16,0 kW).</b>          CZ-P160HR3 + CZ-CAPE2.          -----          KIT-P160HR3</p>	<p><b>Solenoid valve kit (from 5,6 kW to 16,0 kW).</b>          -----          CZ-P160HR3</p>	<p><b>3-Pipe control PCB for wall-mounted.</b>          -----          CZ-CAPEK2</p>
 <p><b>4 ports 3 pipe box (up to 5,6 kW per port).</b>          -----          CZ-P456HR3</p>	 <p><b>6 ports 3 pipe box (up to 5,6 kW per port).</b>          -----          CZ-P656HR3</p>	 <p><b>8 ports 3 pipe box (up to 5,6 kW per port).</b>          -----          CZ-P856HR3</p>
<p><b>4 ports 3 pipe box (up to 16,0 kW per port).</b>          -----          CZ-P4160HR3</p>		

## Panels

 <p><b>Standard panel for 4 way 90x90 cassette, white (RAL9003).</b>          -----          CZ-KPU3</p>	 <p><b>Econavi panel for 4 way 90x90 cassette, white (RAL9003).</b>          -----          CZ-KPU3A</p>	 <p><b>NEW Standard panel for 4 way 90x90 cassette, graphite black (RAL9011).</b>          -----          CZ-KPU3B</p>	 <p><b>Panel for 4 way 60x60 cassette - MY3.</b>          -----          CZ-KPY4</p>
---	---	--	---



Panel for ML1 22 to 56.

-----  
CZ-02KPL2



Panel for MD1.

-----  
CZ-KPD2

Panel for ML1 73.

-----  
CZ-03KPL2

Sensors



Econavi energy saving sensor.

-----  
CZ-CENSC1



Remote temperature sensor.

-----  
CZ-CSRC3

Fresh air-intake kit.

-----  
CZ-FDU3+CZ-ATU2

R32 safety measures



Leak detector for 4 way 90x90 cassette, 4 way 60x60 cassette, and wall-mounted units.

-----  
CZ-CGLSC2



R32 refrigerant leak alarm for adaptive duct and slim duct units.

-----  
CZ-CGLALC1



2-pipe safety valve kit.

-----  
CZ-P1160SVK



External 16 V power supply.

-----  
PAW-16DC-ALC1

IAQ filter for adaptive ducted unit



\* Tentative image.

BION air pollutant filter for MF3 15 to 56.

-----  
PAW-APF800F

BION air pollutant filter for MF3 60 and 73.

-----  
PAW-APF1000F

BION air pollutant filter for MF3 90 to 160.

-----  
PAW-APF1400F

Plenums

Valves

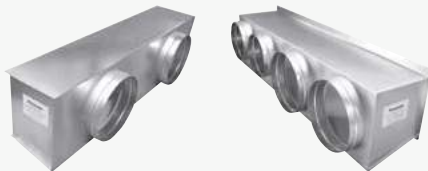

Air outlet plenum for MF3 15, 22, 28, 36, 45 and 56.

-----  
CZ-56DAF2

Air outlet plenum for MF3 60, 73 and 90.

-----  
CZ-90DAF2

Air outlet plenum for MF3 112, 140 and 160.

-----  
CZ-106DAF2



Air outlet plenum for S-224ME1E5.

-----  
CZ-TREMIESPW705

Air outlet plenum for S-280ME1E5.

-----  
CZ-TREMIESPW706



External valve for MK3 15 to 73.

-----  
CZ-P73SVK3\*

External valve for MK3 106.

-----  
CZ-P106SVK3

Rap valve kit.

-----  
CZ-P160RVK2

\* A 3/8" to 1/4" reducer is required when combining the S-73MK3E with ECOI EX R410A outdoor units (ME2 and MF3).

VRF Smart Connectivity+



Remote controller Panasonic Net Con, RH, No PIR, R1/R2.

-----  
SER8150R0B1194

Remote controller Panasonic Net Con, RH, PIR, R1/R2.

-----  
SER8150R5B1194



Wireless ZigBee® Pro module / Green Com card.

-----  
VCM8000V5094P



Door/window wireless sensor.

-----  
SED-WDC-G-5045



Wall/ceiling motion/temperature/humidity sensor.

-----  
SED-MTH-G-5045



CO<sub>2</sub> sensor.

-----  
SED-CO2-G-5045



Sensor with room temperature and humidity.

-----  
SED-TRH-G-5045



Water leakage sensor.

-----  
SED-WLS-G-5045



Cover frame. Silver.

-----  
FAS-00



Cover frame. White.

-----  
FAS-01



Cover frame. Glossy translucent white.

-----  
FAS-03



Cover frame. Light tan wood.

-----  
FAS-05



Cover frame. Dark brown wood.

-----  
FAS-06



Cover frame. Dark black wood.

-----  
FAS-07



Cover frame. Brushed steel finish.

-----  
FAS-10

Controller and touch controllers for hotels with dry contacts



**Modbus RS-485 touch room controller with I/O, white.**

PAW-RE2C4-MOD-WH

**Touch display control with 2 digital inputs, white.**

PAW-RE2D4-WH



**Modbus RS-485 touch room controller with I/O, black.**

PAW-RE2C4-MOD-BK

**Touch display control with 2 digital inputs, black.**

PAW-RE2D4-BK

Hotel sensors for dry contacts



**Wall silent motion sensor 24 V.**

PAW-WMS-DC

**Wall silent motion sensor 240 V AC.**

PAW-WMS-AC



**Ceiling silent motion sensor 24 V.**

PAW-CMS-DC

**Ceiling silent motion sensor 240 V AC.**

PAW-CMS-AC



**Power supply 24 V.**

PAW-24DC



**Door or window contact.**

PAW-DWC

Centralised controls



**System controller for 64 indoor units with weekly timer.**

CZ-64ESMC3

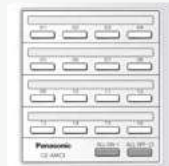

**Central ON / OFF controller, up to 16 groups, 64 indoor units.**

CZ-ANC3



**Intelligent controller (touch screen/web server) to control up to 256 indoors with included load distribution ratio (LDR).**

CZ-256ESMC3

Centralised controls. BMS system. PC base



**P-AIMS core software: Centralised software to control up to 1024 indoor units.**

CZ-CSWKC2

**P-AIMS communication adaptor.**

CZ-CFUNC2

**P-AIMS consumption calculation extension.**

CZ-CSWAC2

**P-AIMS layout display extension.**

CZ-CSWGC2

**P-AIMS BACnet extension.**

CZ-CSWBC2

**P-AIMS web application extension.**

CZ-CSWWC2

Panasonic AC Smart Cloud



+ ALL REFERENCES RELATED TO AC SMART CLOUD IS IN THE DEDICATED PAGE

**Panasonic AC Smart Cloud. Cloud internet control. Up to 128 groups. Controls 128 units.**

-----  
CZ-CFUSCC1

BMS interface with S-Link



**A unified interface supporting Modbus, BACnet, and KNX protocols for up to 16 indoor units.**

-----  
PAW-AC2-BMS-16

**A unified interface supporting Modbus, BACnet, and KNX protocols for up to 64 indoor units.**

-----  
PAW-AC2-BMS-64

**A unified interface supporting Modbus, BACnet, and KNX protocols for up to 128 indoor units.**

-----  
PAW-AC2-BMS-128

Accessories interfaces



**Commercial Wi-Fi Adaptor.**

-----  
CZ-CAPWFC2



**KNX interface (Intesis).**

-----  
PAW-RC2-KNX-1i



**Modbus RTU interface (Intesis).**

-----  
PAW-RC2-MBS-1



**Modbus RTU interface to control 4 indoor/groups (Intesis).**

-----  
PAW-RC2-MBS-4



**BACnet IP and MSTP (Intesis).**

-----  
PAW-RC2-BAC-1



**KNX interface (Airzone).**

-----  
PAW-AZRC-KNX-1



**Modbus RTU interface (Airzone).**

-----  
PAW-AZRC-MBS-1



**BACnet IP and MSTP interface (Airzone).**

-----  
PAW-AZRC-BAC-1



**RAC interface adapter for integration into S-Link, plus external input and alarm/status output.**

-----  
CZ-CAPRA1



**LonWorks® Interface controls up to 16 groups and 64 indoor units.**















-----  
CZ-CLNC2



Centralised controls. Connection with general equipment

 <p><b>Adaptor for ON / OFF control of external devices.</b></p> <p>-----</p> <p>CZ-CAPC3</p>	 <p><b>Demand control for Mini ECOi (LZ2, LE2).</b></p> <p>-----</p> <p>CZ-CAPDC3</p>	 <p><b>Mini series parallel device controlling indoor units, maximum 1 group and 8 indoor unit.</b></p> <p>-----</p> <p>CZ-CAPBC2</p>	 <p><b>Communication Adaptor. Up to 128 groups. Controls 128 units.</b></p> <p>-----</p> <p>CZ-CFUNC2</p>
--	--	---	--

Individual controls

 <p><b>CONEX wired remote controller (non-wireless), white.</b></p> <p>-----</p> <p>CZ-RTC6W</p>	 <p><b>CONEX wired remote controller with Bluetooth®, white.</b></p> <p>-----</p> <p>CZ-RTC6WBL</p>	 <p><b>CONEX wired remote controller with Wi-Fi and Bluetooth®, white.</b></p> <p>-----</p> <p>CZ-RTC6WBLW2*</p>	 <p><b>CONEX wired remote controller (non-wireless), black.</b></p> <p>-----</p> <p>CZ-RTC6</p>
 <p><b>CONEX wired remote controller with Bluetooth®, black.</b></p> <p>-----</p> <p>CZ-RTC6BL</p>	 <p><b>CONEX wired remote controller with Wi-Fi and Bluetooth®, black.</b></p> <p>-----</p> <p>CZ-RTC6BLW2*</p>	 <p><b>Design wired remote controller with Econavi function.</b></p> <p>-----</p> <p>CZ-RTC5B</p>	 <p><b>Infrared remote controller and receiver for 4 way 60x60 cassette - MY3 with panel.</b></p> <p>-----</p> <p>CZ-RWS3 + CZ-RWR3</p>
 <p><b>Infrared remote controller and receiver for 4 way 90x90 cassette.</b></p> <p>-----</p> <p>CZ-RWS3 + CZ-RWRU3</p>	 <p><b>Infrared remote controller and receiver for 2 way cassette.</b></p> <p>-----</p> <p>CZ-RWS3 + CZ-RWRL3</p>	 <p><b>Infrared remote controller and receiver for 1 way cassette.</b></p> <p>-----</p> <p>CZ-RWS3 + CZ-RWRD3</p>	
 <p><b>Infrared remote controller and receiver for ceiling.</b></p> <p>-----</p> <p>CZ-RWS3 + CZ-RWRT3</p>	 <p><b>Infrared remote controller for wall-mounted and floor console.</b></p> <p>-----</p> <p>CZ-RWS3</p>	 <p><b>Infrared remote controller and receiver for all indoor units.</b></p> <p>-----</p> <p>CZ-RWS3 + CZ-RWRC3</p>	

\* Available for indoor unit types MY3, MF3, MM2, and MK3.

Accessories PCB



**T10 interface PCB with digital and relay connections.**

-----  
PAW-T10

**PCB for fan speed control of external EC Fan.**

-----  
PAW-ECF

R-22 Replacement Kit

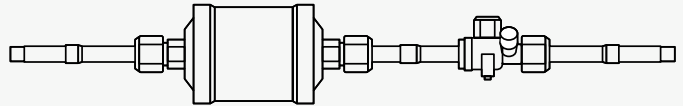

**Replacement kit for R-22.**

-----  
CZ-SLK2

Accessories cables

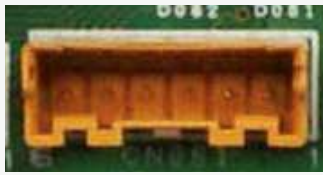

**Cable for all the T10 functions.**

-----  
CZ-T10



**Cable to operate external EC fan.**

-----  
PAW-FDC



**Cable for all option monitoring signals.**

-----  
PAW-OCT



**Cable with force thermo OFF/leakage detection.**

-----  
PAW-EXCT

Water heat exchanger accessories

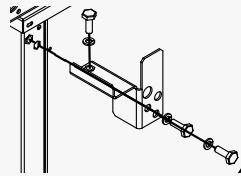

**Stacking kit for vertically stacking up to 3 WHE (4 pieces per Kit).**

-----  
PAW-3WSK



## Advanced energy recovery ventilation - ZY Series accessories

**Replacement high efficiency filter for FV-15ZY1G.**

FV-FP15ZY1G

**Replacement high efficiency filter for FV-35ZY1G.**

FV-FP35ZY1G

**Replacement high efficiency filter for FV-65ZY1G.**

FV-FP65ZY1G

**Replacement high efficiency filter for FV-1KZY1G and FV-2KZY1G <sup>1)</sup>.**

FV-FP1KZY1G

**Replacement high efficiency filter for FV-25ZY1G.**

FV-FP25ZY1G

**Replacement high efficiency filter for FV-50ZY1G.**

FV-FP50ZY1G

**Replacement high efficiency filter for FV-80ZY1G and FV-1HZY1G <sup>1)</sup>.**

FV-FP80ZY1G

**IAQ Controller.**

PAW-ERV-IAQCT

1) 2 sets of filters required for those models.

# Dimensions and tube sizes of branches and headers for 2-Pipe ECOi EX ME2 and Mini ECOi Series

## Optional distribution joint kits

See the installation instructions packaged with the distribution joint kit for the installation procedure.

\* In case the total capacity of indoor units connected after distribution exceeds the total capacity of the outdoor units, select the distribution piping size for the total capacity of the outdoor units.

Model name	Cooling capacity after distribution	Remarks
1. CZ-P680PH2BM	Up to 68,0 kW	For outdoor unit
2. CZ-P1350PH2BM	From 68,0 kW to 168,0 kW	For outdoor unit
3. CZ-P224BK2BM*	Up to 22,4 kW	For indoor unit
4. CZ-P680BK2BM*	From 22,4 kW to 68,0 kW	For indoor unit
5. CZ-P1350BK2BM*	From 68,0 kW to 168,0 kW	For indoor unit

## Tubing size (with thermal insulation)

1. CZ-P680PH2BM: For outdoor unit side (capacity after distribution joint up to 68,0 kW).

Gas piping

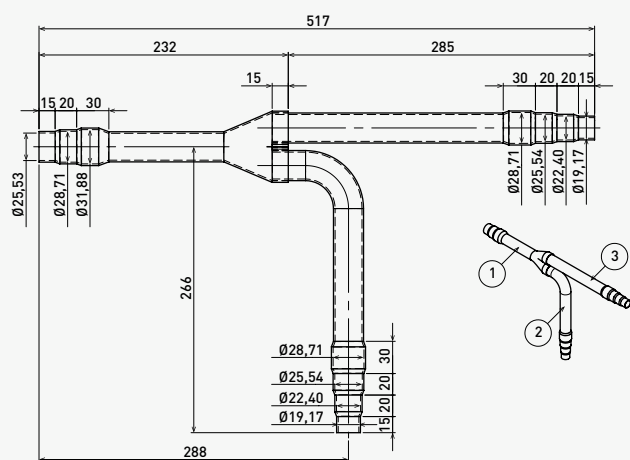

Liquid piping

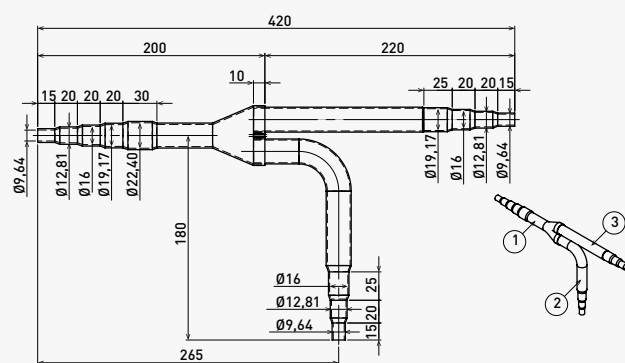

Unit: mm

2. CZ-P1350PH2BM: For outdoor unit side (capacity after distribution joint is from 68,0 kW to 168,0 kW).

Gas piping

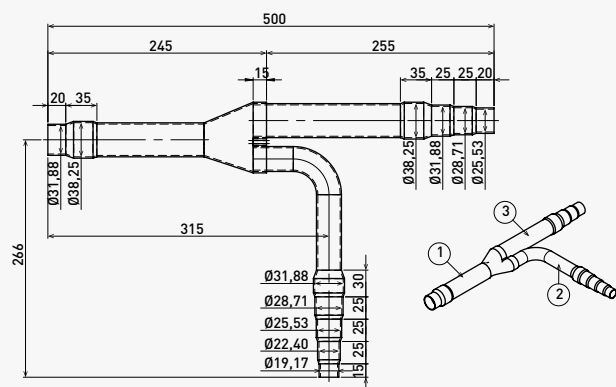

Liquid piping

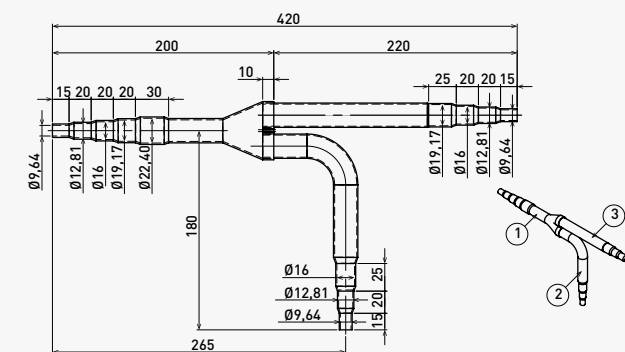

Unit: mm

3. CZ-P224BK2BM: For indoor unit side (capacity after distribution joint up to 22,4 kW).

Gas piping

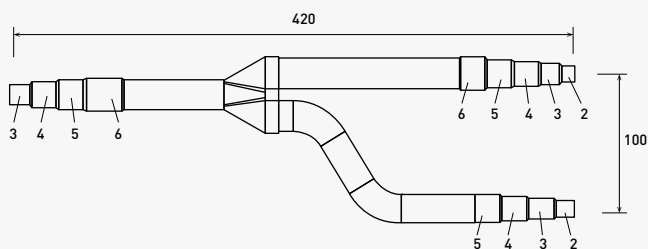

Liquid piping

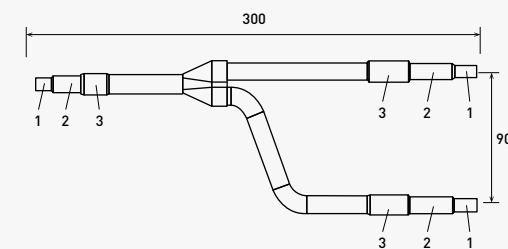

Unit: mm

**4. CZ-P680BK2BM:** For indoor unit side (capacity after distribution joint is from 22,4 kW to 68,0 kW).

Gas piping

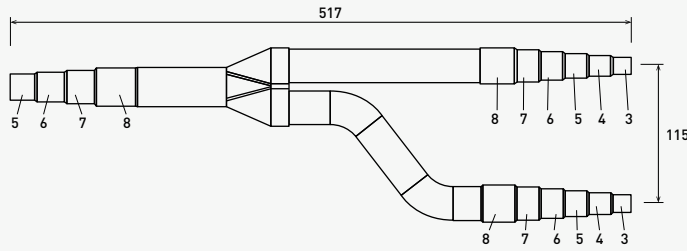

Liquid piping

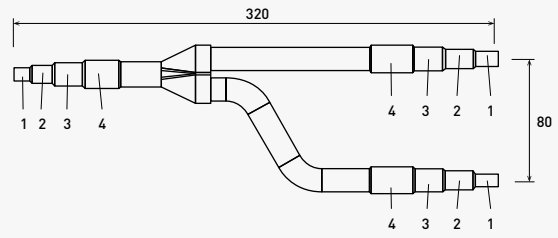

Unit: mm

**5. CZ-P1350BK2BM:** For indoor unit side (capacity after distribution joint is from 68,0 kW to 168,0 kW).

Gas piping

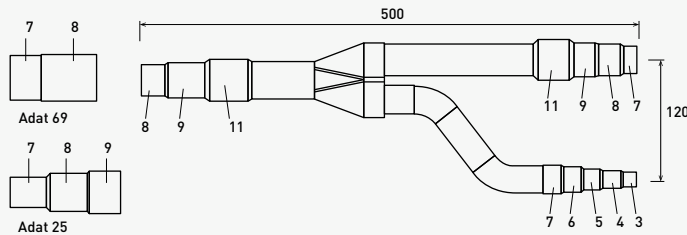

Liquid piping

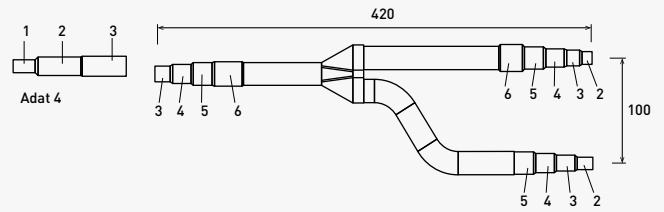

Unit: mm

Size of connection point on each part (shown are inside diameters of piping)

Diameters		1	2	3	4	5	6	7	8	9	10	11	12	13	14
Dimension	Inch	1/4	3/8	1/2	5/8	3/4	7/8	1	1 1/8	1 1/4	1 3/8	1 1/2	1 5/8	1 3/4	2
	mm	6,35	9,52	12,70	15,88	19,05	22,40	25,40	28,57	31,75	34,92	38,10	41,28	44,45	50,80

**Header pipe set**

**CZ-P4HP4C2BM**

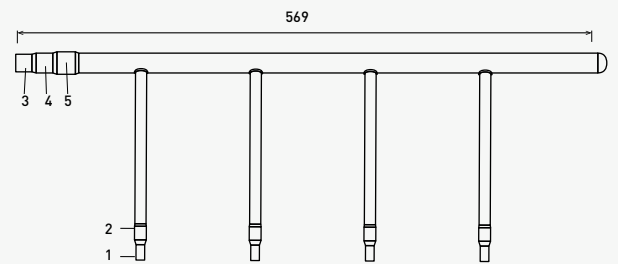
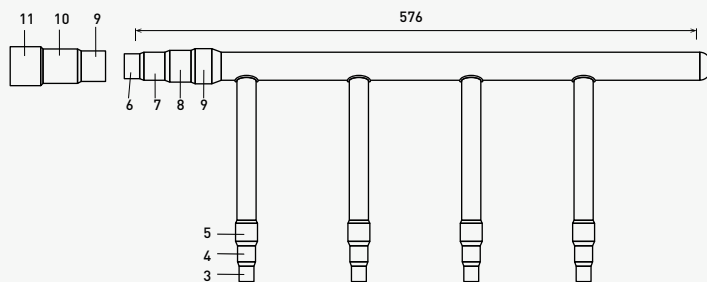

Size of connection point on each part (shown are inside diameters of piping)

Diameters		1	2	3	4	5	6	7	8	9	10	11
Dimension	Inch	1/4	3/8	1/2	5/8	3/4	7/8	1	1 1/8	1 1/4	1 3/8	1 1/2
	mm	6,35	9,52	12,70	15,88	19,05	22,40	25,40	28,57	31,75	34,92	38,10

**Distribution joint Kits for Mini ECOi LE/LZ Series**

**CZ-P224BK2BM:** For indoor unit side (capacity after distribution joint up to 22,4 kW).

Gas piping

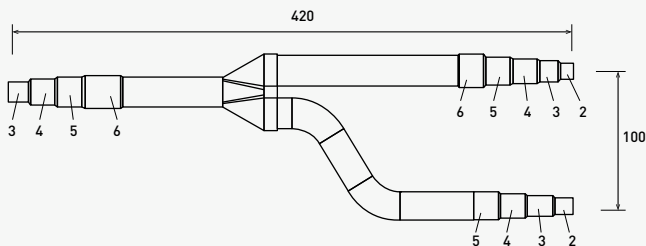

Liquid piping

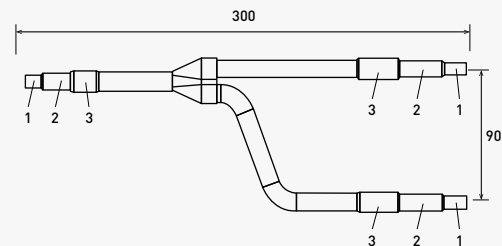

Unit: mm

Size of connection point on each part (shown are inside diameters of piping)

Diameters		1	2	3	4	5	6
Dimension	Inch	1/4	3/8	1/2	5/8	3/4	7/8
	mm	6,35	9,52	12,70	15,88	19,05	22,40

# Dimensions and tube sizes of branches and headers for 3-Pipe ECOi EX MF3 Series

## Optional distribution joint kits

See the installation instructions packaged with the distribution joint kit for the installation procedure.

Model name	Cooling capacity after distribution	Remarks
1. CZ-P680PJ2BM	Up to 68,0 kW	For outdoor unit
2. CZ-P1350PJ2BM	From 68,0 kW to 135,0 kW	For outdoor unit
3. CZ-P224BH2BM	Up to 22,4 kW	For indoor unit
4. CZ-P680BH2BM	From 22,4 kW to 68,0 kW	For indoor unit
5. CZ-P1350BH2BM	From 68,0 kW to 135,0 kW	For indoor unit

## Piping size

1. CZ-P680PJ2BM: For outdoor unit side (capacity after distribution joint up to 68,0 kW).

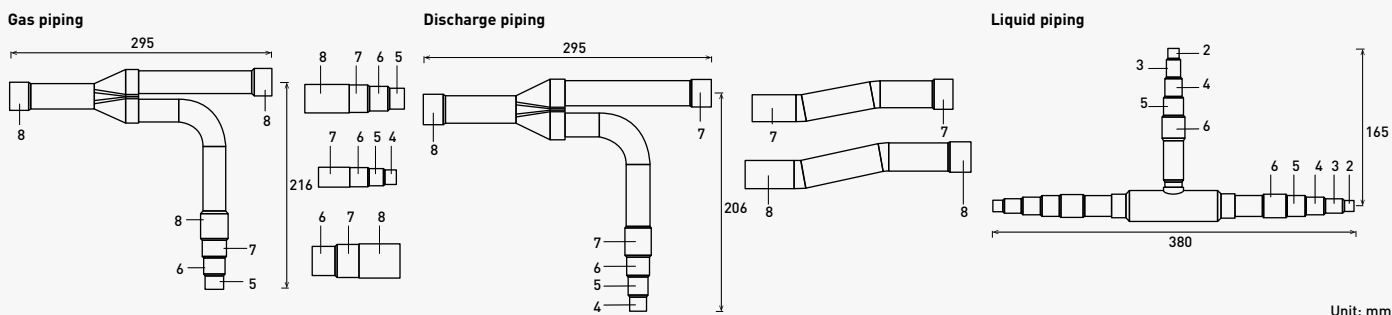

2. CZ-P1350PJ2BM: For outdoor unit side (capacity after distribution joint is from 68,0 kW to 135,0 kW).

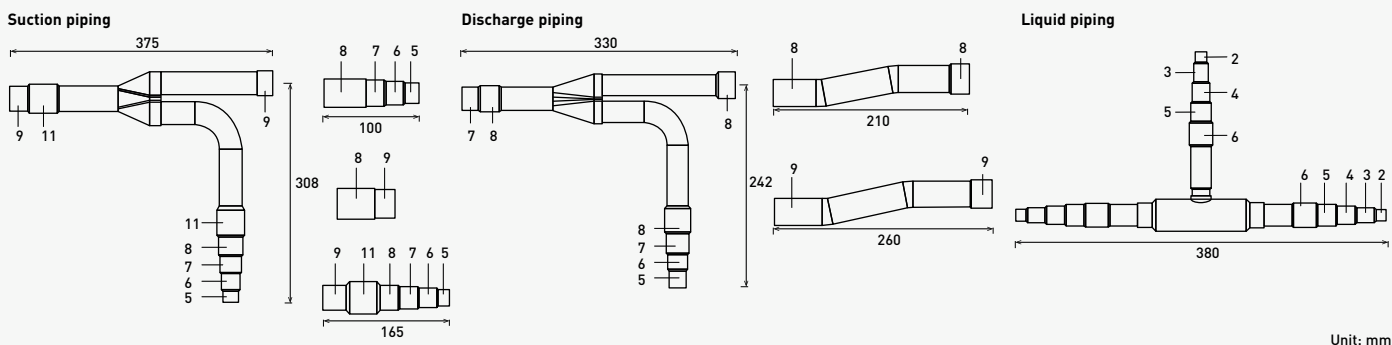

3. CZ-P224BH2BM: For indoor unit side (capacity after distribution joint up to 22,4 kW).

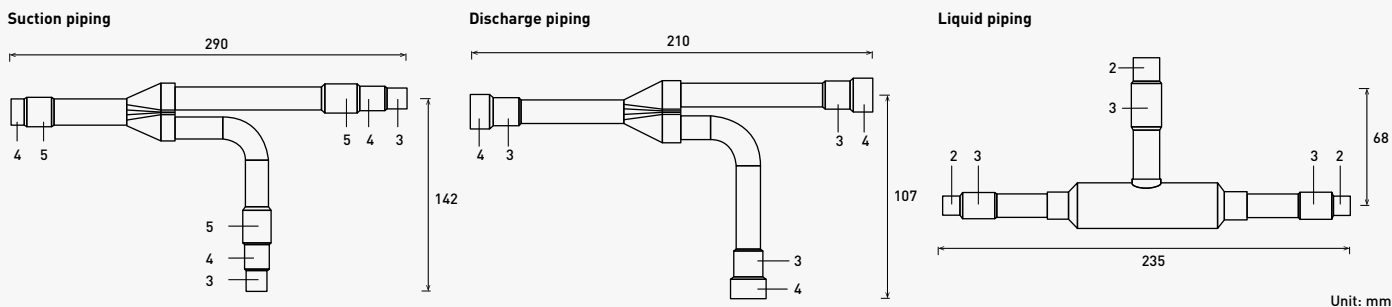

**4. CZ-P680BH2BM:** For indoor unit side (capacity after distribution joint is from 22,4 kW to 68,0 kW).

Suction piping

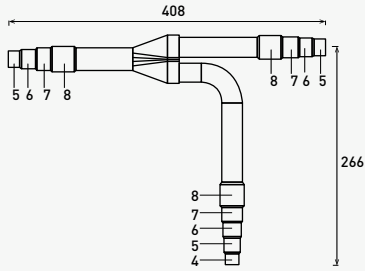

Discharge piping

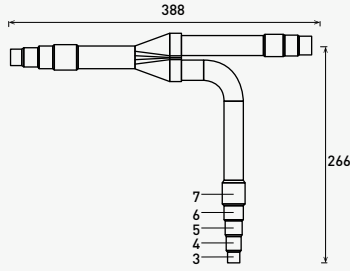

Liquid piping

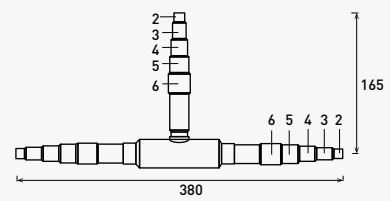

Unit: mm

**5. CZ-P1350BH2BM:** For indoor unit side (capacity after distribution joint is from 68,0 kW to 135,0 kW).

Suction piping

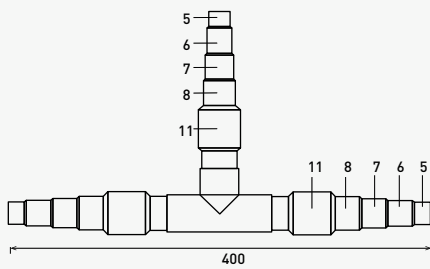

Discharge piping

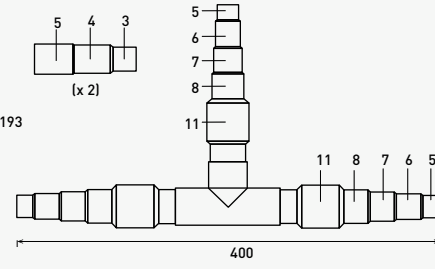

Liquid piping

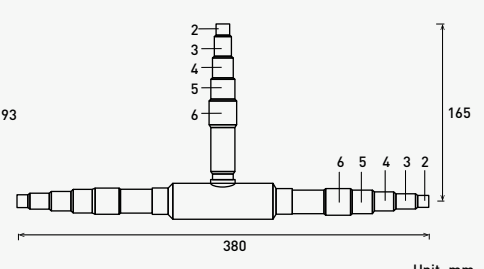

Unit: mm

Size of connection point on each part (shown are inside diameters of piping)

Diameters	1	2	3	4	5	6	7	8	9	10	11	12	13	14
Inch	1/4	3/8	1/2	5/8	3/4	7/8	1	1 1/8	1 1/4	1 3/8	1 1/2	1 5/8	1 3/4	2
Dimension	mm	6,35	9,52	12,70	15,88	19,05	22,40	25,40	31,75	34,92	38,10	41,28	44,45	50,80

Header pipe set

**CZ-P4HP3C2BM**

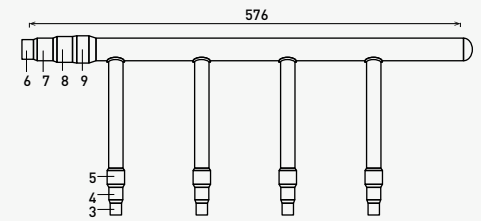
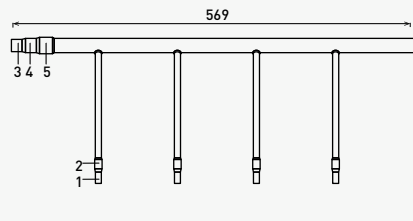
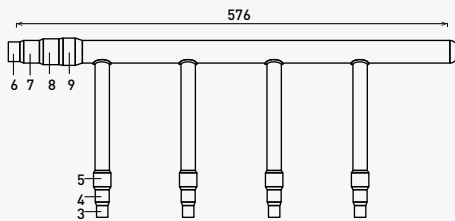

Size of connection point on each part (shown are inside diameters of piping)

Diameters	1	2	3	4	5	6	7	8	9	10	11	
Inch	1/4	3/8	1/2	5/8	3/4	7/8	1	1 1/8	1 1/4	1 3/8	1 1/2	
Dimension	mm	6,35	9,52	12,70	15,88	19,05	22,40	25,40	28,57	31,75	34,92	38,10

## Eurovent certified technical data

Panasonic's PACi and VRF systems are now certified by Eurovent\*.

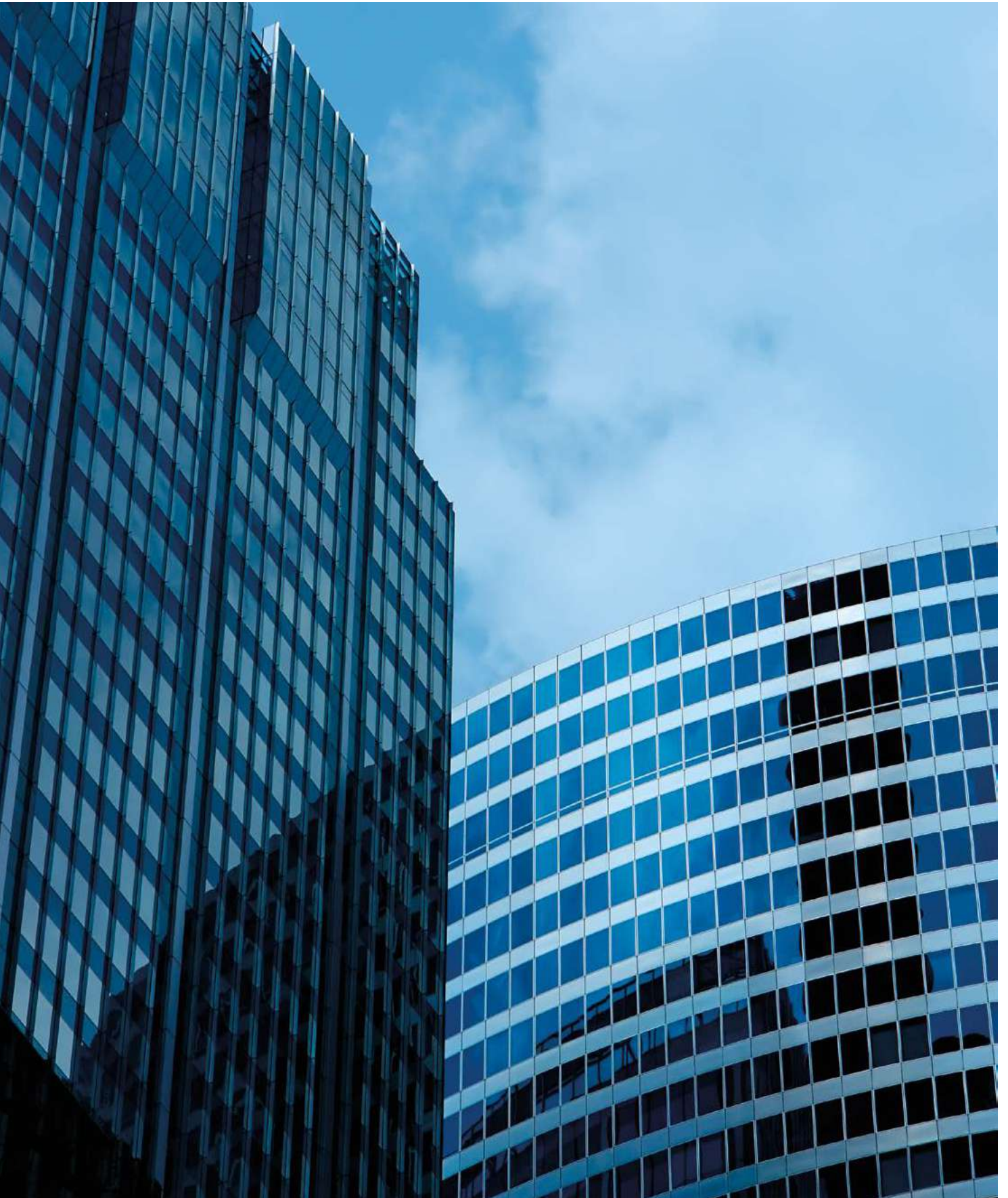



The Eurovent certification verifies the performance ratings of heating and cooling systems following European standards. Data provides products efficiency with full transparency, for the benefit of customers and professionals.



**Eurovent VRF certified technical data: Mini ECOi LZ2 Series 4 to 10 HP · R32**

HP	4 HP				5 HP				6 HP				8 HP		10 HP		
	U-4LZ2E5		U-4LZ2E8		U-5LZ2E5		U-5LZ2E8		U-6LZ2E5		U-6LZ2E8		U-8LZ2E8		U-10LZ2E8		
Outdoor unit	2x		3x		2x		3x		2x		2x		4x		4x		
Indoor units combination	S-60MU2		S-28MF3		S-60MU2		S-28MF3		S-36MU2		S-36MF3		S-36MU2		S-56MU2		
S-**-MU2: S-**-MU2E5C	S-60MU2		S-28MF3		S-60MU2		S-28MF3		S-36MU2		S-36MF3		S-36MU2		S-56MU2		
S-**-MF3: S-**-MF3E5D	S-36MF3		S-36MF3		S-36MF3		S-36MF3		S-45MU2		S-45MF3		S-45MU2		S-45MF3		
Cooling	Pc out <sup>1)</sup> kW	12,1	12,1	12,1	12,1	14,0	14,0	14,0	14,0	15,5	15,5	15,5	15,5	22,4	19,0	28,0	23,8
	Pec out <sup>2)</sup> kW	3,0	3,6	3,0	3,6	3,7	4,5	3,7	4,5	4,4	5,2	4,4	5,2	6,8	6,8	9,7	9,5
	EERout	4,1	3,4	4,1	3,4	3,8	3,1	3,8	3,1	3,5	3,0	3,5	3,0	3,3	2,8	2,9	2,5
Seasonal Cooling	SEER	8,5	6,8	8,5	6,8	8,1	6,8	8,1	6,8	7,7	6,5	7,7	6,5	7,6	5,8	7,1	5,7
	η <sub>sc</sub> %	337,0	270,6	337,0	270,6	321,8	267,4	321,8	267,4	305,4	258,2	305,4	258,2	299,4	228,6	280,2	225,8
Cooling PL Condition B	PcB kW	8,9	8,9	8,9	8,9	10,3	10,3	10,3	10,3	11,4	11,4	11,4	11,4	16,5	14,0	20,6	17,5
	EERB	6,5	5,2	6,5	5,2	5,9	4,9	5,9	4,9	5,4	4,7	5,4	4,7	5,2	4,2	4,6	4,0
Cooling PL Condition C	PcC kW	5,7	5,7	5,7	5,7	6,6	6,6	6,6	6,6	7,3	7,3	7,3	7,3	10,6	9,0	13,2	11,2
	EERC	11,3	8,8	11,3	8,8	10,8	9,0	10,8	9,0	10,2	8,8	10,2	8,8	9,6	7,0	8,7	6,7
Cooling PL Condition D	PcD kW	5,4	5,4	5,4	5,4	5,6	5,4	5,6	5,4	5,8	5,4	5,8	5,4	9,0	7,1	9,5	8,0
	EERD	15,6	12,3	15,6	12,3	15,2	12,1	15,2	12,1	15,0	11,0	15,0	11,0	16,6	11,5	18,0	13,1
Seasonal Heating	Pdesignh kW	10,0	10,0	10,0	10,0	11,2	11,2	11,2	11,2	11,6	11,6	11,6	11,6	17,5	16,2	19,6	18,2
	SCOP	5,1	4,0	5,1	4,0	4,6	3,9	4,6	3,9	4,6	3,7	4,6	3,7	4,6	3,8	4,6	3,9
	η <sub>sh</sub> %	199,0	155,8	199,0	155,8	181,4	151,0	181,4	151,0	180,6	146,6	180,6	146,6	180,6	147,4	181,0	151,4
Heating PL Condition A	PhA kW	8,8	8,8	8,8	8,8	9,9	9,9	9,9	9,9	10,3	10,3	10,3	10,3	15,4	14,3	17,3	16,1
	COPA	3,1	2,5	3,1	2,5	2,9	2,4	2,9	2,4	2,9	2,3	2,9	2,3	2,9	2,4	2,8	2,3
Heating PL Condition B	PhB kW	5,4	5,4	5,4	5,4	6,0	6,0	6,0	6,0	6,2	6,2	6,2	6,2	9,4	8,7	10,5	9,8
	COPB	4,8	3,6	4,8	3,6	4,1	3,4	4,1	3,4	4,1	3,3	4,1	3,3	4,2	3,5	4,2	3,6
Heating PL Condition C	PhC kW	3,5	3,5	3,5	3,5	3,9	3,9	3,9	3,9	4,0	4,0	4,0	4,0	6,2	5,6	6,7	6,3
	COPC	7,2	6,1	7,2	6,1	7,2	6,2	7,2	6,2	7,1	6,1	7,1	6,1	6,9	5,4	7,1	5,8
Heating PL Condition D	PhD kW	4,0	3,5	4,0	3,5	4,0	3,5	4,0	3,5	4,0	3,5	4,0	3,5	6,7	6,0	6,9	6,2
	COPD	9,1	7,4	9,1	7,4	9,3	7,3	9,3	7,3	9,3	7,3	9,3	7,3	8,7	6,8	9,2	7,2
T bivalent	Tbiv °C	-10	-7	-10	-7	-7	-7	-7	-7	-7	-7	-7	-7	-7	-7	-7	-7
	PhTbiv kW	10,0	8,8	10,0	8,8	9,9	9,9	9,9	9,9	10,3	10,3	10,3	10,3	15,4	14,3	17,3	16,1
	COPTbiv	2,5	2,5	2,5	2,5	2,9	2,4	2,9	2,4	2,9	2,4	2,9	2,4	2,9	2,4	2,8	2,3
Psb	W	14,0	14,0	14,0	14,0	14,0	14,0	14,0	14,0	14,0	14,0	14,0	14,0	18,0	18,0	18,0	18,0
Psbh	W	14,0	14,0	14,0	14,0	14,0	14,0	14,0	14,0	14,0	14,0	14,0	14,0	18,0	18,0	18,0	18,0
Poffc	W	14,0	14,0	14,0	14,0	14,0	14,0	14,0	14,0	14,0	14,0	14,0	14,0	18,0	18,0	18,0	18,0
Poffh	W	14,0	14,0	14,0	14,0	14,0	14,0	14,0	14,0	14,0	14,0	14,0	14,0	18,0	18,0	18,0	18,0
Ptoc	W	18,0	18,0	18,0	18,0	18,0	18,0	18,0	18,0	18,0	18,0	18,0	18,0	26,0	26,0	26,0	26,0
Ptoh	W	18,0	18,0	18,0	18,0	18,0	18,0	18,0	18,0	18,0	18,0	18,0	18,0	26,0	26,0	26,0	26,0
Pckc	W	18,0	18,0	18,0	18,0	18,0	18,0	18,0	18,0	18,0	18,0	18,0	18,0	26,0	26,0	26,0	26,0
Pckh	W	18,0	18,0	18,0	18,0	18,0	18,0	18,0	18,0	18,0	18,0	18,0	18,0	26,0	26,0	26,0	26,0
Sound power level / in heating	dB(A)	69 / 72	—	69 / 72	—	70 / 74	—	70 / 74	—	72 / 75	—	72 / 75	—	72 / 74	—	74 / 75	—

**Eurovent VRF certified technical data: 2-Pipe ECOi EX MZ1 Series 8 to 12 HP · R32**

HP	8 HP			10 HP		12 HP		
	U-8MZ1E8		U-8MZ1E8	U-10MZ1E8		U-10MZ1E8	U-12MZ1E8	
Outdoor unit	4x S-56MU2		4x S-56MF3	4x S-73MU2		4x S-73MF3	6x S-56MU2	
Indoor units combination	4x S-56MU2		4x S-56MF3	4x S-73MU2		4x S-73MF3	6x S-56MU2	
S-**-MU2: S-**-MU2E5C	4x S-56MU2		4x S-56MF3	4x S-73MU2		4x S-73MF3	6x S-56MU2	
S-**-MF3: S-**-MF3E5D	4x S-56MU2		4x S-56MF3	4x S-73MU2		4x S-73MF3	6x S-56MU2	
Cooling	Pc out <sup>1)</sup> kW	22,40	18,10	28,00		22,70	33,50	
	Pec out <sup>2)</sup> kW	6,78	6,70	8,00		8,11	11,17	
	EERout	3,30	2,70	3,50		3,80	3,00	
Seasonal Cooling	SEER	7,27	5,20	7,82		5,62	7,37	
	η <sub>sc</sub> %	288,00	205,10	310,10		221,80	292,10	
Cooling PL Condition B	PcB kW	16,50	13,80	20,60		17,20	24,70	
	EERB	5,10	3,90	5,30		4,10	4,80	
Cooling PL Condition C	PcC kW	10,60	8,60	13,30		10,80	15,90	
	EERC	9,10	6,10	9,60		6,50	8,90	
Cooling PL Condition D	PcD kW	9,30	8,00	9,80		8,40	10,10	
	EERD	16,30	10,50	18,40		11,80	19,60	
Seasonal Heating	Pdesignh kW	16,30	13,20	20,50		16,50	24,40	
	SCOP	4,35	3,57	4,38		3,57	4,33	
	η <sub>sh</sub> %	171,00	140,10	172,40		139,80	170,30	
Heating PL Condition A	PhA kW	14,40	13,20	18,10		16,50	21,60	
	COPA	2,80	2,30	2,70		2,30	2,40	
Heating PL Condition B	PhB kW	8,70	7,90	11,00		9,90	13,10	
	COPB	4,10	3,50	4,00		3,30	4,00	
Heating PL Condition C	PhC kW	5,90	5,40	7,10		6,50	8,40	
	COPC	6,10	5,00	6,60		5,40	7,00	
Heating PL Condition D	PhD kW	6,90	6,90	7,40		7,40	6,80	
	COPD	7,50	6,80	8,50		7,70	8,20	
T bivalent	Tbiv °C	-10	-7	-10		-7	-10	
	PhTbiv kW	16,30	13,20	20,50		16,50	24,40	
	COPTbiv	2,40	2,30	2,40		2,30	2,10	
Psb	W	15,00	15,00	15,00		15,00	15,00	
Psbh	W	15,00	15,00	15,00		15,00	15,00	
Poffc	W	1,00	1,00	1,00		1,00	1,00	
Poffh	W	34,00	34,00	34,00		34,00	34,00	
Ptoc	W	24,00	24,00	24,00		24,00	24,00	
Ptoh	W	23,00	23,00	23,00		23,00	23,00	
Pckc	W	23,00	23,00	23,00		23,00	23,00	
Pckh	W	37,00	37,00	37,00		37,00	37,00	
Sound power level / in heating	dB(A)	75 / 75	75 / 75	77 / 77		77 / 77	81 / 84	

1) Pc out= Capacity. 2) Pec out= Input power. \* Please refer an official website (<https://www.eurovent-certification.com/en>) for each test condition.

## Eurovent VRF certified technical data

## Eurovent VRF certified technical data: Mini ECOi LE Series 4 to 10 HP - R410A

HP		4 HP				5 HP				6 HP				8 HP		10 HP	
Outdoor unit		U-4LE2E5		U-4LE2E8		U-5LE2E5		U-5LE2E8		U-6LE2E5		U-6LE2E8		U-8LE1E8		U-10LE1E8	
Indoor units combination		3x	3x	3x	3x	4x	4x	4x	4x	2x	2x	2x	2x	4x	4x	4x	4x
S-**MU2: S-**MU2E5C		S-28MU2,	S-28MF2,	S-28MU2,	S-28MF2,	S-36MU2	S-36MF2	S-36MU2	S-36MF2	S-36MU2,	S-36MF2,	S-36MU2,	S-36MF2,	S-56MU2	S-56MF2	S-73MU2	S-73MF2
S-**MF2: S-**MF2E5A		1x	1x	1x	1x					2x	2x	2x	2x				
		S-36MU2	S-36MF2	S-36MU2	S-36MF2					S-45MU2	S-45MF2	S-45MU2	S-45MF2				
Cooling	Pc out <sup>1)</sup> kW	12,1	12,1	12,1	12,1	14,0	14,0	14,0	14,0	15,5	15,5	15,5	15,5	22,4	22,4	28,0	28,0
	Pec out <sup>2)</sup> kW	2,9	2,9	2,9	2,9	3,7	3,7	3,7	3,7	4,6	4,6	4,6	4,6	7,2	7,2	10,8	10,8
	EERout	4,2	4,2	4,2	4,2	3,8	3,8	3,8	3,8	3,4	3,4	3,4	3,4	3,1	3,1	2,6	2,6
Seasonal Cooling	SEER	7,8	7,8	7,8	7,8	7,5	7,5	7,5	7,5	7,2	7,2	7,2	7,2	6,3	6,3	6,4	6,4
	η <sub>sc</sub> %	311,0	309,0	311,0	309,0	296,2	297,0	296,2	297,0	286,8	285,0	286,8	285,0	247,9	249,0	251,8	253,0
Cooling PL Condition B	PcB kW	8,9	8,9	8,9	8,9	10,3	10,3	10,3	10,3	11,4	11,4	11,4	11,4	16,5	16,5	20,6	20,6
	EERB	6,7	6,7	6,7	6,7	6,0	6,0	6,0	6,0	5,5	5,5	5,5	5,5	4,8	4,8	4,4	4,4
Cooling PL Condition C	PcC kW	5,7	5,7	5,7	5,7	6,6	6,6	6,6	6,6	7,3	7,3	7,3	7,3	10,6	10,6	13,2	13,2
	EERC	12,2	12,2	12,2	12,2	11,2	11,2	11,2	11,2	10,1	10,1	10,1	10,1	7,8	7,8	8,2	8,2
Cooling PL Condition D	PcD kW	2,6	2,6	2,6	2,6	2,9	2,9	2,9	2,9	3,4	3,4	3,4	3,4	8,0	8,0	9,0	9,0
	EERD	10,0	10,0	10,0	10,0	10,2	10,2	10,2	10,2	12,1	12,1	12,1	12,1	12,8	12,8	15,4	15,4
Seasonal Heating	Pdesignh kW	10,0	10,0	10,0	10,0	12,5	12,5	12,5	12,5	13,0	13,0	13,0	13,0	17,5	17,5	19,6	19,6
	SCOP	4,9	4,9	4,9	4,9	4,4	4,4	4,4	4,4	4,2	4,2	4,2	4,2	4,2	4,2	4,3	4,3
	η <sub>sh</sub> %	191,8	193,0	191,8	193,0	172,9	173,0	172,9	173,0	166,7	165,0	166,7	165,0	166,4	165,0	169,5	169,0
Heating PL Condition A	PhA kW	8,8	8,8	8,8	8,8	11,0	11,0	11,0	11,0	11,5	11,5	11,5	11,5	15,4	15,4	17,3	17,3
	COPA	3,5	3,5	3,5	3,5	2,8	2,8	2,8	2,8	2,6	2,6	2,6	2,6	2,7	2,7	2,6	2,6
Heating PL Condition B	PhB kW	5,3	5,3	5,3	5,3	6,7	6,7	6,7	6,7	7,0	7,0	7,0	7,0	9,4	9,4	10,5	10,5
	COPB	4,1	4,1	4,1	4,1	3,7	3,7	3,7	3,7	3,6	3,6	3,6	3,6	3,8	3,8	3,9	3,9
Heating PL Condition C	PhC kW	3,4	3,4	3,4	3,4	4,3	4,3	4,3	4,3	4,5	4,5	4,5	4,5	6,0	6,0	6,7	6,7
	COPC	7,7	7,7	7,7	7,7	7,5	7,5	7,5	7,5	7,4	7,4	7,4	7,4	6,6	6,6	6,8	6,8
Heating PL Condition D	PhD kW	4,0	4,0	4,0	4,0	4,0	4,0	4,0	4,0	4,0	4,0	4,0	4,0	6,4	6,4	6,6	6,6
	COPD	9,8	9,8	9,8	9,8	9,8	9,8	9,8	9,8	9,8	9,8	9,8	9,8	8,1	8,1	8,9	8,9
T bivalent	Tbiv °C	-10	-10	-10	-10	-9	-9	-9	-9	-7	-7	-7	-7	-7	-7	-7	-7
	PhTbiv kW	10,0	10,0	10,0	10,0	12,0	12,0	12,0	12,0	11,5	11,5	11,5	11,5	15,4	15,4	17,3	17,3
	COPTbiv	2,9	2,9	2,9	2,9	2,6	2,6	2,6	2,6	2,6	2,6	2,6	2,6	2,7	2,7	2,6	2,6
Psb	W	14,0	14,0	14,0	14,0	14,0	14,0	14,0	14,0	14,0	14,0	14,0	14,0	18,0	18,0	18,0	18,0
Poffc	W	14,0	14,0	14,0	14,0	14,0	14,0	14,0	14,0	14,0	14,0	14,0	14,0	18,0	18,0	18,0	18,0
Ptoc	W	34,0	34,0	34,0	34,0	34,0	34,0	34,0	34,0	34,0	34,0	34,0	34,0	48,0	48,0	48,0	48,0
Pckc	W	34,0	34,0	34,0	34,0	34,0	34,0	34,0	34,0	34,0	34,0	34,0	34,0	48,0	48,0	48,0	48,0
Psbh	W	38,0	38,0	38,0	38,0	38,0	38,0	38,0	38,0	38,0	38,0	38,0	38,0	48,0	48,0	48,0	48,0
Poffh	W	38,0	38,0	38,0	38,0	38,0	38,0	38,0	38,0	38,0	38,0	38,0	38,0	48,0	48,0	48,0	48,0
Ptoh	W	38,0	38,0	38,0	38,0	38,0	38,0	38,0	38,0	38,0	38,0	38,0	38,0	48,0	48,0	48,0	48,0
Pckh	W	38,0	38,0	38,0	38,0	38,0	38,0	38,0	38,0	38,0	38,0	38,0	38,0	48,0	48,0	48,0	48,0
Sound power level / in heating		dB(A)	69 / 72	—	69 / 72	—	71 / 75	—	71 / 75	—	73 / 75	—	73 / 75	—	79 / 83	—	83 / 84

## Eurovent VRF certified technical data: 2-Pipe ECOi EX ME2 Series 8 to 20 HP - R410A

HP		8 HP		10 HP		12 HP		14 HP		16 HP		18 HP		20 HP	
Outdoor unit		U-8ME2E8		U-10ME2E8		U-12ME2E8		U-14ME2E8		U-16ME2E8		U-18ME2E8		U-20ME2E8	
Indoor units combination		4x	4x	4x	4x	6x	6x	2x	2x	6x	6x	6x	6x	8x	8x
S-**MU2: S-**MU2E5C		S-56MU2	S-56MF2	S-73MU2	S-73MF2	S-56MU2	S-56MF2	S-60MU2,	S-60MF2,	S-73MU2	S-73MF2	S-60MU2,	S-60MF2,	S-73MU2	S-73MF2
S-**MF2: S-**MF2E5A								4x	4x			2x	2x		
								S-73MU2	S-73MF2			S-73MU2	S-73MF2		
Cooling	Pc out <sup>1)</sup> kW	19,7	19,7	24,6	24,6	33,5	33,5	40,0	40,0	45,0	45,0	50,0	50,0	56,0	56,0
	Pec out <sup>2)</sup> kW	5,8	5,8	8,8	8,8	11,6	11,6	13,3	13,3	18,8	18,8	17,9	17,9	23,3	23,3
	EERout	3,4	3,4	2,8	2,8	2,9	2,9	3,0	3,0	2,4	2,4	2,8	2,8	2,4	2,4
Seasonal Cooling	SEER	7,4	7,4	7,0	7,0	6,7	6,7	7,2	7,2	6,4	6,4	7,6	7,6	7,0	7,0
	η <sub>sc</sub> %	294,3	293,0	275,4	277,0	266,6	265,0	286,0	285,0	254,3	253,0	299,2	301,0	278,2	277,0
Cooling PL Condition B	PcB kW	14,5	14,5	18,1	18,1	24,6	24,6	29,4	29,4	33,1	33,1	36,8	36,8	41,2	41,2
	EERB	5,7	5,7	4,8	4,8	4,6	4,6	4,9	4,9	4,2	4,2	5,0	5,0	4,6	4,6
Cooling PL Condition C	PcC kW	9,3	9,3	11,6	11,6	15,8	15,8	18,9	18,9	21,3	21,3	23,6	23,6	26,5	26,5
	EERC	11,8	11,8	9,6	9,6	8,1	8,1	9,4	9,4	8,2	8,2	9,8	9,8	9,0	9,0
Cooling PL Condition D	PcD kW	8,2	8,2	9,3	9,3	8,2	8,2	8,4	8,4	9,4	9,4	10,5	10,5	11,7	11,7
	EERD	13,7	13,7	18,9	18,9	18,4	18,4	22,6	22,6	22,1	22,1	25,2	25,2	24,6	24,6
Seasonal Heating	Pdesignh kW	17,5	17,5	22,0	22,0	26,2	26,2	31,5	31,5	35,0	35,0	39,2	39,2	44,1	44,1
	SCOP	4,8	4,8	4,3	4,3	4,7	4,7	4,3	4,3	4,1	4,1	4,3	4,3	4,1	4,1
	η <sub>sh</sub> %	188,4	189,0	167,6	169,0	185,8	185,0	168,2	169,0	159,0	161,0	168,7	169,0	160,4	161,0
Heating PL Condition A	PhA kW	15,4	15,4	19,4	19,4	23,1	23,1	27,8	27,8	30,9	30,9	34,6	34,6	39,0	39,0
	COPA	2,8	2,8	2,6	2,6	2,8	2,8	2,5	2,5	2,3	2,3	2,6	2,6	2,4	2,4
Heating PL Condition B	PhB kW	9,4	9,4	11,8	11,8	14,1	14,1	16,9	16,9	18,8	18,8	21,1	21,1	23,7	23,7
	COPB	4,5	4,5	3,6	3,6	4,2	4,2	3,7	3,7	3,6	3,6	3,7	3,7	3,5	3,5
Heating PL Condition C	PhC kW	6,0	6,0	7,6	7,6	9,0	9,0	10,9	10,9	12,1	12,1	13,5	13,5	15,2	15,2
	COPC	7,2	7,2	7,7	7,7	7,7	7,7	7,4	7,4	6,6	6,6	7,1	7,1	6,9	6,9
Heating PL Condition D	PhD kW	7,1	7,1	7,0	7,0	7,2	7,2	6,7	6,7	6,6	6,6	7,4	7,4	7,4	7,4
	COPD	8,9	8,9	9,6	9,6	9,3	9,3	10,2	10,2	10,0	10,0	10,3	10,3	10,3	10,3
T bivalent	Tbiv °C	-9	-9	-7	-7	-9	-9	-7	-7	-7	-7	-7	-7	-7	-7
	PhTbiv kW	16,8	16,8	19,4	19,4	25,1	25,1	27,8	27,8	30,9	30,9	34,6	34,6	39,0	39,0
	COPTbiv	2,6	2,6	2,6	2,6	2,6	2,6	2,5	2,5	2,3	2,3	2,6	2,6	2,4	2,4
Psb	W	48,0	48,0	48,0	48,0	48,0	48,0	88,0	88,0	88,0	88,0	88,0	88,0	88,0	88,0
Psbh	W	48,0	48,0	48,0	48,0	48,0	48,0	88,0	88,0	88,0	88,0	88,0	88,0	88,0	88,0
Poffc	W	48,0	48,0	48,0	48,0	48,0	48,0	88,0	88,0	88,0	88,0	88,0	88,0	88,0	88,0
Poffh	W	48,0	48,0	48,0	48,0	48,0	48,0	88,0	88,0	88,0	88,0				



## Eurovent VRF certified technical data: 3-Pipe ECOi EX MF3 Series 8 to 16 HP · R410A

HP		8 HP		10 HP		12 HP		14 HP		16 HP	
Outdoor unit		U-8MF3E8		U-10MF3E8		U-12MF3E8		U-14MF3E8		U-16MF3E8	
Indoor units combination		4x S-56MU2	4x S-56MF2	4x S-73MU2	4x S-73MF2	6x S-56MU2	6x S-56MF2E	2x S-60MU2, 4x S-73MU2	2x S-60MF2, 4x S-73MF2	6x S-73MU2	6x S-73MF2
S-**MU2: S-**MU2E5C											
S-**MF2: S-**MF2E5A											
Cooling	Pc out <sup>1)</sup> kW	22,4	22,4	28,0	28,0	33,5	33,5	40,0	40,0	45,0	45,0
	Pec out <sup>2)</sup> kW	7,2	7,2	10,8	10,8	12,9	12,9	15,4	15,4	19,6	19,6
	EERout	3,1	3,1	2,6	2,6	2,6	2,6	2,6	2,6	2,3	2,3
Seasonal Cooling	SEER	7,0	7,0	7,0	7,0	6,4	6,4	6,7	6,7	6,0	6,0
	η <sub>sc</sub> %	277,7	277,0	278,9	277,0	252,7	253,0	264,4	265,0	237,7	237,0
Cooling PL Condition B	PcB kW	16,5	16,5	20,6	20,6	24,6	24,6	29,4	29,4	33,1	33,1
	EERB	4,9	4,9	4,6	4,6	4,3	4,3	4,4	4,4	3,9	3,9
Cooling PL Condition C	PcC kW	10,6	10,6	13,2	13,2	15,8	15,8	18,9	18,9	21,3	21,3
	EERC	9,1	9,1	9,3	9,3	7,7	7,7	8,3	8,3	7,4	7,4
Cooling PL Condition D	PcD kW	7,2	7,2	8,5	8,5	7,1	7,1	8,5	8,5	9,4	9,4
	EERD	16,5	16,5	19,7	19,7	15,7	15,7	19,7	19,7	17,4	17,4
Seasonal Heating	Pdesignh kW	17,5	17,5	22,0	22,0	26,2	26,2	31,5	31,5	35,0	35,0
	SCOP	4,8	4,8	4,2	4,2	4,3	4,3	4,1	4,1	3,8	3,8
	η <sub>sh</sub> %	190,9	189,0	166,8	165,0	167,8	169,0	162,1	161,0	149,3	149,0
Heating PL Condition A	PhA kW	15,4	15,4	19,4	19,4	23,1	23,1	27,8	27,8	30,9	30,9
	COPA	2,9	2,9	2,5	2,5	2,7	2,7	2,4	2,4	2,2	2,2
Heating PL Condition B	PhB kW	9,4	9,4	11,8	11,8	14,1	14,1	16,9	16,9	18,8	18,8
	COPB	4,6	4,6	3,7	3,7	3,7	3,7	3,6	3,6	3,3	3,3
Heating PL Condition C	PhC kW	6,0	6,0	7,6	7,6	9,0	9,0	10,9	10,9	12,1	12,1
	COPC	7,1	7,1	7,4	7,4	6,9	6,9	7,1	7,1	6,5	6,5
Heating PL Condition D	PhD kW	6,7	6,7	6,9	6,9	6,5	6,5	6,6	6,6	6,6	6,6
	COPD	8,7	8,7	9,4	9,4	9,0	9,0	9,6	9,6	9,6	9,6
T bivalent	Tbiv °C	-9	-9	-7	-7	-9	-9	-7	-7	-7	-7
	PhTbiv kW	16,8	16,8	19,4	19,4	25,1	25,1	27,8	27,8	30,9	30,9
	COPTbiv	2,6	2,6	2,5	2,5	2,3	2,3	2,4	2,4	2,2	2,2
Psbv	W	17,0	17,0	17,0	17,0	17,0	17,0	25,0	25,0	25,0	25,0
Poffc	W	17,0	17,0	17,0	17,0	17,0	17,0	25,0	25,0	25,0	25,0
Ptacc	W	17,0	17,0	17,0	17,0	17,0	17,0	25,0	25,0	25,0	25,0
Pckc	W	50,0	50,0	50,0	50,0	50,0	50,0	91,0	91,0	91,0	91,0
Psbh	W	50,0	50,0	50,0	50,0	50,0	50,0	91,0	91,0	91,0	91,0
Poffh	W	50,0	50,0	50,0	50,0	50,0	50,0	91,0	91,0	91,0	91,0
Ptoh	W	50,0	50,0	50,0	50,0	50,0	50,0	91,0	91,0	91,0	91,0
Pckh	W	50,0	50,0	50,0	50,0	50,0	50,0	91,0	91,0	91,0	91,0
Sound power level / in heating	dB(A)	79 / 77	—	80 / 82	—	84 / 86	—	86 / 86	—	86 / 88	—



## Panasonic ventilation solutions

Panasonic ventilation solutions for maximum savings and easy integration.



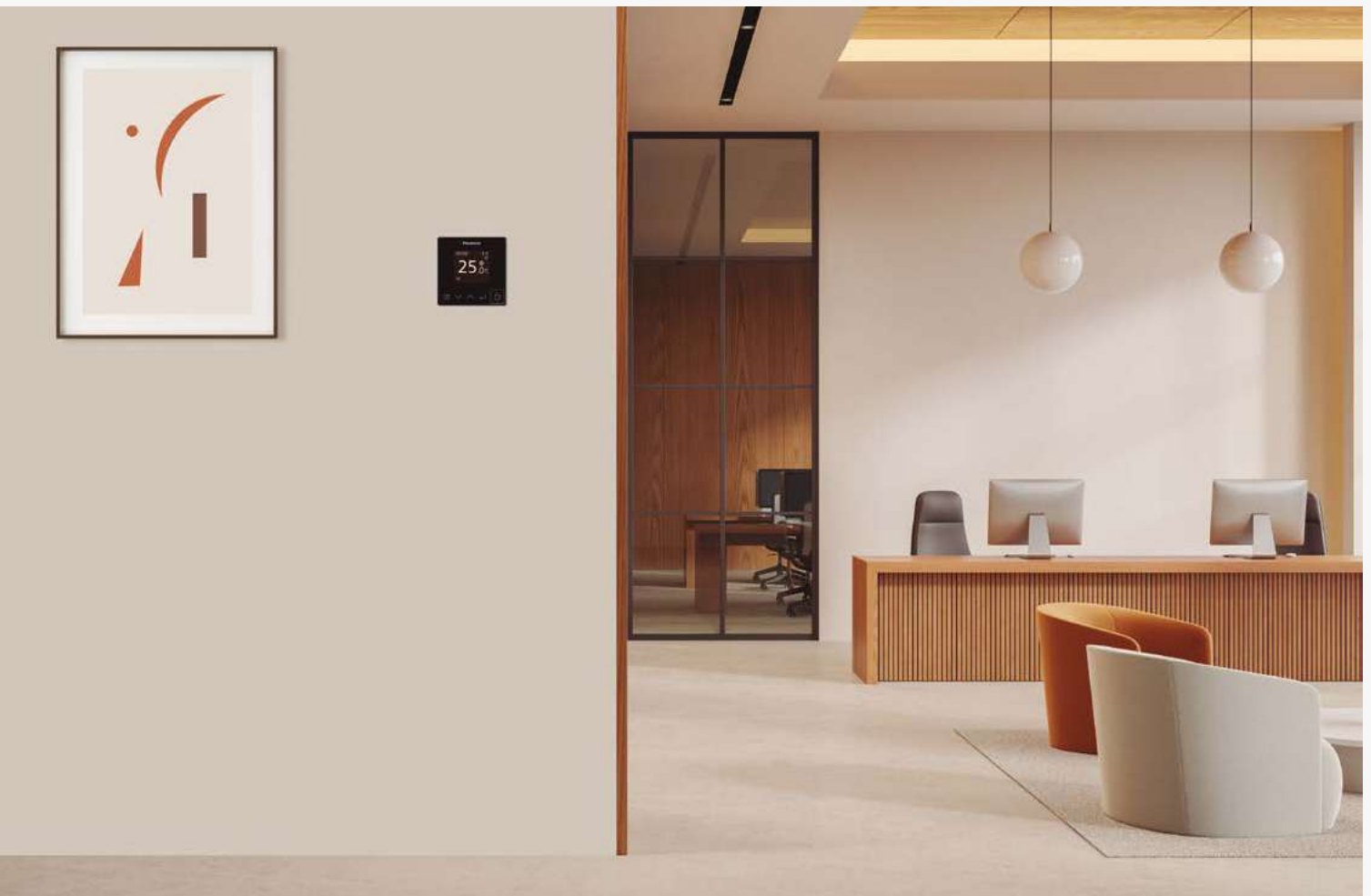

### **Air handling unit kit** → 398

AHU connection kit PAH3M-1 for PACi NX → 400

AHU connection kit MAH4M for ECOi 2-Pipe → 402

AHU connection kit MAH3M for ECOi and ECO G → 404

### **Advanced energy recovery ventilation - ZY Series** → 406

Advanced energy recovery ventilation - ZY Series → 407

### **Energy recovery ventilation with DX coil - HRPT Series for VRF** → 408

Energy recovery ventilation with DX coil - HRPT Series · R32 / R410A → 409

### **Electric air curtains** → 410

Electric air curtain → 410

Air curtain with DX coil, connected to PACi NX → 412

Air curtain with DX coil, connected to VRF systems → 413

### **High pressure duct and 100% fresh air duct function** → 414

E2 type high static pressure hide-away · R410A → 415

### **Ceiling mounted air-e nanoe X Generator** → 416

Ceiling mounted air-e nanoe X Generator → 417

### **Residential ventilation**

Heat recovery ventilation unit → 418

Aquarea Vent - Counter flow ventilation → 420

## Air handling unit kit

AHU connection kits connect outdoor units to air handling systems. Combines air conditioning and fresh air in just one solution.

Application: Hotels, offices, server rooms or all large buildings where air quality control, such as humidity control and fresh air, is needed.



### AHU connection kit PAH3M-1 for PACi NX (2,5 - 23,2 kW\*).

- Durable metal casing (IP 65) allows external installation
- 0-10 V demand control
- CONEX Bluetooth® control built-in (CZ-RTC6BL)
- Panasonic H&C Control App via Bluetooth®
- Easy integration to BMS

\* Nominal cooling capacity.



### AHU connection kit MAH4M for ECOi 2-Pipe (16 - 96 kW\*).

- Space-saving compact casing
- 0-10 V demand control
- Built-in controller for daily functions and service levels
- Direct Modbus communication without an additional interface
- Easy integration to BMS
- Accurate control with a pressure transducer

\* Nominal cooling capacity.



### AHU connection kit MAH3M for ECOi and ECO G (14 - 224 kW\*).

- Durable metal casing (IP 65) allows external installation
- 0-10 V demand control
- CONEX Bluetooth® control built-in (CZ-RTC6BL)
- Panasonic H&C Control App via Bluetooth®
- Easy integration to BMS

\* Nominal cooling capacity.



### AHU connection kit line-up.

AHU connection kit	Reference	Casing	Controller	0-10 V demand control	Compatible outdoor units
<b>PAH3M-1</b>	PAW-280PAH3M-1	Durable metal casing (IP 65)	CONEX Bluetooth® control (CZ-RTC6BL)	Yes	PACi NX
<b>MAH4M</b>	PAW-P+100MAH4M	Durable metal casing (IP 65)	Built-in c.pCO controller	Yes	Mini ECOi and ECOi EX 2-Pipe
<b>MAH3M</b>	PAW-160MAH3M PAW-280MAH3M PAW-560MAH3M	Durable metal casing (IP 65)	CONEX Bluetooth® control (CZ-RTC6BL)	Yes	Mini ECOi, all ECOi EX and all ECO G

# AHU connection kit PAH3M-1 for PACi NX

Compatible with R32 or R410A outdoor units.

The Panasonic AHU connection kits offer a wealth of connectivity possibilities, integrating easily into many systems.

Besides the advantages in terms of indoor air quality, air conditioning offers also an energy saving potential. For example, uncontrolled ventilation through open windows leads to large amounts of heat being lost to the outside during the heating season or gained from the outside during the cooling season. Whereas, combining heat recovery with air conditioning can allow for a high level of comfort whilst reducing the overall operating costs of running air conditioning alone. The larger area of the comfort range, the better the energy saving opportunities.

## System example with AHU connection kit PAH3M-1 and PACi NX outdoor unit

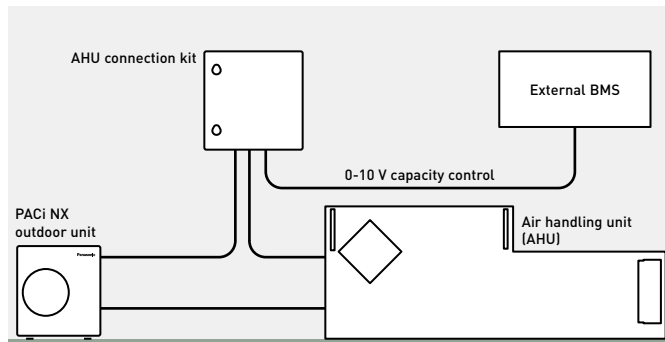

Demand control on the outdoor unit managed by external 0-10 V signal.

- AHU connection kit contains: IP 65 box with PCBs and terminal connections mounted inside, expansion valve and sensors
- Heat exchanger, fan and fan motor to be mounted in the AHU itself are field supplied

## Main components of mechanical ventilation systems

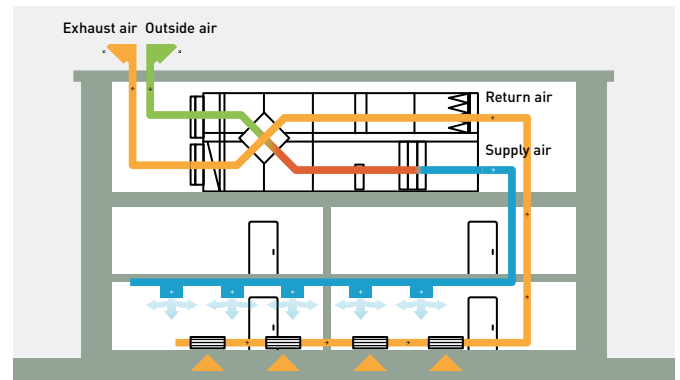

- Air handling unit (AHU)
- Air ducts
- Air distribution elements

## Control options

### Control option 1.

- The system's control is simple: control of actual suction temperature vs. set point
- Control works in the same way as that of any indoor unit
- Fan signal issued by the PCB (OFF while defrosting, for instance)

### Control option 2.

- System control by a 0-10 V control working from an external BMS that manages the set point for temperature or capacity. Enhances efficiency by adjusting capacity and enhances comfort as well
- All signals as standard

## 0-10 V control

With the 0-10 V demand control the capacity of the outdoor unit can be controlled by 20 steps.

Input voltage* [V]	0	1,0	1,5	2,0	2,5	3,0	3,5	4,0	4,5	5,0	5,5	6,0	6,5	7,0	7,5	8,0	8,5	9,0	9,5	
Demand [% of nominal current]	No cut <sup>1)</sup>	40	45	50	55	60	65	70	75	80	85	90	95	100	105	110	115	120	No limit / Full capacity <sup>2)</sup>	
Indoor unit start / stop	Stop <sup>1)</sup>										Start									

1) No cut / stop: AHU system / indoor unit is completely switched OFF.

2) No limit: No restrictions applied by BMS to AHU system / indoor unit performance (equivalent to "full-load operation" of AHU system / indoor unit).

## AHU connection kit.

**PCB, power trans, terminal block.**



**Thermistor x2 (refrigerant: E1, E2).**



**Thermistor (air: TA; 1 sensor).**



**Wired remote controller. CZ-RTC6BL.**



## Optional controller.

**Timer remote controller. CZ-RTC5B.**





AHU connection kit PAH3M-1 for PACi NX



PACi



CONEX Bluetooth® control built-in. CZ-RTC6BL



PAW-280PAH3M-1			2,5 kW	3,6 kW	5,0 kW	6,0 kW	7,5 kW	10,0 kW	12,5 kW	14,0 kW	20,0 kW	25,0 kW
Dimension	HxWxD	mm	500x400x150	500x400x150	500x400x150	500x400x150	500x400x150	500x400x150	500x400x150	500x400x150	500x400x150	500x400x150
Net weight		kg	11,5	11,5	11,5	11,5	11,5	11,5	11,5	11,5	11,5	11,5
Piping diameter	Liquid	Inch (mm)	1/4 (6,35)	1/4 (6,35)	1/4 (6,35)	3/8 (9,52)	3/8 (9,52)	3/8 (9,52)	3/8 (9,52)	3/8 (9,52)	3/8 (9,52)	1/2 (12,70)
	Gas	Inch (mm)	1/2 (12,70)	1/2 (12,70)	1/2 (12,70)	5/8 (15,88)	5/8 (15,88)	5/8 (15,88)	5/8 (15,88)	5/8 (15,88)	1 (25,40)	1 (25,40)
Intake temperature of AHU connection kit	Cool Min ~ Max	°C DB	18~32	18~32	18~32	18~32	18~32	18~32	18~32	18~32	18~32	18~32
	Cool Min ~ Max	°C WB	14~25	14~25	14~25	14~25	14~25	14~25	14~25	14~25	—	—
	Heat Min ~ Max	°C	16~30	16~30	16~30	16~30	16~30	16~30	16~30	16~30	16~30	16~30
<b>With PACi NX Elite</b>												
Cooling capacity		kW	—	3,6	5,0	6,0	7,1	10,0	12,5	14,0	19,0	22,0
Heating capacity		kW	—	4,0	5,6	7,0	8,0	11,2	14,0	16,0	22,4	24,0
Air flow	Min / Max	m³/h	—	540/870	630/990	780/1320	780/1320	900/2160	1140/2280	1200/2400	2160/8000	2160/9000
Pipe length range		m	—	3~40	3~40	3~40	5~50	5~85	5~85	5~85	5~100	5~100
Elevation difference (in / out)	Max	m	—	30	30	30	30	30	30	30	30	30
Ambient temperature of outdoor unit	Cool Min ~ Max	°C	—	-15~+46	-15~+46	-15~+46	-15~+46	-20~+48	-20~+48	-20~+48	-15~+52	-15~+52
	Heat Min ~ Max	°C	—	-20~+24	-20~+24	-20~+24	-20~+24	-20~+24	-20~+24	-20~+24	-20~+35	-20~+35
<b>With PACi NX Standard</b>												
Cooling capacity		kW	2,5	3,6	5,0	6,0	7,1	10,0	12,5	14,0	—	—
Heating capacity		kW	3,2	4,0	5,0	6,0	7,1	10,0	12,5	14,0	—	—
Air flow	Min / Max	m³/h	360 / 570	540/870	630/990	780/1320	780/1320	900/2160	1140/2280	1200/2400	—	—
Pipe length range		m	3~15	3~15	3~20	3~40	3~40	5~50	5~50	5~50	—	—
Elevation difference (in / out)	Max	m	30	30	30	30	30	30	30	30	—	—
Ambient temperature of outdoor unit	Cool Min ~ Max	°C	-10~+43	-10~+43	-10~+43	-10~+43	-10~+43	-10~+43	-10~+43	-10~+43	—	—
	Heat Min ~ Max	°C	-15~+24	-15~+24	-15~+24	-15~+24	-15~+24	-15~+24	-15~+24	-15~+24	—	—

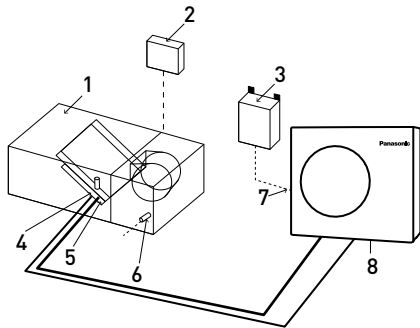

System and regulations. System overview.

- 1 | AHU equipment (field supplied)
- 2 | AHU system controller (field supplied)
- 3 | AHU connection kit controller box (with control PCB)
- 4 | Thermistor for gas pipe (E2)
- 5 | Thermistor for liquid pipe (E1)
- 6 | Thermistor for suction air
- 7 | Inter-unit wiring
- 8 | Outdoor unit

Outdoor unit	Air flow volume m³/min																																					
	360	510	540	570	630	720	780	870	900	960	990	1.080	1.170	1.200	1.320	1.450	1.500	1.600	1.740	1.800	1.900	2.000	2.160	2.280	2.300	2.400	2.520	2.610	2.640	2.800	2.970	3.000	3.480	3.600				
<b>PACi NX Elite</b>																																						
U-36PZH3E5	■																																					
U-50PZH3E5	■	■																																				
U-60PZH3E5	■	■	■																																			
U-71PZH4E5/8	■	■	■	■																																		
U-100PZH4E5/8	■	■	■	■	■																																	
U-125PZH4E5/8	■	■	■	■	■	■																																
U-140PZH4E5/8	■	■	■	■	■	■	■																															
<b>PACi NX Standard</b>																																						
U-25PZ3E5	■	■																																				
U-36PZ3E5	■	■	■																																			
U-50PZ3E5	■	■	■	■																																		
U-60PZ3E5	■	■	■	■	■																																	
U-71PZ3E5	■	■	■	■	■	■																																
U-100PZ3E5/8	■	■	■	■	■	■	■																															
U-125PZ3E5/8	■	■	■	■	■	■	■	■																														
U-140PZ3E5/8	■	■	■	■	■	■	■	■	■																													

■ Maximum allowed air volume flow under "Standard conditions". ■ Higher maximum allowed air volume flow under "Special conditions" <sup>1)</sup>: Maximum allowed air intake temperature at AHU DX coil heat exchanger in cooling mode is restricted to 30 °C DB.

1) Using an AHU unit with a higher maximum allowed air volume flow is subject to a restriction of the "Air intake temperature" to 30 °C DB (instead of 32 °C WB under standard conditions).

# AHU connection kit MAH4M for ECOi 2-Pipe



## System example with AHU connection kit MAH4M and Mini ECOi outdoor unit

- AHU connection kit in an IP 65 casing, contains PCBs and terminal connections mounted inside
- Select the size of the expansion valve pack based on the capacity
- Direct Modbus communication with a built-in Modbus S-Link interface
- The heat exchanger, fan, and fan motor to be mounted in the AHU are field-supplied

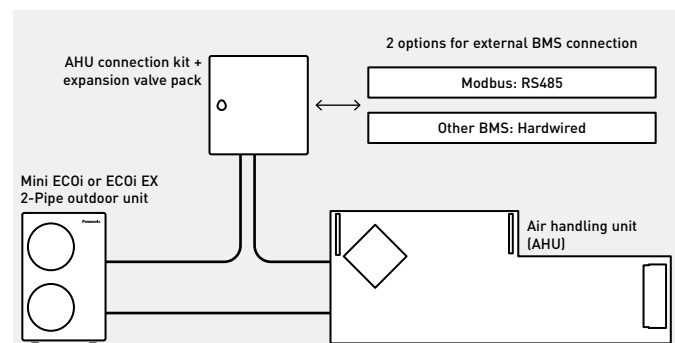

Demand control on the outdoor unit managed by external 0-10 V signal.

## 0-10 V control

With 0-10 V demand control, the outdoor unit capacity can be adjusted in each 5% demand step. Temperature set control (default discharge temperature control) is also available in each 0,5 K step.

Input voltage* [V]	0	1,0	1,5	2,0	2,5	3,0	3,5	4,0	4,5	5,0	5,5	6,0	6,5	7,0	7,5	8,0	8,5	9,0	9,5
Demand [% of nominal current]	No cut <sup>1)</sup>	40	45	50	55	60	65	70	75	80	85	90	95	100	105	110	115	120	No limit / Full capacity <sup>2)</sup>
Indoor unit start / stop	Stop <sup>1)</sup>														Start				

1) No cut / stop: AHU system / indoor unit is completely switched OFF.

2) No limit: No restrictions applied by BMS to AHU system / indoor unit performance [equivalent to "full-load operation" of AHU system / indoor unit].

## Accessories highlights.

### Remote control pack.

PAW-P+100PGNEPACK.  
Graphic display remote control, managing both icons and international fonts.



### EEV (Electric expansion valve) pack.

EEV controls refrigerant circuit superheat (or subcooling), directly managed by the c.pCO mini controller. Different sizes based on capacity.

EEV pack 1 ≤ 16,0 kW	PAW-P+116EEVPACK
EEV pack 2 ≤ 33,0 kW	PAW-P+133EEVPACK
EEV pack 3 ≤ 45,0 kW	PAW-P+145EEVPACK
EEV pack 4 ≤ 61,5 kW	PAW-P+156EEVPACK
EEV pack 5 ≤ 96,0 kW	PAW-P+174EEVPACK

\* Example image.



**AHU connection kit MAH4M for ECOi 2-Pipe**

Space-saving compact casing.  
Direct Modbus communication without the need for an additional interface.  
Accurate control with a pressure transducer.



Built-in controller.



PAW-P+100MAH4M			6 HP	12 HP	16 HP	18 HP	20 HP	22 HP	24 HP	34 HP <sup>1)</sup>
Cooling capacity	Nominal	kW	16,0	33,5	45,0	50,0	56,0	61,5	68,0	96,0
Heating capacity	Nominal	kW	17,0	37,5	50,0	56,0	63,0	69,0	76,5	108,0
Air flow	Min / Max	m <sup>3</sup> /h	1800/4400	2000/10000	3500/12000	5000 / 20000	5000 / 20000	5000 / 20000	6000 / 24000	8500 / 32000
Dimension	H x W x D	mm	300 x 400 x 150	300 x 400 x 150	300 x 400 x 150	300 x 400 x 150	300 x 400 x 150	300 x 400 x 150	300 x 400 x 150	300 x 400 x 150
Weight		kg	11	11	11	11	11	11	11	11
Pipe length range		m	10 ~ 100	10 ~ 100	10 ~ 100	10 ~ 100	10 ~ 100	10 ~ 100	10 ~ 100	10 ~ 100
Elevation difference (in / out)		m	10	10	10	10	10	10	10	10
Piping diameter ≤ 90 m	Liquid	Inch (mm)	3/8 (9,52)	1/2 (12,70)	1/2 (12,70)	5/8 (15,88)	5/8 (15,88)	5/8 (15,88)	5/8 (15,88)	3/4 (19,05)
	Gas	Inch (mm)	5/8 (15,88)	1 (25,40)	1 1/8 (28,57)	1 1/8 (28,57)	1 1/8 (28,57)	1 1/8 (28,57)	1 1/8 (28,57)	1 1/4 (31,75)
Piping diameter > 90 m <sup>2)</sup>	Liquid	Inch (mm)	—	5/8 (15,88)	5/8 (15,88)	3/4 (19,05)	3/4 (19,05)	3/4 (19,05)	3/4 (19,05)	7/8 (22,22)
	Gas	Inch (mm)	—	1 1/8 (28,57)	1 1/4 (31,75)	1 1/4 (31,75)	1 1/4 (31,75)	1 1/4 (31,75)	1 1/4 (31,75)	1 1/2 (38,10)

1) High-efficiency combination: U-10ME2E8 + 2xU-12ME2E8. 2) For R410A models only.

AHU connection kit / system combination						
Cooling capacity	Mini VRF		2-Pipe VRF		AHU connection kit	EEV pack
	Mini ECOi LZ2 Series (R32)	Mini ECOi LE Series (R410A)	ECOi EX ME2 Series			
4 ~ 6 HP	U-4LZ2E5(8) / U-5LZ2E5(8) / U-6LZ2E5(8)	U-4LE2E5(8) / U-5LE2E5(8) / U-6LE2E5(8)	—		PAW-P+100MAH4M	PAW-P+116EEVPACK
8 ~ 12 HP	U-8LZ2E8 / U-10LZ2E8	U-8LE1E8 / U-10LE1E8	U-8ME2E8 / U-10ME2E8 / U-12ME2E8		PAW-P+100MAH4M	PAW-P+133EEVPACK
14 ~ 18 HP	—	—	U-14ME2E8 / U-16ME2E8 / U-18ME2E8		PAW-P+100MAH4M	PAW-P+145EEVPACK
20 ~ 22 HP	—	—	20 HP (2xU-10ME2E8) 22 HP (U-10ME2E8 + U-12ME2E8)		PAW-P+100MAH4M	PAW-P+156EEVPACK
24 ~ 34 HP	—	—	24 HP (2xU-12ME2E8) 34 HP*		PAW-P+100MAH4M	PAW-P+174EEVPACK

\* Multiple combinations available.

Accessories	
<b>PAW-P+102SENSPACK</b>	AHU connection kit sensor pack 1 (2 pcs of SENSOR PT1000 HT IP67 -50/250 CABLE 6 m PCK)
<b>PAW-P+116EEVPACK</b>	EEV pack 1 (1 pc of expansion valve ≤ 16,0 kW (R410A / R32) and 1 pc of UNIPOLAR stator)
<b>PAW-P+133EEVPACK</b>	EEV pack 2 (1 pc of expansion valve ≤ 33,0 kW (R410A / R32) and 1 pc of UNIPOLAR stator)
<b>PAW-P+145EEVPACK</b>	EEV pack 3 (1 pc of expansion valve ≤ 45,0 kW (R410A / R32) and 1 pc of UNIPOLAR stator)

Accessories	
<b>PAW-P+156EEVPACK</b>	EEV pack 4 (1 pc of expansion valve ≤ 61,5 kW (R410A / R32) and 1 pc of UNIPOLAR stator)
<b>PAW-P+174EEVPACK</b>	EEV pack 5 (1 pc of expansion valve ≤ 96,0 kW (R410A / R32) and 1 pc of UNIPOLAR stator)
<b>PAW-P+100PGNEPACK</b>	Remote control pack (1 pc of PGNE 132 x 64 mm, mounting panel and 1 pc of cable L= 1,5 m, telephone connectors)

**Technical focus**

- Maximum capacity / system: 34 HP (96 kW\*)
- Selectable expansion valve packs depending on the capacity
- DC 12 V outlet available without optional interface
- Maximum elevation difference indoor/outdoor unit: 10 m
- Elevation difference (indoor unit / indoor unit): 4 m
- In / out connection capacity ratio: 50~100%
- Maximum number of AHU connection kits: 1 unit
- Outdoor temperature range in heating: -20 ~ +15 °C
- Available temperature range for the suction air at AHU connection kit: cool: +18 ~ +32 °C / heat: +16 ~ +30 °C
- The system's set temperature can be selected either as the default setting discharge air temperature (supply room temperature) or the suction air set temperature (or room return air temperature)
- Accurate control with a pressure transducer
- Direct Modbus communication with a built-in Modbus S-Link interface
- Various technical parameters available with Modbus
- SG Ready fulfilled. Demand input can be set Thermostat OFF or 40 - 200% by the user

- Defrost operation signal, compressor status ON / OFF output
- Display an error message concerning drain water overflow
- Connectable with S-Link system. Special care for electrical noise may be necessary depending on the on-site system
- Fan control signal output to manage the air flow (ON / OFF)
- Alarm status monitoring output

\* Nominal cooling capacity.

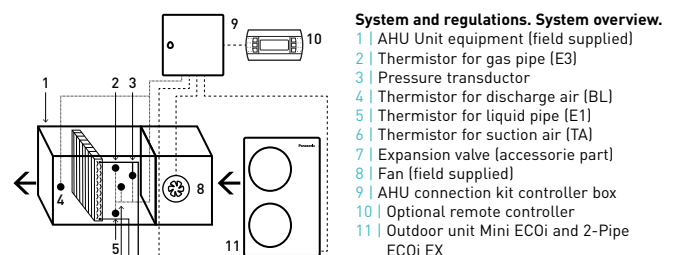

# AHU connection kit MAH3M for ECOi and ECO G



## With ECOi outdoor units

ECOi outdoor units shall be used for AHU connection kit. 3 models for VRF system: 5 HP (PAW-160MAH3M), 10 HP (PAW-280MAH3M) and 20 HP (PAW-560MAH3M).

## With ECO G outdoor units

- One AHU connection kit may be used for one ECO G unit. Multiple AHU connection kits cannot be used
- Mixed with standard indoor units is not allowed
- Power specifications are single phase 220 V to 240 V

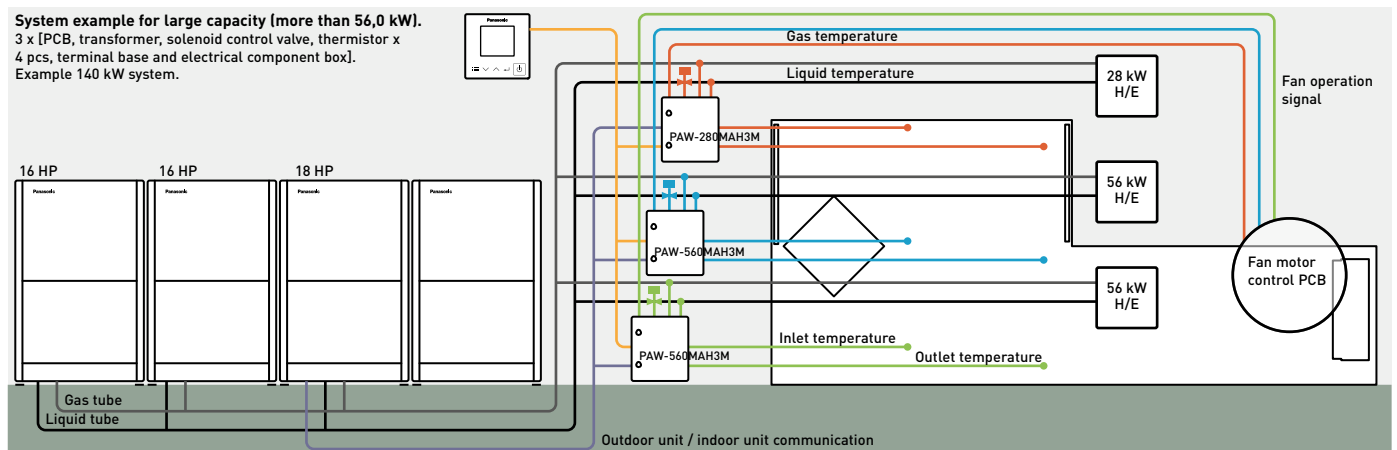

AHU connection kit MAH3M for ECOi and ECO G



CONEX Bluetooth® control built-in. CZ-RTC6BL



ECO i EX / ECO i / ECO G

Model	PAW-	5 HP	10 HP	20 HP	30 HP	40 HP	50 HP	60 HP	70 HP	80 HP
		160MAH3M	280MAH3M	560MAH3M	280MAH3M 560MAH3M	560MAH3M	560MAH3M 280MAH3M	560MAH3M 560MAH3M	560MAH3M 560MAH3M	560MAH3M 280MAH3M
Cooling capacity	kW	14,0	28,0	56,0	84,0	112,0	140,0	168,0	196,0	224,0
Heating capacity	kW	16,0	31,5	63,0	95,0	127,0	155,0	189,0	219,0	252,0
Air flow	Cool Min/Max m³/h	1140/2598	3498/4998	7002/10002	10500/15000	13998/19998	17496/24996	21000/30000	35000/24000	40000/28000
Bypass factor recommended		0,9	0,9	0,9	0,9	0,9	0,9	0,9	0,9	0,9
Dimension	HxWxD mm	500x400 x150	500x400 x150	500x400 x150	500x400 x150*	500x400 x150*	500x400 x150*	500x400 x150*	500x400 x150*	500x400 x150*
Net weight	kg	11,5	11,5	11,5	11,5*	11,5*	11,5*	11,5*	11,5*	11,5*
Pipe length range	m	10~100	10~100	10~100	10~100	10~100	10~100	10~100	10~100	10~100
Elevation difference (in / out)	Max m	10	10	10	10	10	10	10	10	10
Piping diameter	Liquid Inch (mm)	3/8(9,52)	3/8(9,52)	5/8(15,88)	3/4(19,05)	3/4(19,05)	3/4(19,05)	3/4(19,05)	7/8(22,22)	7/8(22,22)
	Gas Inch (mm)	5/8(15,88)	7/8(22,22)	1 1/8(28,58)	1 1/4(31,75)	1 1/2(38,15)	1 1/2(38,15)	1 1/2(38,15)	1 5/8(41,28)	1 3/4(44,45)
Intake temperature of AHU connection kit	Cool Min ~ Max °C DB	+18 ~ +32	+18 ~ +32	+18 ~ +32	+18 ~ +32	+18 ~ +32	+18 ~ +32	+18 ~ +32	+18 ~ +32	+18 ~ +32
	Cool Min ~ Max °C WB	+13 ~ +23	+13 ~ +23	+13 ~ +23	+13 ~ +23	+13 ~ +23	+13 ~ +23	+13 ~ +23	+13 ~ +23	+13 ~ +23
	Heat Min ~ Max °C	+16 ~ +30	+16 ~ +30	+16 ~ +30	+16 ~ +30	+16 ~ +30	+16 ~ +30	+16 ~ +30	+16 ~ +30	+16 ~ +30
Ambient temperature of outdoor unit	Cool Min ~ Max °C	-10 ~ +43	-10 ~ +43	-10 ~ +43	-10 ~ +43	-10 ~ +43	-10 ~ +43	-10 ~ +43	-10 ~ +43	-10 ~ +43
	Heat Min ~ Max °C	-20 ~ +15	-20 ~ +15	-20 ~ +15	-20 ~ +15	-20 ~ +15	-20 ~ +15	-20 ~ +15	-20 ~ +15	-20 ~ +15

\* The value applies to one unit of the AHU connection kit.

AHU connection kit / system combination			
Capacity	ECOi Series		AHU kit
5 HP 16 kW	Mini ECOi / ECOi EX ME2 Series		160MAH3M — —
10 HP 28 kW	U-8LZ2E8/U-10LZ2E8/ U-8LE1E8/U-10LE1E8/ U-10ME2E8	— —	280MAH3M — —
20 HP 56 kW	U-20ME2E8	— —	560MAH3M — —
30 HP 84 kW	U-16ME2E8	U-14ME2E8 —	560MAH3M 280MAH3M — —
40 HP 112 kW	U-20ME2E8	U-20ME2E8 —	560MAH3M 560MAH3M — —
50 HP 140 kW	U-18ME2E8	U-16ME2E8 U-16ME2E8	560MAH3M 560MAH3M 280MAH3M —
60 HP 168 kW	U-20ME2E8	U-20ME2E8 U-20ME2E8	560MAH3M 560MAH3M 560MAH3M —
70 HP 196 kW	U-20ME2E8	U-20ME2E8 U-20ME2E8	560MAH3M 560MAH3M 560MAH3M 280MAH3M
80 HP 224 kW	U-20ME2E8	U-20ME2E8 U-20ME2E8	560MAH3M 560MAH3M 560MAH3M 560MAH3M

Technical focus

- Maximum capacity / system: 80 HP (224 kW)
- Maximum piping length: 100 m (120 m equivalent)
- Elevation difference (indoor unit / indoor unit): 4 m
- In / out capacity ratio: 50~100%
- Maximum number of AHU connection kits: 4 units\*
- Outdoor temperature range in heating: -20 ~ +15 °C
- Available temperature range for the suction air at AHU connection kit: cool: +18 ~ +32 °C / heat: +16 ~ +30 °C
- The systems is controlled by the suction air (or room return air) temperature (same as standard indoor unit)
- The discharge air temperature is also controlled to prevent too-low air discharge in cooling or too-high air discharge in heating (in case of VRF)
- Demand control (forcible thermostat-OFF control by operating current)
- Defrost operation signal, Thermo-ON / OFF states output
- Drain pump control (drain pump and the float switch to be supplied in local)
- External target temperature setting via indoor / outdoor signal interface is available with CZ-CAPBC2 (Ex. 0-10 V)
- Demand control 40% to 120% (5% steps) by 0-10 V input signal
- Connectable with S-Link system. Special care for electrical noise may be necessary depending on the on-site system

- Fan control signal from the PCB can be used to control the air flow (high / mid / low and LL for Th-OFF). Need to change the fan control circuit wiring at field

\* To be simultaneous operation controlled by one remote controller sensor.

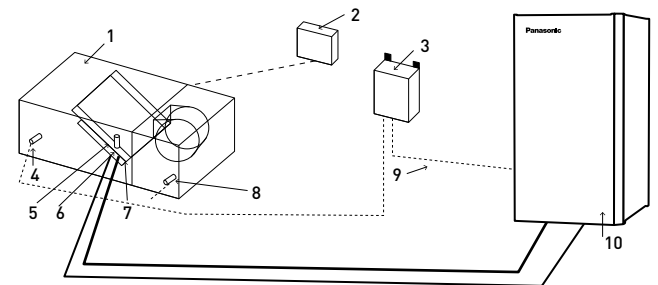

System and regulations. System overview.

- 1 | AHU Unit equipment (field supplied)
- 2 | AHU Unit system controller (field supplied)
- 3 | AHU connection kit controller box (with control PCB)
- 4 | Thermistor for discharge air
- 5 | Electronic expansion valve
- 6 | Thermistor for gas pipe [E3]
- 7 | Thermistor for liquid pipe [E1]
- 8 | Thermistor for suction air
- 9 | Inter-unit wiring
- 10 | ECOi or ECOi G outdoor unit

Optional controller.

Timer remote controller. CZ-RTC5B.



# Advanced energy recovery ventilation - ZY Series



Indoor air quality (IAQ) is a key consideration for any business owner looking to create a healthy and comfortable environment. An energy recovery ventilator (ERV) provides balanced, energy-efficient ventilation by transferring heat and moisture between incoming fresh filtered air and outgoing stale air. In the winter, an ERV keeps heat and moisture inside the building. During hot, humid summer months, it maintains cool, dry indoor air.



## Recovers up to 83% of the heat in the outgoing air

ZY Series achieves more than 80% of heat exchange efficiency in all the line-up <sup>1)</sup>. The high recovery rate optimizes operation cost and can be considered as a sustainable solution.

1) Heating operation, H1 speed setting.

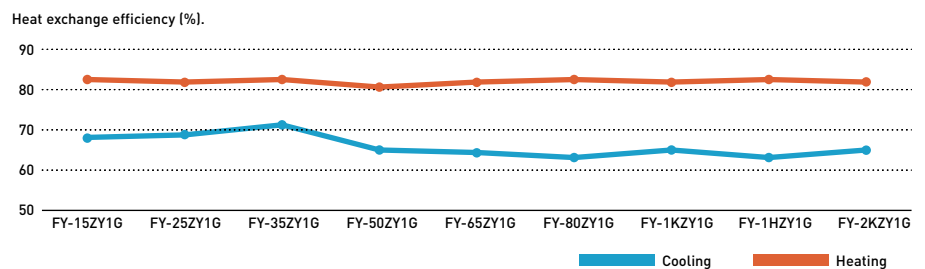

## Ventilation volume setting PQ curve example.

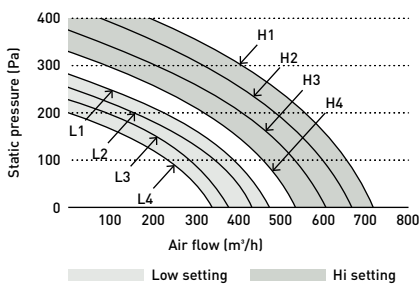

## Easy adjust for air volume balance

DC motors are equipped with independent control settings for air supply and exhaust. Air volume balance can be easily adjusted with 4 speeds settings for each Hi / Low operation.

## Intuitive remote controller with RS485 connection

- Simple and clean screen with white back light panel
- RS485 terminal equipped to integrate with Building Management Systems
- Metal switch box is included in the package



**Advanced energy recovery ventilation - ZY Series**

- Extended 9 model line-up including 2000 m³/h model
- DC motors
- ESP up to 150 Pa
- F7 grade filter built-in as a standard
- Intuitive remote controller
- BMS integration with RS485



Rated flow rate			150 m³/h	250 m³/h	350 m³/h	500 m³/h	650 m³/h	800 m³/h	1000 m³/h	1500 m³/h	2000 m³/h
<b>Indoor unit</b>			<b>FV-15ZY1G</b>	<b>FV-25ZY1G</b>	<b>FV-35ZY1G</b>	<b>FV-50ZY1G</b>	<b>FV-65ZY1G</b>	<b>FV-80ZY1G</b>	<b>FV-1KZY1G</b>	<b>FV-1HZY1G</b>	<b>FV-2KZY1G</b>
Power supply	Voltage	V	220 - 240	220 - 240	220 - 240	220 - 240	220 - 240	220 - 240	220 - 240	220 - 240	220 - 240
	Phase		Single phase	Single phase	Single phase	Single phase	Single phase	Single phase	Single phase	Single phase	Single phase
	Frequency	Hz	50	50	50	50	50	50	50	50	50
Motor type			DC	DC	DC	DC	DC	DC	DC	DC	DC
<b>ERV</b>											
Air flow	Max	m³/h	150	250	350	500	650	800	1000	1500	2000
External static pressure	Max	Pa	100	120	140	130	150	150	150	130	130
Sound power <sup>2)</sup>	Max	dB(A)	37	38	39	43	45	45	46	49	51
Input power	Max	W	76 - 84	106 - 117	141 - 155,5	180 - 198	420 - 462	470 - 517	550 - 605	940 - 1034	1100 - 1210
<b>Heat exchange efficiency <sup>3)</sup></b>											
Cooling	Max	%	68,0	69,0	71,0	65,0	64,0	63,0	65,0	63,0	65,0
Heating	Max	%	83,0	82,0	83,0	81,0	82,0	83,0	82,0	83,0	82,0
<b>Enthalpy exchange efficiency</b>											
Cooling	Max	%	66,0	66,0	67,0	62,5	62,5	63,5	63,0	63,5	63,0
Heating	Max	%	76,0	74,0	75,0	73,0	72,0	73,0	74,0	73,0	74,0
Adapter diameter		mm	100	150	150	200	200	250	250	250	250
Dimension	H x W x D	mm	289 x 610 x 860	289 x 735 x 860	331 x 874 x 968	331 x 1016 x 968	404 x 954 x 1008	404 x 1004 x 1224	404 x 1231 x 1224	808 x 1004 x 1224	808 x 1231 x 1224
Net weight		kg	23	27	37	40	48	60	64	119	142

1) Different dimensions depending on models. 2) Measurement of noise 1,5 m below the center of the main unit (anechoic chamber). 3) Heat exchange efficiency measurement standard JIS B 8628 (2003). \* JIS B 8628 (2017) is used in the measurement environment. \* A remote controller is included.

**Accessories**

<b>FV-FP15ZY1G</b>	Replacement high efficiency filter for FV-15ZY1G
<b>FV-FP25ZY1G</b>	Replacement high efficiency filter for FV-25ZY1G
<b>FV-FP35ZY1G</b>	Replacement high efficiency filter for FV-35ZY1G
<b>FV-FP50ZY1G</b>	Replacement high efficiency filter for FV-50ZY1G

**Accessories**

<b>FV-FP65ZY1G</b>	Replacement high efficiency filter for FV-65ZY1G
<b>FV-FP80ZY1G</b>	Replacement high efficiency filter for FV-80ZY1G and FV-1HZY1G <sup>1)</sup>
<b>FV-FP1KZY1G</b>	Replacement high efficiency filter for FV-1KZY1G and FV-2KZY1G <sup>1)</sup>
<b>PAW-ERV-IAQCT</b>	IAQ Controller

1) 2 sets of filters required for those models.

**Highly efficient filter for better air supply**

An effective EN F7 grade filter is built-in as a standard. Expected cleaning maintenance cycle is once per month, with an average of 4-6 months for replacement in high demand environments.

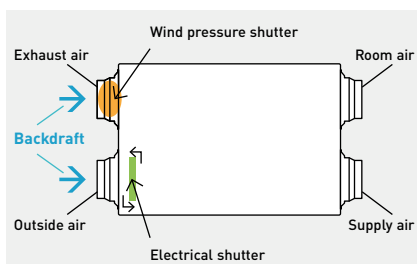

**Backdraft shutters equipped as standard**

A backdraft shutter prevents air flowing in the wrong direction when the ERV system is not in operation. The shutter at OA (outside air intake) side is inter-locked with ON / OFF switch. The shutter at EA (exhaust air outlet) side opens with the pressure generated by air stream then closes automatically.

**ERV IAQ Controller.**

**NEW PAW-ERV-IAQCT**

The IAQ Controller optimizes indoor air quality while reducing energy consumption. It also provides seamless control of auxiliary heaters, ensuring a comfortable and efficient environment. It is compatible with the ERV - ZY Series.

- **DCV (Demand-Controlled Ventilation):** Adjusts ERV airflow based on room or return air CO<sub>2</sub> levels, ensuring the right amount of fresh air
- **ERV Auto mode:** Automatically switches between heat recovery and bypass modes based on outdoor and indoor temperatures
- **Free Cooling:** Reduces AC cooling loads by using cool outdoor air, including night cooling based on a set schedule.

Dimension (HxWxD): 350 x 160 x 135 mm. Weight: 2,75 kg.



Internal image with the front cover removed.

# Energy recovery ventilation with DX coil - HRPT Series for VRF

The HRPT Series is specifically designed for commercial applications or collective residential buildings, offering highly efficient heat recovery of up to 85,2%. It's an ideal solution to achieve the highest energy certification for buildings in the tertiary, industrial and collective residential sectors including centralized condominium systems.



## Highly efficient and flexible

The HRPT Series is a dual flow ventilation with an EC fan, ensuring high efficiency heat recovery (>85%  $\eta$ ). The series includes five models with air flow rates from 480 to 1750 m<sup>3</sup>/h. Two types of polystyrene heat exchangers (high efficiency and sensible) are provided to meet a range of requirements.

## HRPT Series line-up

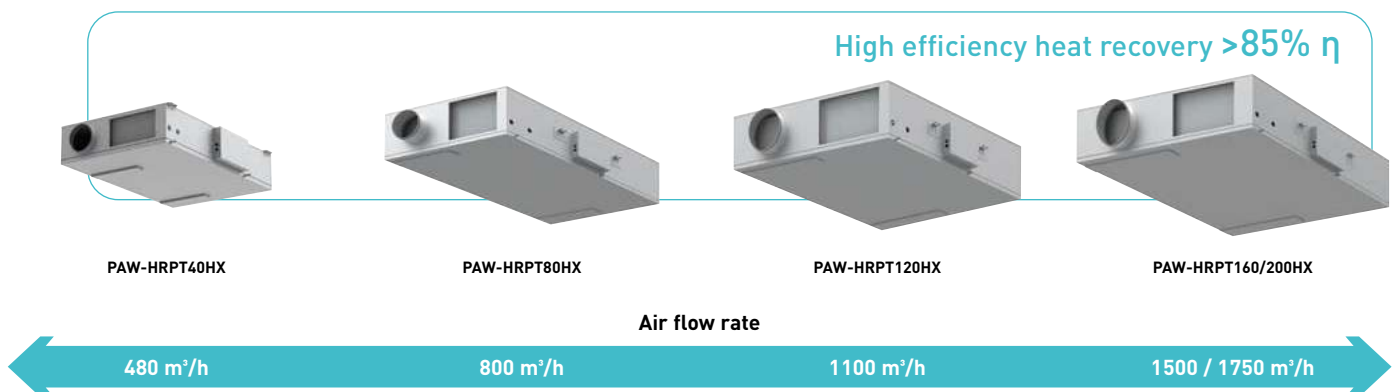

## Quality meets efficiency. Explore the HRPT Series

Reverse blade radial fans with low-consumption and low-noise electronic motor

Highly efficient polystyrene heat exchanger with counter-current flows and integrated bypass as standard

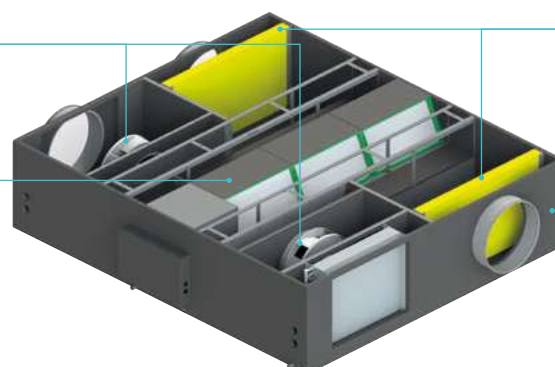

Two filters with low pressure drop: F7 (ePM1) on the fresh air and M5 (ePM10) on the ambient air

Structure with high thermal insulation

\* Model shown: HRPT120.



**Energy recovery ventilation with DX coil - HRPT Series - R32 / R410A**

- Dual flow ventilation with EC fan, featuring high efficiency heat recovery (>85% η)
- 2 types of polystyrene heat exchanger (high efficiency and sensible) with counter-current flows and integrated bypass as standard
- Modbus connection available



+ COMPATIBLE WITH ALL PANASONIC CONNECTIVITY SOLUTIONS. FOR DETAILED INFORMATION GO TO THE CONTROL SYSTEMS SECTION

Indoor unit with high efficiency heat exchanger			PAW-HRPT40HX	PAW-HRPT80HX	PAW-HRPT120HX	PAW-HRPT160HX	PAW-HRPT200HX					
Power supply	Voltage	V	230	230	230	230	380					
	Phase		Single phase	Single phase	Single phase	Single phase	Three phase					
	Frequency	Hz	50	50	50	50	50					
Heat recovery ventilation <sup>1)</sup>			Cooling	Heating	Cooling	Heating	Cooling	Heating	Cooling	Heating		
Temperature efficiency	%		63,4	76,7	60,0	73,5	61,4	75,0	62,2	76,0	59,4	73,2
Enthalpy efficiency	%		52,3	53,2	47,8	49,2	49,5	50,7	50,0	51,2	46,8	48,3
Weight	kg		70		120		135		150		180	

Indoor unit with sensible heat exchanger			PAW-HRPT40	PAW-HRPT80	PAW-HRPT120	PAW-HRPT160	PAW-HRPT200					
Power supply	Voltage	V	230	230	230	230	380					
	Phase		Single phase	Single phase	Single phase	Single phase	Three phase					
	Frequency	Hz	50	50	50	50	50					
Heat recovery ventilation <sup>1)</sup>			Cooling	Heating	Cooling	Heating	Cooling	Heating	Cooling	Heating		
Temperature efficiency	%		84,6	84,9	84,3	84,7	84,8	85,2	84,7	85,1	83,8	84,2
Weight	kg		67		117		132		147		177	

Common data			DX coil <sup>2)</sup>		Cooling	Heating	Cooling	Heating	Cooling	Heating	Cooling	Heating
Total / Sensible capacity	kW		3,0 / 2,4	3,2	6,0 / 4,1	6,2	8,0 / 5,5	8,3	10,0 / 7,1	11,0	12,5 / 8,6	12,8
Maximum input current	A		1,5		2,2		4,1		4,4		3,3	
Sound pressure @1 m / @3 m	dB(A)		41 / 35		51 / 43		42 / 36		49 / 41		57 / 49	
Air flow	High	m <sup>3</sup> /h	480		800		1100		1500		1750	
External static pressure	High	Pa	150		150		150		150		150	
Dimension	H x W x D	mm	283 x 975 x 1400		408 x 1180 x 1720		408 x 1580 x 1720		408 x 1980 x 1720		408 x 1980 x 1720	
Piping diameter	Liquid	Inch (mm)	1/4 (6,35)		3/8 (9,52)		3/8 (9,52)		3/8 (9,52)		3/8 (9,52)	
	Gas	Inch (mm)	1/2 (12,70)		5/8 (15,88)		5/8 (15,88)		5/8 (15,88)		5/8 (15,88)	

1) Data refers to the following conditions (UNI EN 13141-7): nominal air flow, external air 5 °C with 72% r. / expelled air 25 °C with 28% r. 2) Data refers to the following conditions: nominal air flow, cooling inlet coil summer 27 °C with 48% / heating inlet coil winter 20 °C with 50% r. \* Image is for PAW-HRPT40.

Accessories	
<b>CZ-RTC6W</b>	CONEX wired remote controller (non-wireless), white
<b>CZ-RTC6WBL</b>	CONEX wired remote controller with Bluetooth®, white
<b>CZ-RTC6</b>	CONEX wired remote controller (non-wireless), black
<b>CZ-RTC6BL</b>	CONEX wired remote controller with Bluetooth®, black
<b>CZ-RTC5B</b>	Wired remote controller with Econavi function

Accessories	
<b>CZ-RWS3 + CZ-RWRC3</b>	Infrared remote controller and receiver
<b>PAW-RE2C4-MOD-WH</b>	Room controller for hotel rooms, white
<b>PAW-RE2C4-MOD-BK</b>	Room controller for hotel rooms, black
<b>PAW-RE2D4-WH</b>	Display control for hotel rooms, white
<b>PAW-RE2D4-BK</b>	Display control for hotel rooms, black

**Technical focus**

- Dual flow ventilation with EC fan, featuring high efficiency heat recovery (>85% η)
- 5 model line-up is available with air flow rates of 480, 800, 1100, 1500 and 1750 m<sup>3</sup>/h
- 2 types of polystyrene heat exchanger (high efficiency and sensible) with counter-current flows and integrated bypass as standard
- Automatic defrosting of the exchanger
- Low consumption and EC motors with electronic speed control ensure high useful static pressure for circular inlet connection to air ducts
- Wide ambient temperature range up to +50 °C and down to -15 °C
- Modbus connection available

**Interconnection to outdoor / indoor units**

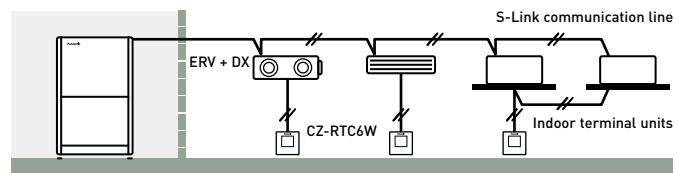

**Aeraulic performance**

EC motors with electronic speed control ensure high values of effective static pressure for ducting.

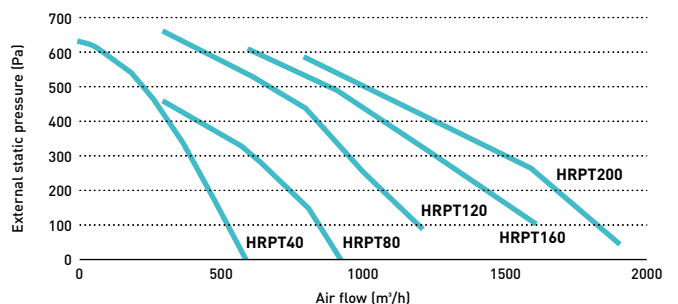

## Electric air curtains

The Panasonic range of air curtains is designed for smooth operation and efficient performance. Air curtains produce a continuous stream of air blown from the top to the bottom of an open doorway and create a barrier that people and products can flow across, but air cannot.



### Electric air curtain

**1 Designed to maximize performance**  
High air flow upgraded 145% compared to conventional model (in the case of FY-3009U1).

**2 Comprehensive product line up**  
1,5 m wide model added in the line up.

**3 Easier installation and maintenance**  
Simple structure for easy installation and maintenance.



			FY-3009U1	FY-3012U1	FY-3015U1
Width		mm	900	1200	1500
Voltage		V	220	220	220
Air flow	Hi / Lo	m <sup>3</sup> /h	1100/920	1400/1270	2000/1800
Consumption	Hi / Lo	W	76/70	94/85	131/110
Current	Hi / Lo	A	0,35/0,32	0,43/0,40	0,59/0,50
Air speed	Hi / Lo	m/s	10,50/8,50	9,50/8,00	10,50/9,50
Sound pressure	Hi / Lo	dB(A)	48,5/45,0	48,5/44,5	51,5/48,0
Dimension	HxWxD	mm	900x231,5x212	1200x231,5x212	1500x231,5x212
Net weight		kg	12,0	14,5	18,0

## Electric air curtain with DX coil

Designed to improve energy efficiency, minimise heat loss from a building, and allow retailers to keep doors open to encourage customers, our air curtains are suitable for connection to both PACi NX and VRF Systems.



### Highly efficient heating effect

The combined air stream, which has a desirable low air current induction factor (mixing factor), can carry the selected initial temperature effect over long distances, and will reach the floor area while still at room temperature. This is necessary to avoid cooling down the interior spaces.

Available in different lengths to suit requirements between 1 and 2,5 m, both air curtains have outlet grilles that can be adjusted to five different positions. The HS model can be installed up to a height of 3,0 m with the LS model up to 2,7 m. The outlet grilles can be easily adjusted into five positions to suit different installation requirements and the air filter can be accessed without the need for specialist tools.

- High performance with EC fan motor (40% lower running costs compared to a standard AC fan motor)
- Easy Cleaning and Servicing
- Can be connected to either Panasonic VRF or PACi NX systems
- Drain pump for cooling operation optional
- HS and LS models can be controlled via Panasonic's range of remote internet controls

### Heating capacity comparison: Electrical air curtain / Panasonic air curtain.

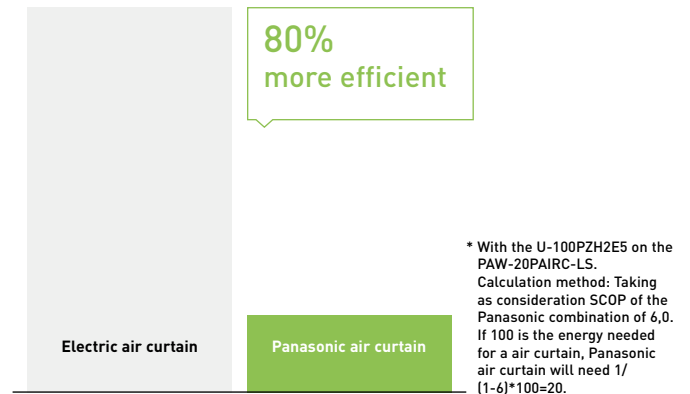

The HS and LS models are ideal for connection to a ECOi or PACi NX system. With simple "Plug & Play" installation, both are fitted with an EC fan motor for a smooth operation and efficient performance. This fan guarantees 40% lower running cost than with a standard AC fan motor. Air curtains run approximately 12 hours per day at shops, and efficient performance contributes to energy savings.

### Optimised air flow velocity

- 1 | Energy losses, no air curtain installed
- 2 | Too low velocity air curtain – air curtain not efficient

- 3 | Too high velocity air curtain – considerable turbulence, energy lost to the outside, air curtain not efficient
- 4 | Optimum results with the Frico air curtain connected to Panasonic VRF

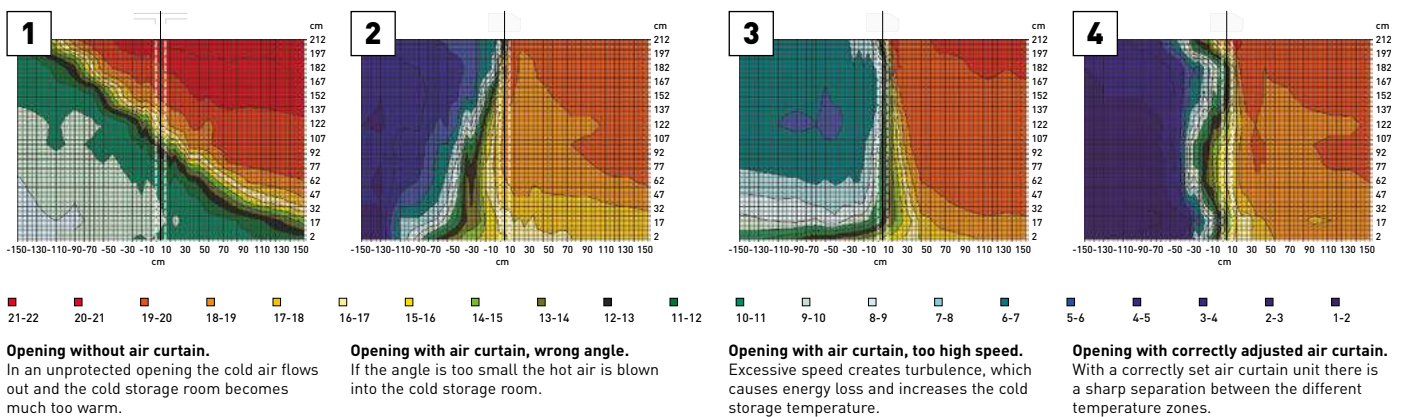

### Intelligent operation

Our air curtains combine air flow and heating / cooling technology to ensure optimum comfort and energy efficiency whilst also creating an effective barrier between indoor and outdoor environments. Design and installation is key to achieving the correct height / temperature settings to achieve optimum performance. Our air curtains are designed to answer the demands of the retail, commercial and industrial markets.

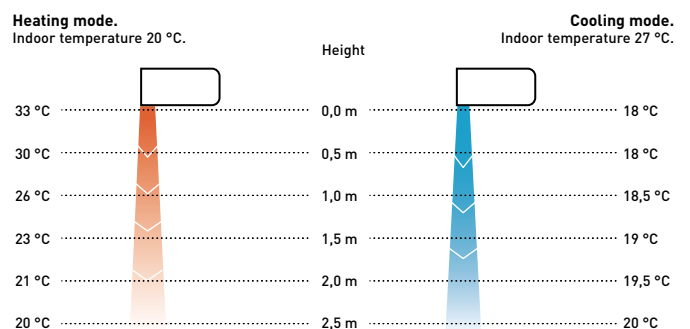

## Air curtain with DX coil, connected to PACi NX

**Comfort:** Easy redirection of air flow by means of manual deflector.

**Ease of use:** Speed selector (high and low) on the unit itself.

**Easy installation and maintenance:** Easy installation / Compact dimensions improve installation and positioning / Easy cleaning of grid without opening of the unit.



Outdoor unit capacity			7,1 kW	10,0 kW	14,0 kW	20,0 kW
Air outlet height 2,7 m			PAW-10PAIRC-LS-1	PAW-15PAIRC-LS-1	PAW-20PAIRC-LS-1	PAW-25PAIRC-LS-1
Cooling capacity <sup>1)</sup>	Max	kW	6,1	9,7	13,0	17,0
Heating capacity <sup>2)</sup>	Max	kW	7,9	12,0	15,0	19,0
Air flow	High	m <sup>3</sup> /h	1800	2700	3600	4500
Heat Exchanger	Volume	L	1,67	2,85	3,94	5,03
Electric consumption fan	230 V / 50 Hz	kW	0,30	0,50	0,60	0,80
Current	230 V / 50 Hz	A	2,10	3,10	4,10	5,10
Sound pressure <sup>3)</sup>	Max	dB(A)	65	66	67	69
Air outlet height 3,0 m			PAW-10PAIRC-HS-1	PAW-15PAIRC-HS-1	PAW-20PAIRC-HS-1	PAW-25PAIRC-HS-1
Cooling capacity <sup>1)</sup>	Max	kW	9,1	13,0	19,5	23,7
Heating capacity <sup>2)</sup>	Max	kW	11,8	15,8	23,6	27,6
Air flow	High	m <sup>3</sup> /h	2700	3600	5400	6300
Heat Exchanger	Volume	L	1,67	2,85	3,94	5,12
Electric consumption fan	230 V / 50 Hz	kW	0,75	1,00	1,50	1,75
Current	230 V / 50 Hz	A	4,10	5,50	8,20	9,60
Sound pressure <sup>3)</sup>	Max	dB(A)	66	67	68	68
Common data						
Dimension <sup>4)</sup>	HxWxD	mm	260 (+140) x 1000 x 460	260 (+140) x 1500 x 460	260 (+140) x 2000 x 460	260 (+140) x 2500 x 460
Net weight	Air outlet height 2,7 m	kg	50	65	80	95
	Air outlet height 3,0 m	kg	55	65	85	110
Fan type			EC	EC	EC	EC
Piping diameter	Liquid / Gas	Inch (mm)	3/8 (9,52) / 5/8 (15,88)	3/8 (9,52) / 3/4 (19,05)	3/8 (9,52) / 7/8 (22,22)	3/8 (9,52) / 7/8 (22,22)
Door width		m	1,0	1,5	2,0	2,5
Refrigerant			R32	R32	R32	R32

LS / PACi NX outdoor combination*	PACi NX Elite			PACi NX Standard		
	40 °C	35 °C	30 °C	40 °C	35 °C	30 °C
PAW-10PAIRC-LS-1	U-100	U-100	U-50	U-100	U-100	U-60
PAW-15PAIRC-LS-1	U-200	U-100	U-100	—	U-100	U-100
PAW-20PAIRC-LS-1	U-200	U-140	U-100	—	—	U-100
PAW-25PAIRC-LS-1	U-250	U-200	U-125	—	—	U-125

HS / PACi NX outdoor combination*	PACi NX Elite			PACi NX Standard		
	40 °C	35 °C	30 °C	40 °C	35 °C	30 °C
PAW-10PAIRC-HS-1	U-200	U-100	U-100	—	U-100	U-100
PAW-15PAIRC-HS-1	U-200	U-200	U-100	—	U-200	U-100
PAW-20PAIRC-HS-1	—	U-250	U-200	—	U-250	—
PAW-25PAIRC-HS-1	—	U-250	U-200	—	U-250	—

1) Cooling capacity DX coil, air temperature in / out +27 / +18 °C, R32 and R410. 2) Heating capacity condenser, air temperature in / out +20 / +33 °C, R32 and R410. In the case of lower outdoor temperatures, an outdoor model with higher capacity may be necessary. 3) Measured in distance up to 5,0 m, direction factor 2, absorbing surfaces 200 m<sup>2</sup>, Min / Max air flow. 4) 140 mm is the height of an electrical box if it is installed on the top.

### Technical focus

- Save up to 40% energy costs by use of the integrated EC fan technology (higher efficiency than conventional AC fan, soft start and longer motor duration)
- 4 length of air curtain LS and HS are available 1,0, 1,5, 2,0 and 2,5 m
- Installation height up to 3,0 m
- Outlet grilles can be adjusted in five positions, to suite different indoor and installation requirements
- Control with Panasonic remote control systems (optional)
- Direct integration to BMS via optional Panasonic interfaces
- Drip tray included in all DX air curtains
- Drain pump optional

### How does it work?

Stale air from the room is taken in and ejected near the door. This creates a 'roll of air' that shields the door area, mixing with the colder incoming air. It then turns away from the door, back into the room and toward the intake screen, where it is partly drawn in again. This flow of air helps to create a barrier for heat loss yet at the same time refreshes room air

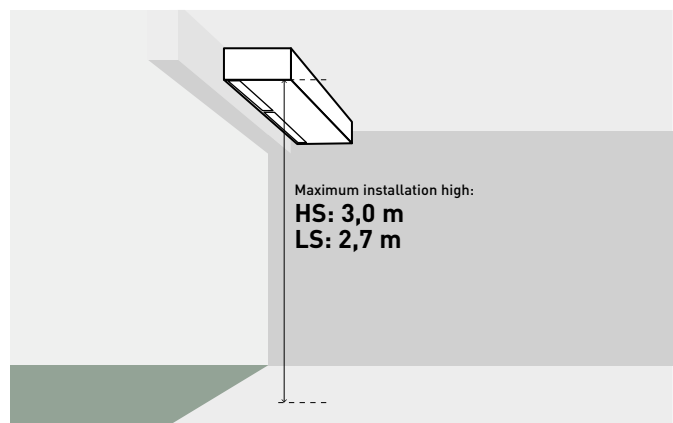

**Air curtain with DX coil, connected to VRF systems**

**Comfort:** Easy redirection of air flow by means of manual deflector.

**Ease of use:** Speed selector (high and low) on the unit itself.

**Easy installation and maintenance:** Easy installation / Compact dimensions improve installation and positioning / Easy cleaning of grid without opening of the unit.



Outdoor unit capacity			4 HP	4 HP	5 HP	8 HP
Air outlet height 2,7 m			PAW-10EAIRC-LS	PAW-15EAIRC-LS	PAW-20EAIRC-LS	PAW-25EAIRC-LS
Cooling capacity <sup>1)</sup>	Max	kW	6,1	9,7	13,0	17,0
Heating capacity <sup>2)</sup>	Max	kW	7,9	12,0	15,0	19,0
Air flow	High	m <sup>3</sup> /h	1800	2700	3600	4500
Heat Exchanger	Volume	L	1,67	2,85	3,94	5,03
Electric consumption fan	230 V / 50 Hz	kW	0,30	0,50	0,60	0,80
Current	230 V / 50 Hz	A	2,10	3,10	4,10	5,10
Sound pressure <sup>3)</sup>	Max	dB(A)	65	66	67	69
Air outlet height 3,0 m			PAW-10EAIRC-HS	PAW-15EAIRC-HS	PAW-20EAIRC-HS	PAW-25EAIRC-HS
Cooling capacity <sup>1)</sup>	Max	kW	9,1	13,0	19,5	23,7
Heating capacity <sup>2)</sup>	Max	kW	11,8	15,8	23,6	27,6
Air flow	High	m <sup>3</sup> /h	2700	3600	5400	6300
Heat Exchanger	Volume	L	1,67	2,85	3,94	5,12
Electric consumption fan	230 V / 50 Hz	kW	0,75	1,00	1,50	1,75
Current	230 V / 50 Hz	A	4,10	5,50	8,20	9,60
Sound pressure <sup>3)</sup>	Max	dB(A)	66	67	68	68
Common data						
Dimension <sup>4)</sup>	HxWxD	mm	260 (+140)x1000x460	260 (+140)x1500x460	260 (+140)x2000x460	260 (+140)x2500x460
Net weight	Air outlet height 2,7 m	kg	50	65	80	95
	Air outlet height 3,0 m	kg	55	65	85	110
Fan type			EC	EC	EC	EC
Piping diameter	Liquid / Gas	Inch (mm)	3/8(9,52) / 5/8(15,88)	3/8(9,52) / 3/4(19,05)	3/8(9,52) / 7/8(22,22)	3/8(9,52) / 7/8(22,22)
Door width		m	1,0	1,5	2,0	2,5
Refrigerant			R32 / R410A	R32 / R410A	R32 / R410A	R32 / R410A

LS / VRF outdoor combination			
Operation until	40 °C	35 °C	30 °C
PAW-1EAIRC-LS	U-4	U-4	U-4
PAW-15EAIRC-LS	U-6	U-5	U-4
PAW-20EAIRC-LS	U-8	U-6	U-4
PAW-25EAIRC-LS	U-8	U-8	U-5

HS / VRF outdoor combination			
Operation until	40 °C	35 °C	30 °C
PAW-10EAIRC-HS	U-6	U-5	U-4
PAW-15EAIRC-HS	U-8	U-6	U-4
PAW-20EAIRC-HS	U-8	U-8	U-8
PAW-25EAIRC-HS	U-12	U-10	U-8

1) Cooling capacity DX coil, air temperature in / out +27 / +18 °C, R32 and R410. 2) Heating capacity condenser, air temperature in / out +20 / +33 °C, R32 and R410. In the case of lower outdoor temperatures, an outdoor model with higher capacity may be necessary. 3) Measured in distance up to 5,0 m, direction factor 2, absorbing surfaces 200 m<sup>2</sup>, Min / Max air flow. 4) 140 mm is the height of an electrical box if it is installed on the top. \* Also compatible with ECO G Series (GE3 and GF3) and Hybrid Serie.

**Technical focus**

- Compatible with R32 and R410A refrigerant
- Save up to 40% energy costs by use of the integrated EC fan technology (higher efficiency than conventional AC fan, soft start and longer motor duration)
- 4 length of air curtain LS and HS are available 1,0, 1,5, 2,0 and 2,5 m
- Installation height up to 3,0 m
- Outlet grilles can be adjusted in five positions, to suite different indoor and installation requirements
- Control with Panasonic remote control systems (optional)
- Direct integration to BMS via optional Panasonic interfaces
- Drip tray included in all DX air curtains
- Drain pump optional

**Internet control**

An app added to your tablet or smartphone or via the Internet allows you to control and manage the system remotely. There is also the option to integrate into existing BMS systems by using other Panasonic interfaces.

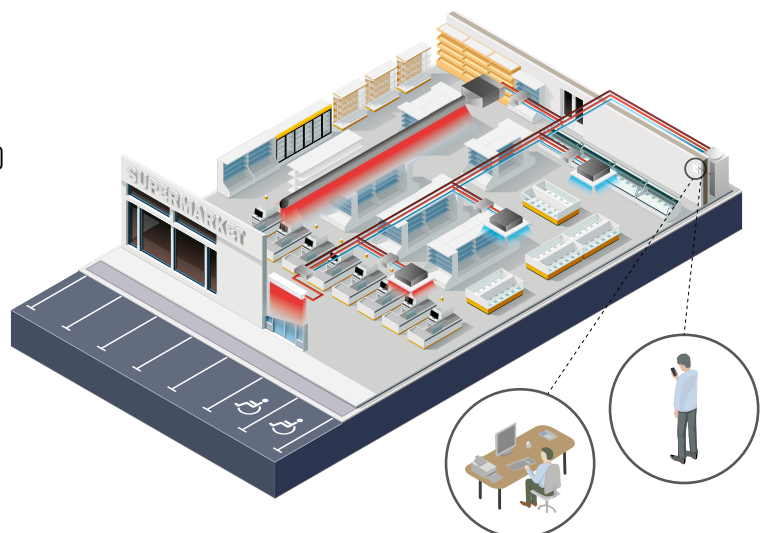

## High pressure duct and 100% fresh air duct function for all ECOi and ECO G systems

The E2 range of ducted units offers improved design flexibility for extended duct layouts as a result of their increased external static pressures whilst reducing energy consumption, while providing fresh air to larger spaces.



## E2 type high static pressure hide-away · R410A

### High pressure duct and 100% fresh air duct function.



+ COMPATIBLE WITH ALL PANASONIC CONNECTIVITY SOLUTIONS. FOR DETAILED INFORMATION GO TO THE CONTROL SYSTEMS SECTION

Type	100% fresh air duct function (by using kit for 100% fresh air)				High pressure duct					
	Indoor unit	S-224ME2E5		S-280ME2E5		S-224ME2E5		S-280ME2E5		
		Cooling	Heating	Cooling	Heating	Cooling	Heating	Cooling	Heating	
Capacity	kW	22,4	21,2	28,0	26,5	22,4	25,0	28,0	31,5	
Input power	W	290,00	290,00	350,00	350,00	440,00	440,00	715,00	715,00	
Current	A	1,85	1,85	2,20	2,20	2,45	2,45	3,95	3,95	
Air flow	Hi/Med/Lo	m <sup>3</sup> /min		35,0/-/-		56,0/51,0/44,0		72,0/63,0/53,0		
External static pressure	Pa	200		200		140(60-270) <sup>1)</sup>		140(72-270) <sup>1)</sup>		
Sound pressure <sup>2)</sup>	Hi/Med/Lo	dB(A)		43/-/-		44/-/-		49/47/43		
Sound power	Hi/Med/Lo	dB(A)		75/-/-		76/-/-		81/79/75		
Dimension	H x W x D	mm		479 x 1453 x 1205		479 x 1453 x 1205		479 x 1453 x 1205		
Net weight	kg	102		106		102		106		
Piping diameter	Liquid	Inch (mm)	3/8(9,52)		3/8(9,52)		3/8(9,52)		3/8(9,52)	
	Gas	Inch (mm)	3/4(19,05)		7/8(22,22)		3/4(19,05)		7/8(22,22)	

Rating conditions for 100% fresh air duct function: Cooling outdoor 33 °C DB / 28 °C WB. Heating outdoor 0 °C DB / -2,9 °C WB.  
 1) Available to select the setting by initial setup. 2) Values with 140 Pa setting. \* No filter included. \*\* No compatible with 3-Pipe ECO G 6F3.

Accessories	
<b>CZ-RTC6W</b>	CONEX wired remote controller (non-wireless), white
<b>CZ-RTC6WBL</b>	CONEX wired remote controller with Bluetooth®, white
<b>CZ-RTC6</b>	CONEX wired remote controller (non-wireless), black
<b>CZ-RTC6BL</b>	CONEX wired remote controller with Bluetooth®, black
<b>CZ-RTC5B</b>	Wired remote controller with Econavi function
<b>CZ-RWS3 + CZ-RWRC3</b>	Infrared remote controller and receiver

Accessories	
<b>PAW-RE2C4-MOD-WH</b>	Room controller for hotel rooms, white
<b>PAW-RE2C4-MOD-BK</b>	Room controller for hotel rooms, black
<b>PAW-RE2D4-WH</b>	Display control for hotel rooms, white
<b>PAW-RE2D4-BK</b>	Display control for hotel rooms, black
<b>CZ-CENSC1</b>	Econavi energy saving sensor

### Technical focus

- No need of rap valves for standard operation
- 100% fresh air duct function\*
- DC fan motor for more savings
- Complete flexibility for ductwork design
- Can be located within a weatherproof housing for external installation
- Air OFF sensor avoids cold air dumping
- Configurable air temperature control

\* Rap valves required, see 100% fresh air duct function below.

### 100% fresh air duct function

The E2 duct with 100% fresh air duct function have exceptional discharge temperature.

	Discharge Range		
	Min	Max	Default
Cooling	15 °C	24 °C	18 °C
Heating	17 °C	45 °C	40 °C

### System example

An inspection port (450 x 450 mm or more) is required at the lower side of the indoor unit body (field supply).

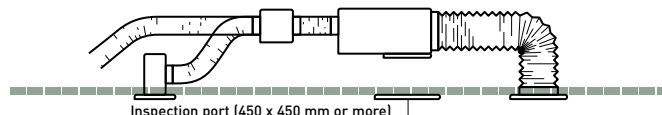

### Plenums

Air outlet plenum (suitable for rigid + flexible duct)	Number of exits with diameters	Model
S-224ME2E5	1 x 500 mm	CZ-TREMIESPW705
S-280ME2E5	1 x 500 mm	CZ-TREMIESPW706

### Kit for 100% fresh air function

Kit for 2 way systems		Kit for 3 way systems	
<b>2x CZ-P160RVK2</b>	Rap valve kit	<b>2x CZ-P160HR3</b>	3 way valve kit
<b>2x CZ-CAPE2</b>	3 way control PCB	<b>2x CZ-CAPE2</b>	3 way control PCB
<b>CZ-P680BK2BM</b>	Distribution joint kit	<b>CZ-P680BH2BM</b>	Distribution joint kit
	1x remote controller		1x remote controller



ECONAVI and INTERNET CONTROL: Optional.

# Ceiling mounted air-e nanoe X Generator

Bringing nature's balance indoors with Panasonic's unique nanoe™ X technology built into the air-e.

Deodorises and inhibits certain bacteria, viruses, mould, pollens and allergens for better indoor air quality.



The air-e is a stand alone device which is an easy and simple choice to improve indoor air quality. It can be easily installed to various commercial projects including refurbishments.

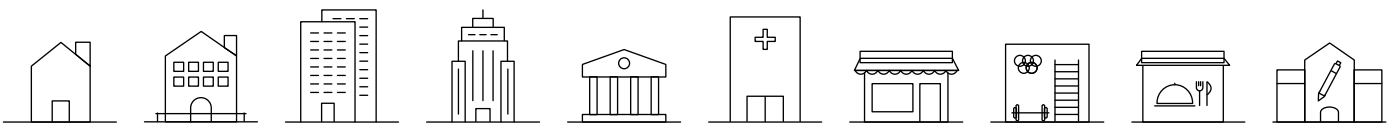

## The tested effects of nanoe™ X

### Bacteria and viruses.

SARS-CoV-2: 99,9% % inhibited <sup>1)</sup>

Influenza virus H1N1 subtype: 99,9 % inhibited <sup>2)</sup>

### Odour.

nanoe X Generator can reduce cigarette smoke odour intensity by 2,4 levels in 12 minutes.

1) Novel coronavirus [SARS-CoV-2] > [Test organization] Texcell (France) [Test subject] Adhered novel coronavirus [SARS-CoV-2] [Test volume] 45 L enclosed box [Test result] Inhibited 99,9% in 2 hours [Test report] 1140-01 A1.

2) Adhered virus (Influenza virus H1N1 subtype) > [Test organization] Kitasato Research Center for Environmental Science [Test subject] Influenza virus (H1N1 subtype) [Test volume] 1000 L enclosed box [Test result] Inhibited 99,9% in 2 hours [Test report] 21\_0084\_1.

3) Deodorisation effect for adhering odour (cigarette smoke) > [Test organization] Panasonic Product Analysis Center [Test subject] Adhered cigarette smoke odour [Test volume] Approx. 24 m<sup>3</sup> laboratory [Test result] Odour intensity reduced 2,4 levels in 0,2 hours [Test report] 4AA33-160615-N04.

Performance of nanoe™ X might differ in real life environment and is only expected in the same room as where the unit is placed. The nanoe™ X performance varies depending on the room size, environment and usage and it may take several hours to reach the full effect. nanoe™ X is not a medical device.

Deodorisation effect for adhering odour (cigarette smoke) <sup>3)</sup>.

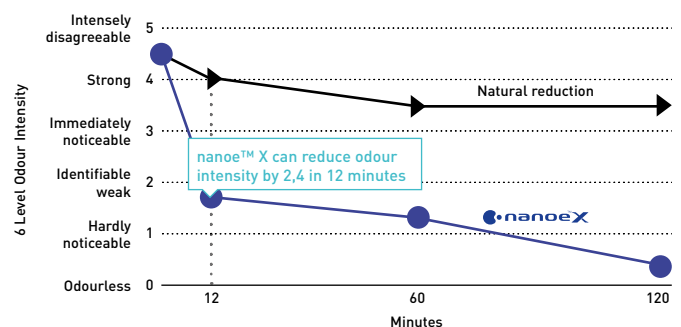

For further details and validation data, please refer to the following website.





### Ceiling mounted air-e nanoe X Generator

- nanoe™ X technology  
(Generator Mark 1: 4,8 trillion hydroxyl radicals/sec)
- Silent operation. Whisper quiet at 25,5 dB(A)\*
- Low power consumption 4 W
- Easy installation
- Compact and modern design

\* 230 V.

air-e™



Model	FV-15CSD1G					
Power supply	Voltage	V	220	230	240	
	Frequency	Hz	50	50	50	
Air flow	m³/h		15	16	17	
	CFM		8,8	9,4	10,0	
Consumption	W		4	4	4	
Sound pressure	dB(A)		23,5	25,5	27,0	
Net weight	kg			1,1		

\* The value of air volume, power consumption and noise are specified at static pressure 0 Pa. The value of air volume is the mean value and a tolerance of +-10% is allowed. The value of noise level is a weighted average sound pressure level, the mean value is measured by Panasonic. A tolerance of +3 dB/-7 dB is allowed. The noise is measure at 1 m apart from the left, the front and below of the tested product. Conditions of generating nanoe™ X: room temperature: about 5 °C ~ 40 °C (dew point temperature more than 2 °C), relative humidity: about 30% ~ 85%. nanoe™ X is generated using the air in the room, and its amount is subject to the temperature and humidity in the air.

### One device is suitable for around 20 m² (with a ceiling height 3 m)

Ex. 3 air-e devices are required for the room size 60 m².

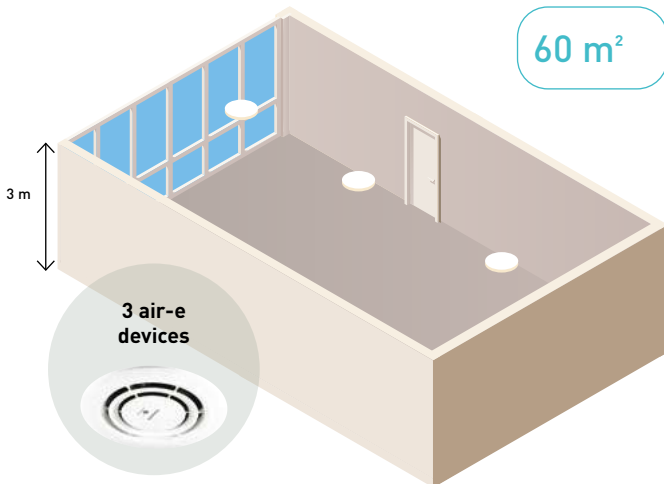

### Concentration simulator is ready

See how nanoe™ X fills space.

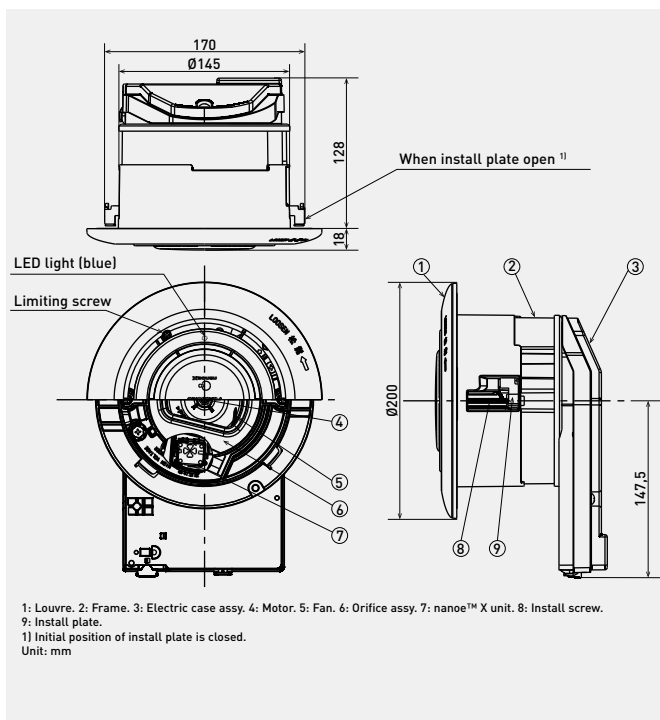
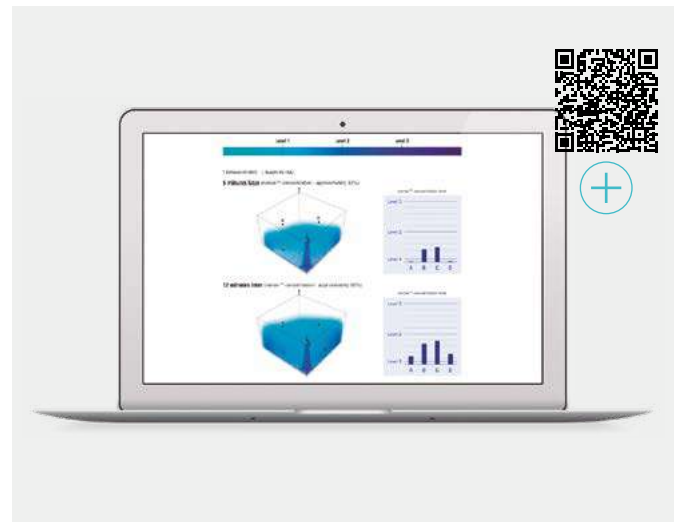

### Projects with nanoe™ X.



**Cabinet Dental. France.**  
The request by a customer to manage the indoor air quality in order to ensure irreproachable hygiene and odour control.



**Mercat d'autors shop. Spain.**  
The nanoe™ X was chosen to ensure a cleaner air supply at a food market.

# Heat recovery ventilation unit

The heat recovery ventilation unit is design not only to provide a good indoor air quality, but it is also designed to recover heat that would otherwise be lost throughout ventilation. These heat recovery ventilation systems are used to assist in the retention of heat.

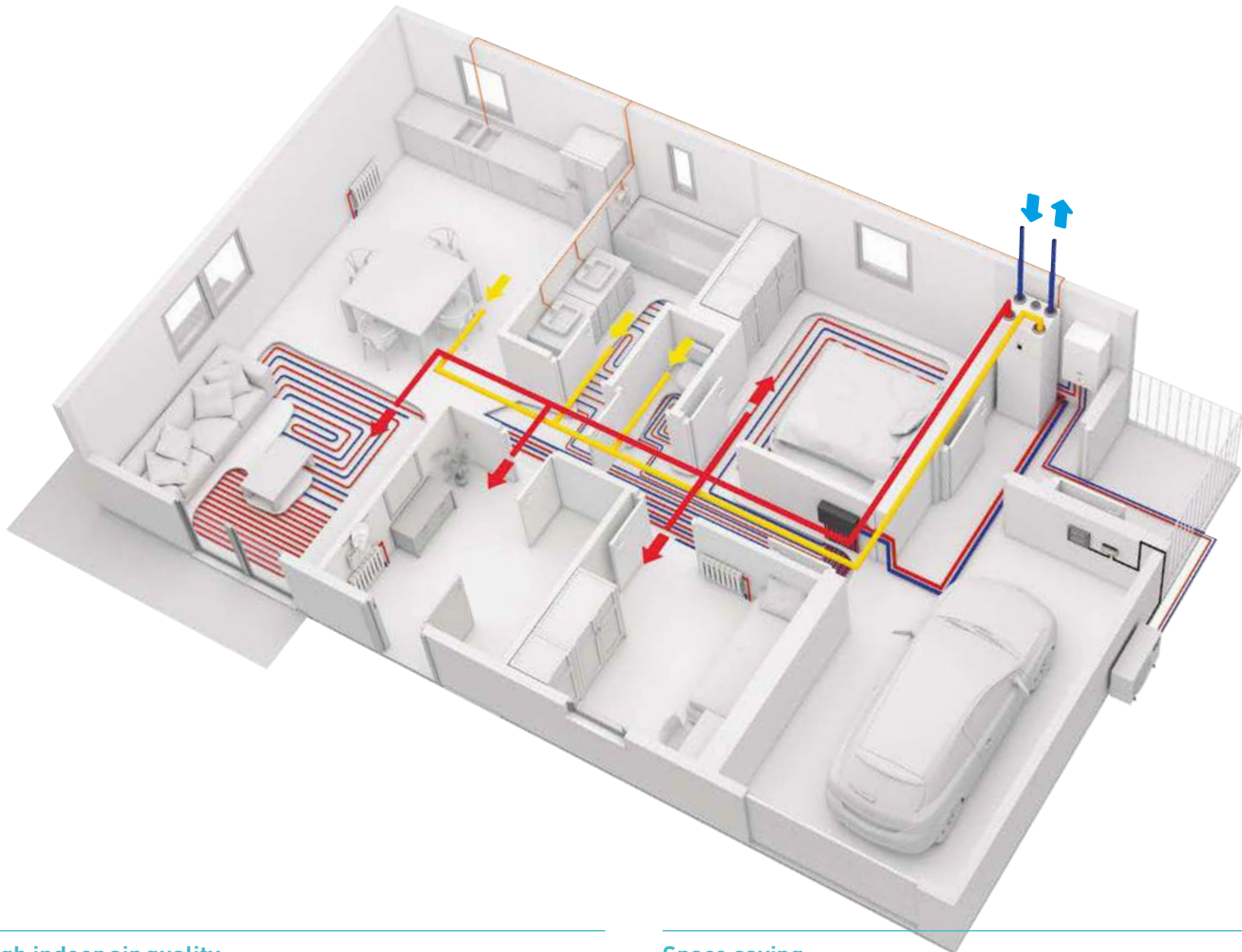

## High indoor air quality

The unit is designed to provide fresh filtered air into the home, while keeping a high thermal comfort.

## Energy saving

Most of the energy from the exhausted air is used to precondition the incoming air, leading to lower heating requirements in the building.

## Space saving

The compact ventilation unit can be installed over the DHW square tank or the Aquarea All in One Compact indoor unit for a space-saving solution.

## Better user interface

The Residential ventilation unit and the Aquarea Heat Pumps can be controlled with one single user-friendly controller.

## AQUAREA

Combine the Residential ventilation unit with Panasonic Aquarea for an space saving and highly efficient solution for heating, cooling, ventilation and DHW.



Heat Recovery Ventilation +  
Aquarea All in One Compact



Heat Recovery Ventilation +  
DHW Square Tank + Aquarea  
Mono-bloc



Heat Recovery Ventilation +  
DHW Square Tank + Aquarea  
Bi-bloc

\* The unit can be mounted on a PAW-TA20C1E5C, on a WH-ADC0309J3E5C or installed on the wall (PAW-VEN-WBRK is needed).

Heat recovery ventilation unit



Model		PAW-A2W-VENTA-R	PAW-A2W-VENTA-L
Nominal air flow rate	m <sup>3</sup> /h	204 @ 50 Pa	
Maximum air flow rate	m <sup>3</sup> /h	292 @ 100 Pa	
SPF		1,24 @ 204 m <sup>3</sup> /h	
Heat exchanger rotor drive type		Variable speed	
Exchanger type		Rotating	
Heat recovery efficiency		84%	
Power supply	V / Hz	230 / 50 / Single phase	
Power consumption	W	176	
<b>Energy class, basic unit</b>		<b>A</b>	
<b>Energy class, unit with local control on demand</b>		<b>A</b>	
Noise level	dB(A)	40	
Dimension (H x W x D)	mm	450 x 598 x 500	
Weight	kg	46	
Mounting position		Vertical	
Supply side		Right	Left
Duct connections	mm	DN125	
Filter class, supply air		F7/ePM1 60%	
Filter class, extract air		M5/ePM10 50%	
Minimum outdoor temperature	°C	-20	

\* Heat recovery efficiency according to EN 13141-7. \*\* Heat recovery ventilation unit is produced by Systemair.

Accessories	
<b>PAW-VEN-FLTKIT</b>	Supply and extract filters kit
<b>PAW-VEN-ACCPCB</b>	Optional PCB for additional functions
<b>PAW-VEN-DPL</b>	HRV touch control panel. White frame (cable must be ordered separately)
<b>PAW-VEN-CBLEXT12</b>	Cable with plug for electrical connection between unit and control panel, type CE and CD (12 m)
<b>PAW-VEN-DIVPLG</b>	Twin plugs for installation of several control panels type CD ou CE for one unit

Accessories	
<b>PAW-VEN-DPLBOX</b>	HRV touch control panel wall-mounted kit
<b>PAW-VEN-S-CO2RH-W</b>	CO <sub>2</sub> RH wall-mounted sensor
<b>PAW-VEN-S-CO2-W</b>	CO <sub>2</sub> wall-mounted sensor
<b>PAW-VEN-S-CO2-D</b>	CO <sub>2</sub> duct sensor
<b>PAW-VEN-WBRK</b>	Wall bracket kit for stand-alone installation on the wall
<b>PAW-VEN-HTR06</b>	Electrical duct heater 0,6 kW (includes relay)
<b>PAW-VEN-HTR12</b>	Electrical duct heater 1,2 kW (includes relay)

Main features of the residential ventilation unit

- Designed for areas up to approximately 140 m<sup>2</sup>
- High energy-efficiency rotary heat exchanger with EC - technology fans
- Moisture transfer function to minimize condensation in supply air during wintertime
- The built in humidity sensor in extract air can be used for demand control
- Control via touch display and Startup Wizard for easy commissioning
- Modbus communication via RS-485
- Option to control an Aquarea H Series onwards heat pump from PAW-A2W-VENTA control panel (PAW-AW-MBS-H and PAW-VEN-ACCPCB required)

Control user-friendly interface

All settings and features accessible via a control panel, integrated into the front cover. The option for connecting one or more external control panels is available.

- Color touch screen with a user-friendly interface
- MANUAL and AUTO mode or choose preferred settings from the pre-configured user modes
- If Aquarea H and J Series heat pumps are connected with PAW-A2W-VENTA, the heat pump control options appear on the home screen in a separate tab

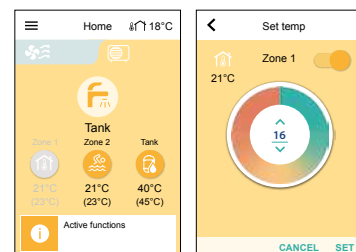
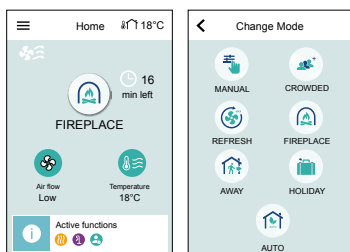

## Aquarea Vent - Counter flow ventilation

Aquarea Vent systems provide a continuous supply of fresh air, ensuring optimal indoor air quality and comfort. Ideal for single-family homes or apartments with low energy requirements, Panasonic's HRV systems combine high-efficiency heat recovery, quiet operation, and advanced air filtration with flexible installation options.



High-efficiency sensible heat recovery.

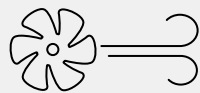

Highly efficient air renewal and filtration, with 80% ePM1 filters.



Integrated air quality, humidity and temperature sensors.



Remote control via Wi-Fi (optional).

### Balanced ventilation

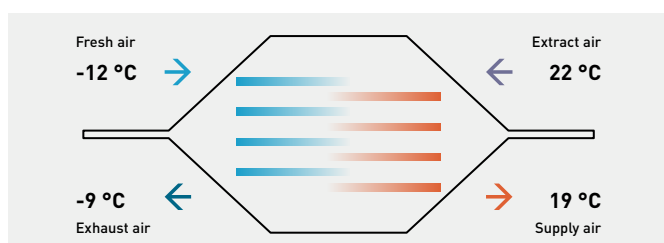

Counter flow ventilation units are equipped with two fans to supply and extract air. A cross-flow heat exchanger recovers the energy contained in the extracted air and transfers it to the supplied air. This significantly reduces the building's energy consumption, while at the same time keeping a good quality of the indoor air.

Aquarea Vent - Counter flow ventilation units



PAW-VENTX10-15-20-25Z-1

PAW-VENTX20-30-40-50V-1

PAW-VENTX20-30-40-50H-1



+ REFER TO PAGE 137 FOR THE COMPLETE LIST OF FILTERS AND ACCESSORIES FOR AIR DISTRIBUTION AND DIFFUSION SYSTEMS

Compact (Horizontal / Vertical mounting)		Air flow	Static pressure	Recovery efficiency	Energy class	Power supply	Power consumption	Sound power LWA	Dimensions / Net weight	Filter class	Duct connection
		Nominal / Max	Nominal / Max			Voltage / Phase / Frequency	Nominal		H x W x D		
		m <sup>3</sup> /h	Pa	%			W	dB(A)	mm / kg		
Universal mounting	<b>P-VEN15XQAZE5</b>	91/130	50/100	87	<b>A</b>	230 V / Single phase / 50 Hz	80	48	255x580x580 / 19	ePM1 80%	160
	<b>P-VEN20XQAZE5</b>	147/210	50/100	85	<b>A</b>	230 V / Single phase / 50 Hz	140	51	255x580x580 / 19	ePM1 80%	160
Horizontal mounting	<b>P-VEN15XQAEH5</b>	109/155	50/100	86	<b>A</b>	230 V / Single phase / 50 Hz	110	49	260x480x800 / 25	ePM1 80%	160
	<b>P-VEN30XQAEH5</b>	210/300	50/100	85	<b>A</b>	230 V / Single phase / 50 Hz	180	50	295x600x795 / 30	ePM1 70%	160
	<b>P-VEN35XQAEH5</b>	238/340	50/100	89	<b>A</b>	230 V / Single phase / 50 Hz	350	52	290x650x1150 / 38	ePM1 70%	160
	<b>P-VEN45XQAEH5</b>	288/455	50/100	88	<b>A</b>	230 V / Single phase / 50 Hz	420	56	290x1150x1150 / 40	ePM1 70%	160
Vertical mounting	<b>P-VEN15XQAVE5</b>	112/170	50/100	86	<b>A</b>	230 V / Single phase / 50 Hz	110	48	510x430x625 / 32	ePM1 80%	160
	<b>P-VEN30XQAVE5</b>	210/300	50/100	86	<b>A</b>	230 V / Single phase / 50 Hz	180	50	590x575x785 / 38	ePM1 70%	160
	<b>P-VEN40XQAVE5</b>	266/380	50/100	87	<b>A</b>	230 V / Single phase / 50 Hz	350	51	590x735x785 / 42	ePM1 70%	160
	<b>P-VEN45XQAVE5</b>	315/450	50/100	86	<b>A</b>	230 V / Single phase / 50 Hz	420	54	590 x 785 x 735 / 43	ePM1 70%	160

Control options.

Wall-mounted control with Modbus.

PCZ-AHRP0025

Wall-mounted control with integrated Wi-Fi for remote control via the Aquarea Home App.

PCZ-AHRP0026



- Integrated VOC - CO<sub>2</sub> air quality sensors
- Integrated humidity sensors
- Integrated temperature sensors
- Unit control and settings: Seasonal modes, temperature and fan speed ventilation settings
- Connectivity: Wi-Fi or Modbus

Vent PRO.

From selecting the right ventilation unit to planning the air distribution system and choosing the appropriate components, the Vent PRO guides you through every step to ensure the optimal solution for your project.

Access the tool via the 'Tools' section in the Panasonic Pro Club ([www.panasonicproclub.com](http://www.panasonicproclub.com)).

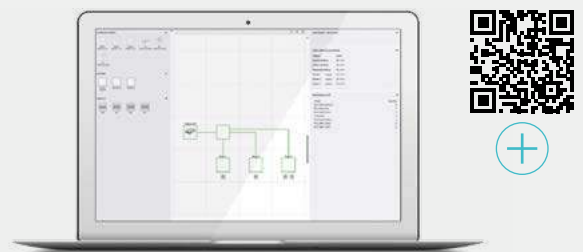

Remote control with Aquarea Home App

\* Requires Wi-Fi control or Home Network Hub PCZ-ESW737.

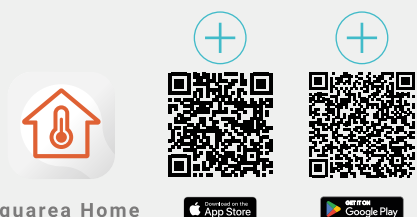



## Control and connectivity

Panasonic has developed a wide range of control systems to offer the best options for commercial and residential needs, from the individual remote controllers, to the newest technology capable of controlling your building anywhere in the world. The simple to use cloud software can even be used from a portable device.

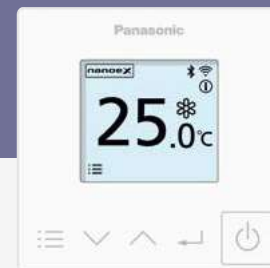

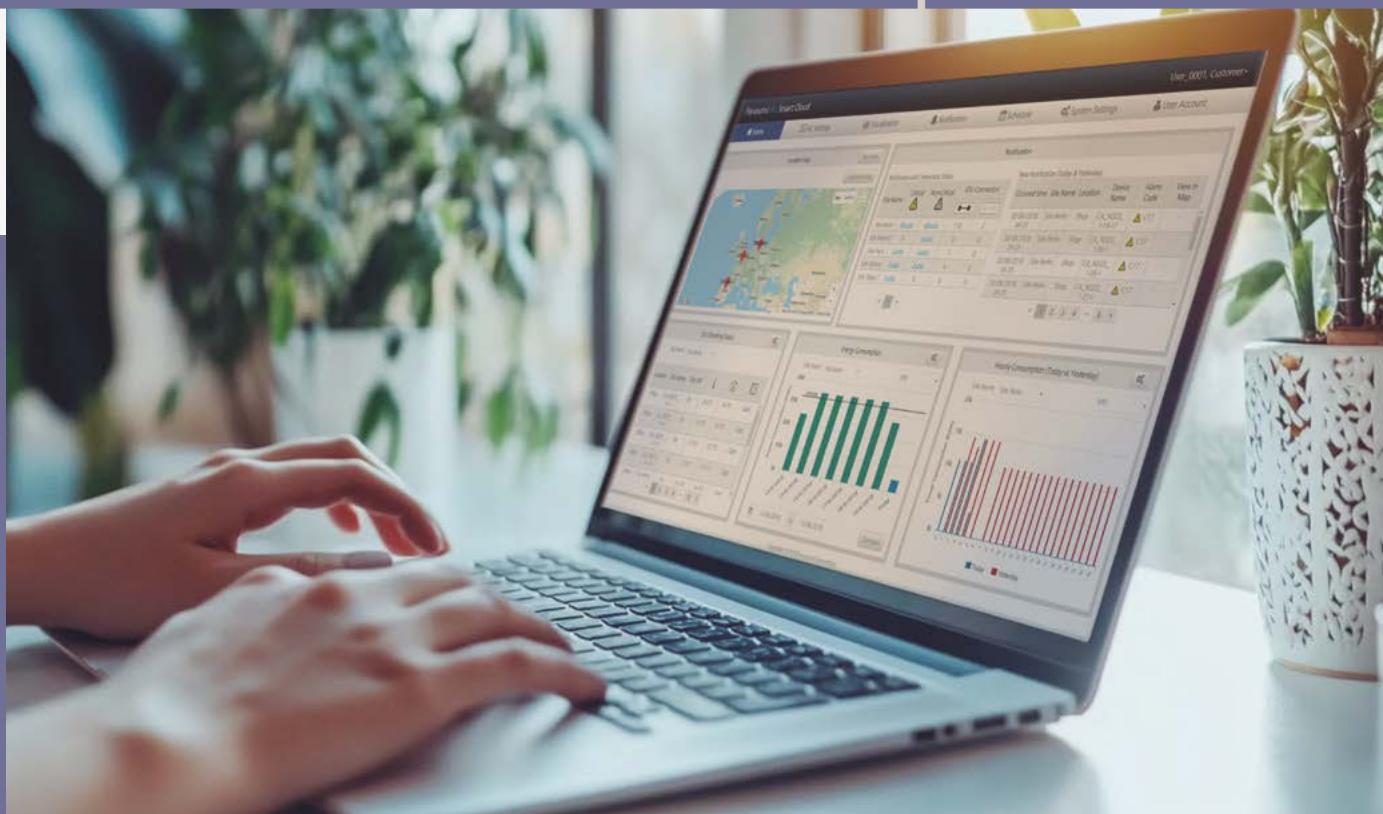

Control and connectivity map for Panasonic business area	→ 424	<b>Individual wireless controllers</b>	→ 458
VRF Smart Connectivity+	→ 426	Infrared remote controller	→ 458
Smart multi-site control solution	→ 430	Remote sensor	→ 458
Panasonic AC Smart Cloud	→ 432	<b>Centralised controllers</b>	→ 459
Panasonic AC Service Cloud	→ 434	System controller with schedule timer	→ 459
Panasonic AC Smart Cloud packages	→ 436	ON / OFF controller	→ 459
Commercial Wi-Fi Adaptor	→ 438	Intelligent controller (touch screen panel)	→ 460
CONEX. Devices and apps	→ 440	P-AIMS core software	→ 461
Remote controller with Econavi	→ 444	Local adaptor for ON / OFF control	→ 462
Intelligent controller	→ 446	Demand control for Mini ECOi outdoor units	→ 462
Econavi sensor	→ 448	Mini Seri-Para I/O Unit 0 -10 V	→ 463
Controller for hotel application	→ 450	Communication adaptor for VRF connectivity	→ 463
A united BMS interface with S-Link	→ 452	PACi NX and VRF connectivity	→ 464
Control and connectivity	→ 454	<b>PACi NX, ECOi and ECO G connectivity indoor units</b>	→ 466
<b>Individual controllers wired</b>	→ 456	T10 connector (CN061)	→ 466
CONEX wired remote controller	→ 456	Fan drive connector (CN032)	→ 467
Design wired remote controller	→ 456	Option connector (CN060) output external signals	→ 467
Room controller for hotel rooms	→ 457	EXCT connector (CN073)	→ 467
Display control for hotel rooms	→ 457		

# Control and connectivity map for Panasonic business areas

A wide range of control and connectivity solutions to suit a variety of applications. Integration capability, scalable solutions and smart connectivity offer a unique portfolio to meet every customer's needs.

## Integration with Home Automation or KNX.

Simple and flexible solution to integrate Panasonic heating and cooling systems into smart home energy solutions.



## CONEX.

Simple and intuitive control with smart apps availability <sup>1)</sup>. Each of the specialized apps, for owners or HVAC&R professionals, support daily operation. Allows connection of one, or a group of indoor units, to Panasonic Comfort Cloud App, which provides control, monitoring, scheduling and error alerts. Compatible with Voice Control <sup>2)</sup>.

+ REFER TO PAGE 440 FOR MORE DETAILS

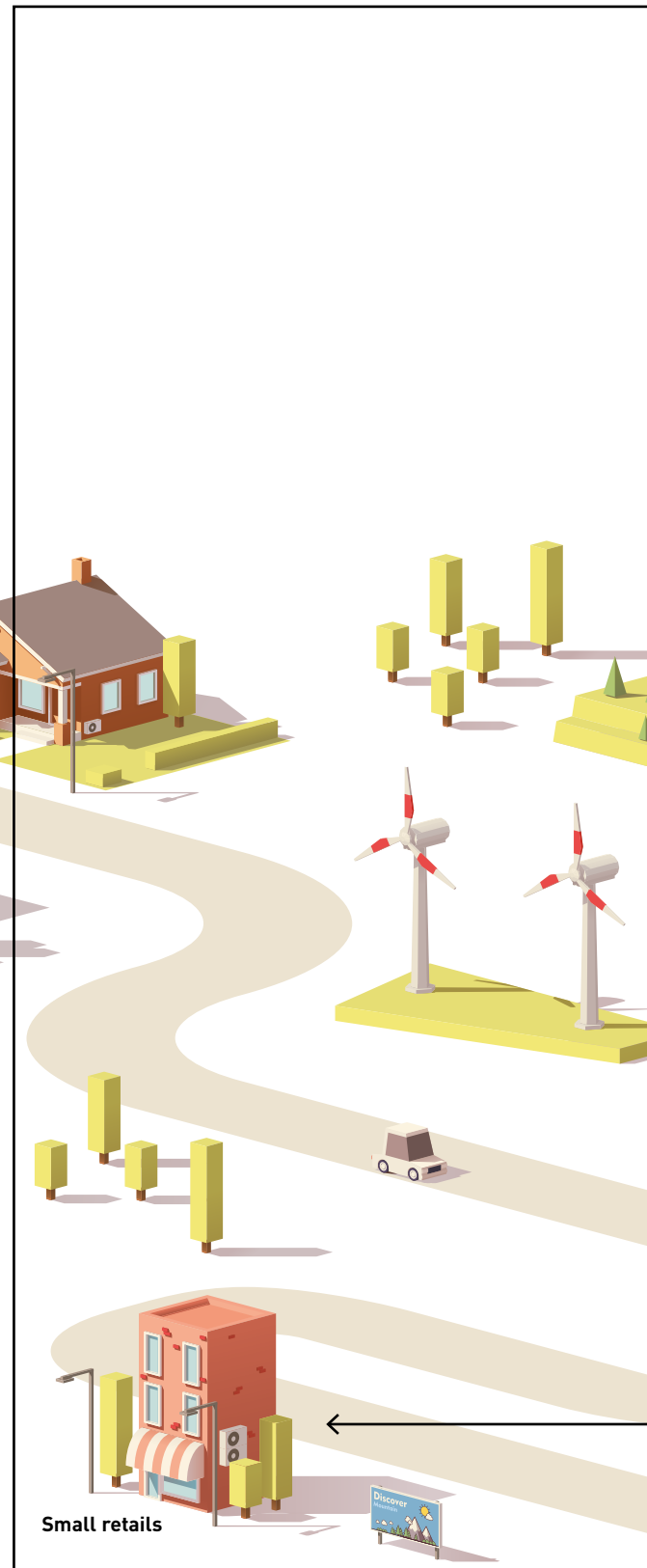

1) App connectivity available with CZ-RTC6WBL, CZ-RTC6BL, CZ-RTC6WBLW2 and CZ-RTC6BLW2.  
 2) Alexa, Google Home... Giving indication of compatible options.  
 3) Panasonic AC Smart Cloud connection required to access Panasonic AC Service Cloud.  
 4) 2 DI on standard version and 4 DI/DO available on Modbus version.  
 5) 128 indoor units as standard, additional communication adaptor required for 256 units.





**Panasonic AC Smart / Service Cloud.**

Smart multi-site solution provides users with complete scalable control for all business installations, 24/7, from any connected location.

Panasonic AC Smart Cloud for business owners and Panasonic AC Service Cloud<sup>3)</sup> for HVAC service/maintenance companies.

+ REFER TO PAGE 432 FOR MORE DETAILS

**Hotels**

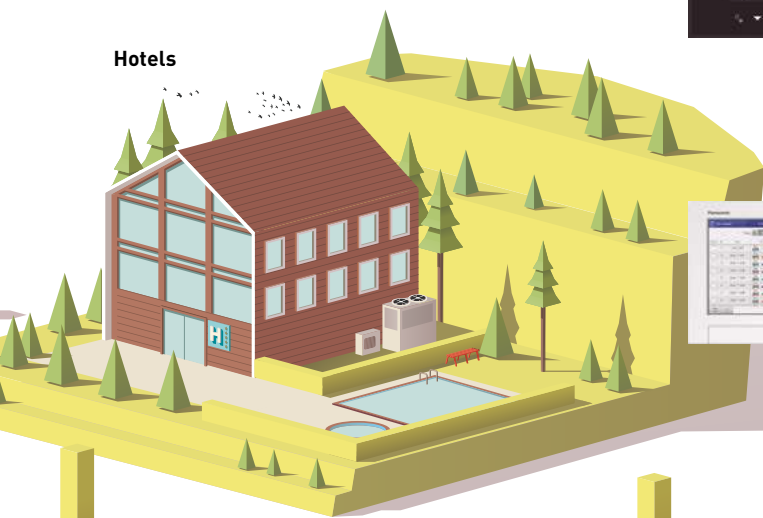

**VRF Smart Connectivity+.**

Control the air quality of guest rooms utilising CO<sub>2</sub> and humidity sensors. Easy BMS integration for entire building management.

+ REFER TO PAGE 426 FOR MORE DETAILS

**Controller for hotel application.**



Intuitive controller allowing up to 4 digital inputs and outputs<sup>4)</sup>. Perform the most common operations in hotel rooms, such as key cards and window contacts.

+ REFER TO PAGE 450 FOR MORE DETAILS

**Intelligent controller.**

Centralized controller with large LCD touch screen display. Maximum 256<sup>5)</sup> indoor units connectable, ideal for larger buildings.

+ REFER TO PAGE 446 FOR MORE DETAILS

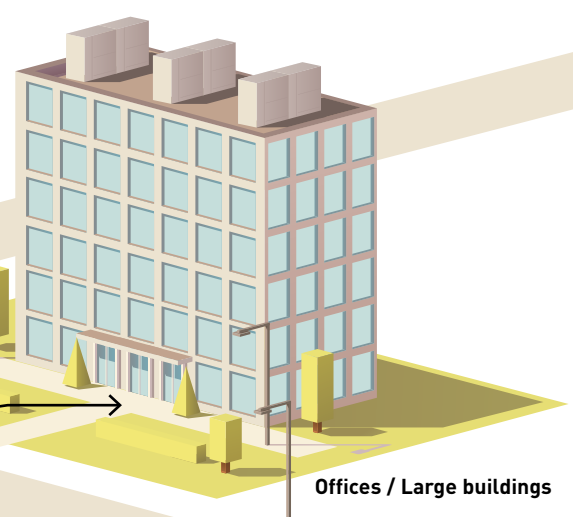

Offices / Large buildings

**Supermarkets**

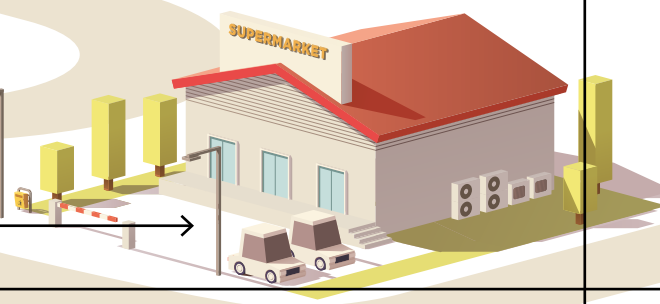

**Integration with BACnet or Modbus.**

Easy and reliable solution to integrate Panasonic heating and cooling systems into the building management systems in your business.

## VRF Smart Connectivity+

Through thorough energy management, Panasonic's VRF Smart Connectivity+ is a state-of-the-art solution providing energy saving and comfort as well as simple installation, operation and running.



VRF Smart Connectivity+ solution offers efficient energy management, high IAQ (indoor air quality), and air conditioning control.

**Panasonic** **Schneider**  
Electric



#### Dramatic reduction of OpEx with outstanding IAQ.

3 built-in sensors: Temperature, RH and occupancy.  
ZigBee wireless sensors: CO<sub>2</sub> / temperature / RH%, window / door, ceiling / wall / water leakage. Relay Pack.



#### Ultimate customisation.

Customisable colour background.  
Custom display/icons, messages.  
Programmable logic (also stand alone).  
Various controls and various external connection devices.



#### User-/owner-friendly.

Colour touch screen.  
Simple and easy to use.  
22 languages.  
Easy-to-understand error description.

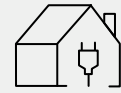

#### Easy design and Plug & Play to reduce CapEx.

Simple Plug & Play VRF connection to Building Energy Management System (BMS).  
Stand alone or BMS connected.  
Easy installation of ZigBee sensors.

#### Energy management system for rooms.

Each room is monitored by precision sensors, making it possible to provide high comfort levels without wasting energy.



#### Management system for the entire building.

A Building Energy Management System (BMS) can also be connected with Plug & Play centralised control of the entire building's energy consumption.

VRF Smart Connectivity+  
SER8150.

### 1 Air quality control

Optimum IAQ is realized using the CO<sub>2</sub> and humidity sensors. The interior environment remains comfortable, while heating and cooling costs are minimized.  
The CO<sub>2</sub> sensor can control ventilation systems, which contribute to improving the room's air quality.

### 2 Easy installation and integration

A single device is all that's required for occupancy and optimum automatic indoor air quality (IAQ) control. Simple operation with an interface that it is not an owned device contributes to increased energy efficiency and productivity for reduced capital expenditure (CapEx) and operating expense (OpEx).

### 3 Other equipment control

One room controller manages various devices including lighting and the blinds.  
Control ventilation systems and other external connection devices with this BMS.



**Door/window wireless sensor.**  
Door and window contact detection sensor to monitor opening and closing.



**Wall/ceiling motion/temperature/humidity sensor.**  
Wall and ceiling sensor to detect the presence or absence of occupants.



**CO<sub>2</sub> /temperature/humidity sensor.**  
Monitor indoor air quality, review data on interfacing devices, and control fresh air inside customisable zones.



**Water leakage sensor.**  
Two sensing pads under the body activate when water is present between the two pads. Detecting the water, the sensor reports the event to the controller (and BMS).

# VRF Smart Connectivity+

Energy management system for rooms.

By installing a wall/ceiling motion temperature sensor, window/door sensor, and CO<sub>2</sub> sensor in the room, ideal, waste-free air conditioning is achieved.

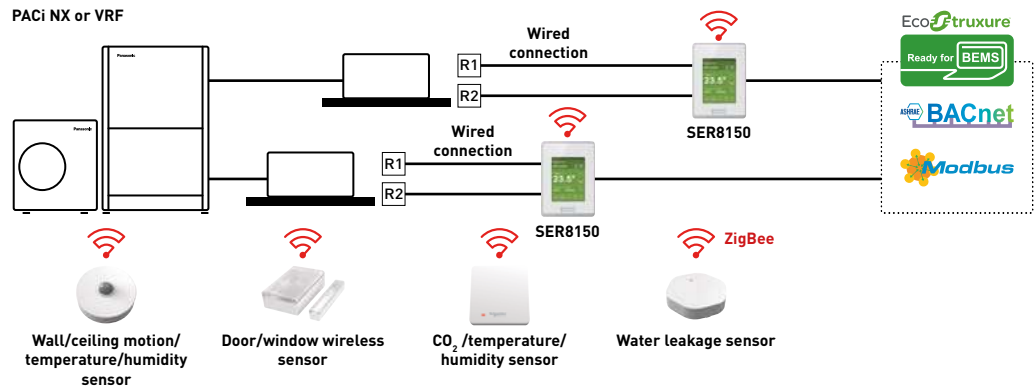

## Sensing and control technology

Using sensors from Schneider Electric, high-quality occupancy and automatic IAQ control are realised. The sensors detect the presence or absence of occupants, and the opening and closing of doors and windows to achieve the most efficient energy management and exceptional air-conditioned comfort.

Flexible installation is possible to match different applications and building features such as walls, ceilings and proximity to doors and windows. No wiring means extra installation versatility.

Batteries last for up to five years (10-year battery for CO<sub>2</sub> sensor) and are easy to install and replace.

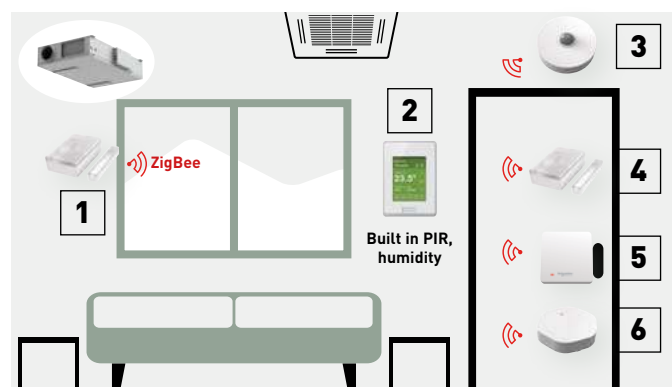

- 1 | Window sensor (option).
- 2 | Room controller.
- 3 | Ceiling motion sensor (option).
- 4 | Door sensor (option).
- 5 | CO<sub>2</sub> sensor (option).
- 6 | Water leakage sensor (option).

## VRF Smart Connectivity+

### Remote controllers



Remote controller Panasonic Net Con, RH, No PIR, R1/R2. SER8150R0B1194



Remote controller Panasonic Net Con, RH, PIR, R1/R2. SER8150R5B1194



Wireless ZigBee® Pro module / Green Com card. VCM8000V5094P

Up to 5 year battery life (batteries included). Battery life of CO<sub>2</sub> sensor up to 10 years. Battery level is a data point.

### Sensors



Door/window wireless sensor. SED-WDC-G-5045



Wall/ceiling motion/temperature/humidity sensor. SED-MTH-G-5045



CO<sub>2</sub>/temperature/humidity sensor. SED-CO2-G-5045



Temperature/humidity sensor. SED-TRH-G-5045



Water leakage sensor. SED-WLS-G-5045

### Cover frames



Cover frame. Silver. FAS-00



Cover frame. White. FAS-01



Cover frame. Glossy translucent white. FAS-03



Cover frame. Light tan wood. FAS-05



Cover frame. Dark brown wood. FAS-06



Cover frame. Dark black wood. FAS-07



Cover frame. Brushed steel finish. FAS-10

# VRF Smart Connectivity+

Smart management solutions.



## 1 Hotels

### Room key card or key cardless solutions for hotels.

The SER8150 and ZigBee sensor automatic detection function offer optimal air conditioning regardless of whether there is a hotel room key or not. Sensors detect the presence or absence of occupants and the opening and closing of doors and windows for the optimum air-conditioned environment guests expect. Automatic control ensures the most efficient operation when guests are away or when windows are open. This contributes to an appreciable reduction in operating costs.



## 2 Small and medium offices

### CO<sub>2</sub> sensors (option) and humidity sensors.

CO<sub>2</sub> sensors take measurements in units of ppm, and humidity sensors enable fine air quality control. This creates the most comfortable space for occupants while contributing to improved employee satisfaction.



## 3 Super markets

### Humidity sensors.

Humidity sensors enable automatic dehumidification for the optimum IAQ regardless of climatic conditions. This creates an even more comfortable environment for customers and employees.

## Innovative and unrivalled advantages



### Colour and design to match office interiors.

Colour combinations and design can be set to match different facilities.



### Easy-to-understand error description.

Error description during an emergency is easy to understand, enabling staff to respond quickly.



### Customisation in 22 languages possible.

The display can be customised to match the native languages of guests to enable smooth, stress-free communication for hospitality at its finest.

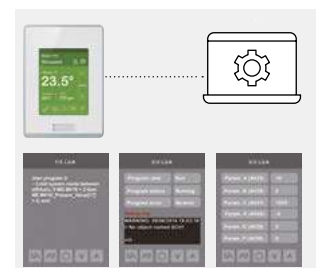

### Programmable logic.

Full customisation and updating of remote controller logic to match conditions.

## Smart multi-site control solution

Modern and scalable energy management for your Heating & Cooling Solutions.

Smart multi-site control solution. One screen with endless possibilities.

The smart multi-site control solution from Panasonic allows you to have complete control of all your installations. With a simple click, all your units from several locations receive status updates in real-time, preventing breakdowns and optimising costs.



Panasonic  
AC Smart Cloud

Panasonic  
AC Service Cloud



### Installation.

Easy installation and configuration.



### Connectivity.

A standard LAN connection with internet access (fibre or mobile).



### Reliability.

24/7/365 days connection.



### Use.

Real-time control from anywhere.



### Roles and permission.

Easily configure different access roles for each user.



### Security.

Highly secure communication and complaint with GDPR.

What Panasonic provides you?



**Energy savings.**

**AC can be between 40-60% of the total electricity bill.**

Even small setting changes can provide a huge impact in energy savings for your buildings.

Panasonic AC Smart Cloud provides you energy consumption data of your site(s) and energy saving functions such as control setting limitation, auto off, scheduling, temperature range limits, etc.



**Healthy comfort.**

**How to secure a comfortable environment by avoiding incorrect AC operation?**

Incorrect temperature settings can create discomfort for users as well as and unhealthy environment for employees, visitors or customers. Analyse the set point and room temp history, and fix the right mode and temperature for each room.

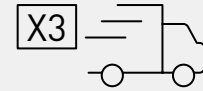

**Service speed.**

**On average, 2-3 AC technician' visits are required on site when an error/ issue appears in an AC system.**

Avoid wasted site visits, analysing the behavior of the AC system remotely without the need of a technician visit on site.



**Downtime.**

**System "downtime" can impact the customers buying experience / productivity.**

Keep your business running, reducing the risk of system downtime. Detect potential failures in advance or fixing them swiftly should issues occur.



**Maintenance.**

**A proper maintenance schedule prevents future malfunctions and reduces energy consumption.**

Remotely check all the advanced parameters of the system and plan the maintenance properly. Assign the right engineer for the required task.



**Life of system.**

**Replacing HVAC is a huge impact on investment.**

Making good use of the system, taking earlier action when abnormal signal occurs and keeping regular maintenance will expand the life your system, but will also keep the expected performance operation.

**Full multi-site and user control**

Panasonic Smart and Service Cloud is based on location. Each location can allow access for multiple users whether in the same building or via remote access. The scalability allows addition of multiple sites and customise the access of your team and the access of your trusted service partner.

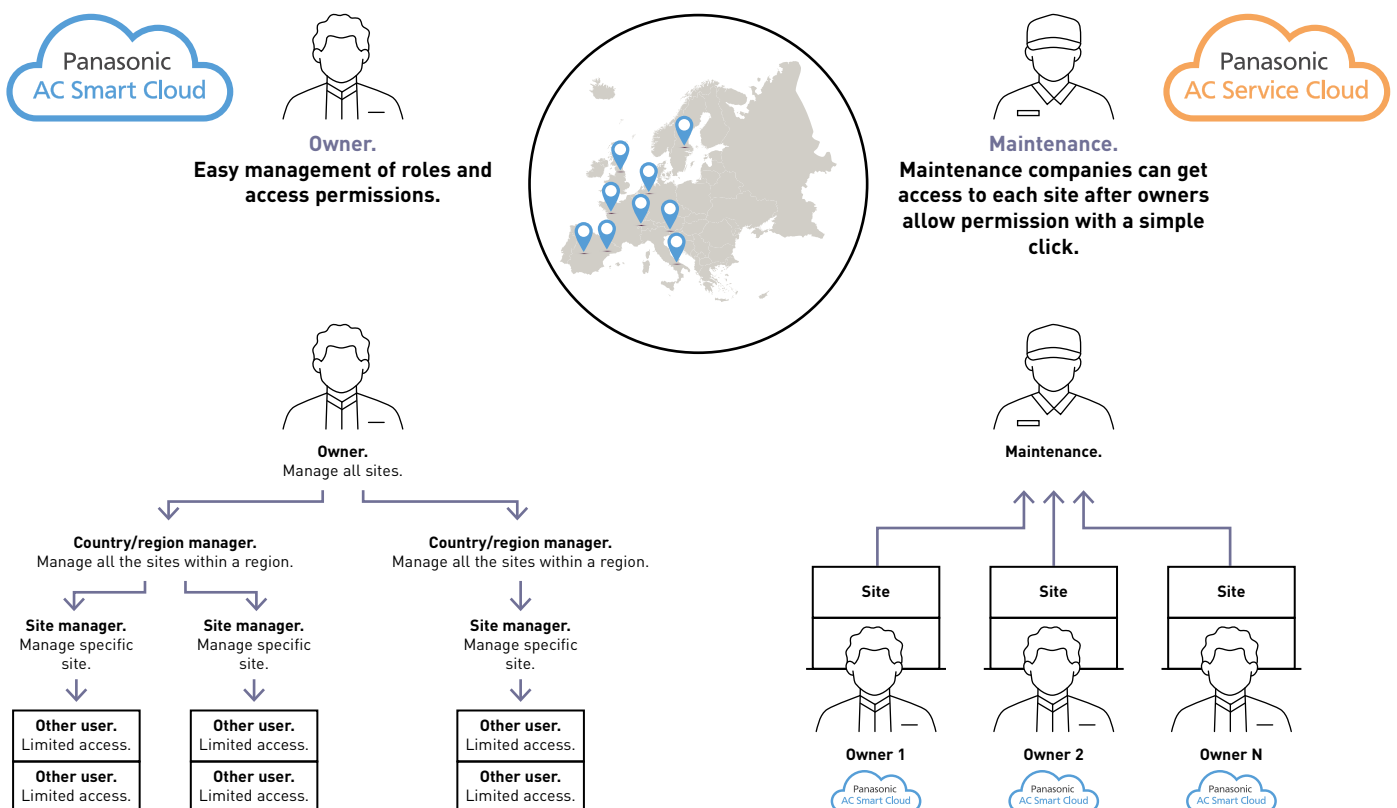

# Panasonic AC Smart Cloud

Centralise control of your business premises, from wherever you are, 24/7/365.

The AC Smart Cloud system from Panasonic allows you to have complete control of all your installations from your tablet or from your computer. In a simple click, receive status updates, from all of your installations wherever the location, reducing potential breakdowns and optimising costs.



**1 Comfort**  
Keep the comfort of workers, visitors, and customers to increase satisfaction and productivity.

**2 Return on investment**  
Optimising the operation of your heating and cooling system and the possibility to monitor remotely can expand the life of your assets.

**3 Lower running cost**  
Controlling settings in real-time and monitoring energy consumption contributes to reducing your energy bill.

### Flexible solution for your business

### Scalable solution for your business



Anytime



Anywhere

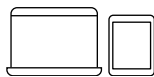

Multiplatform

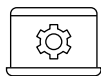

Internet browser

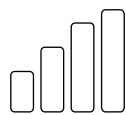

Small to large

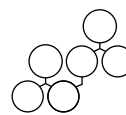

1 to multi-sites

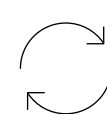

Upgrade features <sup>1)</sup>

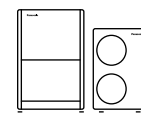

RAC<sup>2)</sup>/PACi NX/ECOi/ECO G

1) Customized to meet user demand / Continuous upgrades: new functions and product introductions / IT smart management. 2) CZ-CAPRA1 is required.

## Key functions and uniqueness



**Multi-site monitoring.**  
· It doesn't matter how many sites you have. It is easy to manage, operate, compare sites, locations and rooms.



**Powerful statistics for energy savings.**  
· Power consumption, capacity and efficiency level can be compared with different parameters (yearly / monthly / weekly / daily basis)



**Schedule setting.**  
· Set yearly / weekly / holidays timers as you please



**Maintenance notification.**  
Receive an error notification by email with floor layout:  
· Maintenance notification of ECOi / ECO G outdoor units  
· Remote service checker function



## Controller multi-site.

Including all advantages for single site, the scalability of AC Smart Cloud offers you an excellent toll for multi-site management.

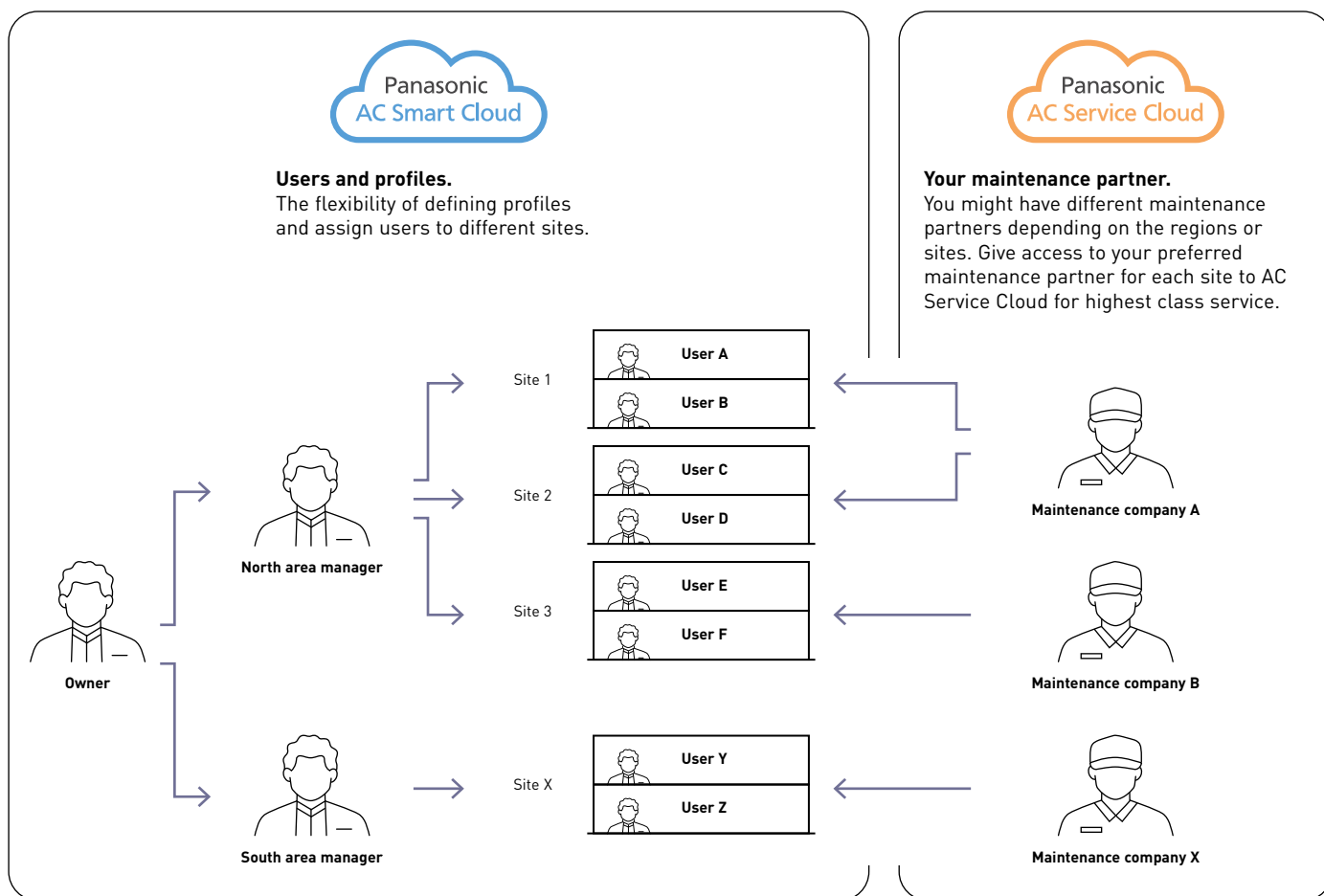

### List of features

Panasonic AC Smart Cloud	Functionalities
Home screen	Overview of: operating status, location map, weather information, notification, energy consumption, efficiency, eco-friendly building list
AC settings	Indoor unit monitoring and remote control, outdoor unit details, cloud adapter details, floor map view, maintenance notification (installer)
Visualization	Statistical data regarding energy consumption, capacity and efficiency ranking; per indoor unit, unit group or refrigerant circuit
Notification	Warnings and alarms, maintenance intervals
Schedule	Schedule settings and results
Energy saving	Temperature range limits, unattended auto shutoff, temperature auto return, energy saving timer, demand/peak shaving
Demand control	Indoor unit and outdoor unit demand settings
Event control	Control inputs: alarms, digital inputs, indoor units. Control outputs: digital outputs, indoor units
System settings	CO <sub>2</sub> factor, distribution groups, area allocation, cut-off requests, site management, group display, site location, software version
User account	New user registration, updating users, user lists, user roles
Floor map Editor	Floor map import and unit assignment
Help	Installer information, alarm mail setting, user data, account management, company / customer information, terms of use, privacy notice, cookie policy, user manual, FAQ. For installers: user manual, technical data, installation instructions
Additional functions for installers	Cloud adapter installation process, remote service checker data recording and download, remote cloud adapter firmware update

# Panasonic AC Service Cloud

Panasonic AC Service Cloud provides maintenance companies a unique tool to deliver advanced service and maintenance features, decreasing response times, reduce sites visits and better allocate resources.



**1 Response time and zero down time**  
Providing technical information about abnormalities and checker functions enables the AC installer and maintainer to remotely identify and fix issues more quickly, even before they occurs.

**3 Maintenance planning**  
With a simple click, easily identify the nature of potential issues, enabling issue classification, prioritisation of resources and better planned site visits, assigning the right engineer for the job.

**2 Reduce unnecessary trips**  
It reduces the cost of unnecessary trips, reducing the CO<sub>2</sub> emissions associated with transport.

**4 All at a glance with scalability**  
Remotely view all sites requiring maintenance of Panasonic HVAC. Increase the number of sites maintained, taking advantage of future updates and features of the Panasonic AC Service Cloud.

## Key functions

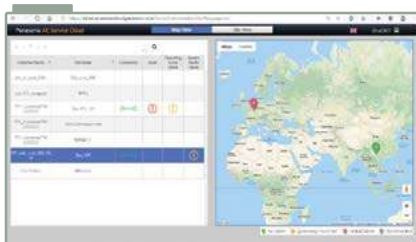

All sites at a glance.



Topology.



Floor map view.



Alarm status.

Owners can manage different maintenance companies for each site, enabling or disabling access with just one click. Maintenance companies can have access to all sites where different owners allow permissions.

**System health check function**

Self diagnosis function is available in the AC Service Cloud. It automatically predicts potential malfunctions and helps to speed up your service process.

- Consecutive automatic monitoring at 15 minute intervals
- Key notifications in the event potential malfunction is detected
- 2D graph display to help with detailed analysis
- Threshold values can be easily adjusted

\* For compatible models, please contact an authorized Panasonic dealer.

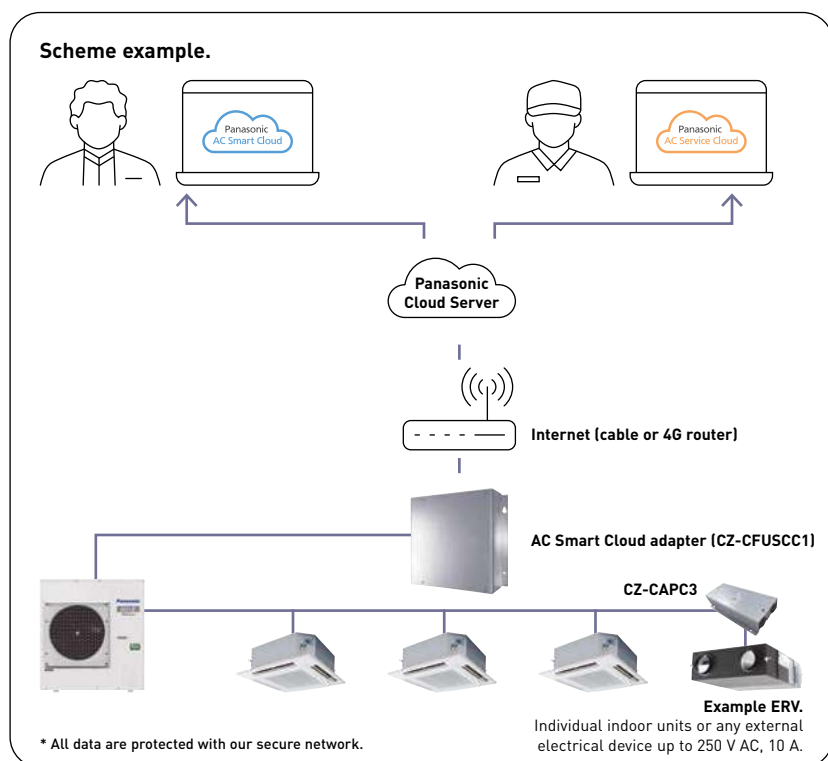
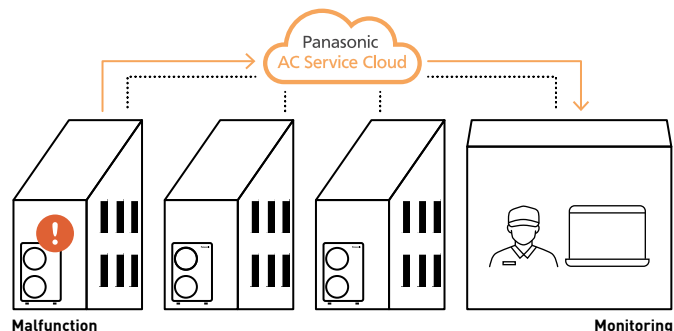

**Technical requirements:**

- CZ-CFUSCC1 – AC Smart Cloud adaptor
- Internet connection via: LAN with access to internet

**Optional hardware:**

- CZ-CAPRA1 – integration of RAC systems
- Pulse meters (supplied by others): up to 3 pulse meters (gas or power meters) can be connected to the cloud adaptor, extendable by additional communication adaptors (CZ-CFUSCC2)
- CZ-CAPC3 - ON / OFF monitor and control

**Systems supported by AC Smart Cloud adapter:**

- ECOi
- ECO G
- PACi NX
- RAC (CZ-CAPRA1 interface is required)
- ERV (CZ-CAPC3 interface is required)

**List of features**

<b>Panasonic AC Service Cloud Functionalities</b>	
Home screen	Map view and site view with site names, connection status and alarm status
Status	Alarm status, site topology, remote service checker, indoor unit monitoring and remote control, outdoor unit details, floor map view with service manual download
Statistics	Refrigerant circuit view (current data and recorded data), data table view, 2D graph view
Maintenance settings	Notifications and alarms, maintenance intervals setting (operating hours)
Customer list	List of connected customers, requests to access customer sites
Cloud adaptor	Cloud adaptor installation wizard, remote firmware update
Floor map editor	Floor map import and unit assignment
Help	Alarm mail setting, user data, account management, company / customer information, terms of use, privacy notice, cookie policy, user manual, user manual, technical data, installation instructions, FAQ
System health check function*	Self diagnosis function is available in the Panasonic AC Service Cloud. It automatically predicts potential malfunctions and helps to speed up your service process

\* Optional.

## 1 Panasonic AC Smart Cloud packages

Get the cloud base kit (CZ-CFUSCC1 + start up) and register to one of the subscription periods with or without data connectivity.

The selection of the right Panasonic AC Smart Cloud package depends on the size of the installation.

	Product	Reference	Items included in a kit	Description
<b>Up to 32 indoor units</b>	Cloud base kit	KIT-ACSCBASE32	CZ-CFUSCC1	Cloud adapter for PACi, ECOi and ECO G <sup>1)</sup>
			SR-ACSCSTART32	AC Smart Cloud start up to 32 indoor units
	AC Smart Cloud access fee	SR-ACSC1Y32		AC Smart Cloud access fee for 1 year
	AC Smart Cloud access fee with data connectivity	SR-ACSC1Y32CNT		AC Smart Cloud access fee for 1 year with data connectivity
<b>Up to 64 indoor units</b>	Cloud base kit	KIT-ACSCBASE64	CZ-CFUSCC1	Cloud adapter for PACi, ECOi and ECO G <sup>1)</sup>
			SR-ACSCSTART64	AC Smart Cloud start up to 64 indoor units
	AC Smart Cloud access fee	SR-ACSC1Y64		AC Smart Cloud access fee for 1 year
	AC Smart Cloud access fee with data connectivity	SR-ACSC1Y64CNT		AC Smart Cloud access fee for 1 year with data connectivity
<b>Up to 128 indoor units</b>	Cloud base kit	KIT-ACSCBASE128	CZ-CFUSCC1	Cloud adapter for PACi, ECOi and ECO G <sup>1)</sup>
			SR-ACSCSTART128	AC Smart Cloud start up to 128 indoor units
	AC Smart Cloud access fee	SR-ACSC1Y128		AC Smart Cloud access fee for 1 year
	AC Smart Cloud access fee with data connectivity	SR-ACSC1Y128CNT		AC Smart Cloud access fee for 1 year with data connectivity
<b>Up to 512 indoor units</b>	Cloud base kit	KIT-ACSCBASE512	4x CZ-CFUSCC1	Cloud adapter for PACi, ECOi and ECO G <sup>1)</sup>
			SR-ACSCSTART512	AC Smart Cloud start up to 512 indoor units
	AC Smart Cloud access fee	SR-ACSC1Y512		AC Smart Cloud access fee for 1 year
	AC Smart Cloud access fee with data connectivity	SR-ACSC1Y512CNT		AC Smart Cloud access fee for 1 year with data connectivity

<sup>1)</sup> The adapter has to be sold always together with start up. \* One cloud adapter is required per 128 indoor units. \*\* Model references up to 192/256/320 indoor units are also available.

## 2 Panasonic AC Service Cloud

	Product	Reference	Description
Service function	Panasonic AC Service Cloud	SR-ACSC1Y32M	AC Service Cloud access for 1 year up to 32 indoor units
	System Health Check <sup>2)</sup>	SR-ACSC1Y32SHC	System Health Check access for 1 year up to 32 indoor units

<sup>2)</sup> AC Service Cloud is required to use this function.

## 3 Optional services

Product	Reference	Items included in a kit	Description
Floor map <sup>3)</sup>	SR-ACSC1FLRUP		Upload 1 floor map or maximum 32 units
Floor map <sup>3)</sup>	SR-ACSC1FLRCP		Create 1 floor map or maximum 32 units
Indoor assign <sup>3)</sup>	SR-ACSC32ASSIGN		Assign indoors up to 32 units
4G connectivity kit <sup>4)</sup>	KIT-ACSC4GCNT	PAW-ACSCRTR4G	AC Smart Cloud 4G connection kit including 4G router and SIM card
		PAW-ACSCSIM	
4G Router	PAW-ACSCRTR4G		4G Router for Panasonic AC Smart Cloud
SIM card	PAW-ACSCSIM		SIM card without data amount

<sup>3)</sup> Floor map and indoor assignments can be done by customer without additional charge. <sup>4)</sup> Data amount of SIM card is not included.

# Selection steps

What service do you need? There are 2 options as follows.

## AC Smart Cloud only.



Please follow step: **1**

## AC Smart Cloud + AC Service Cloud.



Please follow step: **1** **2**

\* AC Smart Cloud is always required to use Panasonic AC Service Cloud.

### 1 Setup for AC Smart Cloud.



+



**Annual  
access fee**

**1 | Determine your number of indoor units.**

**2 | Select the appropriate cloud base kit.**

**3 | Select your annual access fee options with and without data connectivity.**

\* One cloud adapter (CZ-CFUSCC1) is required per site.

### 2 Setup AC Service Cloud



The service cloud subscription (SR-ACSC1Y32M) is for up to 32 indoor units as standard. For larger systems exceeding this indoor unit quantity, multiple packages are required. For example, please order 2 units of SR-ACSC1Y32M if the number of indoor units is from 33 to 64. If system health check function is required in AC Service Cloud, choose SR-ACSC1Y32SHC.

### 3 Choose optional services to suit your needs.

- Floor map upload
- Floor map creation
- Indoor assign
- Power meter
- 4G connectivity

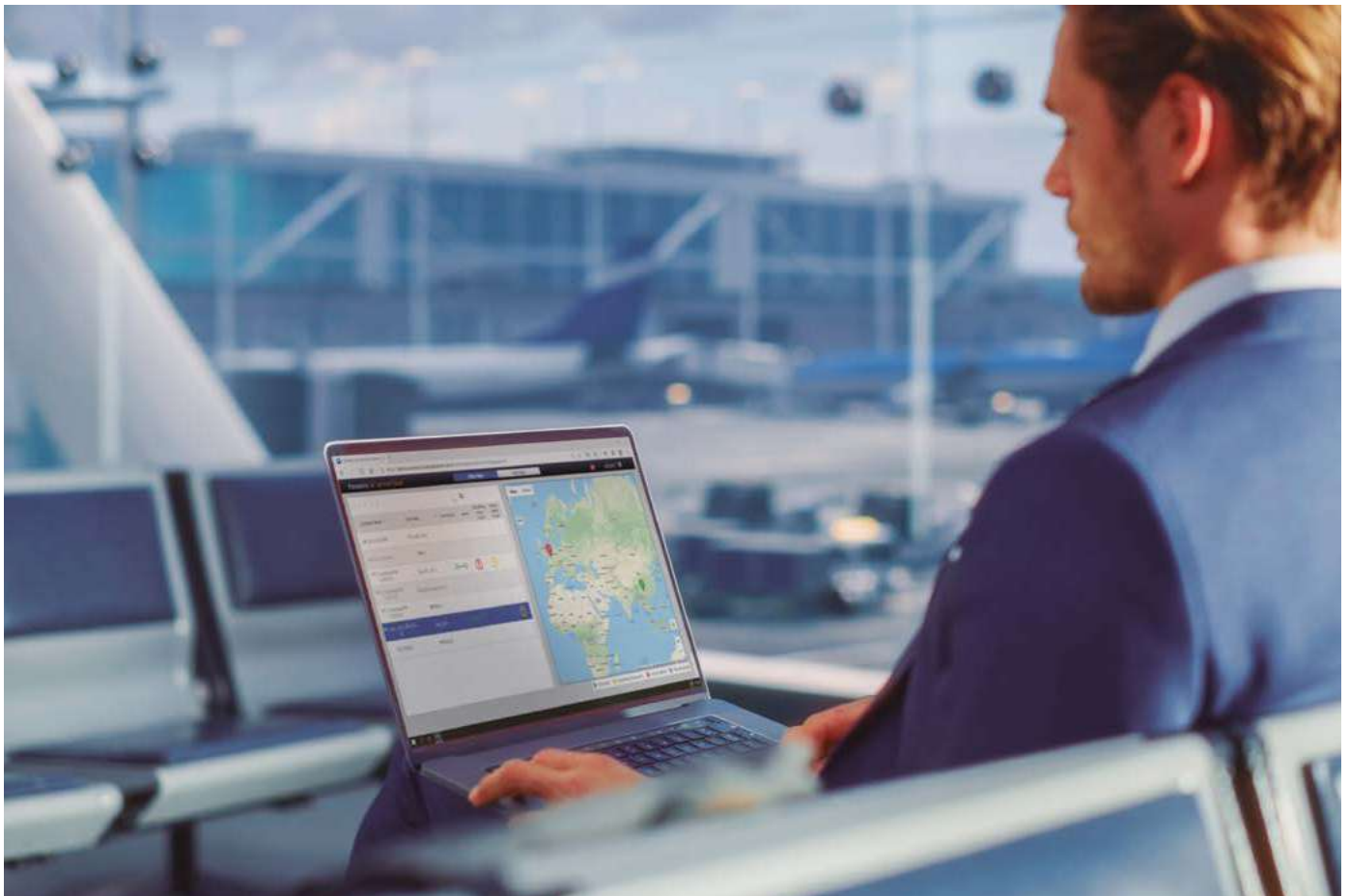

## Commercial Wi-Fi Adaptor

Panasonic CZ-CAPWFC2 interface adaptor, allows connection of one or a group of indoor units to Panasonic Comfort Cloud App, which provides control, monitoring, scheduling, and error alerts. Control PACi NX, ECOi, and ECO G indoor units with your smartphone whenever and wherever you are, by using Panasonic Comfort Cloud App and Commercial Wi-Fi Adaptor.

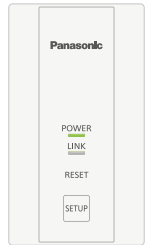

**1 From 1 to 200 units**  
User can control up to 10 different sites, with up to 20 units / groups per site. Additionally, one adaptor can be connected to 1 indoor or to a group of up to 8 indoors.

**2 Voice control compatible**  
Registering the unit to Panasonic Comfort Cloud App makes it compatible with the most popular voice assistants.

**3 Multi user**  
The Panasonic Comfort Cloud App allows multi-user access control, whilst allowing user restriction to specific units.

**4 Easy scheduling**  
Complex weekly scheduling made simple. Not only for one unit, but across multiple sites, and from a smartphone.

**5 Energy monitor**  
See the estimated power consumption and compare with other periods, to see how energy consumption can be further reduced. Check list of units that provides consumption\*.

\* Function available depending on the model.

**6 Error codes**  
Error code notification through the App, provides early notification and allows for faster repair.



### Advanced smartphone control

This scalable solution is ideal for one system, one site or multiple locations. Coupling the adaptor with the already feature rich systems, makes it an ideal solution for residential and commercial applications.



### Connection diagram

Commercial Wi-Fi Adaptor wiring length is 1,9 m and connects to indoor unit via T10 connector and R1/R2 terminal connectors.

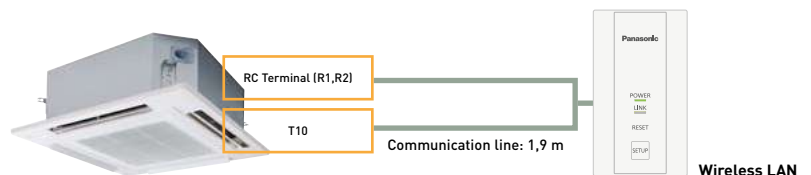

### Download free app: Panasonic Comfort Cloud App.

Other hardware requirements: Router and Internet (purchase and subscribe separately). Panasonic Cloud Server is designed, operated and managed by Panasonic.

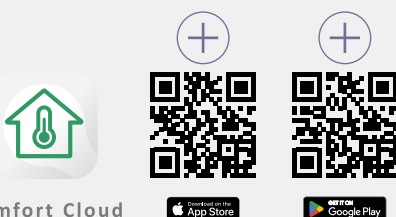

Input Voltage	12 V DC (supplied from T10 connector)
Power Consumption	Maximum 2,4 W
Size (HxWxD)	120 x 70 x 25 mm
Weight	190 g (including communications lines)
Interface	1 x Wireless LAN
Wireless LAN Standard	IEEE 802,11 b/g/n
Frequency Range	2,4 GHz band
Operating range	0 ~ 55 °C, 20 ~ 80 RH%
Connectable indoor unit	1 unit
Length of communication line	1,9 m (included)

## CONEX. Devices and apps

CONEX provides comfort and control for varying user needs. Accessible, flexible, and scalable with different controllers and apps. Perfectly meeting requirements of modern controls for end user, installer, and service.



Comfort Cloud





Intuitive operation with simple and modern design panel.  
Sophisticated design with white or black flat panel and compact body. From residential to commercial, the wired remote controller series perfectly matches with all kinds of modern building.  
It enables user to recognize each function with a simple glance.

REFER TO PAGE 456 FOR MORE DETAILS

## 1 Intuitive control with stylish design

- Simple operation at a glance
- Clean face with full flat and LCD display
- Compact body, only 86x86 mm



## 2 Control comfort with your smartphone

- Flexible control options with IoT integration
- Panasonic H&C Control App for daily remote control operation
- Panasonic Comfort Cloud App for remote operation 24/7/365

## 3 Easy maintenance with service support app

- Quick and easy app set-up for system setting
- Panasonic H&C Diagnosis App enables the user to obtain detailed system operation data\*

\* The use of apps depends on the remote controller model.

### CONEX with IoT integration

CONEX

The wired remote controller series is fully integrated with IoT solutions developed by Panasonic. Detailed operation, maintenance setting and service operation are all possible with smartphone or tablet.

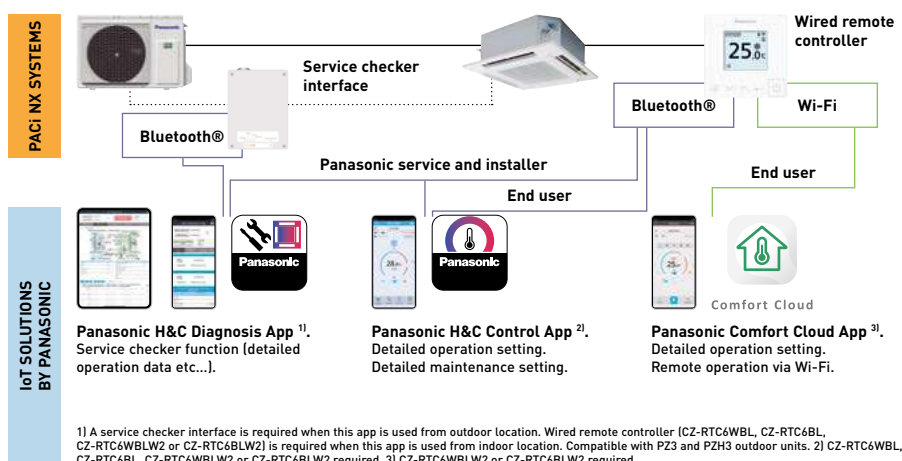

### Service checker interface.

The service checker interface provides easy access to service parameters and service checker data via Bluetooth®.

- A Service checker interface for PACi NX Series\*
- Bluetooth® connection
- Panasonic H&C Diagnosis App

\* Available as a spare part, compatible with PACi NX Series.

Input voltage	220-240 V ~ 50-60 Hz (supplied from outdoor unit)
Power consumption	Maximum 2,4 W (including outdoor units)
Size (HxWxD)	175 x 125 x 50 mm
Weight	—
Interface	Bluetooth® 4.2 or later
Frequency range	2,4 GHz band*
Operating range - Temperature / Humidity	0 ~ 40 °C / 20 ~ 80% (no condensation)

\* Frequency band in which the radio equipment operates; 2402 - 2480 MHz.

\* Maximum radio-frequency power transmitted in the frequency bands in which the radio equipment operates; +0 dBm.



# CONEX. Devices and apps

Flexible control options with IoT integration. 3 different apps for individual usage.

## Panasonic H&C Diagnosis App for service and installer

Tool for diagnosis and troubleshooting.

### Available functions:

- AC control
  - System view
  - Refrigerant circuit view
- Real-time data
  - Indoor unit
  - Outdoor unit
- Refrigerant cycle diagram and graph
- Data recording
- History data
- Error code tables

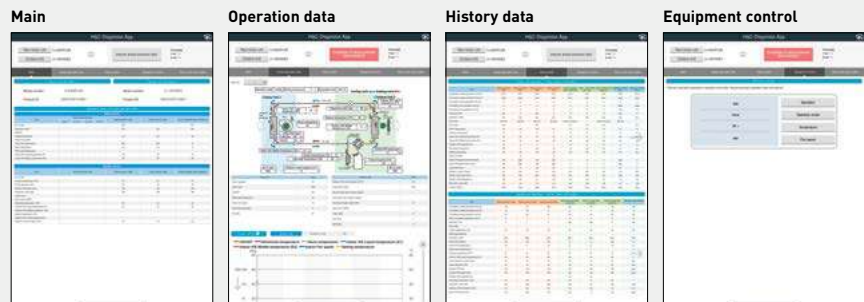

## Panasonic H&C Control App for end user, service and installer

Detailed operation setting. Detailed maintenance setting.

### Available functions:

- ON / OFF, mode, temperature, air flow volume, air flow direction
- Weekly timer
- All energy saving functions
- Alarm display and history
- Filter sign
- Test run
- Sensor value monitor
- Simple setting mode
- Detailed setting mode
- Key lock
- Ventilation fan control
- Display contrast adjustment
- Rotation, redundancy
- Quiet mode
- nanoe™ X
- Power consumption
- Unit naming



## Panasonic Comfort Cloud App for end user

Remote operation via Wi-Fi.

### Available functions:

- ON / OFF
- Mode
- Temperature
- Air flow volume
- Air flow direction
- Weekly timer
- Temperature setting range limitation
- Energy monitoring
- Alarm display
- nanoe™ X



Comfort Cloud



## Connectivity matrix.



White model	CZ-RTC6W	CZ-RTC6WBL	CZ-RTC6WBLW2
Black model	CZ-RTC6	CZ-RTC6BL	CZ-RTC6BLW2
Wired connection compatible with	PACi NX, ECOi, GHP	PACi NX, ECOi, GHP	PACi NX only
Wireless functions	No wireless capability	Bluetooth®	Bluetooth® + Wi-Fi
<b>App compatibility</b>			
Panasonic Comfort Cloud App	—	—	✓
Panasonic H&C Control App	—	✓ PACi NX, ECOi, GHP	✓ PACi NX only
Panasonic H&C Diagnosis App <sup>1)</sup>	—	✓ PACi NX only <sup>2)</sup>	✓ PACi NX only <sup>2)</sup>
Outdoor unit settings (remote controller connected to indoor unit)	✓ PACi NX only <sup>2)</sup>	✓ PACi NX only <sup>2)</sup>	✓ PACi NX only <sup>2)</sup>

1) Compatible with U-71/100/125/140PZH3E5/8 and U-100/125/140PZ3E5/8. 2) When connected to PACi NX indoor and outdoor unit combination.

## Function comparison

This shows the functions provided:		Remote controller functionalities	Panasonic H&C Control App	Panasonic Comfort Cloud App			
a) by the remote controllers							
b) by the apps							
		CZ-RTC5B	CZ-RTC6W / CZ-RTC6	CZ-RTC6WBL(W) / CZ-RTC6BL(W) + app	CZ-CAPWFC2 + app	CZ-RTC6WBLW2 / CZ-RTC6BLW2 + app	
<b>Basic operation</b>	ON / OFF, mode, temperature, air flow volume, air flow direction	✓	✓	✓	✓	✓	
<b>Timer functions</b>	Time display	✓	—	✓	✓	✓	
	Easy ON / OFF timer	✓	—	✓	—	—	
	Weekly program timer	✓	—	✓	✓	✓	
<b>Energy saving</b>	Outing function	✓	✓	✓	—	—	
	Temperature auto return	✓	—	✓	—	—	
	Temperature setting range limitation	✓	—	✓	✓	✓	
	OFF reminder	✓	—	✓	—	—	
	Energy saving mode	✓	—	✓	—	—	
	Schedule demand control	✓	—	✓	—	—	
	Energy monitoring	✓	—	✓	✓	✓	
	Econavi	✓	✓	✓	✓	✓	
	<b>Maintenance</b>	System failure information (alarm history)	✓	✓	✓	—	—
		Alarm display	✓	✓	✓	✓	✓
Service contact registration		✓	—	✓	—	—	
Filter sign		✓	✓	✓	—	—	
Test run		✓	✓	✓	—	—	
Sensor value monitor		✓	✓	✓	—	—	
Simple setting mode		✓	✓	✓	—	—	
<b>Others</b>	Detailed setting mode	✓	✓	✓	—	—	
	Key lock	✓	✓	✓	—	—	
	Ventilation fan control	✓	—	✓	—	—	
	Display contrast adjustment	✓	✓	✓	—	—	
	Rotation	✓	—	✓	—	—	
	Quiet operation mode	✓	—	✓	—	—	
	nanoe™ X	✓	✓	✓	✓	✓	

## Remote controller with Econavi

Easy to use, attractive, clear design, with demand control functions and energy consumption display! This useful feature makes this remote controller unique!



### 1 Design

The CZ-RTC5B wired remote controller is ideal for integration into the most demanding interior architectures.

The touch panel features a very sleek and easy to use display, which with its compact display is only 120 x 120 x 16 mm.

### 3 Display of information

The information is mainly based on pictograms to ensure easy understanding. The minimal amount of text is available in 6 languages (English / German / French / Spanish / Italian / Polish).

The screen is back lit to enable reading even during the night.

### 2 Key functions

- Easy setup of the timer and settings of the indoor unit
- Energy consumption display (for all PACi NX)
- Limitation of the energy consumption (Demand control) by timer.

### 4 Easy access to the menus

With the pictograms, the navigation, the selection and the settings are simple and easy to follow.

### Basic function (operation display and indication).

REFER TO PAGE 456 FOR MORE DETAILS

All functions are easily available on the remote controller.

- ON / OFF timer
- Weekly timer
- Quiet operation
- Remote controller sensor
- Operation prohibit
- Filter sign
- Energy saving
- Centralized control indication
- Mode change prohibit
- Automatic temperature return
- Temperature range limitation
- OFF remind
- Schedule demand control
- Ventilation
- Out Function

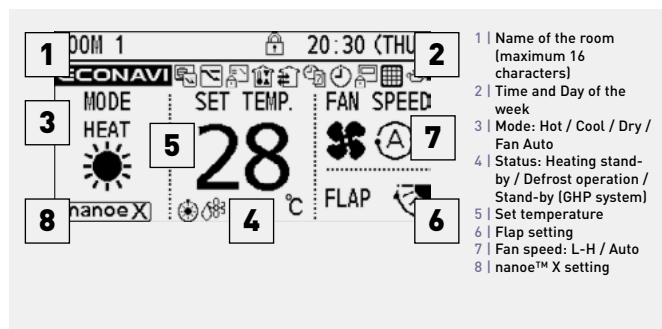

### Easy operation and quick access to all menus

- 1 | Set temperature will be selected, when any arrow button is touched
- 2 | Select the item (Mode or Fan speed) by left/right ◀▶ key
- 3 | Change the setting by up/down ▲▼ key

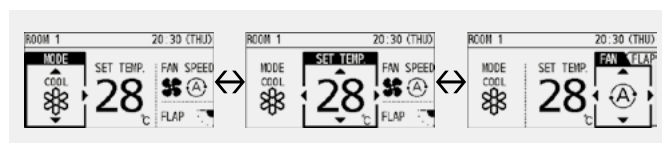

### Example of easy access to the functions: air direction setting

- 1 | Select "Air direction" and press "Enter" key
- 2 | Select the unit number by up/down ▲▼ key
- 3 | Select the flap position by up/down ▲▼ key
- 4 | Press "Return" key to go back the Menu display

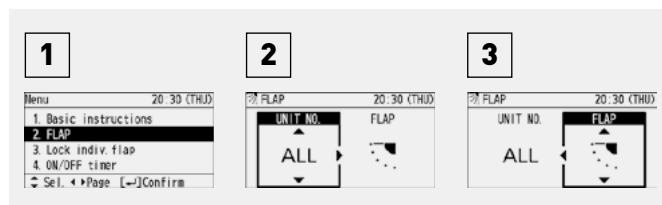

### Backup control by using CZ-RTC5B

Group wiring of 2 systems of PACi NX can do auto individual control: Rotation operation, backup operation and support operation.

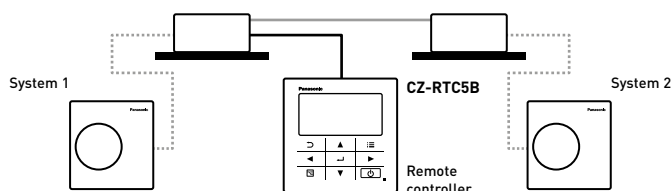

### Functions available on the CZ-RTC5B

Control item	Controllability	Indoor units	
		PACi NX	VRF
Basic operation	Operation, Mode, Temperature setting, Air flow volume, Air flow direction	✓	✓
Timer function	Time display	✓	✓
	Easy ON / OFF timer	✓	✓
	Weekly program timer	✓	✓
Energy saving	Outing function	✓	✓
	Temperature auto return	✓	✓
	Temperature setting range limitation	✓	✓
	OFF remind	✓	✓
	Energy saving mode	✓	✓
Others	Schedule demand control	✓	✓
	Energy monitoring - R32	✓	—

Control item	Controllability	Indoor units	
		PACi NX	VRF
Maintenance	System failure information	✓	✓
	Service contact registration	✓	✓
Others	Filter sign (rest time display) and reset	✓	✓
	Auto-address, Test run	✓	✓
	Sensor value monitor	✓	✓
Others	Simple / Detail setting mode	✓	✓
	Key lock	✓	✓
	Ventilation fan control	✓	✓
	Display contrast adjustment	✓	✓
	Remote controller sensor	✓	✓
Others	Quiet operation mode	✓	—
	Prohibit setting control from central controller	✓	✓

\* All specifications subject to change without notice.

# Intelligent controller

This controller is the smart solution for your advanced requirement in buildings.



+ REFER TO PAGE 460 FOR MORE DETAILS

**Intuitive operation.**

The screens used for operations all follow a common pattern, with the screens being easy to read and easy to use.

- Enlarged screen (10,4 inch) with colour LCD
- Smartphone-like gestures (flick, swipe, touch)

**Large screen display. Enlarged by 60%.**



**Easy swipe or flick operation.**



**Swipe.**  
This is an operation where the finger is slid in a direction (up or down) on the touch panel. This is used to scroll slowly.

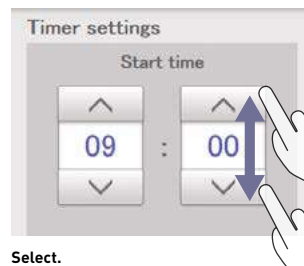

**Select.**  
This is an up and down movement of the finger touching the screen, used to pick settings in elements such as spin boxes.

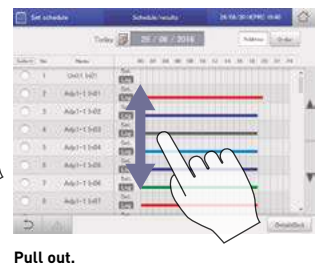

**Pull out.**  
This is an operation where the finger on the touch panel is flicked in a direction (up or down). This is used to scroll quickly.

**Enhanced functions for energy saving as standards**

- Set temperature auto return settings, Auto shut OFF, set temperature range limit settings
- Demand control function

**Screen of set temperature auto return setting.**

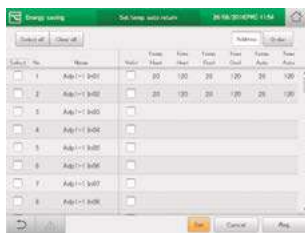

**Auto shut OFF.**



**Screen of outdoor demand control.**



- Outdoor demand input and timer settings possible
- Indoor can be set at  $\pm 1\text{ }^\circ\text{C}/\pm 2\text{ }^\circ\text{C}$  or thermostat OFF
- Indoor units controlled in sequence at 10-minute intervals

**Energy visualization**

- Energy saving plans are supported with graph display function
- Displays electricity and gas usage distribution

**Screen of graph display.**



Useful parameters are shown for your better energy saving. Ex.) Bar graph:

Indoor unit: Total operating time, thermostat ON operation time (Min.)  
Amount used (electricity, gas)  
Electricity or gas charges

Outdoor unit: Outdoor unit operation cycles (# cycles)  
Engine time in operation (Hrs.)  
Cumulative Inverter power output  
Cumulative PV power output

Pulse value selection per different data intervals 1 hour/1 day/ 1 month compared with last year.

**Main function**

Gesture function (flick, swipe, touch)	✓
Graph display (trends, comparisons)	✓
Web functions (maximum 64 users)	✓
Recipient setting for warning email	✓ (Maximum 8)
Automatic return to setting temperature	✓
Limitation of setting temperature range	✓
Left-on prevention	✓
Quiet operation of outdoor unit	✓
Occupant sensor linkage	✓
Demand function	✓
Charge calculation	✓
Log display	✓ Warning 10000 items. Status change 50000 items
Linked control (event definition 50 events, input: 32, output: 32)	✓
Under maintenance (under inspection registration)	✓

## Econavi sensor

The Econavi sensor detects presence in the room, and quietly adapts the PACi NX or VRF air conditioning system in order to improve comfort and energy savings.





- Detects human activity and adjusts temperature by 2 degrees (up or down) to optimise comfort and efficiency
- If there is no activity detected for a set time period, the Econavi will stop the unit or move to a temperature previously set
- The Econavi device is installed independently of the indoor unit, and is located in the area best suited for detection

### Applications

**Saving energy for offices:** If the air conditioning is left on after the last employee leaves the office, Econavi will automatically react, reducing or stopping the system.

**Increased comfort in hotel rooms:** When presence is detected in the room, the temperature is automatically adjusted to achieve best comfort.

### Key points

- Compatible with cassette, wall-mounted, hide-away and Ceiling units
- Improves efficiency
- Better comfort
- Can be installed in the best location within the room for detection purposes

### Sensor location image.

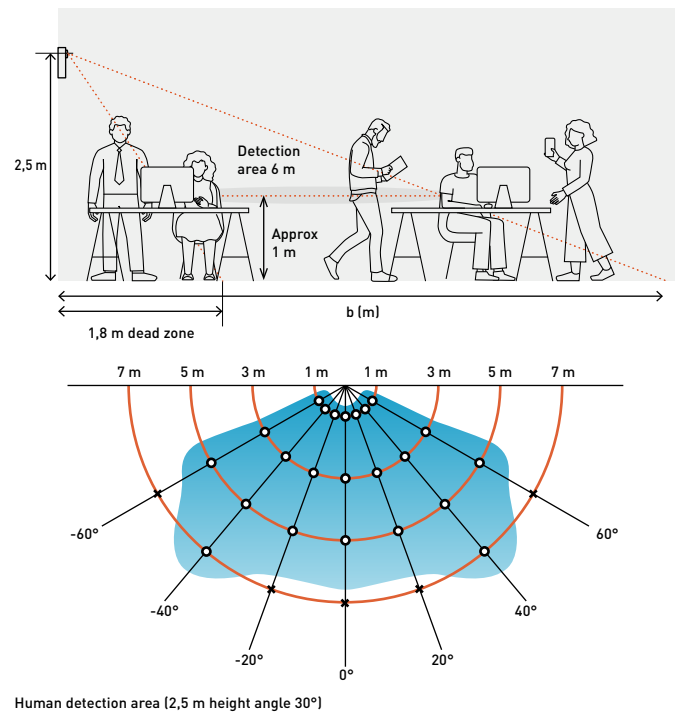

Providing outstanding energy saving performance, Panasonic's Inverter system can be connected to Econavi to detect when energy is being wasted. Econavi senses the presence or absence of people and the level of activity in each area of an office. When unnecessary heating or cooling is detected, indoor units are individually controlled to match office conditions for energy saving operation.

### Detection of the level of activity enables precise power saving.

Presence or absence of people at their desks and the level of activity in the office are detected in real time. Set temperature is automatically adjusted to optimise the lower power consumption.

### Remote Econavi sensor allows optimum energy operation.

Pillars, walls, cabinets and other fittings obstruct the sensor, reducing the area of detection and lowering the energy saving effect. Taking into consideration blind spots, Panasonic enables the optimum layout for sensors in any office.



Econavi sensor: CZ-CENSC1

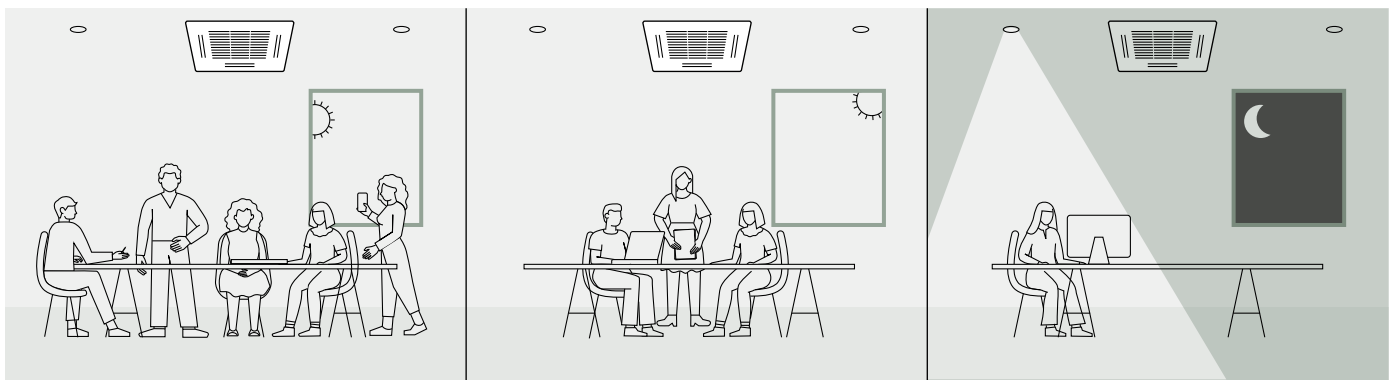

**In the morning.**  
Thorough cooling when there is a high level of activity.

**In the afternoon.**  
Reduced cooling when there are fewer people.

**At night.**  
Automatic Thermo OFF depending on conditions at the end of the day.

# Controller for hotel application

Innovative line up of room controllers specially designed for hotel applications. With a modern cosmetic that match room interiors and simple operation for hotel guests.



**3** Room card switch (field supply).

**Controller to integrate all room hotel needs in one device.**  
Card switch. Heating and cooling control. Light control. Window control. Possible to connect to Modbus.



Lighting control.



Wall silent motion sensor  
PAW-WMS-AC (-DC).



Indoor unit. Variable static  
pressure hide-away.



Door or window contact  
PAW-DWC.



Ceiling silent motion sensor  
PAW-CMS-AC (-DC).

[+ REFER TO PAGE 457 FOR MORE DETAILS](#)

- Easy to install
- Cost effective installation as all electrical cables are centralized on the remote: The lighting, card contact, motion detector, window contact and the air conditioning are controlled
- Architect inspired attractive design with 2 colors: black or white
- Stand alone and Modbus
- Bespoke finish by special order

**Energy saving functions included on the device.**

Turns OFF air conditioning and lighting when room is unoccupied. Disables air conditioning when window is open. Configurable maximum/minimum setpoint temperature.

**Easy remote controller.**

The hotel guest will have access to limited functions to control the air conditioning: ON / OFF, Temperature and Fan speed.

**Easy set up.**

Stand alone model with easy configuration menu to access all parameters. A pre-define scenario can be uploaded on the remote controller connected to a computer to make installation on site Plug & Play (only on the Modbus models).

**NFC fast set up.**

With the touch display control and touch room controller setting are quicker than ever. Just touching smartphone with NFC capability the settings will be saved. This function is also possible even when the control is not wired. Giving flexibility to save the setting even before installation.

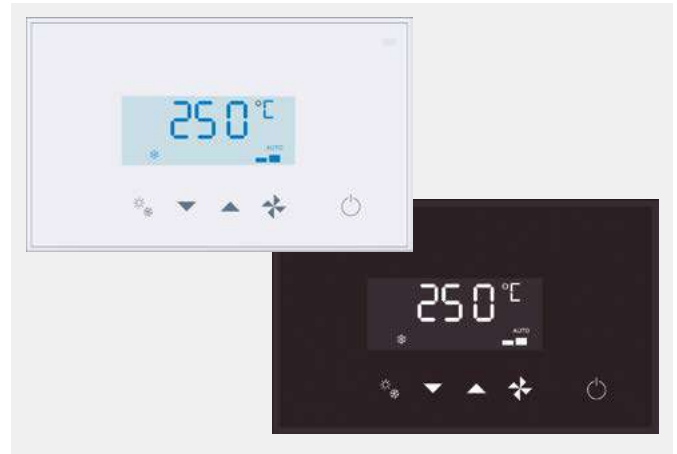

Type	Model	Colors	Digital inputs	Digital output	BMS	Inst. set up	T. sensor
Touch display controller	PAW-RE2D4-WH	White	2			NFC	Built-in
	PAW-RE2D4-BK	Black	2			NFC	Built-in
Touch room controller	PAW-RE2C4-MOD-WH	White	4	4	Modbus	NFC	Built-in
	PAW-RE2C4-MOD-BK	Black	4	4	Modbus	NFC	Built-in

**Room controller: 4 digital inputs and 4 digital output**

Room controller offers flexibility and easy installation thanks to 4 preconfigured options. This is available in Modbus type. Modbus references: PAW-RE2C4-MOD-WH, PAW-RE2C4-MOD-BK.

Wiring configuration example for option 2 in Modbus type.

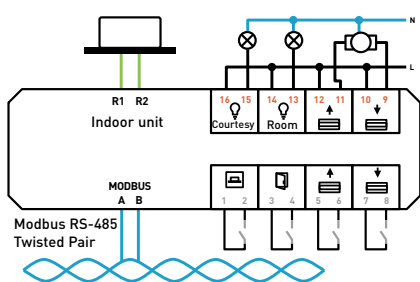

Configurations	4 options available I/O configurations: Inputs				Available I/O Configurations: Outputs			
	Digital 1-2	Digital 3-4	Digital 5-6	Analog 7-8	Relay 15-16	Relay 13-14	Relay 11-12	Relay 9-10
Option 1	Card	Window	Lighting	Temperature	Courtesy	Lighting	Not used	Valve actuator
Option 2	Card	Window	Blinds up	Blinds down	Courtesy	Lighting	Blinds up	Blinds down
Option 3	Motion sensor	Window	Door contact	Temperature	Courtesy	Lighting	Not used	Valve actuator
Option 4	Lighting	Window	Blinds up	Blinds down	Not used	Lighting	Blinds up	Blinds down

**Display: 2 digital inputs**

Display control allows to handle 2 inputs to perform most common operation in room hotels. References: PAW-RE2D4-WH, PAW-RE2D4-BK.

Wiring example for display controller.

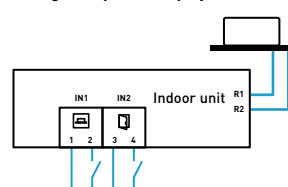

Configurations	3 options available: Inputs	
	IN1 [1-2]	IN2 [3-4]
Option 1	Card	Window
Option 2	Motion sensor	Window
Option 3	Motion sensor	Door contact

Hotel room controller	
PAW-RE2C4-MOD-WH	Modbus RS-485 touch room controller with I/O, white
PAW-RE2C4-MOD-BK	Modbus RS-485 touch room controller with I/O, black
PAW-RE2D4-WH	Touch display control with 2 digital inputs, white
PAW-RE2D4-BK	Touch display control with 2 digital inputs, black

Accessories sensors	
PAW-WMS-DC	Wall silent motion sensor 24 V
PAW-WMS-AC	Wall silent motion sensor 240 V AC
PAW-CMS-DC	Ceiling silent motion sensor 24 V
PAW-CMS-AC	Ceiling silent motion sensor 240 V AC
PAW-24DC	Power supply 24 V
PAW-DWC	Door or window contact

## A united BMS interface with S-Link

Introducing a unified BMS interface, compatible with Modbus, BACnet, and KNX protocols. PAW-AC2-BMS-16, 64, 128.

BMS interface with Panasonic communication bus helps you to get significant savings.

Easy to use and reliable interfaces for a straightforward integration.



Modbus®

Home  
automation

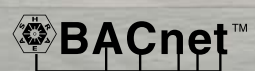

### 1 Direct connection to S-Link communication bus

The interface can provide faster, cheaper, easier solution in your projects!

- No need for additional gateway (CZ-CFUNC2)
- Significant 50% cost saving for BMS interface\*
- Avoid mistakes and reduce configuration time

\* In the case of PAW-AC2-BMS-16 by Panasonic calculation.  
 \*\* One BMS protocol is available per one interface.

System example with the unified BMS interface.

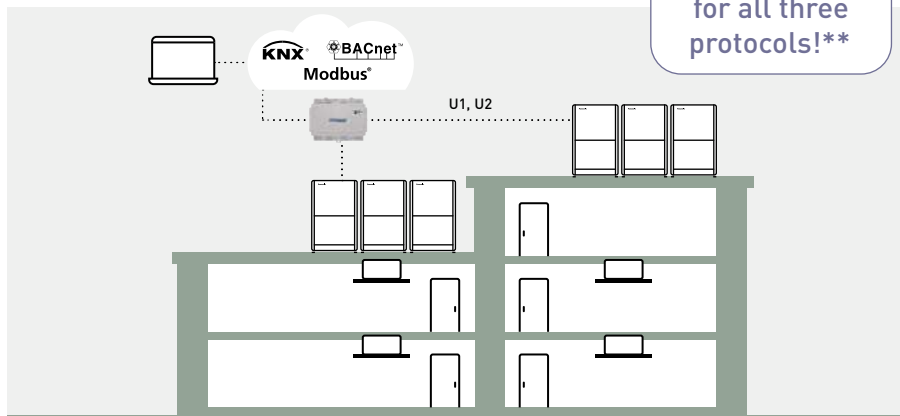

U1U2 link is connected directly to IntesisBox. Support from 16 to 128 per each interface.

### 2 Easy configuration

- A single device supporting all Modbus, BACnet, and KNX protocols
- Dedicated configuration support tool (MAPs for Panasonic)
- Firmware updates with improvements and features
- Scan: Automatic identification of the units present in the VRF system

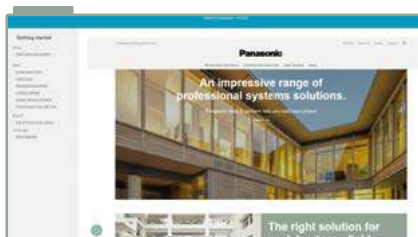

Screen examples of MAPs for Panasonic.

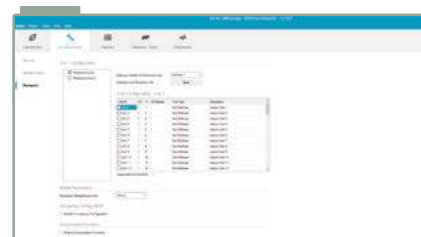

### 3 Upgraded specifications

- Electricity consumption calculation using three inputs from pulse meters or Modbus meters
- BACnet: Version 14 and BTL Certified
- Modbus and BACnet 128 units now supports IP and RTU/MSTP

#### Home automation compatibility for Smart Home systems for PAW-AC2-BMS-\*\*

##### Drivers available for:

- AMX
- Control4
- eedomus
- Elan
- Fibaro
- iRidium
- Eedom
- RTI
- Savant
- Creston
- Kuju
- Vera



<b>PAW-AC2-BMS-16</b>	A unified interface supporting Modbus, BACnet, and KNX protocols for up to 16 indoor units
<b>PAW-AC2-BMS-64</b>	A unified interface supporting Modbus, BACnet, and KNX protocols for up to 64 indoor units
<b>PAW-AC2-BMS-128</b>	A unified interface supporting Modbus, BACnet, and KNX protocols for up to 128 indoor units

Version	Connectable indoor units	Connectable outdoor units	Number of S-Link communication bus port
<b>16</b>	1-16	1-16	1
<b>64</b>	1-64	1-30	1
<b>128</b>	128 [1-64 / S-Link communication bus port]	60 [1-30 / S-Link communication bus port]	2

# Control and connectivity

A wide variety of control options to meet the requirements of different applications.

## Centralized control systems

### Centralised control.



**P-AIMS core software.**  
Up to 1024 indoor units.  
CZ-CSWKC2

### Intelligent controller.



**Intelligent controller.**  
Up to 256 indoor units touch screen with web server.  
CZ-256ESMC3

### Panasonic AC Smart Cloud.



**Cloud internet control.**  
Up to 128 groups. Controls 128 units.  
CZ-CFUSCC1

### Connection with general equipment.



**ON / OFF control for external devices such as ERV.**  
Controls 1 unit.  
CZ-CAPC3



**Demand control for Mini ECOi (LZ2, LE2).**  
Up to 4 outdoor units.  
CZ-CAPDC3



**Mini Seri-Para I/O Unit 0 - 10 V.**  
Controls 1 indoor unit or a group of 8 indoor units.  
CZ-CAPBC2



**Communication Adaptor.**  
Up to 128 groups. Controls 128 units.  
CZ-CFUNC2

## Domestic integration to S-Link

### CZ-CAPRA1

Can connect RAC range to S-Link. Full control is now possible.

#### Integrates any unit in big system control.

- YKEA server room integration <sup>1)</sup>
- Small offices with domestic indoors
- Tender for refurbishment (old system Domestic and VRF in one installation)
- Centralized Control Systems: 64 indoor units
- Intelligent controller / Web Server: 256 indoor units
- Panasonic AC Smart Cloud

- Basic operation items: ON / OFF, Mode select, Temperature setting, Fan speed, Flap setting, Remote control prohibit
- External input: ON / OFF control signal, Abnormal stop signal
- External output for Relay <sup>2)</sup>: Operation status (ON / OFF), Alarm status output

1) When duty rotation using the remote controller is set up, CZ-CAPRA1 cannot be connected.  
2) Because current CN-CNT connector can not provide the power for external output relay, additional 12 V DC power supply for external relay is necessary.

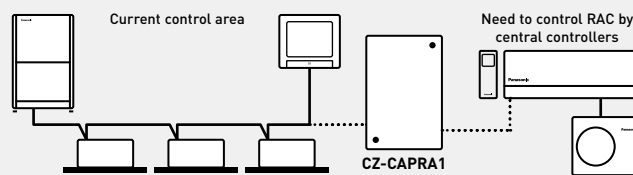

Current system for PACi / VRF. Central controller can connect to S-Link line to control units directly.

RAC units cannot connect directly to S-Link to be managed by Central Controllers.







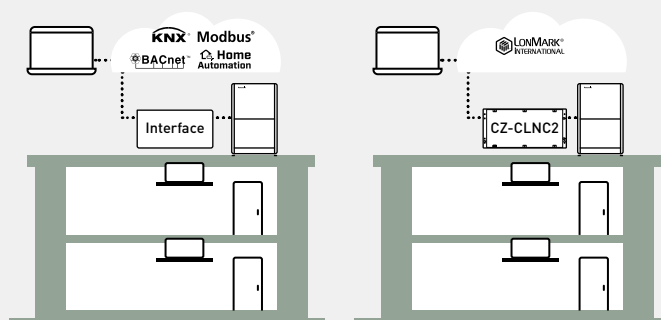

It's necessary to have interface between S-Link and RAC protocol to cover basic operating items.

## Easy connection to KNX, Modbus, Lonworks, BACnet and Proprietary Home Automation Systems

Easy and reliable solution to integrate your Panasonic heating and cooling systems into any BMS or BEMS. Fully bi-directional communications with all necessary parameters.

For more information, contact Panasonic.



			Econavi control	Built-in thermostat	Indoor units which can be controlled	Use limitations	Function ON / OFF	Mode setting	Fan speed setting	Temperature setting	Air flow direction	Permit/Prohibit switching	Weekly program	BMS protocol
<b>Individual controllers</b>														
CONEX Wired remote controller		CZ-RTC6W CZ-RTC6 Non-wireless	✓	✓	1 group, 8 units	· Up to 2 controllers can be connected per group	✓	✓	✓	✓	✓	—	—	—
		CZ-RTC6WBL CZ-RTC6BL With Bluetooth®	✓	✓	1 group, 8 units	· Up to 1 controller can be connected per group	✓	✓	✓	✓	✓	—	✓	—
		CZ-RTC6WBLW2 CZ-RTC6BLW2 With Wi-Fi and Bluetooth®	✓	✓	1 group, 8 units	· Up to 1 controller can be connected per group	✓	✓	✓	✓	✓	—	✓	—
Design wired remote controller		CZ-RTC5B	✓	✓	1 group, 8 units	· Up to 2 controllers can be connected per group	✓	✓	✓	✓	✓	—	✓	—
Touch room controller for hotel with Dry Contact and Modbus		PAW-RE2C4-MOD-WH PAW-RE2C4-MOD-BK  WH: White, BK: Black. Bespoke finish available on request.	—	✓	1 indoor unit	—	✓	✓	✓	✓	—	✓	—	Modbus + 4 digital I/O signals
Touch display control for hotel with Dry Contacts		PAW-RE2D4-WH PAW-RE2D4-BK  WH: White, BK: Black. Bespoke finish available on request.	—	✓	1 indoor unit	—	✓	✓	✓	✓	—	✓	—	Stand Alone + 2 digital inputs
Infrared remote controller		CZ-RWS3 + CZ-RWRU3 CZ-RWS3 + CZ-RWRY3 CZ-RWS3 CZ-RWS3 + CZ-RWRL3 CZ-RWS3 + CZ-RWRD3 CZ-RWS3 + CZ-RWRT3 CZ-RWS3 + CZ-RWRC3	✓	—	1 group, 8 units	· Up to 2 controllers can be connected per group	✓	✓	✓	✓	✓ <sup>1)</sup>	—	—	—
<b>Centralized controllers</b>														
System controller with weekly timer		CZ-64ESMC3	✓	—	64 groups, maximum 64 units	· Up to 10 controllers, can be connected to one system · Main unit/sub unit (1 main unit + 1 sub unit) connection is possible · Use without remote controller is possible	✓	✓	✓	✓	✓ <sup>1)</sup>	✓	✓	—
Central ON / OFF controller		CZ-ANC3	—	—	16 groups, maximum 64 units	· Up to 8 controllers (4 main units + 4 sub units) can be connected to one system · Use without remote controller is impossible	✓	—	—	—	—	✓	—	—
Intelligent controller (touch screen/web server)		CZ-256ESMC3	✓	—	Main unit: 128. Up to 256 units can be expanded	· Communication adaptor CZ-CFUNC2 is necessary for connection with more than 128 units	✓	✓	✓	✓	✓ <sup>1)</sup>	✓	✓	—

1. Setting is not possible when a remote controller unit is present (use the remote controller for setting). \* All specifications subject to change without notice.

# Individual controllers wired

## CONEX wired remote controller

### CZ-RTC6W // CZ-RTC6 // CZ-RTC6WBL // CZ-RTC6BL // CZ-RTC6WBLW2 // CZ-RTC6BLW2 <sup>1)</sup>

- 3 line-up: - CZ-RTC6W // CZ-RTC6: Non-wireless
  - CZ-RTC6WBL // CZ-RTC6BL: Bluetooth®
  - CZ-RTC6WBLW2 // CZ-RTC6BLW2: Wi-Fi and Bluetooth®
- Colours: 6W: White. 6: Black
- Intuitive control with stylish design profile
- Clean face with full flat and LCD display
- Dimension (HxWxD): 86 x 86 x 25 mm

### Panasonic H&C Control App <sup>2)</sup>

- Daily remote control operation via Bluetooth®
- Quick and easy App set-up for system setting

### Panasonic H&C Diagnosis App <sup>3)</sup>

- Easy access to service parameters and service checker data via Bluetooth®

### Panasonic Comfort Cloud App

- Especially designed for end users
- Remote operation via Wi-Fi

### Basic operation.

- Mode setting: Heat / Cool / Dry / Fan / Auto
- Temperature setting
- Fan speed: 5 levels
- Air flow direction
- nanoe™ X and Econavi setting
- Weekly program <sup>4)</sup>

1) Compatible with PACi NX Series.

2) CZ-RTC6WBL, CZ-RTC6BL, CZ-RTC6WBLW2 or CZ-RTC6BLW2 required.

3) A service checker interface is required. Compatible with PACi NX Series.

4) Can be set from Panasonic H&C Control App.



## Design wired remote controller

### CZ-RTC5B

- Power consumption monitor (only for PACi NX)
- Flat face design and touch sensor switch for stylish design and operating usability
- Functions such as for energy saving and monitoring and for service use are available on the full dot LCD (3,5" display)
- Improved illumination
- White LED backlit
- Blink when alarm occurs

\* Panasonic App is required on your smartphone.

### Basic Operation.

- Operation
- Mode
- Temperature setting
- Air flow volume
- Air flow direction

### Timer function.

- Outing function
- Weekly program timer
- Easy ON / OFF timer
- Time display

### Energy saving.

- Outing function
- Temperature setting range limitation
- Temperature auto return
- OFF remind
- Schedule demand control
- Energy saving mode
- Energy monitoring

### Others.

- Key lock
- Ventilation fan control
- Display contrast adjustment
- Remote controller sensor
- Quiet operation mode
- Prohibit setting control from central controller
- Rotation / backup control

\* Rotation and backup control with CZ-RTC5B is available for all PACi NX systems.





## Room controller for hotel rooms

### PAW-RE2C4-MOD-WH // PAW-RE2C4-MOD-BK

- Easy to install
- Cost effective installation as all electrical cables are centralised on this remote
- Architect inspired attractive design
- Direct connection to the Indoor unit with all primary functions of indoor unit available
- 2 options available: Stand alone and Modbus communication
- Colours: WH: White. BK: Black
- Room controller: 4 digital inputs and 4 digital outputs

#### From this remote controller.

The lighting, card contact, motion detector, window contact and the air conditioning are controlled.

#### Energy saving functions included on the device.

- Turns OFF air conditioning and lighting when room is unoccupied
- Disables air conditioning when window is open
- Maximum/minimum setpoint temperature configurable

#### Fast and simple set up.

Set up is simple and easy for room controllers. It is extremely easy and quick with touch models, which can be set up by using smartphone with NFC technology, even when control is not yet installed / powered.



## Display control for hotel rooms

### PAW-RE2D4-WH // PAW-RE2D4-BK

- Easy to install
- Cost effective installation as all electrical cables are centralised on this remote
- Architect inspired attractive design
- Direct connection to the Indoor unit with all primary functions of indoor unit available
- Stand alone communication
- Colours: WH: White. BK: Black
- Basic hotel function: 2 digital inputs

#### From this remote controller.

The card contact, motion detector, window contact and the air conditioning are controlled.

#### Energy saving functions included on the device.

- Disables air conditioning when window is open
- Maximum/minimum setpoint temperature configurable

#### Fast and simple set up.

Set up with smartphone with NFC technology, even when control is not yet installed/powered.



# Individual wireless controllers

## Infrared remote controller

**CZ-RWS3 + CZ-RWRU3 // CZ-RWS3 + CZ-RWRY3 // CZ-RWS3 // CZ-RWS3 + CZ-RWRL3 // CZ-RWS3 + CZ-RWRD3 // CZ-RWS3 + CZ-RWRT3 // CZ-RWS3 + CZ-RWRC3**

- Easy installation for the 4 Way Cassette type by simply replacing the corner part
- 24 hour timer function
- Remote controller by main remote controller and sub controller is possible (maximum 2 remote controllers (main remote controller and sub controller) can be installed for one indoor unit)
- When CZ-RWS3 is used, infrared control becomes possible for all indoor units (1: when a separate receiver is set up in a different room, control from that room also becomes possible. 2: automatic operation by means of the emergency operation button is possible even when the remote controller has been lost or the batteries have been exhausted)
- Operation of separate energy recovery ventilators (when commercial ventilation fans or heat-exchange ventilation fans have been installed, they can be operated with this remote controller (interlocked operation with the indoor unit or independent ventilation ON / OFF))



Infrared remote controller and receiver for 4 way 90x90 cassette. CZ-RWS3 + CZ-RWRU3



Infrared remote controller and receiver for 4 Way 60x60 cassette PY3 (with a panel). CZ-RWS3 + CZ-RWRY3



Infrared remote controller for wall-mounted, 4 way 60x60 with panel and floor console. CZ-RWS3



Infrared remote controller and receiver for 2 way cassette. CZ-RWS3 + CZ-RWRL3



Infrared remote controller and receiver for 1 way cassette. CZ-RWS3 + CZ-RWRD3



Infrared remote controller and receiver for ceiling. CZ-RWS3 + CZ-RWRT3



Infrared remote controller and receiver for all indoor units. CZ-RWS3 + CZ-RWRC3



## Remote sensor

**CZ-CSRC3**

- This remote sensor can be connected to any PACi NX or VRF unit. Use it to detect the room temperature when no remote controller sensor or body sensor is used (connection to a system without a remote controller is possible)
- For joint use with a remote controller switch, use the remote controller switch as main remote controller
- Batch group control for up to 8 indoor units
- Appearance design based on simplified remote controller chassis
- Dimensions (HxWxD): 120 x 70 x 17 mm
- Weight: 70 g
- Temperature/Humidity range: 0 °C to 40 °C / 20% to 80% (no condensation) (indoor use only)
- Power supply: 16 V DC (supplied from indoor unit)
- Maximum number of connectable indoor units: Up to 8 units



Control contents	Part name, model No.	Quantity	
Standard control	<ul style="list-style-type: none"> <li>· Control of the various operations of the indoor unit by wired or infrared remote controller</li> <li>· Cooling or heating mode of the outdoor unit is decided by the first priority of the remote controller</li> <li>· Switching between remote controller sensor and body sensor is possible</li> </ul>	High spec wired remote controller: CZ-RTC5B CONEX wired remote controller: CZ-RTC6W // CZ-RTC6 // CZ-RTC6WBL // CZ-RTC6BL // CZ-RTC6WBLW2 // CZ-RTC6BLW2 Infrared remote controller: CZ-RWS3 + CZ-RWRU3 // CZ-RWS3 + CZ-RWRY3 // CZ-RWS3 // CZ-RWS3 + CZ-RWRL3 // CZ-RWS3 + CZ-RWRD3 // CZ-RWS3 + CZ-RWRT3 // CZ-RWS3 + CZ-RWRC3	1 unit each
[1] Group control	<ul style="list-style-type: none"> <li>· Up to 8 units can be connected to 1 remote controller</li> <li>· Operation of all indoor units in the same mode</li> </ul>	High spec wired remote controller: CZ-RTC5B CONEX wired remote controller: CZ-RTC6W // CZ-RTC6 // CZ-RTC6WBL // CZ-RTC6BL // CZ-RTC6WBLW2 // CZ-RTC6BLW2 Infrared remote controller: CZ-RWS3 + CZ-RWRU3 // CZ-RWS3 + CZ-RWRY3 // CZ-RWS3 // CZ-RWS3 + CZ-RWRL3 // CZ-RWS3 + CZ-RWRD3 // CZ-RWS3 + CZ-RWRT3 // CZ-RWS3 + CZ-RWRC3	8 units
[2] Main/sub remote controller	<ul style="list-style-type: none"> <li>· Maximum 2 remote controllers per indoor unit</li> <li>· The button pressed last has priority</li> <li>· Timer setting is possible even with the sub remote controller</li> </ul>	Main or sub.: High spec wired remote controller: CZ-RTC5B CONEX wired remote controller: CZ-RTC6W // CZ-RTC6 // CZ-RTC6WBL // CZ-RTC6BL // CZ-RTC6WBLW2 // CZ-RTC6BLW2 Infrared remote controller: CZ-RWS3 + CZ-RWRU3 // CZ-RWS3 + CZ-RWRY3 // CZ-RWS3 // CZ-RWS3 + CZ-RWRL3 // CZ-RWS3 + CZ-RWRD3 // CZ-RWS3 + CZ-RWRT3 // CZ-RWS3 + CZ-RWRC3	As required

# Centralised controllers

## System controller with schedule timer

### CZ-64ESMC3

**Operation with various functions from central station.**

**Panasonic unveils state-of-the-art digital controller.**

Panasonic's innovative and easy to use interface that offers full functionality with an integrated schedule timer and system controller, making managing heating and cooling systems easier than ever before. The CZ-64ESMC3 includes Panasonic's popular schedule timer, which gives users full flexibility over when they want their property heated or cooled. Users can adjust the system for holidays, pausing operations for long periods of time so that energy isn't wasted heating or cooling an empty home or office. The controller also allows six operations per day to be programmed.

### Mix of current 2 controllers: System controller + schedule timer.

System controller will be designed by taking priority on these 2 operations with following technical key points:

- Same operation feeling as wired remote controller by touch-key panel
- High visibility and usability by full-dot LCD
- Based on high wired remote controller
- Maximum 64 group of indoor units, individual control for 64 units
- 4 zone control; 1 zone = maximum 16 groups
- Several energy saving function (based on CZ-RTC5B)
- 6 timer program per day for 1 week (7 days) operation (total 6 x 7 = 42 programs)
- Basic setting items (Temperature, Mode, Fan speed, Flap position) can be set by same manner as CZ-RTC5B

### Function list:

Central control functions:

- Central control / individual setting
  - Start-stop prohibition for remote controller
  - Start-stop / Mode change / Temperature setting prohibition for remote controller
  - Mode change / Temperature setting prohibition for remote controller
  - Mode change prohibition for remote controller
  - Select items for prohibition
- Filter information
  - Filter sign
  - Filter sign reset
- Ventilation setting

Timer functions and external I/O:

- Weekly timer
  - Timer setting enable / disable
  - Copy of timer setting
- Maintenance
  - External signal (Start / Stop) (Demand control)
  - Centralized control master-slave setting
  - Alarm history
- Initial setting
  - Clock

Energy saving, maintenance and operating functions:

- Energy saving control
  - Econavi ON / OFF
- Filter information
  - Filter sign and hour counter display
- Maintenance
  - Service contact
- Initial setting
  - Clock display setting
  - Name Setting
  - Operation lock setting
  - Operation sound setting
  - LCD contrast setting
  - LCD backlight setting
  - Select displayed language (EN/FR/IT/ES/DE)
  - Administrator password
- Setting information list



**ECONAVI**

Sample display image /  
Operation status display

Operation Status ALL



Operation Status ZONE



Operation Status GROUP



## ON / OFF controller

### CZ-ANC3

**Only ON / OFF operation from central station.**

- 16 groups of indoor units can be controlled
- Collective control and individual group (unit) control can also be performed
- Up to 8 ON / OFF controller (4 main, 4 sub) can be installed in one link system
- The operation status can be determined immediately
- Dimensions (H x W x D): 121 x 122 x 14 + 52 mm (embedding dimension)

Power supply: 220 to 240 V AC.

I/O part: Remote input (effective voltage: within 24 V DC): ALL ON / OFF.

Remote output (allowable voltage: within 30 V DC): ON, Alarm.

Note: As operation mode and temperature settings are not possible with the ON / OFF controller, it must be used together with a remote controller, a system controller etc.

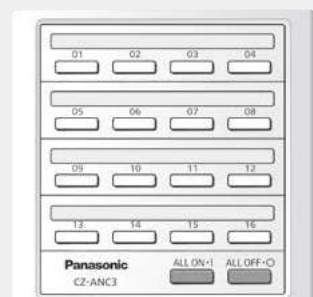

# Centralised controllers

## Intelligent controller (touch screen panel)

### CZ-256ESMC3

#### Simplified load distribution ratio (LDR) for each tenant.

- Dimensions (HxWxD): 240 x 280 x 20 (+60) mm
- Power supply: Single phase 100-240 V ~ 50/60 Hz
- Maximum number of connectable indoor units: 256 units (maximum per link: 64 units)
- Maximum number of connectable outdoor units: 120 units (maximum per link: 30 units)
- Central control device: Up to 10 units
- Enlarged display screen: 10,4 inch touch-panel colour LCD. Pursuing visibility, ease of use. Retrieve data from USB memory: Place the USB port inside the panel (USB memory available in stores)
- Communication adaptor: CZ-CFUNC2\*

\* CZ-CFUNC2 is required to connect more than 128 indoor units.

#### Functions:

- Graph display (trends, comparisons)
- Econavi ON / OFF
- Outdoor unit quiet operation ON / OFF
- Energy saving functions: Set temperature auto return settings, Auto shut OFF, Set temperature range limit settings, Energy saving for PAC current value, etc.
- Event control (such as equipment linkage)
- Performs closing at end of any period

#### Operation and status.

You can check to operational status (ON / OFF, operating mode, alarms, etc.) of all indoor units and outdoor units in real time. You can also select indoor units to change their settings.

#### Operation scheduling.

You can register daily operation schedules (ON / OFF time, operating modes, set temperatures, etc.) for individual indoor units or groups of indoor units. Operations can be schedule for up to 2 years in advance.

#### Load distribution calculation for each tenant.

- Air-conditioner load distribution ratio is calculated for each unit (tenant) with used energy consumption data (m<sup>3</sup>, kWh)
- Calculated data is stored as a CSV type file
- Data from the last 365 days is stored

#### Web application. Web access and control from remote station.

- Accessing from remote PC
- You can monitor/operate system by using web browser



ECONAVI

#### Remote controller.

The LAN terminal on this unit enables you connect it to a network. Connecting to Internet will enable you to operate the unit and check the status using a PC from a remote location\*.

\* Remote access rights and additional IT infrastructure / programming may be required.

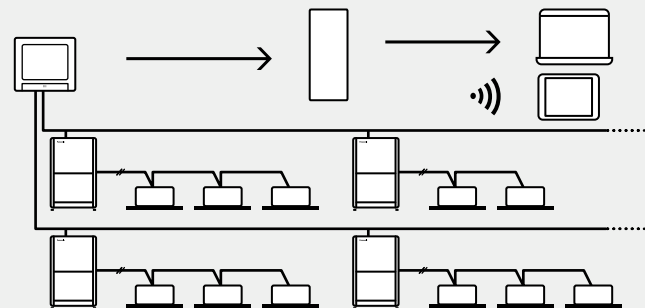

#### Backup tool to save your commissioning time.

Various data such as distribution, setting, log history etc. can be saved by CSV file.

Setting data of CSV file is available to edit and import to the controller again.

You can save time for commissioning and change setting flexibly and easily by your PC.

- Customize data
- Data recovery
- Data can be imported again by general USB.

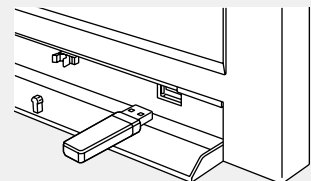

#### System configuration example.

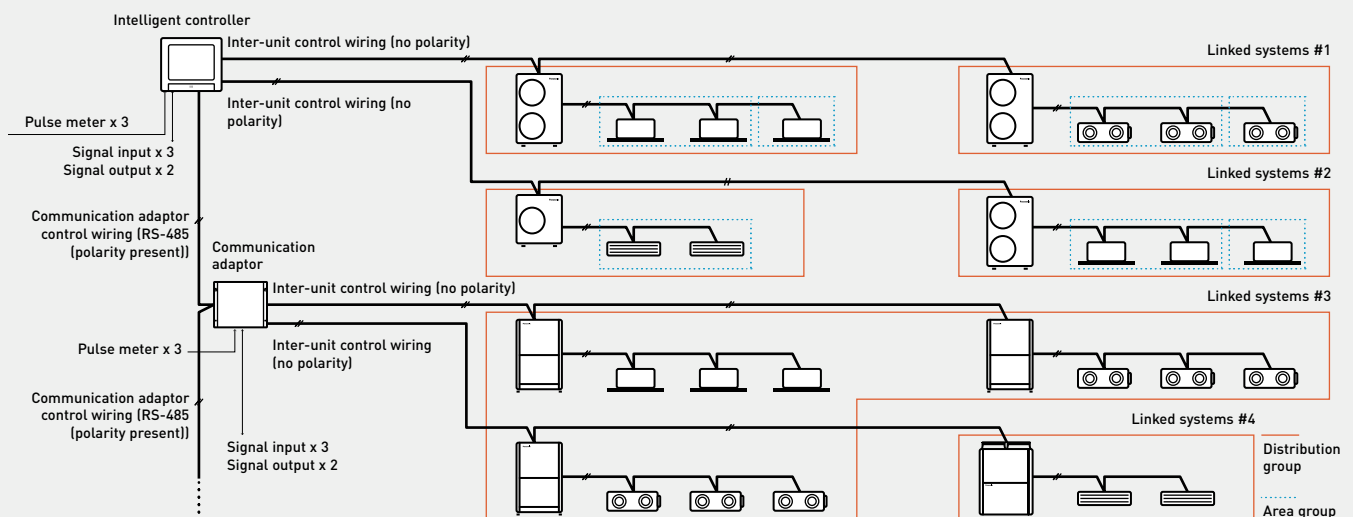

## P-AIMS core software

### CZ-CSWKC2 / P-AIMS core software.

Centralised software to control up to 1024 indoor units.

#### Functions of basic software.

- Standard remote controller for all indoor units.
- Many timer schedule programs can be set on the calendar.
- Detailed information display for alarms.
- CSV file output with alarm history, operating status.
- Automatic data backup to HDD.

P-AIMS is suitable for large shopping centers and universities with many areas/ buildings. 1 "P-AIMS" PC can have 4 independent systems at once.

Each system can have maximum 8 C/A units, and control maximum 512 units. In total, 1024 indoor units can be controlled by 1 "P-AIMS" PC.

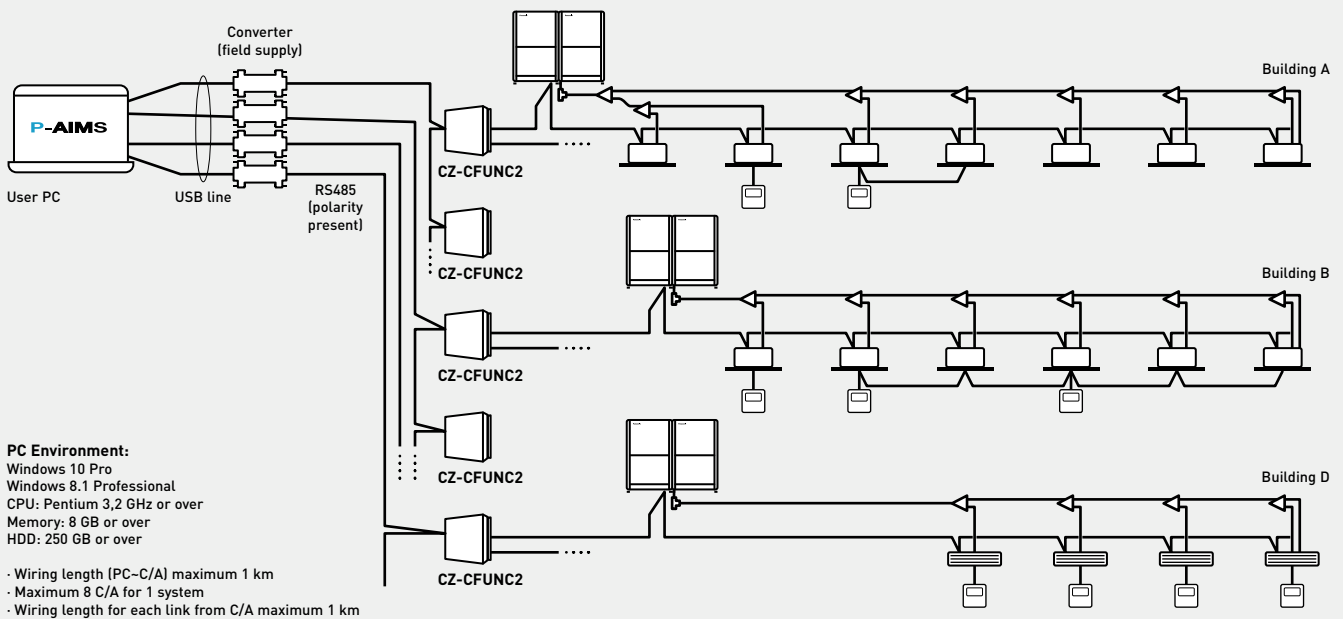

### P-AIMS optional software CZ-CSWAC2 / P-AIMS consumption calculation extension.

- Air-conditioner load distribution ratio is calculated for each unit (tenant) with used energy consumption data (m<sup>3</sup>, kWh)
- Calculated data is stored as a CSV type file
- Data from the last 365 days is stored

### P-AIMS optional software CZ-CSWWC2 / P-AIMS web application extension.

- Accessing P-AIMS software from remote PC
- You can monitor/operate ECOi System by using web browser (Internet Explorer)

### P-AIMS optional software CZ-CSWGC2 / P-AIMS layout display extension.

- Operating status monitor is available on the layout display
- Object's layout and indoor unit's location can be checked at once
- Each unit can be controlled by virtual remote controller on the display
- Maximum 4 layout screens are shown at once

### P-AIMS optional software CZ-CSWBC2 / P-AIMS BACnet extension.

- Can communicate with other equipment by BACnet protocol
- ECOi System can be controlled by both BMS and P-AIMS
- Maximum 255 indoor units can be connected to 1 PC (that has P-AIMS basic and BACnet software).



With 4 upgrade packages the basic software can be upgraded to suit individual requirements.

# Centralised controllers

## Local adaptor for ON / OFF control

### CZ-CAPC3

#### Connection with general equipment.

- Control and status monitoring is possible for individual indoor unit (or any external electrical device up to 250 V AC, 10 A) by contact signal

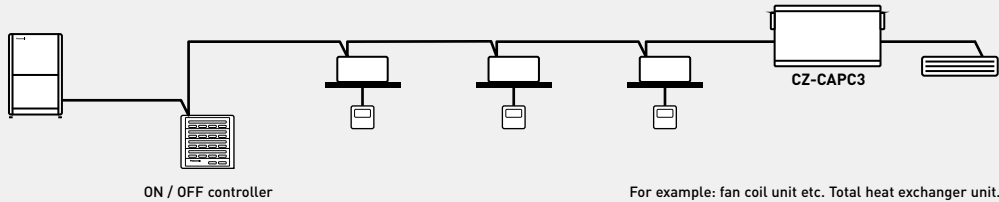

## Demand control for Mini ECOi (LZ2, LE2) outdoor units.

### CZ-CAPDC3

#### Connection with general equipment.

- Control of Mini ECOi (LZ2, LE2) outdoor units
- From the central control device, demand control and forced stop are possible



- Input: Demand (non-voltage contact / 24 V DC / 2 mA, static signal).
- Input: Forced stop operation (non-voltage contact / 24 V DC / 10 mA, static signal).
- Forced stop input for fire alarm input control.
- 3 step demand control for staged control of outdoor unit capacity.

#### Demand control.

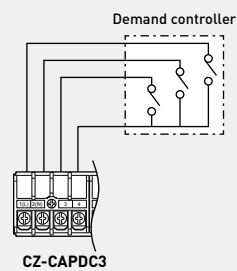

#### Forced stop.

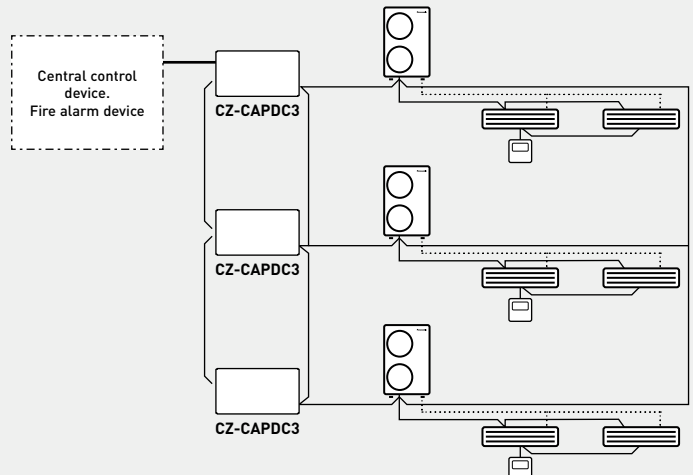
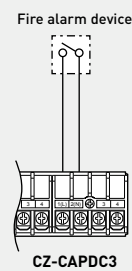

## Mini Seri-Para I/O Unit 0 -10 V

### CZ-CAPBC2

#### Connection with general equipment.

- Control and status monitoring is possible for individual indoor unit (1 group)
- In addition to operation and stop, there is a digital input function for air speed and operation mode
- Temperature setting and measuring of the indoor suction temperature can be performed from central monitoring
- Power is supplied from the T10 terminal of the indoor units
- The analog input for demand of the outdoor capacity by 20 steps (from 40% to 120%) by 0-10 V
- The analog input for temperature setting is 0 to 10 V, or 0 to 140 Ohm
- Separate power supply also is possible (in case of suction temperature measuring)

\* Ask to your distributor.

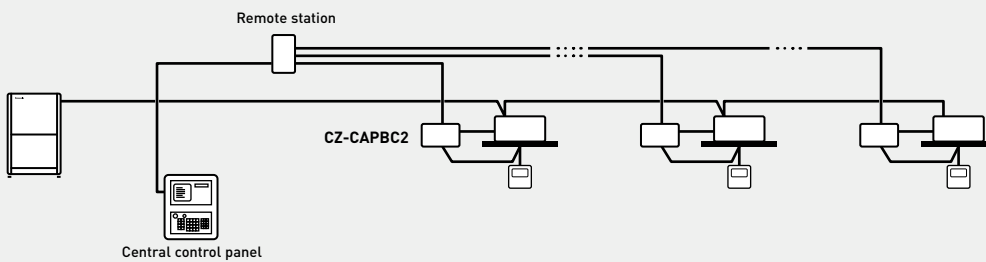

## Communication adaptor for VRF connectivity

### CZ-CFUNC2

This communication interface is required to connect a ECOi and GHP systems to a BMS. CZ-CFUNC2 is very easy to operate and to connect to the Panasonic S-Link, which is the ECOi bus. From the CZ-CFUNC2, all the indoor and outdoor units of the installation can be easily control. Two linked wiring systems can be connected to one CZ-CFUNC2.

Dimensions (H x W x D): 260 x 200 x 68 mm

\* As this is not a splash-proof design, it must be installed indoors or in the control panel, etc.



## PACi NX and VRF connectivity

Controls and connectivities are the key to offer better comfort and price. Panasonic offers its customers cutting-edge technology, specially designed to ensure our air conditioning systems deliver optimal performance.





**PACi, ECOi and ECO G connectivity.**

The interface has been designed specifically for Panasonic and provides complete monitoring, control and full functionality of the line-up from IntesisHome, KNX, Modbus, BACnet and LonWorks installations. This connectivity solution with "PAW" model names is made by a third party company, please contact Panasonic for more information.

	Room controller	Interface	BMS Type	Maximum number of indoor units connected
<b>PACi / ECOi indoor units</b>	SER8150R0B1194 / SER8150R5B1194		Modbus / BACnet	1 unit/group
	PAW-RE2C4-MOD-WH / PAW-RE2C4-MOD-BK		Modbus	1 unit/group
		PAW-RC2-KNX-1i	KNX	1 (1 group of indoor units)
		PAW-RC2-MBS-1	Modbus RTU <sup>1)</sup>	1 (1 group of indoor units)
		PAW-RC2-MBS-4	Modbus	4 Indoor/groups
		PAW-RC2-BAC-1	BACnet	1
		PAW-AZRC-KNX-1	KNX	1 (1 group of indoor units)
		PAW-AZRC-MBS-1	Modbus RTU <sup>1)</sup>	1 (1 group of indoor units)
<b>PACi / ECOi / ECO G S-Link</b>	PAW-AZRC-BAC-1	BACnet	1	
	PAW-AC2-BMS-16	KNX, Modbus and BACnet	16	
	PAW-AC2-BMS-64	KNX, Modbus and BACnet	64	
	PAW-AC2-BMS-128	KNX, Modbus and BACnet	128	
	CZ-CLNC2	LonWorks		16 groups of maximum 8 indoor units, in total maximum 64 indoor units

<sup>1)</sup> Interface Modbus RTU/TCP is needed in case if Modbus TCP connection. PAW-MBS-TCP2RTU (ModBus RTU Slave devices).

**Airzone. Control of the hide-aways**

Airzone has developed interfaces to easily connect to Panasonic Commercial hide-away units. Ensuring optimum performance, comfort and energy savings, the system is efficient and easy to install.

**Airzone full range of accessories for any duct project.**



Different type of outlets



Also plenum automatic doors



Full range of remote controls (wired / Infrared, ...)

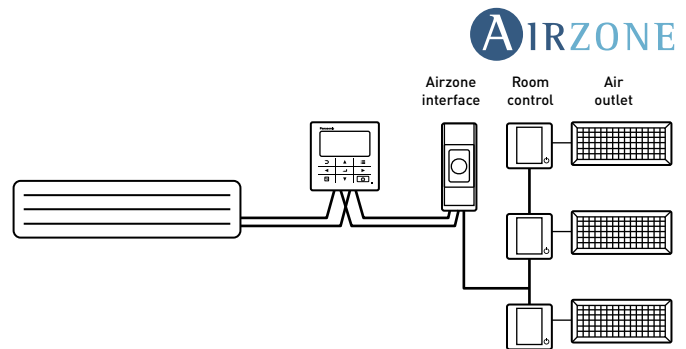

# PACi NX, ECOi and ECO G connectivity indoor units

## PCB's and cables for PACi NX, ECOi and ECO G indoor units

Name of the cables	Function	Comment
<b>CZ-T10</b>	All T10 functions	Requires field supplied accessory
<b>PAW-FDC</b>	Operate external fan	Requires field supplied accessory
<b>PAW-OCT</b>	All option monitoring signals	Requires field supplied accessory
<b>CZ-CAPE2</b>	3-Pipe control PCB	Requires additional wires from spare part supply
<b>PAW-EXCT</b>	Forced Thermo OFF/Leakage D	Requires field supplied accessory

Name of the PBC	Function	Comment
<b>PAW-T10</b>	All T10 functions	Allows easy connection "Plug & Play"
<b>PAW-PACR4</b>	PCB for server room application. Available for PACi NX, ECOi or ECO G	Interface for redundant operation up to 4 indoor unit groups

## T10 connector (CN061)

### CZ-T10

Panasonic has developed an optional accessory (consisting of plug + wires) called CZ-T10 to enable an easy connection to this T10 connector.



Connecting an ECOi indoor unit to an external device is easy. The T10 terminal featured in the electronic circuit board of all indoor units enables digital connection to external devices.

### T10 terminal specification (T10: CN061 at indoor unit PCB).

- Control items: 1. Start / stop input
- 2. Remote controller prohibit input
- 3. Start signal output
- 4. Alarm signal output

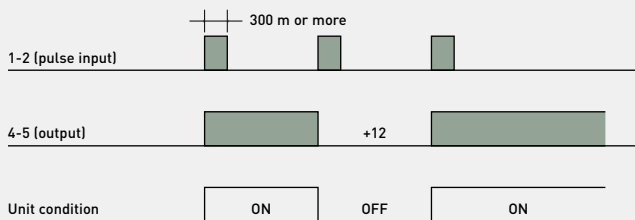

NOTE: The wire length from indoor unit to the relay must be within 2,0 m. Pulse signal changeable to static by cutting jumper JP001.

### Usage example.

#### Forced OFF control.

Term 1 and 2: Free contact for ON / OFF signal (cut \*JP1\* for static signal) when the hotel card is it connected the contact must be close (the unit can be used).

Term 2 and 3: Free contact to prohibit all function in the remote controller install in the room when the hotel card is it removed the contact must be closed (the unit can not work).

#### Terminal = T10

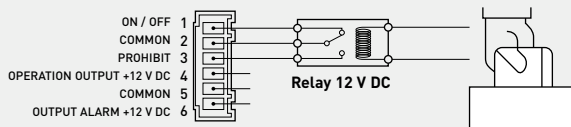

#### Condition:

- 1-2 (pulse input): Unit ON / OFF condition switching with a pulse signal. (1 pulse signal: shortage status more than 300 msec. or more)
- 2-3 (static input): open / operation with remote is permitted (normal condition) close / remote controller is prohibited
- 3-4 (static output): 12 V output during the unit ON / no output at OFF
- 4-5 (static output): 12 V output when some errors occur / no output at normal

#### Example of wiring:

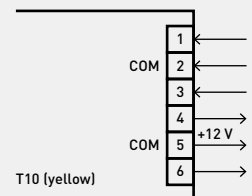

### Operation ON / OFF signal output.

#### Condition:

- 4-5 (static output): 12 V output during the unit ON / no output at OFF

#### Example of wiring:

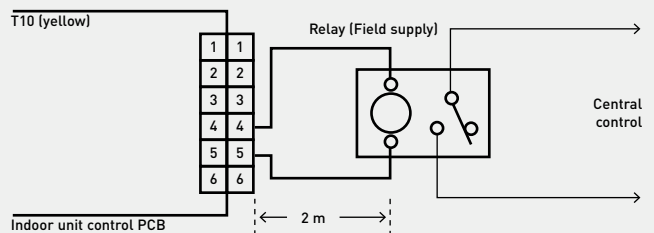

Note: The wire length from indoor unit to the Relay must be within 2,0 m. Pulse signal changeable to static by cutting jumper JP001.  
\* PACi NX Series is not compatible.

## Fan drive connector (CN032)

### PAW-FDC

Panasonic has developed an optional accessory (consisting of plug + wires) called PAW-FDC to enable an easy connection to this fan drive connector (CN032).

Operating the ventilation fan from the remote controller

- Start / stop of external ventilation and total heat exchanger fans
- Works even if indoor unit is stopped
- In case of group control > all fans will operate; no individual control

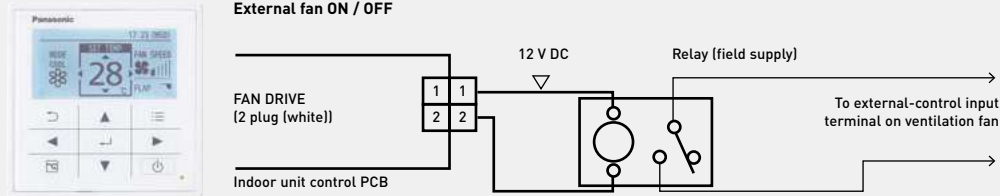

## Option connector (CN060) output external signals

### PAW-OCT

Panasonic has developed an optional accessory (consisting of plug + wires) called PAW-OCT to enable an easy connection to this Option Connector (CN060).

**With the combination of the T10 and the option CN060 an external control of the indoor units is possible!**

6P (white): Outputs external signals as shown in the figure below.

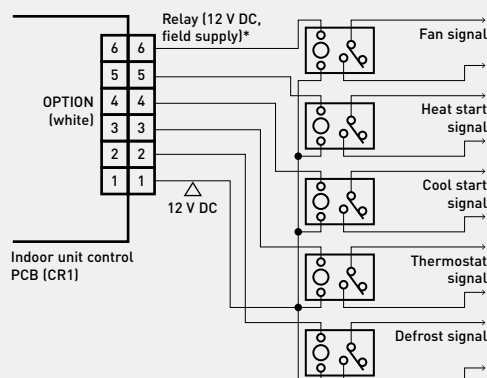

\* The relay must be installed at a distance of 2 m or less from the PCB.

## EXCT connector (CN073)

### PAW-EXCT

Panasonic has developed an optional accessory (consisting of plug + wires) called PAW-EXCT to enable an easy connection to this EXCT Connector (CN073).

#### A) With static input.

##### > STATIC INPUT > THERMO OFF > ENERGY SAVING

2P plug (red): Can be used for demand control. When input is present, forces the unit to operate with the thermostat OFF.

Note: The length of the wiring from the indoor unit control PCB to the relay must be 2 m or less.

· Examples of wiring:

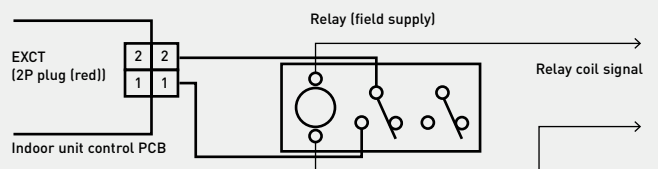

#### B) Example: In connection with a refrigerant sensor.

- Signal from leakage detector: non voltage, static.
- Indoor unit setting: Code 0b > 1
- Connector for leak detector: EXCT
- Outdoor unit setting:
  - Code C1 > 1 power output if alarm from O2 connector 230 V
  - Code C1 > 2 power output if alarm from O2 connector 0 V
- Displayed alarm message P14

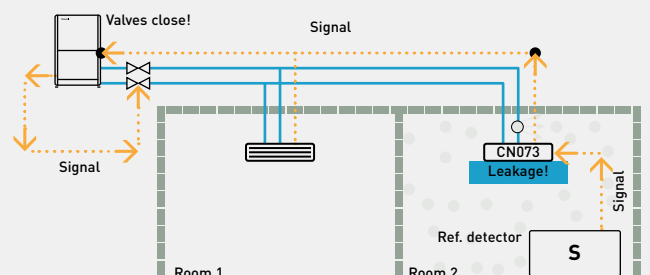



## Chillers, heat pumps and water source heat pumps

These new Series provide a wide variety of HVAC system solutions, to meet all of your commercial and industrial needs.





The reasons to choose Panasonic as your partner	→ 470
A wide variety of HVAC system solutions	→ 471
A wide coverage of application	→ 472
Solutions for hospitals	→ 474

<b>Air cooled chillers, heat pumps and condensing units - ECOi-W</b>	→ 476
ECOi-W AQUA-G BLUE R290	→ 478
Quick selection guide - Air cooled chillers	→ 480
Quick selection guide - Air cooled heat pumps	→ 482
Quick selection guide - Air cooled condensing units	→ 485
ECOi-W AQUA EVO H	→ 486
ECOi-W AQUA-G BLUE 50-80 H	→ 488
ECOi-W AQUA 20-40 C/H/E	→ 490
ECOi-W AQUA 45-125 C/H/E	→ 492
ECOi-W AQUA 140-210 C/H	→ 494
ECOi-W AQUA-Z 50-170 C/H	→ 496
ECOi-W AQUA-Z DC 150-380 C/H	→ 498
ECOi-W AQV C/H/E	→ 500
ECOi-W VL H/E	→ 504
ECOi-W AQUA EVO 230-360 C/H/E	→ 508
ECOi-W AQUA EVO 400-800 C/H	→ 512
ECOi-W SW-N EVO 380-1260 C	→ 514

<b>Water cooled chillers, heat pumps and condenserless units - ECOi-W</b>	→ 516
Quick selection guide - Water cooled chillers	→ 518
Quick selection guide - Water cooled heat pumps	→ 519
Quick selection guide - Water cooled condenserless units	→ 520
ECOi-W WQ 20-190 C/H/R	→ 522
ECOi-W WQ 524-1604 C/H/R	→ 524
ECOi-W WSW-N EVO 440-1550 C/H/R	→ 526

<b>Water source heat pumps - ECOi-LOOP</b>	→ 530
Quick selection guide - Water source heat pumps	→ 532
ECOi-LOOP 15-30 C/H · R410A	→ 534
ECOi-LOOP-N 70-135 H · R513A	→ 536
ECOi-LOOP-N EVO C/H · R513A	→ 538
ECOi-LOOP HRW H and ECOi-LOOP HRWE H · R407C	→ 540
ECOi-LOOP FS H · R407C	→ 542
ECOi-LOOP-N FS H · R513A	→ 544
Water source heat pumps control systems	→ 546

## The reasons to choose Panasonic as your partner

Unrivalled reliability and quality.

Panasonic solutions can be enjoyed for years to come, even in the most extreme climates.

Panasonic does not compromise on product quality, safety or durability, in order to provide the ultimate comfort when you need it most.



# A wide variety of HVAC system solutions

Panasonic solutions to suit a variety of commercial and industrial applications. Our systems provide the optimal performance in any climatic condition.



## 1 Air cooled chillers, heat pumps and condensing units - ECOi-W

The ECOi-W hydronic systems are perfect for any type of building. The air cooled chiller variant of the system is also a fundamental part of many industrial processes.

## 3 Water source heat pumps - ECOi-LOOP

Water source heat pumps are ideal for best in class hotels, offices or shopping centers. ECOi-LOOP solutions offer improved comfort by having several different indoor climates inside a building, while maintaining the energy through an internal closed water loop.

## 2 Water cooled chillers, heat pumps and condenserless units - ECOi-W

This system is particularly well suited for applications such as office buildings, hotels, shopping centers and hospitals.



### AC SELECT.

**Use AC SELECT to choose and configure your hydronic solution.**

Panasonic online selection tool offers an easy and quick solution to specify all the hydronics ranges and rooftops at required conditions.



<https://acselect.panasonic.eu/>

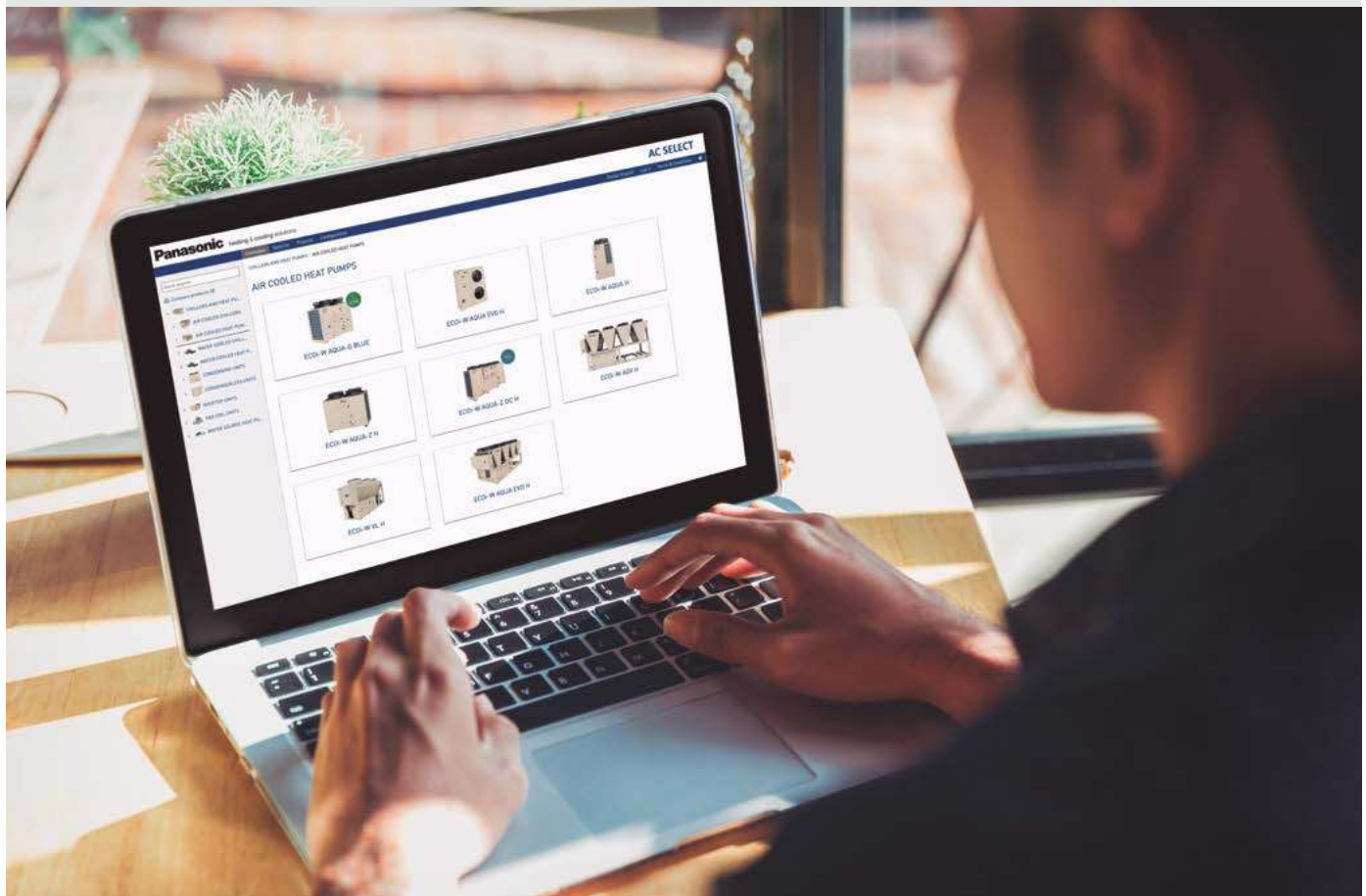

# A wide coverage of application

Energy efficiency, high performance and comfort.

## Chillers and heat pumps.

In residential applications a good indoor climate is important to ensure greater comfort and well-being. Our chillers and heat pump units with small capacities and DHW management are the ideal solutions.



## Chillers and heat pumps, fan coils and water source heat pumps.

Ensuring a comfortable environment for the guests is the main challenge in all the types of hotel.

Panasonic offers a complete system thanks to the wide capacity range of its chillers, the design and low-noise operation of its fan coil units and the zone independent management of different spaces with its water source heat pumps.

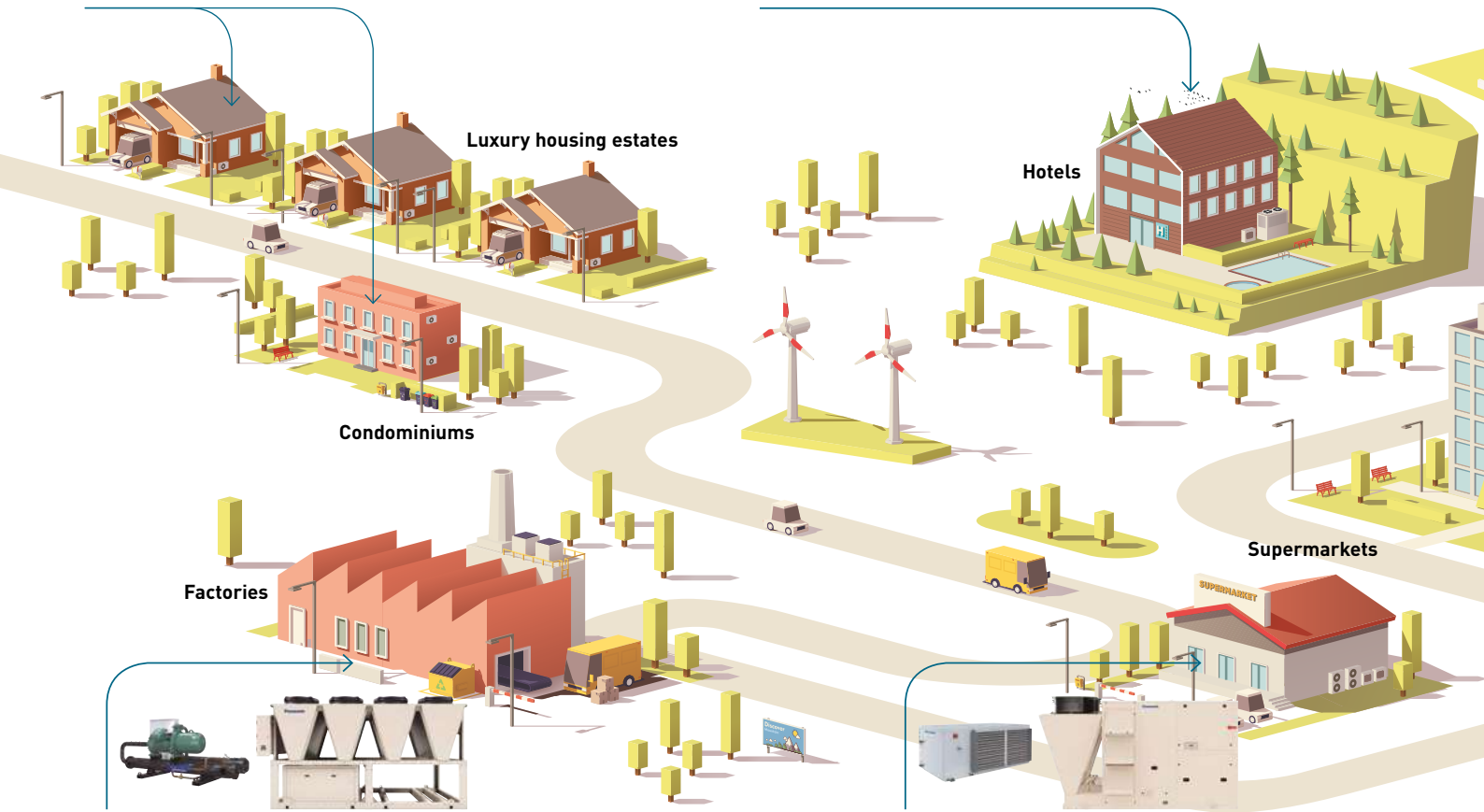

## Chillers and heat pumps.

Factories have high energy requirements. Panasonic chillers and heat pumps can meet this need due to the available capacity ranges. They also have high seasonal performance and are easy to install and maintain.

## Chiller application temperatures.



## Water source heat pumps and rooftops.

For supermarket applications, Panasonic has a wide range of solutions suitable to satisfy the required conditions: rooftops units can manage indoor ambient temperature and control the air quality, water source heat pumps have high efficiency and can allow independent zone management.



**Water source heat pumps and rooftops.**

Comfort and air conditioning needs in commercial buildings must take into account the high demand for energy, the high number of people during the day, and the need to heat or cool quickly, changing loads and constantly renewing air. Rooftops are the ideal solutions due to their high capacities and high air flow that ensures better air quality. Water source heat pumps, on the other hand, provide accurate local control of different spaces, with high reliability and allow the overall energy consumption to be broken down by zone.



Mall

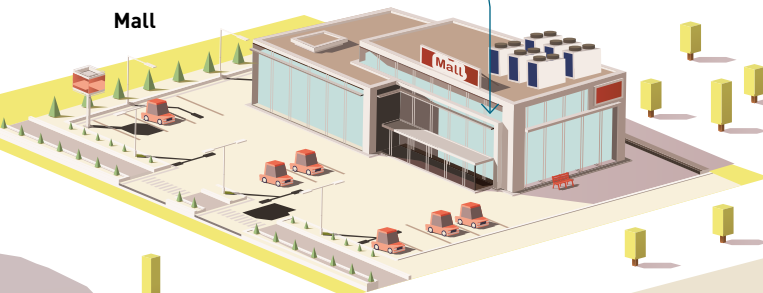

**Chillers and heat pumps, and rooftops.**

Energy consumption at airports has significant variability, and the number of users and passengers fluctuates throughout the day. For optimal air quality management and to meet the large energy needs of facilities, Panasonic offers a wide range of solutions like chillers and heat pumps and rooftops that guarantee high efficiency and minimise waste energy consumption.

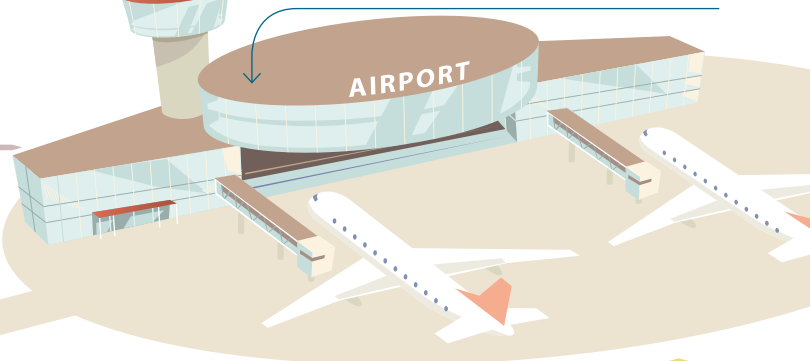

Airports



Offices / Large buildings



Hospitals



**Chillers and heat pumps, and fan coils.**

In offices, indoor climate is important for staff productivity and health. Panasonic chillers, heat pumps and fan coil units help create comfortable environments with high temperature control. Thanks to their natural refrigerant, R290 units are also the best solution for achieving high performance with reduced impact on the environment.

**Chillers and heat pumps, and rooftops.**

Hospitals require a high level of air quality and precise temperature control. Rooftop units are the best solutions due to their reliability and ability to provide fresh air through cooling, heating and ventilation of the building. The chiller and heat pump ranges help create an optimal indoor climate through their high performance and capacity. Our R32 ranges also have a low impact on the environment due to their low GWP refrigerant.

# Solutions for hospitals

ECOi-W Series offers a reliable solution with an optimised design for service and maintenance, making it ideal for hospital applications. Remote monitoring through the ECOi-W Cloud offers enhanced service support and a highly efficient fan coil range delivers increased comfort.



1



### High quality chillers and heat pumps.

ECOi-W Series provides a fully customisable design to meet the business application needs, with a capacity range from 20 kW to 1650 kW. Reliable quality and an optimised design for service and maintenance are ideal for hospital projects.

2



### A wide variety of fan coils.

A wide variety of units to suit your needs, with flexible installation options. High efficiency and low noise operation allows for optimum comfort.

Operation in both heating and cooling is possible.

3



### Intuitive controllers for fan coils.

Controllers with sophisticated designs provide a user friendly interface. An easy and low cost integration to building management systems.

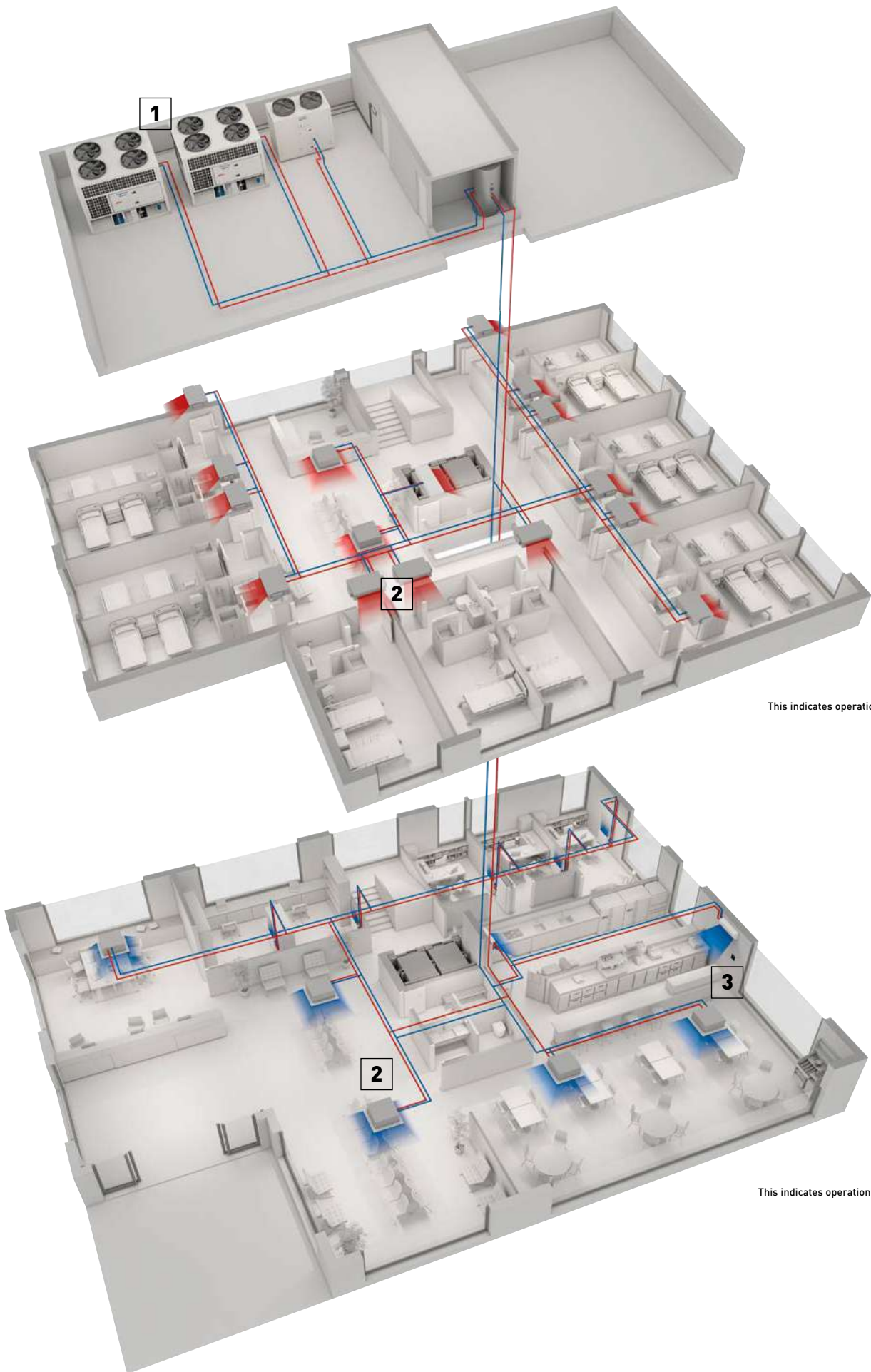

This indicates operation in winter.

This indicates operation in summer.

## Air cooled chillers, heat pumps and condensing units

Energy efficiency, high performance and comfort!

The ECOi-W hydronic systems offer the perfect combination of comfort and high efficiency. They are perfect for any type of building. The air cooled chiller variant of the system is also a fundamental part of many industrial processes.



An air cooled chiller uses ambient air to cool and condense the hot refrigerant in the condenser.

**Advantages:**

- Simple design (no need for cooling systems such as cooling towers), low installation costs
- Small footprint, easier to maintain and manage than water cooled systems
- Reduced initial cost

\* The below illustration show cooling application.

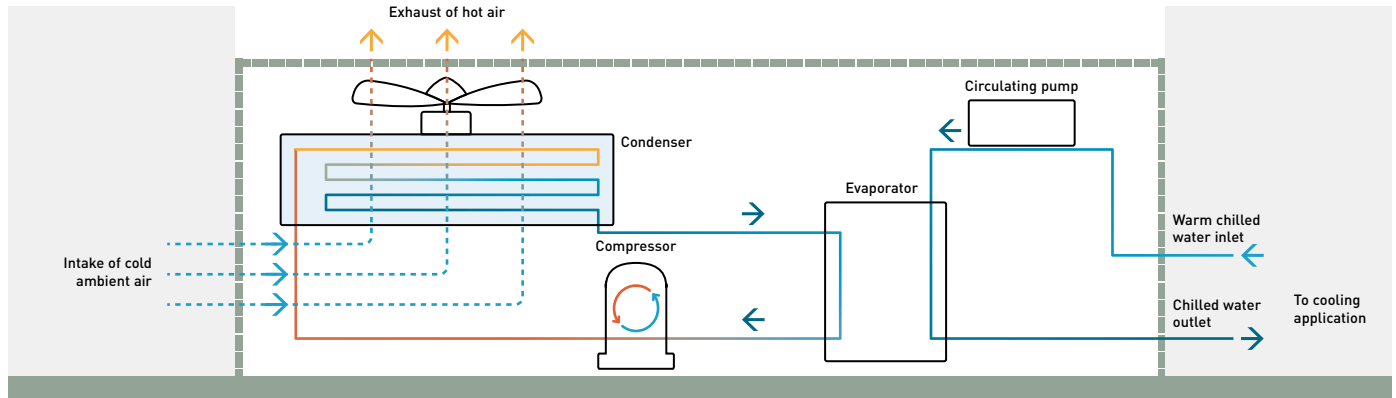

**Compressors and refrigerants combination**

**Scroll compressors.**

Scroll compressors have excellent low vibration and low noise properties. Compact in size and suitable for designs where space is restricted.



**Screw compressors.**

Screw compressors can be operated continuously and are therefore suitable for applications where a constant and consistent cooling load is required. Due to their high energy efficiency, our products use these compressors in combination with high-efficiency refrigerants.



**In-house manufactured coils**

100% quality certified by Panasonic is ensured by coil production in our factory. Hydrophilic aluminium (Bluefin) treatment is available as standard. Special Epoxy coating with strong protection against corrosion can be requested as option.



**Microchannel coils**

Significant reduction on refrigerant charge and operating weight.



**Ecodesign**

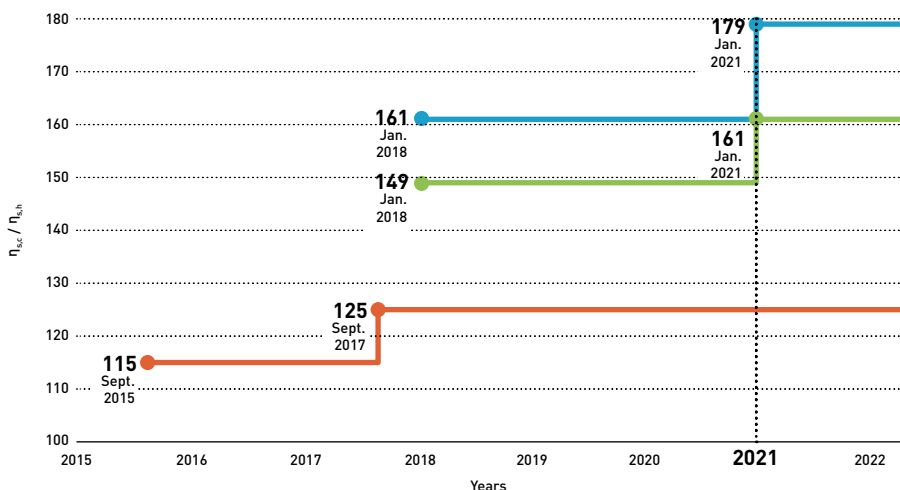

**Air to water comfort chiller <sup>1)</sup>**

≤400 kW. Minimum η<sub>sc</sub> to be Ecodesign compliant. COMMISSION REGULATION (EU) 2016/2281.

>400 kW. Minimum η<sub>sc</sub> to be Ecodesign compliant. COMMISSION REGULATION (EU) 2016/2281.

**Air to water heat pumps <sup>2)</sup>**

≤400 kW. Minimum η<sub>h</sub> to be Ecodesign compliant. COMMISSION REGULATION (EU) No813/2013.

>400 kW. Minimum η<sub>h</sub> to be Ecodesign compliant. COMMISSION REGULATION (EU) 2016/2281.

1) Calculated at nominal conditions: chilled water inlet/outlet temperature: 12/7 °C, outdoor ambient temperature 35 °C DB.  
 2) Rated heat output of space heaters and combination heaters at reference design conditions (T<sub>design</sub> -10 °C) as stated in COMMISSION REGULATION (EU) No 813/2013.

# ECOi-W AQUA-G BLUE. A revolutionary solution

Reversible heat pumps with high leaving water temperature.

Introducing a revolutionary solution for sustainable cooling and heating needs, ECOi-W AQUA-G BLUE powered by R290, a natural refrigerant. It delivers both sustainability and efficiency in one innovative package.



			<p><b>HIGH SEER</b> Max. 4,4 <sup>2)</sup></p> <p><b>HIGH SCOP</b> Max. 3,9 <sup>3)</sup></p>	
<p><b>Natural refrigerant R290 with GWP 0,02 <sup>1)</sup>.</b></p>	<p><b>Reliable quality.</b></p>	<p><b>Scroll compressors.</b></p>	<p><b>High seasonal efficiency.</b></p>	<p><b>High energy efficiency class.</b></p>
<p><b>DHW management.</b></p>	<p><b>Maximum 70 °C leaving water temperature.</b></p>	<p><b>Quiet operation.</b></p>	<p><b>Boost the capacity up to 640 kW.</b></p>	

1) Based on the Sixth Assessment Report (AR6) adopted by the Intergovernmental Panel on Climate Change (IPCC). 2) Size 50. According EN 14825 and Following COMMISSION REGULATION (EU) 2016/2281. 3) Size 70. According EN 14825 and Following COMMISSION REGULATION (EU) No 813/2013. 4) Scale A+++ to D. According EN 14825 and Following COMMISSION REGULATION (EU) No 813/2013.



### Air cooled heat pumps R290. The future of efficient commercial air to water heat pumps.



#### Care about the environment and get greater efficiency.

ECOi-W AQUA-G BLUE is born from a perfect combination of new green technology and our existing ECOi-W product range already known for its performance and reliability. It operates with the natural R290 refrigerant that offers greater efficiency while having almost no impact on the environment with one of the lowest **GWP (Global Warming Potential): only 0,02!\*** Make the choice to reach incredible efficiencies, extend the operating limits, and contribute to environmental preservation.

Based on the Sixth Assessment Report (AR6) adopted by the Intergovernmental Panel on Climate Change (IPCC).



50 kW



60 kW



70 - 80 kW

### Extended operating limits

Operating range in cooling mode.

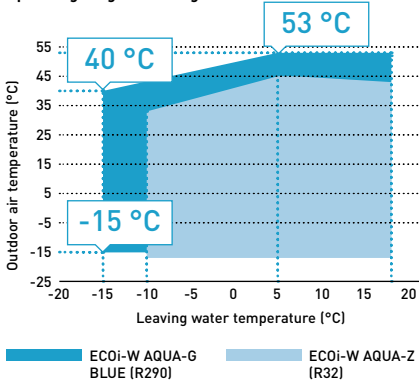

Operating range in heating mode.

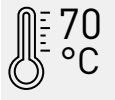
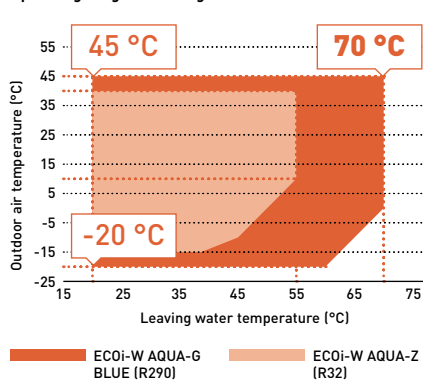

#### Cooling mode.

A water outlet temperature of -15 °C ensures optimal operation temperature for process equipment in factories.

#### Heating mode.

Ideal solution for Heating and Domestic Hot Water production. Reaching 70 °C from 0 °C outside air temperature.

### Quiet operation. Discover a unique feature of ECOi-W AQUA-G BLUE

Sound power level (dB(A)).

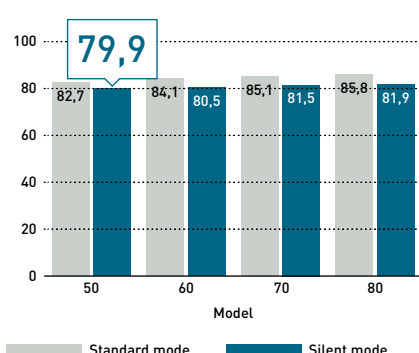

Sound pressure level (dB(A)).

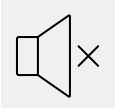
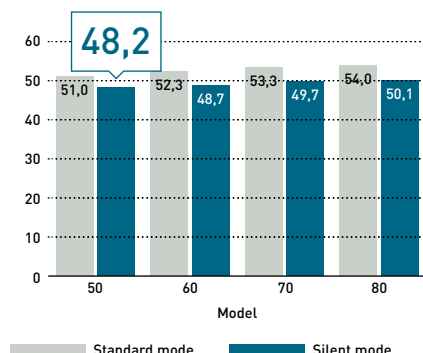

#### Silent mode.

Silent mode with an impressively low sound power level of only 79,9 dB(A), pressure level of only 48,2 dB(A). ECOi-W AQUA-G BLUE provides the perfect balance of efficiency and silent operation. Optional compressor jackets for size 50 and optional compressor box for sizes 60-70-80 are available to provide an additional level of noise reduction.





# Quick selection guide - Air cooled chillers

Page	Size	Cooling capacity (kW)	SEER	Sound power (dB(A))	Dimension LxHxW (mm)
P. 490	<b>ECOi-W AQUA C - R410A</b>				
	20	19,2	4,78	75	1000 x 1983 x 1000
	25	24,3	4,38	75	1000 x 1983 x 1000
	30	27,1	4,43	75	1000 x 1983 x 1000
	35	36,7	4,43	76	1000 x 1983 x 1000
P. 492	40	39,0	4,48	76	1000 x 1983 x 1000
	45	45,3	4,40	80	2180 x 1986 x 1160
	55	52,0	4,53	80	2180 x 1986 x 1160
	65	66,1	4,53	80	2180 x 1986 x 1160
	75	73,1	4,68	80	2180 x 1986 x 1160
	90	90,9	4,45	83	2180 x 2286 x 1160
	105	104,0	4,50	83	2180 x 2286 x 1160
P. 494	125	123,0	4,55	83	2180 x 2286 x 1160
	140	132,0	4,40	85	2856 x 2295 x 2210
	150	146,0	4,45	85	2856 x 2295 x 2210
	170	164,0	4,38	87	2856 x 2321 x 2210
	190	181,0	4,40	88	2856 x 2321 x 2210
	210	208,0	4,25	88	2856 x 2321 x 2210
P. 496	<b>ECOi-W AQUA-Z C - R32</b>				
	50	51,6	4,60	83	2180x x 1986 x 1160
	60	57,6	4,59	84	2180x x 1986 x 1160
	70	69,7	4,61	81	2180x x 1986 x 1160
	75	78,2	4,72	81	2180x x 1986 x 1160
	85	82,8	4,45	84	2180x x 2286 x 1160
	100	100,0	4,88	86	2180x x 2286 x 1160
	115	116,0	4,59	87	2180x x 2286 x 1160
	130	126,0	4,43	87	2180x x 2286 x 1160
P. 498	<b>ECOi-W AQUA-Z DC C - R32</b>				
	150	151,0	4,93	89,6	3795 x 2240 x 1152
	170	170,0	4,90	90,4	3795 x 2240 x 1152
P. 498	<b>ECOi-W AQUA-Z DC C - R32</b>				
	190	189,0	4,68	91,1	2676 x 2250 x 2211
	210	212,0	4,62	91,5	2676 x 2250 x 2211
	230	229,0	4,48	92,0	2676 x 2250 x 2211
	260	260,0	4,40	92,4	2676 x 2250 x 2211
	290	307,0	4,63	93,3	3801 x 2250 x 2211
	320	326,0	4,33	94,3	3801 x 2250 x 2211
350	346,0	4,43	95,2	3801 x 2250 x 2211	
380	377,0	4,35	95,4	3801 x 2250 x 2211	

\* Dimensions without water tank.





Page	Size	Cooling capacity (kW)	SEER	Sound power (dB(A))	Dimension <sup>1)</sup> L x H x W (mm)
<b>P. 500</b> 	85	83,5	4,55	84	2555 x 2185 x 1095
	95	93,6	4,80	84	2555 x 2185 x 1095
	105	103,0	4,78	84	2555 x 2185 x 1095
	115	110,1	4,80	84	2555 x 2185 x 1095
	125	121,9	4,73	88	3155 x 2185 x 1095
	140	136,6	4,53	88	3155 x 2185 x 1095
<b>P. 508</b> 	230	231,0	4,25	92	3500 x 2500 x 2150
	260	263,0	4,25	93	3500 x 2500 x 2150
	280	284,0	4,23	93	3500 x 2500 x 2150
	300	310,0	4,18	94	4550 x 2500 x 2150
	330	331,0	4,20	95	4550 x 2500 x 2150
	360	362,0	4,10	95	4550 x 2500 x 2150
<b>P. 512</b> 	400	390,4	4,48	92	4580 x 2500 x 2175
	450 S <sup>2)</sup>	431,1	4,63	87	5620 x 2500 x 2175
	490 S <sup>2)</sup>	470,2	4,58	87	6680 x 2500 x 2175
	530 S <sup>2)</sup>	513,7	4,78	87	6680 x 2500 x 2175
	600	584,5	4,58	94	7760 x 2500 x 2175
	670	653,2	4,59	94	7760 x 2500 x 2175
	750 S <sup>2)</sup>	727,7	4,73	89	8900 x 2500 x 2175
	800 S <sup>2)</sup>	775,4	4,70	89	8900 x 2500 x 2175
<b>P. 514</b> 	380	365,7	4,53	97	4660 x 2510 x 2192
	440	443,0	4,64	98	5712 x 2510 x 2192
	510	500,2	4,65	100	5712 x 2510 x 2192
	590	565,8	4,80	100	6764 x 2510 x 2192
	660	643,5	4,66	100	7816 x 2510 x 2192
	730	704,3	4,56	101	7816 x 2510 x 2192
	810	778,1	4,62	101	8868 x 2510 x 2192
	900	896,9	4,56	102	9920 x 2510 x 2192
	980	983,5	4,60	102	10972 x 2510 x 2192
	1060	1047,4	4,87	103	12024 x 2510 x 2192
	1160	1154,0	4,86	103	13076 x 2510 x 2192
	1260	1240,5	4,85	103	13076 x 2510 x 2192



1) Dimensions without water tank. 2) S version.

# Quick selection guide - Air cooled heat pumps

Page	Size	Cooling and heating capacity (kW)	SEER / SCOP	Sound power (dB(A))	Dimension LxHxW (mm)
P. 486	20	21,0	3,30 / 3,75	74	1477 x 1615 x 539
		20,4			
P. 486	30	28,0	3,98 / 3,68	75	1477 x 1615 x 539
		26,1			
P. 488	50	48,2	4,40 / 3,70	83	2215 x 1730 x 1032
		49,2			
	60	56,1	4,30 / 3,70	84	2180 x 2011 x 1160
		61,1			
70	64,9	4,30 / 3,90	85	2180 x 2030 x 1160	
	73,5				
80	74,1	4,20 / 3,80	85	2180 x 2030 x 1160	
	83,6				
P. 490	20	18,7	4,68 / 3,50	75	1000 x 1983 x 1000
	25	23,7			
	30	26,4			
	35	35,8			
	40	38,1			
	45	44,3			
P. 492	55	50,9	4,41 / 3,38	80	2180 x 1986 x 1160
	65	64,1			
	75	71,0			
	90	88,7			
	105	101,0			
	125	119,0			
P. 494	140	128,0	4,39 / 3,30	85	2856 x 2295 x 2210
	150	142,0			
	170	164,0			
	190	178,0			
	210	208,0			
	210	218,0			



\* Dimensions without water tank.



Page	Size	Cooling and heating capacity (kW)	SEER / SCOP	Sound power (dB(A))	Dimension LxHxW (mm)	
P. 496	 R32	50	51,1 51,7	4,46 / 3,63	83	2180 x 1986 x 1160
		60	57,0 59,7	4,42 / 3,51	84	2180 x 1986 x 1160
		70	69,0 71,8	4,51 / 3,49	81	2180 x 1986 x 1160
		75	77,4 78,5	4,61 / 3,56	81	2180 x 1986 x 1160
		85	82,0 86,5	4,33 / 3,76	84	2180 x 2286 x 1160
		100	99,3 107,6	4,77 / 3,56	86	2180 x 2286 x 1160
		115	115,0 122,3	4,44 / 3,77	87	2180 x 2286 x 1160
		130	125,0 137,5	4,23 / 3,81	87	2180 x 2286 x 1160
		150	152,0 159,1	4,59 / 3,78	89	3789 x 2285 x 1151
		170	170,0 180,1	4,49 / 3,70	91	3789 x 2285 x 1151
P. 498	 R32	150	150,0 154,0	4,75 / 3,83	89,6	3795 x 2240 x 1152
		170	167,0 178,0	4,71 / 3,90	90,4	3795 x 2240 x 1152
		190	184,0 190,0	4,45 / 3,46	91,1	2678 x 2250 x 2211
		210	204,0 201,0	4,39 / 3,44	91,5	2678 x 2250 x 2211
		220**	208,0 219,0	5,03 / 3,86	91,3	2676 x 2300 x 2211
		230	224,0 241,0	4,34 / 3,64	92,0	2678 x 2250 x 2211
		260	251,0 256,9	4,21 / 3,52	92,4	2678 x 2250 x 2211
		270**	265,0 288,0	5,01 / 3,82	92,8	3801 x 2300 x 2211
		290	291,1 285,6	4,34 / 3,51	93,3	3801 x 2250 x 2211
		300**	295,0 312,0	5,01 / 3,92	93,1	3801 x 2300 x 2211
P. 500	 R32	85	81,0 91,8	4,25 / 3,61	84	2555 x 2185 x 1095
		95	89,9 102,8	4,68 / 3,64	84	2555 x 2185 x 1095
		105	98,9 110,0	4,63 / 3,78	84	2555 x 2185 x 1095
		115	106,9 119,0	4,17 / 3,77	84	2555 x 2185 x 1095
		125	115,8 134,0	4,33 / 3,47	88	3155 x 2185 x 1095
		140	129,2 146,9	4,28 / 3,54	88	3155 x 2185 x 1095





\* Dimensions without water tank. \*\* Only EC fans version.

# Quick selection guide - Air cooled heat pumps

Page	Size	Cooling and heating capacity (kW)	SEER / SCOP	Sound power (dB(A))	Dimension <sup>1)</sup> LxHxW (mm)	
P. 504		704	173,2 200,1	3,63 / 3,41	93	4300 x 2300 x 1100
		804	197,1 223,2	3,55 / 3,42	93	4300 x 2300 x 1100
		904	226,4 254,7	3,35 / 3,28	94	4300 x 2300 x 1100
		1004	246,3 270,8	3,50 / 3,39	94	4300 x 2300 x 1100
		1104	273,1 302,1	3,53 / 3,30	95	4300 x 2300 x 1100
		1204	299,9 337,4	3,43 / 3,19	95	4300 x 2300 x 1100
P. 508		230	213,6 229,0	4,13 / 3,46	92	3500 x 2500 x 2150
		260	243,7 262,3	4,05 / 3,48	93	3500 x 2500 x 2150
		280	261,1 279,6	4,10 / 3,44	93	3500 x 2500 x 2150
		300	287,8 305,6	3,83 / 3,51	94	4550 x 2500 x 2150
		330	307,4 327,2	3,80 / 3,44	95	4550 x 2500 x 2150
		360	340,5 361,4	3,93 / 3,48	95	4550 x 2500 x 2150
P. 512		400	365,6 404,0	4,65 / 3,46	92	5620 x 2500 x 2175
		450	410,3 450,9	4,53 / 3,47	93	5620 x 2500 x 2175
		490	444,9 492,7	4,70 / 3,37	93	6680 x 2500 x 2175
		530	479,3 532,1	4,55 / 3,38	94	6680 x 2500 x 2175
		580 S <sup>2)</sup>	520,1 585,6	4,60 / —	80	7760 x 2500 x 2175
		620 S <sup>2)</sup>	566,3 627,1	4,60 / —	88	8800 x 2500 x 2175
		670 S <sup>2)</sup>	608,3 676,7	4,55 / —	88	8800 x 2500 x 2175
		750 S <sup>2)</sup>	686,6 757,4	4,55 / —	89	9950 x 2500 x 2175
		800 S <sup>2)</sup>	727,5 805,3	4,58 / —	89	9950 x 2500 x 2175

1) Dimensions without water tank. 2) S version.

# Quick selection guide - Air cooled condensing units

Page	Size	Cooling capacity (kW)	EER	Sound power (dB(A))	Dimension LxHxW (mm)
<b>ECOi-W AQUA E · R410A</b>    <b>P. 490</b>	25	32,4	3,24	75	1000 x 1983 x 1000
	30	33,7	3,15	75	1000 x 1983 x 1000
	35	43,1	2,90	76	1000 x 1983 x 1000
	40	44,8	2,99	76	1000 x 1983 x 1000
	45	57,4	2,94	80	2180 x 1986 x 1160
  <b>P. 492</b>	55	64,5	2,89	80	2180 x 1986 x 1160
	65	72,4	2,97	80	2180 x 1986 x 1160
	75	79,3	2,91	80	2180 x 1986 x 1160
	90	104,0	2,65	83	2180 x 2286 x 1160
	105	120,0	2,79	83	2180 x 2286 x 1160
	125	136,0	2,66	83	2180 x 2286 x 1160
	<b>ECOi-W AQV E · R410A</b>    <b>P. 500</b>	85	92,1	3,36	84
95		103,2	3,29	84	2555 x 2185 x 1095
105		113,2	3,32	84	2555 x 2185 x 1095
115		121,8	3,30	84	2555 x 2185 x 1095
125		134,7	3,23	88	3155 x 2185 x 1095
140		151,0	3,23	88	3155 x 2185 x 1095
<b>ECOi-W VL E · R410A</b>    <b>P. 504</b>	704	199,0	2,90	93	4300 x 2300 x 1100
	804	224,0	3,00	93	4300 x 2300 x 1100
	904	258,0	2,98	94	4300 x 2300 x 1100
	1004	283,0	3,12	94	4300 x 2300 x 1100
	1104	315,0	2,98	95	4300 x 2300 x 1100
	1204	347,0	2,90	95	4300 x 2300 x 1100
<b>ECOi-W AQUA EVO E · R410A</b>    <b>P. 508</b>	230	250,3	3,36	92	3500 x 2500 x 2150
	260	288,4	3,42	93	3500 x 2500 x 2150
	280	312,7	3,42	93	3500 x 2500 x 2150
	300	337,2	3,39	94	4550 x 2500 x 2150
	330	361,2	3,45	95	4550 x 2500 x 2150
	360	394,5	3,37	95	4550 x 2500 x 2150

\* Dimensions without water tank.



# ECOi-W AQUA EVO H · R410A

Air cooled heat pumps Inverter.

Cooling capacity: 20,0 to 35,9 kW.

Heating capacity: 20,4 to 34,0 kW.



## Operating limits

To be confirmed with AC SELECT:  
<https://acselect.panasonic.eu/>

### Ambient temperature.

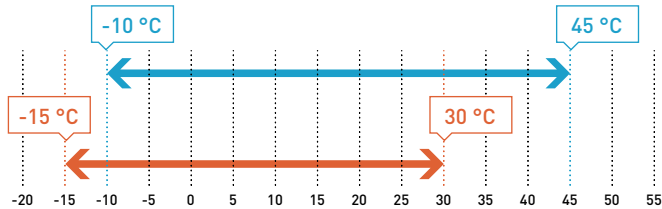

### Leaving water temperature.

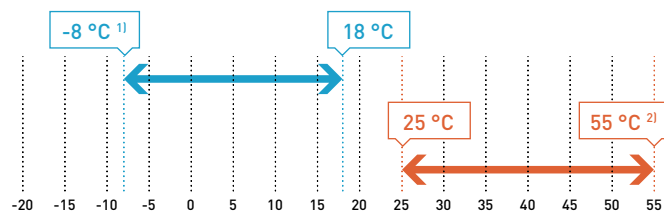

Cooling: outside air temperature [°C (DB)]. Heating: outside air temperature [°C (WB)].

1) Below 5 °C, glycol is required. For operation below 0 °C contact sales office.

2) Maximum leaving water temperature 55 °C [minimum outdoor air temperature -10 °C size 20, -15 °C size 30] to be confirmed with AC SELECT.

Chillers suitable for operation without buffer tank for water content greater than 2,5 liters of water per kW of output.

## The range at a glance

- 1 version: H (heat pump)
- 2 sizes

## Advantages

- Wide load variation capability:
  - Cooling operation down to 30% and up to 140% of nominal capacity
  - Heating operation down to 40% and up to 130% of nominal capacity
- Unit optimization in heating mode for both fan coil and floor applications
- Wide operating limits in heating mode
- Domestic Hot Water management
- Inverter compressor
- New fan motors (ErP compliant) with integrated grill and fan speed control as standard

## Equipment

- Inverter driven compressor
- Plate evaporator (AISI 316)
- A single Inverter driven 3-phase scroll compressor equipped with variable frequency brushless motor (20-120 Hz)
- 1 refrigerant circuit
- Bi-flow electronic expansion valve
- Multistage centrifugal pump as standard
- Bluefin coil
- Operating low water content in the plant
- Automatic circuit breaker
- Coil grilles
- Fan speed control
- Power factor corrector capacitors
- Phase sequence control
- Soft starter
- Water differential pressure switch
- Water filter
- DHW function available on the controller with DHW probe and 3 way valve available as options

## AC SELECT.

Smart and user-friendly selection tool. Configure your air conditioning solution at required conditions:  
<https://acselect.panasonic.eu/>





## Technical performance

Size			20	30
ECOi-W AQUA EVO H			P-AQAVE0020HA	P-AQAVE0030HA
Power supply	Voltage	V	400	400
	Phase		Three phase	Three phase
	Frequency	Hz	50	50
Cooling capacity <sup>1)</sup>	Nominal (Min - Max)	kW	20,0 (9,33 - 28,0)	29,0 (13,9 - 35,9)
Input power <sup>1)</sup>	Nominal (Min - Max)	kW	4,15 (2,38 - 6,61)	7,24 (3,51 - 13,0)
EER <sup>1)</sup>	Nominal (Min - Max)		4,82 (3,92 - 4,24)	4,01 (3,96 - 2,76)
Cooling capacity <sup>2)</sup>	Nominal (Min - Max)	kW	21,0 (6,60 - 25,2)	28,0 (9,43 - 31,1)
Input power <sup>2)</sup>	Nominal (Min - Max)	kW	6,95 (2,52 - 10,3)	10,9 (3,14 - 12,4)
EER <sup>2)</sup>	Nominal (Min - Max)		3,02 (2,62 - 2,45)	2,57 (3,00 - 2,51)
EER 75%			3,83	3,65
EER 50%			4,53	4,48
EER 25%			3,80	4,79
<b>SEER <sup>3)</sup></b>			<b>3,30</b>	<b>3,98</b>
$\eta_{s,c}$ <sup>3)</sup>			<b>129</b>	<b>156</b>
Nominal water flow (in the evaporator)		m <sup>3</sup> /h	3,64	5,92
Heating capacity <sup>4)</sup>	Nominal (Min - Max)	kW	20,4 (9,94 - 29,4)	26,1 (11,5 - 34,0)
Input power <sup>4)</sup>	Nominal (Min - Max)	kW	5,02 (2,98 - 8,37)	6,45 (3,01 - 9,80)
COP <sup>4)</sup>	Nominal (Min - Max)		4,06 (3,34 - 3,51)	4,05 (3,82 - 3,47)
Heating capacity <sup>5)</sup>	Nominal (Min - Max)	kW	20,4 (8,90 - 27,4)	26,1 (10,2 - 33,9)
Input power <sup>5)</sup>	Nominal (Min - Max)	kW	6,44 (3,34 - 9,64)	8,42 (3,97 - 11,6)
COP <sup>5)</sup>	Nominal (Min - Max)		3,17 (2,66 - 2,84)	3,10 (2,57 - 2,91)
<b>SCOP <sup>6)7)</sup></b>			<b>3,75</b>	<b>3,68</b>
<b>Energy efficiency class <sup>6)7)</sup></b>		<b>A+++ to D</b>	<b>A+</b>	<b>A+</b>
$\eta_{s,h}$ <sup>6)7)</sup>			<b>147</b>	<b>144</b>
<b>SCOP <sup>6)8)</sup></b>			<b>3,00</b>	<b>2,95</b>
<b>Energy efficiency class <sup>6)8)</sup></b>		<b>A+++ to D</b>	<b>A+</b>	<b>A+</b>
$\eta_{s,h}$ <sup>6)8)</sup>			<b>117</b>	<b>115</b>
Nominal water flow (in the evaporator)		m <sup>3</sup> /h	3,64	5,92
Sound power <sup>9)</sup>		dB(A)	74	75
Sound pressure at 10 m <sup>10)</sup>		dB(A)	43	44

## Physical features

ECOi-W AQUA EVO H			20	30
Dimension	H x W x L	mm	1615 x 539 x 1477	1615 x 539 x 1477
Operating weight		kg	260	275
<b>Water connections</b>				
Type of water connections (evaporator)			Male gas threaded	Male gas threaded
Water inlet/outlet diameter		Inch	1 ¼	1 ¼

1) According to EN 14511-2013: chilled water inlet/outlet temperature: 23/18 °C, outdoor ambient temperature 35 °C. 2) According to EN 14511-2013: chilled water inlet/outlet temperature: 12/7 °C, outdoor ambient temperature 35 °C DB. 3) According to EN 14825 standard. 4) According to EN 14511-2013: warm water inlet/outlet temperature: 30/35 °C, outdoor ambient temperature 7 °C DB/6 °C WB. 5) According to EN 14511-2013: warm water inlet/outlet temperature: 40/45 °C, outdoor ambient temperature 7 °C DB/6 °C WB. 6) ErP compliant: following COMMISSION REGULATION (EU) No 813/2013. 7) According to EN 14825 standard - low temperature application (35 °C). 8) According to EN 14825 standard - medium temperature application (55 °C). 9) Sound levels are at fully loaded conditions. Sound power values refers to ISO 3744 standard. 10) Sound pressures refer to ISO 3744 standard, parallelepiped shape.

### Accessories and options

Buffer tank placed under unit  
Chassis acoustic insulation

### Accessories and options

Coils treatments

### Accessories supplied loose

**P-373705** Water temperature sensor for second set-point zone  
**P-347941** Remote ON / OFF control  
**P-364735** Remote keyboard panel  
**P-362577** Flow switch  
**P-473465** Pressure switch

### Accessories supplied loose

**P-362384** Valves in - out  
**P-348144** 3WV DHW - 3 way valve for DHW production - ON / OFF - DN 20  
**P-375890** 3WV SSP - 3 way valve for second set-point zone - 0-10 V - DN 25  
**P-375891** 3WV SSP - 3 way valve for second set-point zone - 0-10 V - DN 32





# ECOi-W AQUA-G BLUE 50-80 H - R290

Air cooled heat pumps.

Cooling capacity: 48,2 to 74,1 kW.

Heating capacity: 49,2 to 83,6 kW.



## The range at a glance

- 1 version: H (heat pump)
- 4 sizes
- 2 acoustic options: STD (standard) and S (super low noise)

## Advantages

- A super eco-friendly unit - employs natural refrigerant R290 with GWP 0,02
- Very high performance and improved energy efficiencies
- Smart energy consumption
- Expanded operating limit
- Domestic Hot Water management
- Compact chassis
- Very quiet operation
- Cascade controller available for multi system operation
- SG Ready
- Very low refrigerant charge
- Reliable safety measurements

## Operating limits

To be confirmed with AC SELECT:  
<https://acselect.panasonic.eu/>

Ambient temperature.

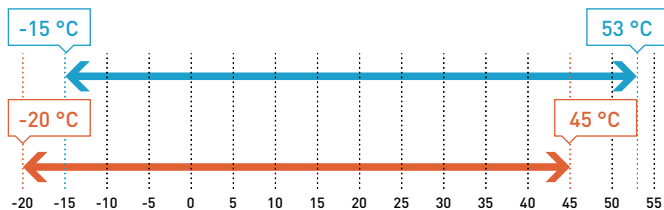

Leaving water temperature.

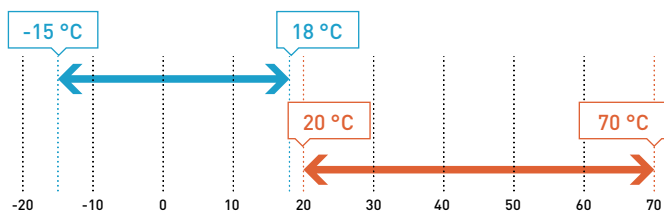

## Equipment

- Fan speed control. All units are equipped with EC fan technology
- Variable speed pump - option. A variable speed pump can be added to the unit for even greater energy savings
- Controller. This new high standard control system provides excellent pressure control, as well as global and optimised unit management
- Removable panels. Great accessibility to internal components for service operations
- Condenser. Highly optimised heat exchanger design enables a refrigerant charge reduction. Lower than 5,0 kg of R290 for the sizes 50 and 60
- Sealed electrical box. Non-flammable control box. The core parts are protected with a sealed metallic box
- Electronic expansion valve. This reliable and high-performant valve minimises overheating of the evaporator. It is directly managed by the control system
- Modbus RTU, Modbus TCP/IP, BACnet MSTP or BACnet IP
- Leak detector and safety ventilation fans to detect R290 leakages and exhaust refrigerant to atmosphere in the event of a leak
- DHW function available on the controller with DHW probe and 3 way valve available as options

## AC SELECT.

Smart and user-friendly selection tool. Configure your air conditioning solution at required conditions:  
<https://acselect.panasonic.eu/>







## Technical performance

Size			50	60	70	80
Power supply	Voltage	V	400	400	400	400
	Phase		Three phase	Three phase	Three phase	Three phase
	Frequency	Hz	50	50	50	50
<b>ECOi-W AQUA-G BLUE 50-80 H EC fan - heat pump</b>			<b>P-AQAG0050HA</b>	<b>P-AQAG0060HA</b>	<b>P-AQAG0070HA</b>	<b>P-AQAG0080HA</b>
Cooling capacity <sup>1)</sup>	kW		48,2	56,1	64,9	74,1
Input power <sup>1)</sup>	kW		15,0	19,0	21,6	25,0
EER <sup>1)</sup>			3,20	3,00	3,00	3,00
<b>SEER <sup>2)</sup></b>			<b>4,37</b>	<b>4,30</b>	<b>4,31</b>	<b>4,21</b>
$\eta_{s,c}$ <sup>2)</sup>	%		<b>171,9</b>	<b>168,9</b>	<b>169,4</b>	<b>165,4</b>
Heating capacity <sup>3)</sup>	kW		49,2	61,1	73,5	83,6
Input power <sup>3)</sup>	kW		15,6	18,6	21,7	24,9
COP <sup>3)</sup>			3,2	3,3	3,4	3,4
<b>SCOP <sup>4)</sup></b>			<b>3,67</b>	<b>3,75</b>	<b>3,87</b>	<b>3,84</b>
$\eta_{s,h}$ <sup>4)</sup>			<b>143,7</b>	<b>146,8</b>	<b>151,8</b>	<b>150,5</b>
<b>Energy efficiency class (SCOP) <sup>4)</sup></b>		<b>A+++ to D</b>	<b>A+</b>	<b>A+</b>	<b>A++</b>	<b>A++</b>
<b>SCOP<sub>MT</sub> <sup>4)</sup></b>			<b>3,11</b>	<b>3,14</b>	<b>3,26</b>	<b>3,22</b>
$\eta_{s,MT}$ <sup>4)</sup>			<b>121,4</b>	<b>122,7</b>	<b>127,3</b>	<b>126,0</b>
<b>Energy efficiency class (SCOP<sub>MT</sub>) <sup>4)</sup></b>		<b>A+++ to D</b>	<b>A+</b>	<b>A+</b>	<b>A++</b>	<b>A++</b>
Sound power (STD / S)	dB(A)		82,7 / 79,9	84,1 / 80,5	85,1 / 81,5	85,8 / 81,9
Sound pressure at 10 m (STD / S) <sup>5)</sup>	dB(A)		51,0 / 48,2	52,3 / 48,7	53,3 / 49,7	54,0 / 50,1

## Physical features

<b>ECOi-W AQUA-G BLUE 50-80 H EC fan - heat pump</b>			50	60	70	80
Dimension	Height	mm	1730	2011	2030	2030
	Length w/o / w water tank	mm	2215 / 2915 <sup>4)</sup>	2180 / 2680	2180 / 2680	2180 / 2680
	Width	mm	1032	1160	1160	1160
Operating weight		kg	538	603	628	669
<b>Refrigerant and compressors</b>						
Number of refrigerant circuits			1	1	1	1
Refrigerant (R290)		kg	4,50	4,80	5,30	6,80
GWP <sup>7)</sup>		CO <sub>2</sub> eq.	0,02	0,02	0,02	0,02
Compressors	Number / type		2 / Scroll	2 / Scroll	2 / Scroll	2 / Scroll
Capacity steps		%	50 / 100	40 / 60 / 100	40 / 60 / 100	50 / 100
<b>Water connections</b>						
Type of water connections			Male gas threaded	Male gas threaded	Male gas threaded	Male gas threaded
Water inlet/outlet diameter		Inch	1 ¼	2	2	2 ½
<b>Buffer tank (option)</b>						
Volume		l	200	300	300	300

1) According EN 14511-2013: chilled water inlet/outlet temperature: 12/7 °C, outdoor ambient temperature 35 °C DB. 2) According EN 14825 and following COMMISSION REGULATION (EU) 2016/2281.

3) According EN 14511-2013: warm water inlet/outlet temperature: 40/45 °C, outdoor ambient temperature 7 °C DB/6 °C WB. 4) According to EN 14825 and following COMMISSION REGULATION (EU) No 813/2013. 5) Sound pressures refer to ISO 3744 standard, parallelepiped shape. 6) Tank is external to the unit chassis. 7) Based on the Sixth Assessment Report (AR6) adopted by the Intergovernmental Panel on Climate Change (IPCC).

\* w/o: without, w: with.

### Accessories and options

Anti-vibration rubber mount / spring dampers  
Refrigerant gauges HP/LP  
Shut off valves  
Soft starter

### Accessories and options

Electrical heater for the water tank  
Variable or fixed speed pumps  
Water tank 200 L for sizes 50  
Water tank 300 L for sizes 60-70-80

### Accessories supplied loose

**P-375281** SRC - mini BMS controller  
**P-586595\_G** Cascade controller  
**P-372061\_G** Remote keyboard panel  
**P-372615\_G** Kit 4G modem  
**SVC-HYD-COMM-CLD1** 1-year pre-paid Cloud access

### Accessories supplied loose

**SVC-HYD-COMM-CLD3** 3-year pre-paid Cloud access  
**P-3721027** 3 way valve and probe for DHW management for size 50  
**P-3721028** 3 way valve and probe for DHW management for size 60-80  
**P-3721050** Kit temperature probe for deported tank





# ECOi-W AQUA 20-40 C/H/E - R410A

Air cooled chillers, heat pumps and condensing units.

Cooling capacity: 19,3 to 40,9 kW.

Heating capacity: 19,5 to 41,6 kW.



## The range at a glance

- 3 versions: C (chiller), H (heat pump) and E (condensing unit)
- SEER up to 4,59
- SCOP up to 3,40
- 5 sizes (4 sizes for E type)
- 2 configurations: STD (standard) and HPF (high pressure fan)

## Advantages

- Very high performance
- Low noise units
- Wide operating limits
- Easy maintenance: great accessibility to the internal components
- Low footprint
- Smart defrost technology: 1 defrost every 130 minutes for a constant LWT even at very low OAT (H type)
- Optimised for partial load operation
- 100% factory tested

## Operating limits

To be confirmed with AC SELECT:  
<https://acselect.panasonic.eu/>

Ambient temperature (chiller, heat pump and condensing unit).

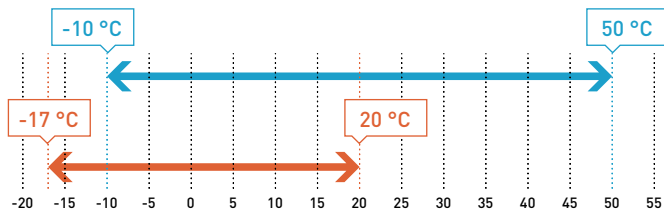

Leaving water temperature (chiller and heat pump).

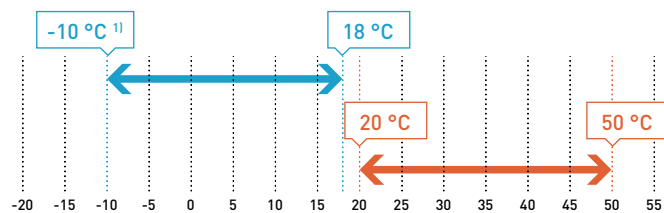

1) With glycol, 5 °C without glycol.

## Equipment

- 1 refrigerant circuit with tandem scroll compressors for a higher efficiency at partial load
- Stainless steel plate heat exchanger insulated with closed cell synthetic foam (C/H types)
- Finned coil condenser constructed with seamless copper tubes mechanically expanded into aluminium fins - Bluefin treatment for H type
- Hydraulic circuit without pump (C type) / without or with a fixed speed pump (H type)
- Super low noise units: acoustic box around the compressors
- Complete integrated control system with an external control panel that displays operating parameters and alarms
- Modbus RTU communication protocol as standard
- Night mode for energy savings and reduced sound levels
- Double water set point (H type)
- Water compensation curve control (C/H types)
- Return and leaving water temperature control (C/H types)
- Water filter and water flow switch (C/H types)
- Phase sequence monitor
- Suction and liquid line shut-off valves + a suction receiver (E type)

## AC SELECT.

Smart and user-friendly selection tool. Configure your air conditioning solution at required conditions:  
<https://acselect.panasonic.eu/>





## Technical performance

Power supply	Voltage	V	400	400	400	400	400
	Phase		Three phase	Three phase	Three phase	Three phase	Three phase
	Frequency	Hz	50	50	50	50	50
<b>Size</b>			<b>20</b>	<b>25</b>	<b>30</b>	<b>35</b>	<b>40</b>
<b>ECOi-W AQUA 20-40 C - chiller</b>			<b>P-AQAE0020CA</b>	<b>P-AQAE0025CA</b>	<b>P-AQAE0030CA</b>	<b>P-AQAE0035CA</b>	<b>P-AQAE0040CA</b>
Cooling capacity <sup>1)</sup>	kW	19,2	24,3	27,1	36,7	39,0	
Input power <sup>1)</sup>	kW	5,9	7,7	9,3	12,2	13,0	
EER <sup>1)</sup>		3,25	3,17	2,9	3,01	3,0	
<b>SEER <sup>2)3)</sup></b>		<b>4,78</b>	<b>4,38</b>	<b>4,43</b>	<b>4,43</b>	<b>4,48</b>	
$\eta_{s,c}$ <sup>2)3)</sup>		<b>188</b>	<b>172</b>	<b>174</b>	<b>174</b>	<b>176</b>	
Nominal water flow (in the evaporator)	m <sup>3</sup> /h	3,3	4,2	4,7	6,3	6,7	
Sound power (STD fan)	dB(A)	75	76	76	77	77	
Sound pressure at 10 m (STD fan) <sup>4)</sup>	dB(A)	42,8	43,8	43,8	44,8	44,8	
<b>ECOi-W AQUA 20-40 H - heat pump</b>			<b>P-AQAE0020HA</b>	<b>P-AQAE0025HA</b>	<b>P-AQAE0030HA</b>	<b>P-AQAE0035HA</b>	<b>P-AQAE0040HA</b>
Cooling capacity <sup>1)</sup>	kW	18,7	23,7	26,4	35,8	38,1	
Input power <sup>1)</sup>	kW	5,9	7,7	9,4	12,3	13,1	
EER <sup>1)</sup>		3,15	3,07	2,81	2,92	2,92	
<b>SEER <sup>2)</sup></b>		<b>4,68</b>	<b>4,31</b>	<b>4,28</b>	<b>4,25</b>	<b>4,33</b>	
$\eta_{s,c}$ <sup>2)</sup>		<b>184</b>	<b>169</b>	<b>168</b>	<b>167</b>	<b>170</b>	
Nominal water flow (in the evaporator)	m <sup>3</sup> /h	3,3	4,3	4,6	6,2	6,4	
Heating capacity <sup>5)</sup>	kW	19,5	26,9	29,7	37,3	41,6	
Input power <sup>5)</sup>	kW	6,1	9,3	9,9	13,2	13,5	
COP <sup>5)</sup>		3,19	2,90	2,99	2,82	3,08	
COP <sup>6)</sup>		4,17	4,10	4,10	4,11	3,86	
<b>SCOP <sup>2)7)</sup></b>		<b>3,50</b>	<b>3,38</b>	<b>3,45</b>	<b>3,50</b>	<b>3,50</b>	
<b>Energy efficiency class <sup>2)7)</sup></b>	<b>A+++ to D</b>	<b>A+</b>	<b>A+</b>	<b>A+</b>	<b>A+</b>	<b>A+</b>	
$\eta_{s,h}$ <sup>2)7)</sup>		<b>137</b>	<b>132</b>	<b>135</b>	<b>137</b>	<b>137</b>	
Nominal water flow (in the evaporator)	m <sup>3</sup> /h	3,4	4,7	5,2	6,5	7,2	
Sound power (STD fan)	dB(A)	75	76	76	77	77	
Sound pressure at 10 m (STD fan) <sup>4)</sup>	dB(A)	42,8	43,8	43,8	44,8	44,8	
<b>ECOi-W AQUA 25-40 E - condensing unit</b>			<b>P-AQAE0025EA</b>	<b>P-AQAE0030EA</b>	<b>P-AQAE0035EA</b>	<b>P-AQAE0040EA</b>	
Cooling capacity <sup>8)</sup>	kW	—	32,4	33,7	43,1	44,8	
Input power <sup>8)</sup>	kW	—	10,0	10,7	14,9	15,0	
EER <sup>8)</sup>		—	3,24	3,15	2,90	2,99	
Sound power	dB(A)	—	75	75	76	76	

## Physical features

<b>ECOi-W AQUA 20-40 C/H - chiller / heat pump</b>			<b>20</b>	<b>25</b>	<b>30</b>	<b>35</b>	<b>40</b>
Dimension	Height (STD / HPPF)	mm	1983 / 2025	1983 / 2025	1983 / 2025	1983 / 2025	1983 / 2025
	Width w/o / w water tank	mm	1000 / 1507	1000 / 1507	1000 / 1507	1000 / 1507	1000 / 1507
	Length	mm	1000	1000	1000	1000	1000
Operating weight without / with water tank - 1 pump	kg		285 / 450	295 / 460	325 / 490	335 / 500	335 / 500
<b>Water connections</b>							
Type of water connections (evaporator)			Male gas threaded BSPP ISO 228	Male gas threaded BSPP ISO 228	Male gas threaded BSPP ISO 228	Male gas threaded BSPP ISO 228	Male gas threaded BSPP ISO 228
Water inlet/outlet diameter	Inch		1 1/2	1 1/2	1 1/2	1 1/2	1 1/2
<b>ECOi-W AQUA 25-40 E - condensing unit</b>			<b>—</b>	<b>25</b>	<b>30</b>	<b>35</b>	<b>40</b>
Dimension	H x W x L	mm	—	1983 x 1000 x 1000	1983 x 1000 x 1000	1983 x 1000 x 1000	1983 x 1000 x 1000
Operating weight	kg		—	260	270	280	280
<b>Refrigerant connections</b>							
Liquid / suction line	Inch		— / —	5/8 / 1 1/8	5/8 / 1 1/8	5/8 / 1 1/8	5/8 / 1 1/8

1) According EN 14511-2013: chilled water inlet/outlet temperature: 12/7 °C, outdoor ambient temperature 35 °C DB. 2) According EN 14825. 3) ErP compliant: following COMMISSION REGULATION (EU) 2016/2281. 4) Sound pressures refer to ISO 3744 standard, parallelepiped shape. 5) According EN 14511-2013: warm water inlet/outlet temperature: 40/45 °C, outdoor ambient temperature 7 °C DB/6 °C WB. 6) According EN 14511-2013: warm water inlet/outlet temperature: 30/35 °C, outdoor ambient temperature 7 °C DB/6 °C WB. 7) ErP compliant: following COMMISSION REGULATION (EU) No 813/2013. 8) Data refers to 7 °C leaving chilled water temperature and 35 °C condenser air temperature, according EN 14511-2013 standard.

\* w/o: without, w: with.

Accessories and options	
Anti-vibration rubber mount / spring dampers	
BACnet IP or BACnet MSTP	
Fan speed control	
Finned coil blygold treatment (upon request) or epoxy	
High pressure fan (HPF)	

Accessories and options	
Modbus TCP/IP	
Outdoor coil protection grid	
Nordic pack (H type only)	
Shut off valves	
Soft starter	

Accessories and options	
Variable or fixed* speed pumps	
Water pressure switch	
Water tank 100 L	
Without neutral (upon request)	

\* Not available with ECOi-W AQUA C and ECOi-W AQUA H 20-30 due to Ecodesign compliance.

Accessories supplied loose	
<b>P-375281</b>	SRC - mini BMS controller
<b>P-372061</b>	Remote keyboard panel
<b>P-372615</b>	Kit 4G modem

Accessories supplied loose	
<b>SVC-HYD-COMM-CLD1</b>	1-year pre-paid Cloud access
<b>SVC-HYD-COMM-CLD3</b>	3-year pre-paid Cloud access
<b>P-378016</b>	Kit anti-vibration mount rubber





# ECOi-W AQUA 45-125 C/H/E - R410A

Air cooled chillers, heat pumps and condensing units.

Cooling capacity: 46,8 to 129,8 kW.

Heating capacity: 48,5 to 119,1 kW.



## Operating limits

To be confirmed with AC SELECT:  
<https://acselect.panasonic.eu/>

Ambient temperature (chiller, heat pump and condensing unit).

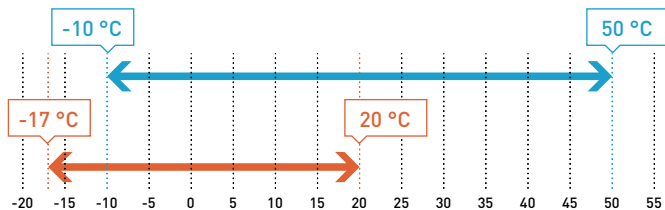

Leaving water temperature (chiller and heat pump).

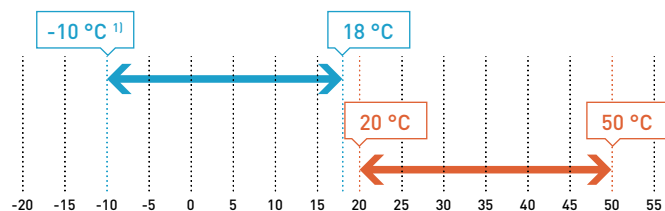

1) With glycol, 5 °C without glycol.

## The range at a glance

- 3 versions: C (chiller), H (heat pump) and E (condensing unit)
- 7 sizes
- SEER up to 4,41
- SCOP up to 3,43
- 2 configurations: STD (standard) and HPF (high pressure fan)
- 2 acoustic options: STD (standard) and S (super low noise)

## Advantages

- Very high performance
- Low noise units
- Wide operating limits
- Easy maintenance: great accessibility to the internal components
- Low footprint
- Smart defrost technology: 1 defrost every 130 minutes for a constant LWT even at very low OAT (H type)
- Optimised for partial load operation
- 100% factory tested

## Equipment

- 1 refrigerant circuit with tandem scroll compressors for a higher efficiency at partial load
- Stainless steel plate heat exchanger insulated with closed cell synthetic foam (C/H types)
- Finned coil condenser constructed with seamless copper tubes mechanically expanded into aluminium fins - Bluefin treatment for H type
- Hydraulic circuit without pump
- Complete integrated control system with an external control panel that displays the operating parameters and alarms
- Modbus RTU communication protocol as standard
- Night mode for energy savings and reduced sound levels
- Double water set point (H type)
- Water compensation curve control (C/H types)
- Return and leaving water temperature control (C/H types)
- Water filter and water flow switch (C/H types)
- Phase sequence monitor
- Suction and liquid line shut-off valves + a suction receiver (E type)

## AC SELECT.

Smart and user-friendly selection tool. Configure your air conditioning solution at required conditions:  
<https://acselect.panasonic.eu/>





Technical performance

	Voltage	V	400	400	400	400	400	400	400
Power supply	Phase		Three phase	Three phase	Three phase	Three phase	Three phase	Three phase	Three phase
	Frequency	Hz	50	50	50	50	50	50	50
	<b>Size</b>		<b>45</b>	<b>55</b>	<b>65</b>	<b>75</b>	<b>90</b>	<b>105</b>	<b>125</b>
<b>ECOi-W AQUA 45-125 C - chiller</b>			<b>P-AQAE0045CA</b>	<b>P-AQAE0055CA</b>	<b>P-AQAE0065CA</b>	<b>P-AQAE0075CA</b>	<b>P-AQAE0090CA</b>	<b>P-AQAE0105CA</b>	<b>P-AQAE0125CA</b>
Cooling capacity <sup>1)</sup>	kW		45,3	52,0	66,1	73,1	90,9	104,0	123,0
Input power <sup>1)</sup>	kW		15,4	17,6	21,7	24,0	30,7	34,9	40,6
EER <sup>1)</sup>			2,95	2,96	3,05	3,05	2,96	2,98	3,03
<b>SEER <sup>2)3)</sup></b>			<b>4,40</b>	<b>4,53</b>	<b>4,53</b>	<b>4,68</b>	<b>4,45</b>	<b>4,50</b>	<b>4,55</b>
$\eta_{s,c}$ <sup>2)3)</sup>			<b>173</b>	<b>178</b>	<b>178</b>	<b>184</b>	<b>175</b>	<b>177</b>	<b>179</b>
Nominal water flow (in the evaporator)	m <sup>3</sup> /h		7,8	8,9	11,4	12,6	15,6	17,9	21,2
Sound power (STD fan)	dB(A)		81	81	81	81	84	84	84
Sound pressure at 10 m (STD fan) <sup>4)</sup>	dB(A)		48,8	48,8	48,8	48,8	51,8	51,8	51,8
<b>ECOi-W AQUA 45-125 H - heat pump</b>			<b>P-AQAE0045HA</b>	<b>P-AQAE0055HA</b>	<b>P-AQAE0065HA</b>	<b>P-AQAE0075HA</b>	<b>P-AQAE0090HA</b>	<b>P-AQAE0105HA</b>	<b>P-AQAE0125HA</b>
Cooling capacity <sup>1)</sup>	kW		44,3	50,9	64,1	71,0	88,7	101,0	119,0
Input power <sup>1)</sup>	kW		15,9	18,0	21,8	24,0	30,6	34,8	40,4
EER <sup>1)</sup>			2,78	2,83	2,94	2,95	2,90	2,90	2,96
<b>SEER <sup>2)</sup></b>			<b>4,20</b>	<b>4,41</b>	<b>4,51</b>	<b>4,63</b>	<b>4,40</b>	<b>4,44</b>	<b>4,49</b>
$\eta_{s,c}$ <sup>2)</sup>			<b>165</b>	<b>174</b>	<b>177</b>	<b>182</b>	<b>173</b>	<b>175</b>	<b>177</b>
Nominal water flow (in the evaporator)	m <sup>3</sup> /h		8,0	9,2	11,3	12,3	15,7	18,2	20,9
Heating capacity <sup>5)</sup>	kW		48,5	58,2	67,3	76,0	88,2	101,0	119,0
Input power <sup>5)</sup>	kW		17,3	20,4	22,5	24,3	33,8	38,4	45,5
COP <sup>5)</sup>			2,80	2,86	2,99	3,12	2,61	2,63	2,62
COP <sup>6)</sup>			3,89	3,83	3,80	3,82	3,80	3,80	3,82
<b>SCOP <sup>2)7)</sup></b>			<b>3,38</b>	<b>3,38</b>	<b>3,55</b>	<b>3,53</b>	<b>3,40</b>	<b>3,43</b>	<b>3,43</b>
<b>Energy efficiency class <sup>2)7)</sup></b>		<b>A+++ to D</b>	<b>A+</b>	<b>A+</b>	<b>A+</b>	<b>A+</b>	—	—	—
$\eta_{s,h}$ <sup>2)7)</sup>			<b>132</b>	<b>132</b>	<b>139</b>	<b>138</b>	<b>133</b>	<b>134</b>	<b>134</b>
Nominal water flow (in the evaporator)	m <sup>3</sup> /h		8,4	10,2	11,7	13,2	15,3	17,6	20,7
Sound power (STD fan)	dB(A)		81	81	81	81	84	84	84
Sound pressure at 10 m (STD fan) <sup>4)</sup>	dB(A)		48,8	48,8	48,8	48,8	51,8	51,8	51,8
<b>ECOi-W AQUA 45-125 E - condensing unit</b>			<b>P-AQAE0045EA</b>	<b>P-AQAE0055EA</b>	<b>P-AQAE0065EA</b>	<b>P-AQAE0075EA</b>	<b>P-AQAE0090EA</b>	<b>P-AQAE0105EA</b>	<b>P-AQAE0125EA</b>
Cooling capacity <sup>8)</sup>	kW		57,4	64,5	72,4	79,3	104,0	120,0	136,0
Input power <sup>8)</sup>	kW		19,5	22,3	24,4	27,2	39,3	43,0	51,3
EER <sup>8)</sup>			2,94	2,89	2,97	2,91	2,65	2,79	2,66
Sound power	dB(A)		80	80	80	80	83	83	83

Physical features

<b>ECOi-W AQUA 45-125 C/H - chiller / heat pump</b>			<b>45</b>	<b>55</b>	<b>65</b>	<b>75</b>	<b>90</b>	<b>105</b>	<b>125</b>
Dimension	Height (STD / HPF)	mm	1986 / 2025	1986 / 2025	1986 / 2026	1986 / 2026	2286 / 2379	2286 / 2379	2286 / 2379
	Width	mm	1160	1160	1160	1160	1160	1160	1160
	Length w/o / w water tank	mm	2180 / 2680	2180 / 2680	2180 / 2680	2180 / 2680	2180 / 2680	2180 / 2680	2180 / 2680
Operating weight w/o / w water tank - 1 pump		kg	545 / 1010	545 / 1010	615 / 1080	615 / 1080	795 / 1260	905 / 1370	925 / 1390

Water connections

Type of water connections (evaporator)		Male gas threaded BSPP ISO 228	Male gas threaded BSPP ISO 228	Male gas threaded BSPP ISO 228	Male gas threaded BSPP ISO 228	Male gas threaded BSPP ISO 228	Male gas threaded BSPP ISO 228	Male gas threaded BSPP ISO 228	Male gas threaded BSPP ISO 228
Water inlet/outlet diameter	Inch	2	2	2	2	2½	2½	2½	2½
<b>ECOi-W AQUA 45-125 E - condensing unit</b>			<b>45</b>	<b>55</b>	<b>65</b>	<b>75</b>	<b>90</b>	<b>105</b>	<b>125</b>
Operating weight	kg		490	490	560	560	740	850	870
Dimension	H x W x L	mm	1986x1160x2180	1986x1160x2180	1986x1160x2180	1986x1160x2180	2286x1160x2180	2286x1160x2180	2286x1160x2180

Refrigerant connections

Liquid / suction line	Inch	5/8 / 1 5/8	5/8 / 1 5/8	5/8 / 1 5/8	5/8 / 1 5/8	7/8 / 1 5/8	7/8 / 1 5/8	7/8 / 1 5/8	7/8 / 1 5/8
-----------------------	------	-------------	-------------	-------------	-------------	-------------	-------------	-------------	-------------

1) According EN 14511-2013: chilled water inlet/outlet temperature: 12/7 °C, outdoor ambient temperature 35 °C DB. 2) According EN 14825. 3) ErP compliant: following COMMISSION REGULATION (EU) 2016/2281. 4) Sound pressures refer to ISO 3744 standard, parallelepiped shape. 5) According EN 14511-2013: warm water inlet/outlet temperature: 40/45 °C, outdoor ambient temperature 7 °C DB/6 °C WB. 6) According EN 14511-2013: warm water inlet/outlet temperature: 30/35 °C, outdoor ambient temperature 7 °C DB/6 °C WB. 7) ErP compliant: following COMMISSION REGULATION (EU) No 813/2013. 8) Data refers to 7 °C leaving chilled water temperature and 35 °C condenser air temperature, according EN 14511-2013 standard.

\* w/o: without, w: with.

Accessories and options

- Anti-vibration rubber mount / spring dampers
- BACnet IP or BACnet MSTP
- Desuperheater
- Fan speed control
- Finned coil blygold treatment (upon request) or epoxy
- Electrical heater high or low power (H type only)

Accessories and options

- Super low noise (S): acoustic box around the compressors
- High pressure fan (HPF)
- Modbus TCP/IP
- Outdoor coil protection grid
- Refrigerant gauges HP/LP

Accessories and options

- Shut off valves
- Soft starter
- Variable or fixed\* speed pumps
- Water tank 300 L
- Without neutral (upon request)
- Water pressure switch

\* Not available with ECOi-W AQUA C units due to Ecodesign compliance.

Accessories supplied loose

<b>P-375281</b>	SRC - mini BMS controller
<b>P-372061</b>	Remote keyboard panel
<b>P-372615</b>	Kit 4G modem

Accessories supplied loose

<b>SVC-HYD-COMM-CLD1</b>	1-year pre-paid Cloud access
<b>SVC-HYD-COMM-CLD3</b>	3-year pre-paid Cloud access





# ECOi-W AQUA 140-210 C/H - R410A

Air cooled chillers and heat pumps.

Cooling capacity: 125,4 to 208,8 kW.

Heating capacity: 143,7 to 217,6 kW.



## The range at a glance

- 2 versions: C (chiller) and H (heat pump)
- 5 sizes
- SEER up to 4,40
- SCOP up to 3,36

## Advantages

- Very high performances
- Low noise units
- Wide operating limits
- Easy maintenance: great accessibility to the internal components
- Low footprint
- Patented antifrost coil
- Smart defrost technology: 1 defrost every 130 minutes for a constant LWT even at very low OAT (H type)
- Optimised for partial load operation
- 100% factory tested

## Operating limits

To be confirmed with AC SELECT:  
<https://acselect.panasonic.eu/>

Ambient temperature (chiller and heat pump).

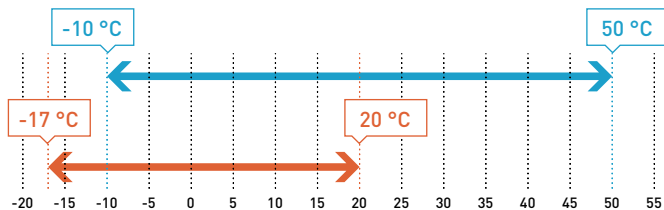

Leaving water temperature (chiller and heat pump).

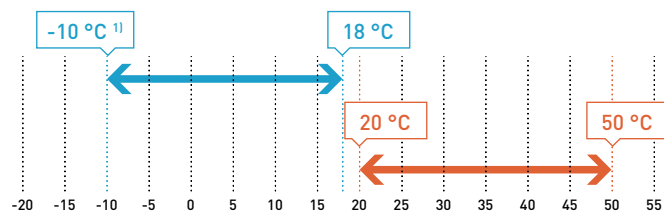

1) With glycol, 5 °C without glycol.

## Equipment

- 2 refrigerant circuits, each equipped with tandem scroll compressors for a higher efficiency at partial load
- Stainless steel plate heat exchanger insulated with closed cell synthetic foam
- Finned coil condenser constructed with seamless copper tubes mechanically expanded into aluminium fins - Bluefin treatment for H type
- Hydraulic circuit without pump
- Complete integrated control system with an external control panel that displays the operating parameters and alarms
- Modbus RTU communication protocol as standard
- Super low noise units: acoustic box around the compressors
- Patented antifrost coil (H type)
- Night mode for energy savings and reduced sound levels
- Double water set point (H type)
- Water compensation curve control
- Return and leaving water temperature control
- Water filter and water flow switch
- Phase sequence monitor

## AC SELECT.

Smart and user-friendly selection tool. Configure your air conditioning solution at required conditions:  
<https://acselect.panasonic.eu/>





## Technical performance

	Voltage	V	400	400	400	400	400
Power supply	Phase		Three phase	Three phase	Three phase	Three phase	Three phase
	Frequency	Hz	50	50	50	50	50
	<b>Size</b>		<b>140</b>	<b>150</b>	<b>170</b>	<b>190</b>	<b>210</b>
<b>ECOi-W AQUA 140-210 C - chiller</b>			<b>P-AQAE0140CA</b>	<b>P-AQAE0150CA</b>	<b>P-AQAE0170CA</b>	<b>P-AQAE0190CA</b>	<b>P-AQAE0210CA</b>
Cooling capacity <sup>1)</sup>	kW	132	146	164	181	208	
Input power <sup>1)</sup>	kW	43,1	47,6	54,8	61,1	69,8	
EER <sup>1)</sup>		3,06	3,07	2,99	2,96	2,98	
<b>SEER <sup>2)3)</sup></b>		<b>4,40</b>	<b>4,45</b>	<b>4,38</b>	<b>4,40</b>	<b>4,25</b>	
<b><math>\eta_{s,c}</math> <sup>2)3)</sup></b>		<b>173</b>	<b>175</b>	<b>172</b>	<b>173</b>	<b>167</b>	
Nominal water flow (in the evaporator)	m <sup>3</sup> /h	22,7	25,1	28,2	31,1	35,8	
Sound power (STD fan)	dB(A)	85	85	87	88	88	
Sound pressure at 10 m (STD fan) <sup>4)</sup>	dB(A)	53,4	53,4	55,0	56,1	56,1	
<b>ECOi-W AQUA 140-210 H - heat pump</b>			<b>P-AQAE0140HA</b>	<b>P-AQAE0150HA</b>	<b>P-AQAE0170HA</b>	<b>P-AQAE0190HA</b>	<b>P-AQAE0210HA</b>
Cooling capacity <sup>1)</sup>	kW	128	142	164	178	208	
Input power <sup>1)</sup>	kW	43,2	47,7	54,7	61,3	69,7	
EER <sup>1)</sup>		2,97	2,98	3,00	2,90	2,98	
<b>SEER <sup>2)</sup></b>		<b>4,39</b>	<b>4,36</b>	<b>4,31</b>	<b>4,23</b>	<b>4,28</b>	
<b><math>\eta_{s,c}</math> <sup>2)</sup></b>		<b>173</b>	<b>171</b>	<b>169</b>	<b>166</b>	<b>168</b>	
Nominal water flow (in the evaporator)	m <sup>3</sup> /h	21,6	23,7	25,9	30,2	33,7	
Heating capacity <sup>5)</sup>	kW	144	154	170	195	218	
Input power <sup>5)</sup>	kW	45,8	50,2	55,4	67,5	78,3	
COP <sup>5)</sup>		3,14	3,06	3,07	2,89	2,78	
COP <sup>6)</sup>		3,84	3,82	3,81	3,82	3,82	
<b>SCOP <sup>2)7)</sup></b>		<b>3,30</b>	<b>3,33</b>	<b>3,30</b>	<b>3,28</b>	<b>3,23</b>	
<b><math>\eta_{s,h}</math> <sup>2)7)</sup></b>		<b>129</b>	<b>130</b>	<b>129</b>	<b>128</b>	<b>126</b>	
Nominal water flow (in the evaporator)	m <sup>3</sup> /h	24,8	26,5	29,6	33,9	37,9	
Sound power	dB(A)	85	85	87	88	88	
Sound pressure at 10 m (STD fan) <sup>4)</sup>	dB(A)	53,4	53,4	55	56,1	56,1	

## Physical features

<b>ECOi-W AQUA 140-210 C/H - chiller / heat pump</b>			<b>140</b>	<b>150</b>	<b>170</b>	<b>190</b>	<b>210</b>
Dimension	Height	mm	2295	2295	2321	2321	2321
	Width	mm	2210	2210	2210	2210	2210
	Length w/o / w water tank	mm	2856 / 3666	2856 / 3666	2856 / 3666	2856 / 3666	2856 / 3666
Operating weight w/o / w water tank - 1 pump	kg	1685 / 2139	1705 / 2159	1798 / 2253	1891 / 2343	2201 / 2653	
<b>Water connections</b>							
Type of water connections (evaporator)			Victaulic®	Victaulic®	Victaulic®	Victaulic®	Victaulic®
Water inlet/outlet diameter	Inch		2 ½	2 ½	2 ½	2 ½	2 ½

1) According EN 14511-2013: chilled water inlet/outlet temperature: 12/7 °C, outdoor ambient temperature 35 °C DB. 2) According EN 14825. 3) ErP compliant: following COMMISSION REGULATION (EU) 2016/2281. 4) Sound pressures refer to ISO 3744 standard, parallelepiped shape. 5) According EN 14511-2013: warm water inlet/outlet temperature: 40/45 °C, outdoor ambient temperature 7 °C DB/6 °C WB. 6) According EN 14511-2013: warm water inlet/outlet temperature: 30/35 °C, outdoor ambient temperature 7 °C DB/6 °C WB. 7) ErP compliant: following COMMISSION REGULATION (EU) No 813/2013.

\* w/o: without, w: with.

### Accessories and options

Anti-vibration rubber mount / spring dampers  
BACnet IP and BACnet MSTP  
Desuperheater (upon request)  
Fan speed control  
Finned coil blygold treatment (upon request) and epoxy

### Accessories and options

Hydraulic gauges  
Modbus TCP/IP  
Outdoor coil protection grid  
Nordic pack (H type only)  
Refrigerant gauges HP/LP  
Shut off valves

### Accessories and options

Soft starter  
Variable or fixed\* speed pumps  
Water tank 300 L  
Without neutral  
Water pressure switch

\* ECOi-W AQUA C units can't be Ecodesign compliant with this option.

### Accessories supplied loose

**P-375281** SRC - mini BMS controller  
**P-372061** Remote keyboard panel  
**P-372615** Kit 4G modem

### Accessories supplied loose

**SVC-HYD-COMM-CLD1** 1-year pre-paid Cloud access  
**SVC-HYD-COMM-CLD3** 3-year pre-paid Cloud access  
**P-372614** Victaulic® to threaded pipe connection





# ECOi-W AQUA-Z 50-170 C/H - R32

Air cooled chillers and heat pumps.

Cooling capacity: 51,6 to 173,0 kW.

Heating capacity: 51,7 to 180,0 kW.

R32  
REFRIGERANT



## The range at a glance

- 2 versions: C (chiller) and H (heat pump)
- 10 sizes
- SEER up to 4,88 (STD AC) / 5,31 (STD EC)
- SCOP up to 3,72 (STD AC) / 4,10 (STD EC)
- 2 configurations: STD (standard) and HPF (high pressure fan)
- 2 fan types: AC (standard fan) and EC (high efficiency fan)
- 2 acoustic options: STD (standard) and S (super low noise)

## Advantages

- Low GWP R32 refrigerant (GWP= 675)
- Very high efficiency
- Wide operating limits
- Low footprint: one of the smallest footprint on the market with only 2,53 m<sup>2</sup> for sizes 50-130 and 4,36 m<sup>2</sup> for sizes 150-170
- Reduced sound levels: S version (super low noise) with EC fan and compressor sound jackets
- New advanced control system
- Easy maintenance: great accessibility to the internal components
- Cascade controller available for multi system operation
- SG Ready
- 100% factory tested

## Operating limits

To be confirmed with AC SELECT:

<https://acselect.panasonic.eu/>

Ambient temperature.

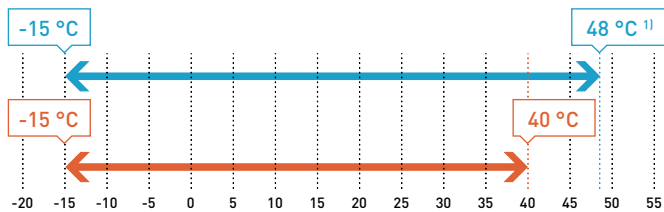

Leaving water temperature.

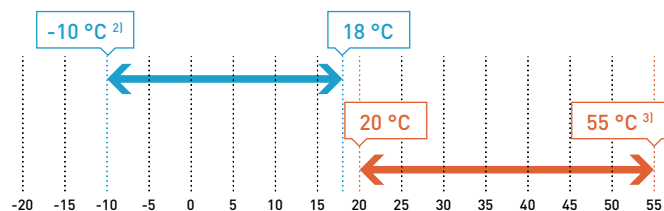

1) 47 °C for sizes 150-170.

2) With glycol, 5 °C without glycol.

3) 53 °C for sizes 150-170.

## Equipment

- 1 refrigerant circuit with tandem scroll compressors for a higher efficiency at partial load
- Stainless steel plate heat exchanger insulated with closed cell synthetic foam
- Finned coil condenser constructed with seamless copper tubes mechanically expanded into aluminium fins - Bluefin treatment for H type
- Hydraulic circuit without pump
- Complete integrated control system with an external control panel that displays the operating parameters and alarms
- Modbus RTU, Modbus TCP/IP, BACnet MSTP or BACnet IP
- Night mode for energy savings and reduced sound levels
- Electronic expansion valve
- Water compensation curve control
- Return and leaving water temperature control
- External switch (cooling/heating, night mode, load shedding)
- Water filter and water flow switch
- Phase sequence monitor
- Without neutral

## AC SELECT.

Smart and user-friendly selection tool. Configure your air conditioning solution at required conditions:

<https://acselect.panasonic.eu/>







Technical performance

	Voltage	V	400	400	400	400	400	400	400	400	400	400
Power supply	Phase		Three phase	Three phase	Three phase	Three phase	Three phase	Three phase	Three phase	Three phase	Three phase	Three phase
	Frequency	Hz	50	50	50	50	50	50	50	50	50	50
Size			<b>50</b>	<b>60</b>	<b>70</b>	<b>75</b>	<b>85</b>	<b>100</b>	<b>115</b>	<b>130</b>	<b>150</b>	<b>170</b>
<b>ECOi-W AQUA-Z 50-170 C - chiller</b>	<b>P-AQAZ****CA</b>	<b>0050</b>	<b>0060</b>	<b>0070</b>	<b>0075</b>	<b>0085</b>	<b>0100</b>	<b>0115</b>	<b>0130</b>	<b>0150</b>	<b>0170</b>	
Cooling capacity <sup>1)</sup>	kW	51,6	57,6	69,7	78,2	82,8	100	116	126	154	173	
Input power <sup>1)</sup>	kW	16,5	19,6	22,4	24	26,8	31,4	37,4	42,3	47,4	55,7	
EER (STD AC / STD EC) <sup>*1)</sup>		3,13/3,25	2,94/3,03	3,11/3,29	3,26/3,41	3,09/3,23	3,18/3,30	3,10/3,20	2,98/3,07	3,25/3,38	3,11/3,20	
<b>SEER (STD AC / STD EC) <sup>*2)3)</sup></b>		<b>4,60/5,05</b>	<b>4,59/5,02</b>	<b>4,61/5,31</b>	<b>4,72/5,29</b>	<b>4,45/4,96</b>	<b>4,88/5,19</b>	<b>4,59/5,01</b>	<b>4,43/4,71</b>	<b>4,70/5,22</b>	<b>4,68/5,16</b>	
$\eta_{s,c}$ (STD AC / STD EC) <sup>*2)3)</sup>		<b>180,9 / 198,9</b>	<b>180,5 / 197,8</b>	<b>181,3 / 209,6</b>	<b>185,6 / 208,7</b>	<b>175,0 / 195,6</b>	<b>192,3 / 204,9</b>	<b>180,5 / 197,3</b>	<b>174,2 / 185,6</b>	<b>184,8 / 205,6</b>	<b>184,2 / 203,2</b>	
Nominal water flow (in the evaporator)	m <sup>3</sup> /h	9,2	10,6	12,2	13,2	14,7	17,9	21,1	23,5	27,2	30,7	
Sound power (STD AC / S) *	dB(A)	83 / 81	84 / 81	81 / 78	81 / 78	84 / 82	86 / 83	87 / 84	87 / 84	89 / 86	91 / 88	
Sound pressure at 10 m (STD AC / S) <sup>*4)</sup>	dB(A)	51 / 49	52 / 49	50 / 47	49 / 46	52 / 50	54 / 51	55 / 52	55 / 53	57 / 54	59 / 56	
<b>ECOi-W AQUA-Z 50-170 H - heat pump</b>	<b>P-AQAZ****HA</b>	<b>0050</b>	<b>0060</b>	<b>0070</b>	<b>0075</b>	<b>0085</b>	<b>0100</b>	<b>0115</b>	<b>0130</b>	<b>0150</b>	<b>0170</b>	
Cooling capacity <sup>1)</sup>	kW	51,1	57	69	77,4	82	99,3	115	125	152	170	
Input power <sup>1)</sup>	kW	16,7	19,8	22,6	24,3	27,1	31,8	37,7	42,7	47,9	57,1	
EER (STD AC / STD EC) <sup>*1)</sup>		3,06/3,17	2,88/2,97	3,05/3,22	3,19/3,35	3,03/3,17	3,12/3,25	3,05/3,14	2,93/3,00	3,17/3,30	2,98/3,07	
EER (STD AC / STD EC) <sup>*5)</sup>		3,53/3,67	3,40/3,50	3,57/3,64	3,78/3,96	3,52/3,66	3,63/3,76	3,51/3,54	3,39/3,50	3,63/3,76	3,39/3,56	
<b>SEER (STD AC / STD EC) <sup>*2)</sup></b>		<b>4,46/4,83</b>	<b>4,42/4,50</b>	<b>4,51/5,04</b>	<b>4,61/4,99</b>	<b>4,33/4,80</b>	<b>4,77/4,93</b>	<b>4,44/4,82</b>	<b>4,23/4,51</b>	<b>4,59/5,04</b>	<b>4,49/4,92</b>	
$\eta_{s,c}$ (STD AC / STD EC) <sup>*2)</sup>		<b>175,2 / 190,2</b>	<b>173,6 / 176,9</b>	<b>177,5 / 198,8</b>	<b>181,5 / 196,7</b>	<b>170,3 / 188,9</b>	<b>187,7 / 194,1</b>	<b>174,6 / 190,0</b>	<b>166 / 177,2</b>	<b>180,5 / 198,7</b>	<b>176,6 / 193,8</b>	
Nominal water flow (in the evaporator)	m <sup>3</sup> /h	8,7	10,6	12,2	13,2	14,7	17,9	21,1	23,5	27,2	30,7	
Heating capacity <sup>6)</sup>	kW	51,7	59,7	71,8	78,5	86,5	107,6	122,3	137,5	159,1	180,1	
Input power <sup>6)</sup>	kW	16,5	19,3	22,1	24,2	27,2	32,5	37,0	41,0	48,2	54,5	
COP (STD AC / STD EC) <sup>*4)</sup>		3,12/3,27	3,10/3,21	3,24/3,43	3,24/3,41	3,19/3,30	3,31/3,45	3,31/3,42	3,36/3,42	3,30/3,48	3,31/3,40	
COP (STD AC / STD EC) <sup>*7)</sup>		3,81/4,00	3,80/3,92	3,92/4,21	3,91/4,16	3,92/4,16	3,99/4,19	4,10/4,26	4,04/4,12	4,07/4,31	4,02/4,16	
<b>SCOP (STD AC / STD EC) <sup>*2)8)</sup></b>		<b>3,53/3,90</b>	<b>3,54/3,94</b>	<b>3,47/3,71</b>	<b>3,65/3,80</b>	<b>3,60/4,02</b>	<b>3,64/4,10</b>	<b>3,66/4,02</b>	<b>3,72/3,97</b>	<b>3,57/4,04</b>	<b>3,60/3,95</b>	
Energy efficiency class (STD AC / STD EC) <sup>*2)7)</sup>	A+++ to D	A+ / A+	A+ / A+	A+ / A++	A+ / A++	A+ / A++	- / -	- / -	- / -	- / -	- / -	
$\eta_{s,h}$ (STD AC / STD EC) <sup>*2)7)</sup>		<b>138,0 / 152,8</b>	<b>138,5 / 154,5</b>	<b>135,6 / 145,3</b>	<b>143,2 / 148,8</b>	<b>141,2 / 157,8</b>	<b>142,5 / 160,9</b>	<b>143,2 / 157,9</b>	<b>145,7 / 155,9</b>	<b>139,9 / 158,4</b>	<b>140,9 / 155,2</b>	
Nominal water flow (in the evaporator)	m <sup>3</sup> /h	9,3	10,7	12,5	13,9	15,0	18,3	21,5	23,9	27,5	31,7	
Sound power (STD AC / S) *	dB(A)	83 / 81	84 / 81	81 / 78	81 / 78	84 / 82	86 / 83	87 / 84	87 / 84	89 / 86	91 / 88	
Sound pressure at 10 m (STD AC / S) <sup>*4)</sup>	dB(A)	51 / 49	52 / 49	50 / 47	50 / 46	52 / 50	54 / 51	55 / 52	56 / 53	57 / 54	59 / 56	

Physical features

ECOi-W AQUA-Z 50-170 C/H - chiller / heat pump		50	60	70	75	85	100	115	130	150	170
Dimension	Height (STD / EC/HPF)	1986/2034	1986/2034	1986/2034	1986/2034	2286/2334	2286/2334	2286/2334	2286/2334	2285/2333	2285/2333
	Width	1160	1160	1160	1160	1160	1160	1160	1160	1151	1151
	Length without water tank	2180	2180	2180	2180	2180	2180	2180	2180	3789	3789
Operating weight without water tank - 1 pump	kg	527	547	621	637	701	731	813	815	1265	1279
<b>Water connections</b>											
Type of water connections (evaporator)		Male gas threaded BSPP ISO 228	Male gas threaded BSPP ISO 228	Male gas threaded BSPP ISO 228	Male gas threaded BSPP ISO 228	Male gas threaded BSPP ISO 228	Male gas threaded BSPP ISO 228	Male gas threaded BSPP ISO 228	Male gas threaded BSPP ISO 228	Male gas threaded BSPP ISO 228	Male gas threaded BSPP ISO 228
Water inlet/outlet diameter	Inch	2	2	2	2	2 1/2	2 1/2	2 1/2	2 1/2	2 1/2	2 1/2

1) According EN 14511-2018: chilled water inlet/outlet temperature: 12/7 °C, outdoor ambient temperature 35 °C DB. 2) According EN 14825. 3) ErP compliant: following COMMISSION REGULATION (EU) 2016/2281. 4) Sound pressures refer to ISO 3744 standard, parallelepiped shape. 5) According EN 14511-2018: chilled water inlet/outlet temperature: 23/18 °C, outdoor ambient temperature 35 °C DB. 6) According EN 14511-2018: warm water inlet/outlet temperature: 40/45 °C, outdoor ambient temperature 7 °C DB/6 °C WB. 7) According EN 14511-2018: warm water inlet/outlet temperature: 30/35 °C, outdoor ambient temperature 7 °C DB/6 °C WB. 8) ErP compliant: following COMMISSION REGULATION (EU) No 813/2013.

\* STD AC: standard version with AC fan, STD EC: standard version with high efficiency EC fan, S: super low noise version with high efficiency EC fan + compressor sound jackets.

Accessories and options
Anti-vibration rubber mount / spring dampers *
Compressor jackets (standard for S versions)
Desuperheater
Electrical heater for the water tank
Fin&Tube Al/Cu with epoxy / Blygold treatment
High efficiency EC fan

Accessories and options
High pressure fan (HPF)
Outdoor coil protection grid
Power factor corrector capacitors
Refrigerant gauges HP/LP
Shut off valves
Soft starter

Accessories and options
Variable speed pumps
Water pressure switch *
Water tank 300 L
Without neutral
Communication protocols: Modbus RTU (Std.), Modbus TCP/IP, BACnet MSTP, BACnet IP

\* Field-installed accessories. All other accessories are factory-installed.

Accessories supplied loose
<b>P-375281</b> SRC - mini BMS controller
<b>P-586595</b> Cascade controller
<b>P-372061</b> Remote keyboard panel

Accessories supplied loose
<b>P-372615</b> Kit 4G modem
<b>SVC-HYD-COMM-CLD1</b> 1-year pre-paid Cloud access
<b>SVC-HYD-COMM-CLD3</b> 3-year pre-paid Cloud access





# ECOi-W AQUA-Z DC 150-380 C/H · R32

Air cooled chillers and heat pumps.

Cooling capacity: 151 to 377 kW.

Heating capacity: 154 to 384 kW.

R32  
REFRIGERANT



## Operating limits

To be confirmed with AC SELECT:  
<https://acselect.panasonic.eu/>

### Ambient temperature.

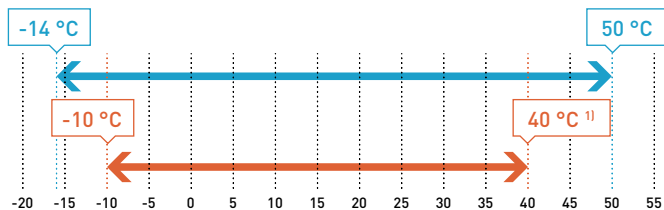

### Leaving water temperature.

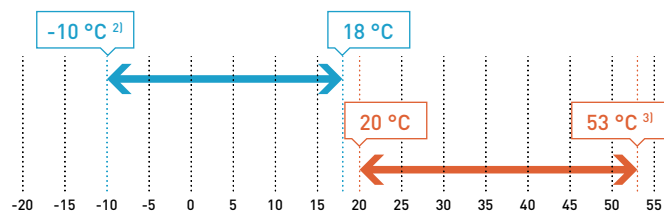

1) With EC fans.

2) With glycol, 5 °C without glycol.

3) 55 °C sizes 150-170.

## The range at a glance

- 2 versions: C (chiller) and H (heat pump)
- 10 sizes for C version and 13 sizes for H version
- 3 different chassis
- SEER up to 4,93 (STD AC) / 5,23 (STD EC)
- SCOP up to 3,90 (STD AC) / 4,00 (STD EC)
- 2 configurations: STD (standard) and HPF (high pressure fan)
- 2 fan types: AC (standard fan) and EC (high efficiency fan)
- 2 acoustic options: STD (standard) and S (super low noise)

## Advantages

- Low GWP R32 refrigerant (GWP= 675)
- Double circuit units able to work in partial load from around 20% of total capacity
- Very high efficiency
- Wide operating limits
- Reduced sound levels: S version (super low noise) with EC fan and compressor sound jackets for sizes 150-380, additional compressor box for sizes 190-380
- New intelligent control logic
- Easy maintenance: great accessibility to the internal components
- Cascade controller available for multi system operation with capacity boost up to 3040 kW
- SG Ready
- 100% factory tested

## Equipment

- 2 refrigerant circuits with tandem scroll compressors for a higher efficiency at partial load
- Stainless steel plate heat exchanger insulated with closed cell synthetic foam
- Microchannel coils only for C version (sizes 190-380)
- Fin&Tube coil condenser constructed with seamless copper tubes mechanically expanded into aluminium fins - Bluefin treatment for H version
- Hydraulic circuit without pump
- Complete integrated control system with an external control panel that displays the operating parameters and alarms
- Modbus RTU, Modbus TCP/IP, BACnet MSTP or BACnet IP
- Digital input for Night Mode, Demand mode or Eco Mode for energy savings and reduced sound levels
- Electronic expansion valve
- Water compensation curve control
- Return and leaving water temperature control
- Water flow switch (sizes 150-170)
- Differential pressure switch (sizes 190-380)
- Phase sequence monitor
- Automatic circuit breaker
- Without neutral



Technical performance

Size		150	170	190	210	230	260	290	320	350	380			
<b>ECOi-W AQUA-Z DC 150-380 C - chiller</b>	<b>P-AQADZ****CA</b>	<b>STD AC / STD EC</b>	<b>STD AC / STD EC</b>	<b>STD AC / STD EC</b>	<b>STD AC / STD EC</b>	<b>STD AC / STD EC</b>	<b>STD AC / STD EC</b>	<b>STD AC / STD EC</b>	<b>STD AC / STD EC</b>	<b>STD AC / STD EC</b>	<b>STD AC / STD EC</b>			
Cooling capacity <sup>1)</sup>	kW	151,0/151,0	170,0/170,0	189,0/189,0	212,0/214,0	229,0/229,0	260,0/260,0	307,0/307,0	326,0/325,0	346,0/347,0	377,0/377,0			
Input power <sup>1)</sup>	kW	49,7/49,0	56,7/55,9	59,4/57,3	69,1/66,5	75,1/72,7	90,0/87,8	95,9/92,5	104,2/100,0	112,0/108,1	126,9/122,8			
EER <sup>1)</sup>		3,04/3,08	3,00/3,04	3,18/3,30	3,07/3,22	3,05/3,15	2,89/2,96	3,20/3,32	3,13/3,25	3,09/3,21	3,0/3,1			
<b>SEER <sup>2)</sup></b>		<b>4,93/5,2</b>	<b>4,90/5,15</b>	<b>4,68/5,23</b>	<b>4,62/5,20</b>	<b>4,48/4,90</b>	<b>4,40/4,79</b>	<b>4,63/5,13</b>	<b>4,33/5,12</b>	<b>4,43/4,79</b>	<b>4,35/4,8</b>			
$\eta_{s,c}$ <sup>2)</sup>	%	<b>194,0/204,0</b>	<b>192,8/203,0</b>	<b>184,3/206,1</b>	<b>181,8/204,8</b>	<b>176,3/192,9</b>	<b>173,1/188,4</b>	<b>182,0/202,2</b>	<b>170,0/188,8</b>	<b>174,2/188,5</b>	<b>171,0/188,8</b>			
Cooling capacity (A 35 °C, W 23/18 °C)	kW	191,0/193,0	213,0/217,0	242,0/243,0	269,0/271,0	294,0/295,0	331,0/339,7	389,0/390,0	415,0/412,0	442,0/444,0	483,0/484,0			
Input power (A 35 °C, W 23/18 °C)	kW	53,8/52,7	62,1/61,2	64,2/61,3	74,5/71,6	82,9/79,9	98,2/96,8	103,0/99,4	112,0/109,0	123,0/119,0	139,0/136,0			
Water flow	m <sup>3</sup> /h	26,0/25,9	29,2/29,2	32,5/32,5	36,5/36,8	39,4/39,4	44,7/44,7	52,8/52,8	56,1/55,9	59,5/59,7	64,8/64,8			
Sound power [STD]	dB(A)	89,6/89,0	90,4/89,9	91,1/90,9	91,5/91,3	92,0/91,9	92,4/92,3	93,3/93,1	94,3/94,2	95,2/95,1	95,4/95,3			
Sound pressure [STD] *	dB(A)	57,5/56,9	58,3/57,8	59,0/58,8	59,4/59,2	59,9/59,8	60,3/60,2	61,1/60,9	62,1/62,0	63,0/62,9	63,2/63,1			
Sound power [S]	dB(A)	-/85,0	-/85,4	-/87,2	-/87,4	-/87,6	-/87,8	-/88,6	-/89,7	-/90,1	-/90,3			
Sound pressure [S] *	dB(A)	-/52,9	-/53,3	-/55,1	-/55,3	-/55,5	-/55,7	-/56,4	-/57,5	-/57,9	-/58,1			
Size		150	170	190	210	220	230	260	270	290	300	320	350	380
<b>ECOi-W AQUA-Z DC 150-380 H - heat pump</b>	<b>P-AQADZ****HA</b>	<b>STD AC / STD EC</b>	<b>STD AC / STD EC</b>	<b>STD AC / STD EC</b>	<b>STD AC / STD EC</b>	<b>STD AC / STD EC</b>	<b>STD AC / STD EC</b>	<b>STD AC / STD EC</b>	<b>STD AC / STD EC</b>	<b>STD AC / STD EC</b>	<b>STD AC / STD EC</b>	<b>STD AC / STD EC</b>	<b>STD AC / STD EC</b>	<b>STD AC / STD EC</b>
Cooling capacity <sup>1)</sup>	kW	150/150	167/167	184/183	204/204	208	224/224	251/251	265	291,1/289,3	295	307,7/310,7	330/331	364/364,3
Input power <sup>1)</sup>	kW	49,7/49,0	56,6/55,9	62,0/59,6	72,1/69,9	67,3	76,7/74,4	93,0/90,6	83,1	101,3/96,6	93,1	107,5/103,3	114,2/110,0	131,7/128,1
Total EER <sup>1)</sup>		3,02/3,06	2,95/2,99	2,97/3,07	2,83/2,92	3,09	2,92/3,01	2,7/2,77	3,19	2,87/2,99	3,17	2,86/3,00	2,89/3,01	2,76/2,84
Total EER (A 35 °C, W 23/18 °C)		3,53/3,60	3,41/3,51	3,41/3,58	3,22/3,37	3,63	3,45/3,60	3,12/3,18	3,83	3,32/3,46	3,72	3,31/3,52	3,32/3,52	3,16/3,30
<b>SEER <sup>2)</sup></b>		<b>4,75/5,03</b>	<b>4,71/4,97</b>	<b>4,45/4,94</b>	<b>4,39/4,82</b>	<b>5,03</b>	<b>4,34/4,71</b>	<b>4,21/4,55</b>	<b>5,01</b>	<b>4,34/4,83</b>	<b>5,01</b>	<b>4,33/4,89</b>	<b>4,40/4,79</b>	<b>4,34/4,65</b>
$\eta_{s,c}$ <sup>2)</sup>	%	<b>187,1 / 198,1</b>	<b>185,3 / 195,7</b>	<b>175,2 / 194,6</b>	<b>172,5 / 189,6</b>	<b>198</b>	<b>170,6 / 185,5</b>	<b>165,5 / 179,1</b>	<b>197,5</b>	<b>170,4 / 190,1</b>	<b>197,3</b>	<b>170 / 192,4</b>	<b>172,9 / 188,5</b>	<b>170,5 / 182,9</b>
Water flow	m <sup>3</sup> /h	25,8/25,8	28,7/28,7	31,6/31,5	35,1/35,1	35,8	38,5/38,5	43,2/43,2	45,6	50,1/49,8	50,7	52,9/53,4	56,8/56,9	62,6/62,7
Heating capacity <sup>3)</sup>	kW	154/154	178/179	190/190	201/201	219	241/241	256,9/258,5	288	285,6/284,8	312	301,3/316,5	337/340	384/384,5
Input power <sup>3)</sup>	kW	48,8/48,2	54,9/54,4	61,3/58,6	68,5/65,9	67	75,4/72	87,6/85,0	88,3	97,5/93,2	94,6	103,2/100,1	111/107	128/122,4
Total COP <sup>3)</sup>		3,16/3,20	3,24/3,29	3,10/3,24	2,93/3,05	3,27	3,20/3,35	2,93/3,04	3,26	2,93/3,05	3,30	2,92/3,16	3,04/3,18	3,00/3,14
Total COP (A 7 °C, W 30/35 °C)		3,67/3,82	3,98/4,04	3,57/3,80	3,43/3,59	4,01	3,86/4,04	3,56/3,68	4,00	3,47/3,61	3,86	3,45/3,86	3,69/3,82	3,54/3,66
<b>SCOP <sup>4)</sup></b>		<b>3,83/4,00</b>	<b>3,90/4,00</b>	<b>3,46/3,89</b>	<b>3,44/3,90</b>	<b>3,86</b>	<b>3,64/3,99</b>	<b>3,52/3,85</b>	<b>3,82</b>	<b>3,51/3,91</b>	<b>3,92</b>	<b>3,50/3,85</b>	<b>3,50/3,87</b>	<b>3,66/3,95</b>
$\eta_{s,h}$ <sup>4)</sup>	%	<b>150 / 157,1</b>	<b>152,8 / 156,8</b>	<b>135,6 / 152,7</b>	<b>134,7 / 152,8</b>	<b>151,3</b>	<b>142,5 / 156,4</b>	<b>137,9 / 151</b>	<b>149,7</b>	<b>137,4 / 153,2</b>	<b>153,7</b>	<b>137 / 151,2</b>	<b>136,9 / 151,9</b>	<b>143,4 / 155,1</b>
Water flow	m <sup>3</sup> /h	26,5/26,5	30,6/30,8	32,7/32,7	34,6/34,6	37,7	41,5/41,5	44,2/44,5	49,5	49,1/49,0	53,7	51,8/54,4	58,0/58,5	66,0/66,1
Sound power [STD]	dB(A)	89,6/89,0	90,4/89,9	91,1/90,9	91,5/91,3	91,3	92,0/91,9	92,4/92,3	92,8	93,3/93,1	93,1	94,3/94,2	95,2/95,1	95,4/95,3
Sound pressure [STD] <sup>5)</sup>	dB(A)	57,5/56,9	58,3/57,8	59,0/58,8	59,4/59,2	59,2	59,9/59,8	60,3/60,2	60,7	61,1/60,9	60,9	62,1/62,0	63,0/62,9	63,2/63,1
Sound power [S]	dB(A)	-/85,0	-/85,4	-/87,2	-/87,4	87,4	-/87,6	-/87,8	88,5	-/88,6	88,6	-/89,7	-/90,1	-/90,3
Sound pressure [S] <sup>5)</sup>	dB(A)	-/52,9	-/53,3	-/55,1	-/55,3	55,3	-/55,5	-/55,7	56,4	-/56,4	56,4	-/57,5	-/57,9	-/58,1

Physical features

<b>ECOi-W AQUA-Z DC 150-380 C/H - chiller / heat pump</b>		150	170	190	210	220	230	260	270	290	300	320	350	380
Dimension	Height (STD AC) / (EC/HPF)	2240 / 2312	2240 / 2312	2250 / 2300	2250 / 2300	- / 2300	2250 / 2300	2250 / 2300	- / 2300	2250 / 2300	- / 2300	2250 / 2300	2250 / 2300	2250 / 2300
	Width	1152	1152	2211	2211	2211	2211	2211	2211	2211	2211	2211	2211	2211
	Length	3795	3795	2676	2676	2676	2676	2676	3801	3801	3801	3801	3801	3801

1) According EN 14511-2018: chilled water inlet/outlet temperature: 12/7 °C, outdoor ambient temperature 35 °C DB. 2) According EN 14825 and Following COMMISSION REGULATION (EU) 2016/2281. 3) According EN 14511-2018: warm water inlet/outlet temperature: 40/45 °C, outdoor ambient temperature 7 °C DB/6 °C WB. 4) According EN 14825 and Following COMMISSION REGULATION (EU) No 813/2013. 5) Sound levels are at fully loaded conditions. Sound power values refers to ISO 3744 standard.

Accessories and options	
Anti-vibration rubber mount *	
Desuperheater for sizes 190-380	
Energy meter for power input	
Fin&Tube Al/Cu with Epoxy / Blygold treatment	
High efficiency EC fan	
High pressure fan (HPF)	

Accessories and options	
Mechanical gauges kit (HP and LP manometers)	
Coil guards for sizes 150-170	
Chiller grilles and drain pan for sizes 190-380	
Power factor corrector capacitors	
Shut off valves *	
Soft starter	

Accessories and options	
Super low noise (S) version	
Compressor jackets	
Compressor box for sizes 190-380	
Variable speed pumps	
Water pressure switch	
Water tank	

\* Field-installed accessories. All other accessories are factory-installed.

Accessories supplied loose	
<b>P-586595</b>	Cascade controller
<b>P-372061</b>	Remote keyboard panel
<b>P-372615</b>	Kit 4G modem
<b>SVC-HYD-COMM-CLD1</b>	1-year pre-paid Cloud access
<b>SVC-HYD-COMM-CLD3</b>	3-year pre-paid Cloud access
<b>P-477042</b>	AVS - anti-vibration spring for sizes 150-170
<b>P-477044</b>	AVS - anti-vibration Spring for sizes 190-260 C version
<b>P-477045</b>	AVS - anti-vibration Spring for sizes 190-260 H version

Accessories supplied loose	
<b>P-477047</b>	AVS - anti-vibration Spring for sizes 270-380
<b>P-477043</b>	AVS - anti-vibration Spring with tank for sizes 150-170
<b>P-477046</b>	AVS - anti-vibration Spring with tank for sizes 190-260
<b>P-477048</b>	AVS - anti-vibration Spring with tank for sizes 290-380 C version
<b>P-477049</b>	AVS - anti-vibration Spring with tank for sizes 270-380 H version
<b>P-348619</b>	WF - water filter

--	--	--	--	--	--	--	--	--	--



# ECOi-W AQV C/H/E - R410A

Air cooled chillers, heat pumps and condensing units.

Cooling capacity: 83,3 to 136,6 kW.

Heating capacity: 91,8 to 146,9 kW.



## Operating limits

To be confirmed with AC SELECT:  
<https://acselect.panasonic.eu/>

Ambient temperature (chiller and heat pump).

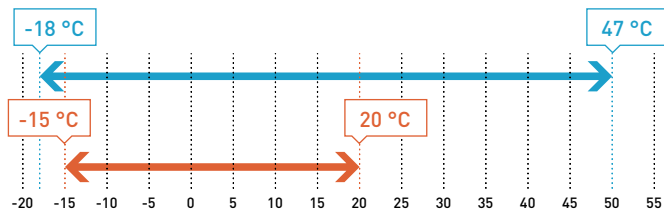

Leaving water temperature (chiller and heat pump).

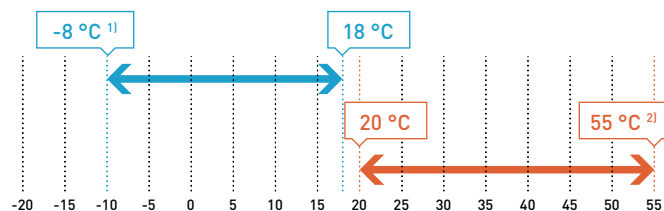

1) With glycol, 5 °C without glycol.

2) Leaving water temperature maximum 55 °C (external air temperature minimum 6 °C) to be confirmed with AC SELECT selection software.

### ECOi-W AQV 85-140 C/H - chiller / heat pump

Cooling	Outdoor air temperature	S	°C	From -18 to 44
		HT	°C	From -18 to 50 (85-115) From -18 to 47 (125-140)
Heating	Outdoor air temperature	S	°C	From -4 to 20
		Polar Version	°C	From -15 to 20
External static pressure		STD / HPF	Pa	0 / <120

### ECOi-W AQV 85-140 E - condensing unit

Evaporating limit			°C	From 1 to 15
		STD	°C	From 0 to 48
Outdoor air temperature	S		°C	From -18 to 45
	HT		°C	From 0 to 50

## The range at a glance

- 3 versions: C (chiller), H (heat pump) and E (condensing unit)
- 6 sizes
- 3 configurations: STD (standard), HT (high temperature) and HPF (high pressure fan)
- 2 fan types: AC (standard fan) and EC (HSE model: high seasonal efficiency)
- 2 acoustic options: STD (standard) and S (super low noise)

## Advantages

- High seasonal performances: SEER up to 4,9
- Common configuration for the different versions: easy upgrade of the units in stock or on field
- Electronic expansion device: excellent control of superheating for the best performance at full and partial load and for a safe operation
- Microchannel coils: significant reduction on refrigerant charge and operating weight (C type)
- Compressor box: remarkable sound reduction even for the basic noise version
- Control platform: modular architecture, compressor envelope integration, corrective actions in border line areas, easy-friendly user interface

## Equipment

- 2 refrigerant circuits
- 4 scroll compressors (tandem)
- Plate evaporator (AISI 316)
- Microprocessor control
- Low operating water content in the plant
- Electronic expansion valve as standard
- Brine version for process application
- Polar version for extreme conditions
- E-coating coil treatment as standard
- Compressor acoustic box
- Compressor jackets (standard on S)
- Phase sequence control
- Water flow switch



## Technical performance

	Voltage	V	400	400	400	400	400	400
Power supply	Phase		Three phase	Three phase	Three phase	Three phase	Three phase	Three phase
	Frequency		Hz	50	50	50	50	50
Size			<b>85</b>	<b>95</b>	<b>105</b>	<b>115</b>	<b>125</b>	<b>140</b>
<b>ECOi-W AQV 85-140 C - chiller</b>			<b>P-AQVE0085CA</b>	<b>P-AQVE0095CA</b>	<b>P-AQVE0105CA</b>	<b>P-AQVE0115CA</b>	<b>P-AQVE0125CA</b>	<b>P-AQVE0140CA</b>
Cooling capacity <sup>1)</sup>	kW		83,5	93,6	103,0	110,1	121,9	136,6
Input power <sup>1)</sup>	kW		26,9	31,0	33,5	36,5	41,1	46,1
EER <sup>1)</sup>			3,10	3,03	3,06	3,03	2,98	2,97
EER HSE <sup>1)</sup>			3,19	3,10	3,13	3,09	3,05	3,04
<b>SEER <sup>2)3)</sup></b>			<b>4,55</b>	<b>4,8</b>	<b>4,78</b>	<b>4,8</b>	<b>4,73</b>	<b>4,53</b>
<b>η<sub>s,c</sub> <sup>2)3)</sup></b>			<b>179</b>	<b>189</b>	<b>188</b>	<b>189</b>	<b>186</b>	<b>178</b>
<b>SEER HSE <sup>2)3)</sup></b>			<b>4,73</b>	<b>4,75</b>	<b>4,95</b>	<b>4,95</b>	<b>4,78</b>	<b>4,6</b>
<b>η<sub>s,c</sub> HSE <sup>2)3)</sup></b>			<b>186</b>	<b>187</b>	<b>195</b>	<b>195</b>	<b>188</b>	<b>181</b>
Nominal water flow (in the evaporator)	m <sup>3</sup> /h		14,3	16,1	17,6	19,0	21,0	23,5
Sound power <sup>4)</sup>	dB(A)		84	84	84	84	88	88
Sound pressure at 10 m <sup>5)</sup>	dB(A)		52	52	52	52	56	56
Sound power HPF <sup>4)</sup>	dB(A)		92	92	92	92	95	95
Sound pressure at 10 m HPF <sup>5)</sup>	dB(A)		60	60	60	60	63	63
<b>ECOi-W AQV 85-140 C S - chiller</b>			<b>85</b>	<b>95</b>	<b>105</b>	<b>115</b>	<b>125</b>	<b>140</b>
Cooling capacity <sup>1)</sup>	kW		80,6	90,2	98,6	106	119,1	133,1
Input power <sup>1)</sup>	kW		28	32,6	35,5	38,6	41,1	46,5
EER <sup>1)</sup>			2,87	2,76	2,77	2,73	2,90	2,86
EER HSE <sup>1)</sup>			3,00	2,87	2,87	2,81	2,96	2,91
<b>SEER <sup>2)3)</sup></b>			<b>4,75</b>	<b>4,78</b>	<b>4,98</b>	<b>5,0</b>	<b>4,8</b>	<b>4,6</b>
<b>η<sub>s,c</sub> <sup>2)3)</sup></b>			<b>187</b>	<b>188</b>	<b>196</b>	<b>197</b>	<b>189</b>	<b>181</b>
<b>SEER HSE <sup>2)3)</sup></b>			<b>4,8</b>	<b>4,75</b>	<b>4,88</b>	<b>4,88</b>	<b>4,9</b>	<b>4,7</b>
<b>η<sub>s,c</sub> HSE <sup>2)3)</sup></b>			<b>189</b>	<b>187</b>	<b>192</b>	<b>192</b>	<b>193</b>	<b>185</b>
Nominal water flow (in the evaporator)	m <sup>3</sup> /h		13,9	15,5	16,9	18,2	20,5	22,9
Sound power <sup>4)</sup>	dB(A)		82	82	82	82	86	86
Sound pressure at 10 m <sup>5)</sup>	dB(A)		50	50	50	50	54	54
<b>ECOi-W AQV 85-140 C HT - chiller</b>			<b>85</b>	<b>95</b>	<b>105</b>	<b>115</b>	<b>125</b>	<b>140</b>
Cooling capacity <sup>1)</sup>	kW		86,2	96,9	107	115	124	139
Input power <sup>1)</sup>	kW		28,1	31,6	33,9	36,4	41,1	46
EER <sup>1)</sup>			3,07	3,06	3,15	3,16	3,03	3,03
<b>SEER <sup>2)3)</sup></b>			<b>4,73</b>	<b>4,75</b>	<b>4,95</b>	<b>4,95</b>	<b>4,78</b>	<b>4,6</b>
<b>η<sub>s,c</sub> <sup>2)3)</sup></b>			<b>186</b>	<b>187</b>	<b>195</b>	<b>195</b>	<b>188</b>	<b>181</b>
Nominal water flow (in the evaporator)	m <sup>3</sup> /h		14,8	16,6	18,3	19,8	21,4	24,0
Sound power <sup>4)</sup>	dB(A)		95	95	95	95	95	95
Sound pressure at 10 m <sup>5)</sup>	dB(A)		63	63	63	63	63	63

1) According EN 14511-2013: chilled water inlet/outlet temperature: 12/7 °C, outdoor ambient temperature 35 °C DB. 2) ErP compliant: following COMMISSION REGULATION (EU) 2016/2281. 3) According EN 14825. 4) Sound levels are at fully loaded conditions. Sound power values refers to ISO 3744 standard. 5) Sound pressures refer to ISO 3744 standard, parallelepiped shape.

## Accessories and options

Anti-vibration spring dampers
Automatic circuit breaker
Coils treatments
Desuperheater
Fan speed control
Hydrokit with 1 or 2 pumps with or without buffer tank
Mechanical gauges

## Accessories and options

Overload protection for compressors
Power factor corrector capacitors
Several communication protocols
Soft starter
Unit protection grilles
Water differential pressure

## Accessories supplied loose

<b>P-376463</b>	Sequencer for up to 4 chillers installation
<b>P-347941</b>	Remote ON / OFF
<b>P-364735</b>	Remote keyboard panel
<b>P-348000</b>	Coil guards for sizes 85-115
<b>P-348001</b>	Coil guards for sizes 125-140

## Accessories supplied loose

<b>P-347999</b>	Chiller grilles for sizes 85-115
<b>P-347998</b>	Chiller grilles for sizes 125-140
<b>P-473465</b>	Pressure switch
<b>P-348615</b>	Water filter for sizes 85-105
<b>P-348616</b>	Water filter for sizes 115-140





## Technical performance

Power supply	Voltage	V	400	400	400	400	400	400
	Phase		Three phase	Three phase	Three phase	Three phase	Three phase	Three phase
	Frequency	Hz	50	50	50	50	50	50
Size			85	95	105	115	125	140
<b>ECOi-W AQV 85-140 H - heat pump</b>			<b>P-AQVE0085HA</b>	<b>P-AQVE0095HA</b>	<b>P-AQVE0105HA</b>	<b>P-AQVE0115HA</b>	<b>P-AQVE0125HA</b>	<b>P-AQVE0140HA</b>
Cooling capacity <sup>1)</sup>	kW		81	89,9	98,9	106,9	115,8	129,2
Input power <sup>1)</sup>	kW		27,5	31,5	34,2	36,9	41,8	46,5
EER <sup>1)</sup>			2,95	2,85	2,89	2,89	2,77	2,78
EER HSE <sup>1)</sup>			3,05	2,94	2,97	2,96	2,84	2,84
<b>SEER <sup>2)</sup></b>			<b>4,25</b>	<b>4,68</b>	<b>4,63</b>	<b>4,17</b>	<b>4,33</b>	<b>4,28</b>
$\eta_{s,c}$ <sup>2)</sup>			<b>167</b>	<b>184</b>	<b>182</b>	<b>164</b>	<b>170</b>	<b>168</b>
<b>SEER HSE <sup>2)</sup></b>			<b>4,6</b>	<b>5,03</b>	<b>4,95</b>	<b>4,55</b>	<b>4,6</b>	<b>4,5</b>
$\eta_{s,c}$ HSE <sup>2)</sup>			<b>181</b>	<b>198</b>	<b>195</b>	<b>179</b>	<b>181</b>	<b>177</b>
Nominal water flow (in the evaporator)	m <sup>3</sup> /h		13,9	15,5	17,0	18,4	19,9	22,2
Heating capacity <sup>3)</sup>	kW		91,8	102,8	110	119	134	146,9
Input power <sup>3)</sup>	kW		26,8	30,5	32,2	35,2	40,9	44,8
COP <sup>3)</sup>			3,42	3,37	3,42	3,38	3,28	3,28
COP HSE <sup>3)</sup>			3,54	3,47	3,52	3,47	3,36	3,36
COP <sup>4)</sup>			4,35	4,28	4,36	4,32	4,16	4,17
COP HSE <sup>4)</sup>			4,53	4,44	4,52	4,46	4,29	4,28
<b>SCOP <sup>2) 5)</sup></b>			<b>3,61</b>	<b>3,64</b>	<b>3,78</b>	<b>3,77</b>	<b>3,47</b>	<b>3,54</b>
$\eta_{s,h}$ <sup>2) 5)</sup>			<b>141</b>	<b>143</b>	<b>148</b>	<b>148</b>	<b>136</b>	<b>139</b>
Nominal water flow (in the evaporator)	m <sup>3</sup> /h		17,2	17,8	19,3	20,6	23,3	25,5
Sound power <sup>6)</sup>	dB(A)		84	84	84	84	88	88
Sound pressure at 10 m <sup>7)</sup>	dB(A)		52	52	52	52	56	56
Sound power HPF <sup>6)</sup>	dB(A)		92	92	92	92	95	95
Sound pressure at 10 m HPF <sup>7)</sup>	dB(A)		60	60	60	60	63	63
<b>ECOi-W AQV 85-140 H S - heat pump</b>			<b>85</b>	<b>95</b>	<b>105</b>	<b>115</b>	<b>125</b>	<b>140</b>
Cooling capacity <sup>1)</sup>	kW		78,4	86,7	95,1	102	112	124,6
Input power <sup>1)</sup>	kW		28,6	33,2	36,0	39,1	43,1	47,6
EER <sup>1)</sup>			2,75	2,61	2,64	2,62	2,61	2,63
EER HSE <sup>1)</sup>			2,84	2,69	2,71	2,69	2,65	2,67
<b>SEER <sup>2)</sup></b>			<b>4,25</b>	<b>4,68</b>	<b>4,63</b>	<b>4,17</b>	<b>4,33</b>	<b>4,28</b>
$\eta_{s,c}$ <sup>2)</sup>			<b>167</b>	<b>184</b>	<b>182</b>	<b>164</b>	<b>170</b>	<b>168</b>
<b>SEER HSE <sup>2)</sup></b>			<b>4,6</b>	<b>5,03</b>	<b>4,95</b>	<b>4,55</b>	<b>4,6</b>	<b>4,5</b>
$\eta_{s,c}$ HSE <sup>2)</sup>			<b>181</b>	<b>198</b>	<b>195</b>	<b>179</b>	<b>181</b>	<b>177</b>
Nominal water flow (in the evaporator)	m <sup>3</sup> /h		13,5	14,9	16,3	17,6	19,3	21,5
Heating capacity <sup>3)</sup>	kW		89,5	99,8	108	115	129	142
Input power <sup>3)</sup>	kW		26,4	30,1	32,0	34,7	39,3	43,0
COP <sup>3)</sup>			3,39	3,32	3,36	3,32	3,29	3,30
COP HSE <sup>3)</sup>			3,55	3,46	3,50	3,45	3,38	3,38
COP <sup>4)</sup>			4,32	4,24	4,31	4,25	4,22	4,24
COP HSE <sup>4)</sup>			4,58	4,46	4,51	4,44	4,34	4,35
<b>SCOP <sup>2) 5)</sup></b>			<b>3,61</b>	<b>3,64</b>	<b>3,78</b>	<b>3,77</b>	<b>3,47</b>	<b>3,54</b>
$\eta_{s,h}$ <sup>2) 5)</sup>			<b>141</b>	<b>143</b>	<b>148</b>	<b>148</b>	<b>136</b>	<b>139</b>
Nominal water flow (in the evaporator)	m <sup>3</sup> /h		15,6	17,4	18,8	20,1	22,5	24,7
Sound power <sup>6)</sup>	dB(A)		82	82	82	82	86	86
Sound pressure at 10 m <sup>7)</sup>	dB(A)		50	50	50	50	54	54
<b>ECOi-W AQV 85-140 H HT - heat pump</b>			<b>85</b>	<b>95</b>	<b>105</b>	<b>115</b>	<b>125</b>	<b>140</b>
Cooling capacity <sup>1)</sup>	kW		83,5	93,4	104	112	118	132
Input power <sup>1)</sup>	kW		28,4	32,0	34,4	37	42	46,2
EER <sup>1)</sup>			2,94	2,9	3,02	3,02	2,8	2,85
<b>SEER <sup>2)</sup></b>			<b>4,6</b>	<b>5,02</b>	<b>4,95</b>	<b>4,55</b>	<b>4,6</b>	<b>4,5</b>
$\eta_{s,c}$ <sup>2)</sup>			<b>181</b>	<b>198</b>	<b>195</b>	<b>179</b>	<b>181</b>	<b>177</b>
Nominal water flow (in the evaporator)	m <sup>3</sup> /h		14,3	16,0	17,8	19,2	20,3	22,7
Heating capacity <sup>3)</sup>	kW		93,4	104,9	113,7	121,9	135	148
Input power <sup>3)</sup>	kW		29,4	33,1	35,0	37,8	42,2	46,1
COP <sup>3)</sup>			3,18	3,17	3,25	3,23	3,21	3,21
COP <sup>4)</sup>			3,98	3,98	4,08	4,07	4,06	4,08
<b>SCOP <sup>2) 5)</sup></b>			<b>3,99</b>	<b>3,96</b>	<b>4,12</b>	<b>4,07</b>	<b>3,73</b>	<b>3,77</b>
$\eta_{s,h}$ <sup>2) 5)</sup>			<b>157</b>	<b>155</b>	<b>162</b>	<b>160</b>	<b>146</b>	<b>148</b>
Nominal water flow (in the evaporator)	m <sup>3</sup> /h		16,3	18,3	19,8	21,2	23,6	25,8
Sound power <sup>6)</sup>	dB(A)		95	95	95	95	95	95
Sound pressure at 10 m <sup>7)</sup>	dB(A)		63	63	63	63	63	63

1) According EN 14511-2013: chilled water inlet/outlet temperature: 12/7 °C, outdoor ambient temperature 35 °C DB. 2) According EN 14825. 3) According EN 14511-2013: warm water inlet/outlet temperature: 40/45 °C, outdoor ambient temperature 7 °C DB/6 °C WB. 4) According EN 14511-2013: warm water inlet/outlet temperature: 30/35 °C, outdoor ambient temperature 7 °C DB/6 °C WB. 5) ErP compliant: following COMMISSION REGULATION (EU) No 813/2013. 6) Sound levels are at fully loaded conditions. Sound power values refers to ISO 3744 standard. 7) Sound pressures refer to ISO 3744 standard, parallelepiped shape.



## Technical performance

	Voltage	V	400	400	400	400	400	400
Power supply	Phase		Three phase	Three phase	Three phase	Three phase	Three phase	Three phase
	Frequency	Hz	50	50	50	50	50	50
<b>Size</b>			<b>85</b>	<b>95</b>	<b>105</b>	<b>115</b>	<b>125</b>	<b>140</b>
<b>ECOi-W AQV 85-140 E STD / HSE / HPF - condensing unit</b>			<b>P-AQVE0085EA</b>	<b>P-AQVE0095EA</b>	<b>P-AQVE0105EA</b>	<b>P-AQVE0115EA</b>	<b>P-AQVE0125EA</b>	<b>P-AQVE0140EA</b>
Cooling capacity <sup>1)</sup>	kW		92,1	103,2	113,2	121,8	134,7	151,0
Input power <sup>1)</sup>	kW		27,4	31,4	34,1	37,0	41,7	46,8
Sound power <sup>2)</sup>	dB(A)		84	84	84	84	88	88
Sound pressure at 10 m <sup>3)</sup>	dB(A)		53	53	53	53	57	57
<b>ECOi-W AQV 85-140 E STD / HSE S - condensing unit</b>			<b>85</b>	<b>95</b>	<b>105</b>	<b>115</b>	<b>125</b>	<b>140</b>
Cooling capacity <sup>1)</sup>	kW		89	99,5	108,7	116,6	131,6	147,2
Input power <sup>1)</sup>	kW		28,6	33,1	36,1	39,3	41,9	47,3
Sound power <sup>2)</sup>	dB(A)		82	82	82	82	86	86
Sound pressure at 10 m <sup>3)</sup>	dB(A)		51	51	51	51	55	55
<b>ECOi-W AQV 85-140 E HT - condensing unit</b>			<b>85</b>	<b>95</b>	<b>105</b>	<b>115</b>	<b>125</b>	<b>140</b>
Cooling capacity <sup>1)</sup>	kW		95	106,8	117,7	127	137,2	153,8
Input power <sup>1)</sup>	kW		28,5	32,1	34,4	36,9	41,8	46,7
Sound power <sup>2)</sup>	dB(A)		95	95	95	95	95	95
Sound pressure at 10 m <sup>3)</sup>	dB(A)		64	64	64	64	64	64

## Physical features

<b>ECOi-W AQV 85-140 C/H/E - chiller / heat pump / condensing unit</b>			<b>85</b>	<b>95</b>	<b>105</b>	<b>115</b>	<b>125</b>	<b>140</b>
Dimension	HxWxL	mm	2185 x 1095 x 2555	2185 x 1095 x 2555	2185 x 1095 x 2555	2185 x 1095 x 2555	2185 x 1095 x 3155	2185 x 1095 x 3155
Operating weight (C type)	STD / HT / S	kg	1058 / 1058 / 1088	1072 / 1072 / 1102	1111 / 1111 / 1141	1143 / 1143 / 1173	1183 / 1183 / 1213	1262 / 1262 / 1292
Operating weight (H type)	STD / HT / S	kg	1090 / 1090 / 1120	1105 / 1105 / 1135	1149 / 1149 / 1179	1180 / 1180 / 1210	1227 / 1227 / 1257	1301 / 1301 / 1331
Shipping weight (E type)	STD / S	kg	971 / 1001	983 / 1013	1013 / 1043	1043 / 1073	1066 / 1096	1142 / 1172
<b>Water connections (85-140 C/H types)</b>								
Type of water connections (evaporator)			Male gas threaded	Male gas threaded	Male gas threaded	Male gas threaded	Male gas threaded	Male gas threaded
Water inlet/outlet diameter		Inch	2 ½	2 ½	2 ½	2 ½	2 ½	2 ½
<b>Condenser (85-140 E type)</b>								
Connection type			To be brazed	To be brazed	To be brazed	To be brazed	To be brazed	To be brazed
Inlet diameter	Inch		5/8	5/8	5/8	5/8	7/8	7/8
Outlet diameter	Inch		1 3/8	1 3/8	1 3/8	1 3/8	1 3/8	1 3/8

1) Data refers to 7 °C leaving chilled water temperature and 35 °C condenser air temperature, according EN 14511-2013 standard. 2) Sound levels are at fully loaded conditions. Sound power values refers to ISO 3744 standard. 3) Sound pressures refer to ISO 3744 standard, parallelepiped shape.





# ECOi-W VL H/E · R410A

Air cooled heat pumps and condensing units.

Cooling capacity: 176,2 to 307 kW.

Heating capacity: 200 to 337,4 kW.



## Operating limits

To be confirmed with AC SELECT:

<https://acselect.panasonic.eu/>

ECOi-W VL 604-904 H - heat pump		704	804	904	
Cooling	Water outlet temperature	Water	°C	From 6 to 15	
		Water with glycol	°C	From 0 to 15	
		Water with glycol (Brine version)	°C	From -8 to 15	
	ΔT	K	From 3 to 8		
	Outdoor air temperature	STD	°C	-5 to 47	0 to 46
L		°C	-5 to 45	0 to 44	0 to 45
S		°C	-18 to 41	-18 to 40	-18 to 41
HT		°C	-18 to 49	-18 to 48	-18 to 49
ECOi-W VL 1004-1204 H - heat pump		1004	1104	1204	
Cooling	Water outlet temperature	Water	°C	From 6 to 15	
		Water with glycol	°C	From 0 to 15	
		Water with glycol (Brine version)	°C	From -8 to 15	
	ΔT	K	From 3 to 8		
	Outdoor air temperature	STD	°C	0 to 46	0 to 45
L		°C	0 to 44	0 to 42	0 to 42
S		°C	-18 to 40	-18 to 38	-18 to 38
HT		°C	-18 to 48	-18 to 47	-18 to 47
ECOi-W VL 604-1204 H - heat pump					
Heating	Water outlet temperature	°C	From 30 to 50 <sup>1)</sup>		
	Outdoor air temperature	°C	From -10 to 20 <sup>1)</sup>		
External static pressure	STD fans	Pa	0		
	Inverter HPF	Pa	<120		
ECOi-W VL 604-904 E - condensing unit		704	804	904	
Outdoor air temperature	Evaporating temperature	°C	From 1 to 15		
	STD	°C	-18 to 47 <sup>1)</sup>	-18 to 46 <sup>1)</sup>	-18 to 46 <sup>2)</sup>
	L / S	°C	-18 to 45 <sup>1)</sup>	-18 to 44 <sup>1)</sup>	-18 to 45 <sup>2)</sup>
	HT	°C	-18 to 49 <sup>1)</sup>	-18 to 48 <sup>1)</sup>	-18 to 49 <sup>2)</sup>
ECOi-W VL 604-904 E - condensing unit		1004	1104	1204	
Outdoor air temperature	Evaporating temperature	°C	1 to 15		
	STD	°C	-18 to 46 <sup>2)</sup>	-18 to 45 <sup>2)</sup>	-18 to 45 <sup>2)</sup>
	L / S	°C	-18 to 44 <sup>2)</sup>	-18 to 42 <sup>2)</sup>	-18 to 42 <sup>2)</sup>
	HT	°C	-18 to 48 <sup>2)</sup>	-18 to 47 <sup>2)</sup>	-18 to 47 <sup>2)</sup>

1) Maximum water outlet temperature 50 °C (minimum temperature outdoor air +0 °C) to be confirmed with AC SELECT selection software. 2) At high pressure 40,5 bar. Chillers suitable for operation without buffer tank for water content greater than 3 liters of water per kW of output.

## The range at a glance

- 2 versions: H (heat pump) and E (condensing unit)
- 6 sizes
- 3 configurations: STD (standard), HT (high temperature) and HPF (high pressure fan)
- 2 fan types: AC (standard fan) and EC (HSE model: high seasonal efficiency)
- 3 acoustic options: STD (standard), L (low noise) and S (super low noise)

## Advantages

- High seasonal performances: SCOP up to 3,4
- Small footprint
- Common configuration for the different versions: easy upgrade of the units in stock or on field
- Electronic expansion device: excellent control of superheating for the best performance at full and partial load and for a safe operation
- Compressor box: remarkable sound reduction even for the basic noise version
- Control platform: modular architecture, compressor envelope integration, corrective actions in border line areas, easy-friendly user interface

## Equipment

- 2 refrigerant circuits
- 4 scroll compressors (tandem)
- Plate evaporator (AISI 316)
- Microprocessor control
- Electronic expansion valve
- E-coating coil treatment
- Compressor acoustic box
- Phase sequence control
- Water differential pressure switch

## Accessories and options

Anti-vibration spring dampers
Automatic circuit breaker
Coils treatments
Compressor jackets (standard on S)
Desuperheater
Fan speed control (-18 °C)
Hydrokit with 1 or 2 pumps with or without buffer tank (500 L) (+1 m of length)
Inverter fans
Mechanical gauges
Overload protection for compressors
Power factor corrector capacitors
Several communication protocols
Soft starter
Unit protection grilles





Technical performance

Power supply	Voltage	V	400	400	400	400	400	400
	Phase		Three phase	Three phase	Three phase	Three phase	Three phase	Three phase
	Frequency	Hz	50	50	50	50	50	50
Size			704	804	904	1004	1104	1204
<b>ECOi-W VL 704-1204 H STD / HPF - heat pump</b>			<b>P-VLE0704HA</b>	<b>P-VLE0804HA</b>	<b>P-VLE0904HA</b>	<b>P-VLE1004HA</b>	<b>P-VLE1104HA</b>	<b>P-VLE1204HA</b>
Cooling capacity <sup>1)</sup>	kW		173,2	197,1	226,4	246,3	273,1	299,9
Input power <sup>1)</sup>	kW		65,9	72,2	82,4	86,8	99,8	114,0
EER <sup>1)</sup>			2,62	2,73	2,74	2,84	2,74	2,63
<b>SEER <sup>2)</sup></b>			<b>3,63</b>	<b>3,55</b>	<b>3,35</b>	<b>3,5</b>	<b>3,53</b>	<b>3,43</b>
$\eta_{s,c}$ <sup>2)</sup>			<b>142</b>	<b>139</b>	<b>131</b>	<b>137</b>	<b>138</b>	<b>134</b>
<b>SEER HSE <sup>2)</sup></b>			<b>3,95</b>	<b>3,83</b>	<b>3,65</b>	<b>3,8</b>	<b>3,78</b>	<b>3,68</b>
$\eta_{s,c}$ HSE <sup>2)</sup>			<b>155</b>	<b>150</b>	<b>143</b>	<b>149</b>	<b>148</b>	<b>144</b>
Nominal water flow (in the evaporator)	m <sup>3</sup> /h		29,9	33,9	38,8	42,4	47,0	51,6
Heating capacity <sup>3)</sup>	kW		200,1	223,2	254,7	270,8	302,1	337,4
Input power <sup>3)</sup>	kW		67,4	70,4	79,6	87,6	100,0	112,5
COP <sup>3)</sup>			2,97	3,17	3,20	3,09	3,02	3,00
COP <sup>4)</sup>			3,71	3,96	3,99	3,86	3,78	3,77
<b>SCOP <sup>2) 5)</sup></b>			<b>3,41</b>	<b>3,42</b>	<b>3,28</b>	<b>3,39</b>	<b>3,30</b>	<b>3,19</b>
$\eta_{s,h}$ <sup>2) 5)</sup>			<b>133</b>	<b>134</b>	<b>128</b>	<b>133</b>	<b>129</b>	<b>125</b>
<b>SCOP HSE <sup>2) 5)</sup></b>			<b>3,44</b>	<b>3,4</b>	<b>3,32</b>	<b>3,33</b>	<b>3,37</b>	<b>3,3</b>
Nominal water flow (in the evaporator)	m <sup>3</sup> /h		34,7	38,6	43,6	47,0	52,3	58,4
Sound power <sup>6)</sup>	dB(A)		93	93	94	94	95	95
Sound pressure at 10 m <sup>7)</sup>	dB(A)		61	61	62	62	63	63
<b>ECOi-W VL 704-1204 H L - heat pump</b>			<b>704</b>	<b>804</b>	<b>904</b>	<b>1004</b>	<b>1104</b>	<b>1204</b>
Cooling capacity <sup>1)</sup>	kW		168,2	191,2	220,4	237,3	261,2	285,1
Input power <sup>1)</sup>	kW		66,2	73,3	83,8	88,5	102,8	119,8
EER <sup>1)</sup>			2,54	2,61	2,63	2,68	2,54	2,38
<b>SEER <sup>2)</sup></b>			<b>3</b>	<b>3</b>	<b>3,1</b>	<b>3,28</b>	<b>3,3</b>	<b>3,23</b>
$\eta_{s,c}$ <sup>2)</sup>			<b>117</b>	<b>117</b>	<b>121</b>	<b>128</b>	<b>129</b>	<b>126</b>
<b>SEER HSE <sup>2)</sup></b>			<b>3,95</b>	<b>3,83</b>	<b>3,65</b>	<b>3,80</b>	<b>3,78</b>	<b>3,68</b>
$\eta_{s,c}$ HSE <sup>2)</sup>			<b>155</b>	<b>150</b>	<b>143</b>	<b>149</b>	<b>148</b>	<b>144</b>
Nominal water flow (in the evaporator)	m <sup>3</sup> /h		29,0	32,9	38,2	40,8	45,0	49,1
Heating capacity <sup>3)</sup>	kW		195,0	217,1	247,7	261,8	288,9	322,2
Input power <sup>3)</sup>	kW		65,2	68,3	76,9	84,7	97,0	109,2
COP <sup>3)</sup>			2,99	3,18	3,22	3,09	2,98	2,95
COP <sup>4)</sup>			3,77	4,01	4,06	3,9	3,76	3,72
<b>SCOP <sup>2) 5)</sup></b>			<b>3,41</b>	<b>3,42</b>	<b>3,28</b>	<b>3,39</b>	<b>3,20</b>	<b>3,19</b>
$\eta_{s,h}$ <sup>2) 5)</sup>			<b>133</b>	<b>134</b>	<b>128</b>	<b>133</b>	<b>125</b>	<b>125</b>
<b>SCOP HSE <sup>2) 5)</sup></b>			<b>3,44</b>	<b>3,4</b>	<b>3,32</b>	<b>3,33</b>	<b>3,37</b>	<b>3,24</b>
Nominal water flow (in the evaporator)	m <sup>3</sup> /h		33,8	37,5	42,5	45,4	50,0	55,8
Sound power <sup>6)</sup>	dB(A)		87	87	88	88	89	89
Sound pressure at 10 m <sup>7)</sup>	dB(A)		55	55	56	56	57	57
<b>ECOi-W VL 704-1204 H S - heat pump</b>			<b>704</b>	<b>804</b>	<b>904</b>	<b>1004</b>	<b>1104</b>	<b>1204</b>
Cooling capacity <sup>1)</sup>	kW		164,3	185,2	214,5	230,4	253,3	276,1
Input power <sup>1)</sup>	kW		69,0	76,2	86,1	90,7	106,9	124,9
EER <sup>1)</sup>			2,38	2,43	2,49	2,54	2,37	2,21
<b>SEER <sup>2)</sup></b>			<b>3,63</b>	<b>3,55</b>	<b>3,35</b>	<b>3,5</b>	<b>3,53</b>	<b>3,43</b>
$\eta_{s,c}$ <sup>2)</sup>			<b>142</b>	<b>139</b>	<b>131</b>	<b>137</b>	<b>138</b>	<b>134</b>
<b>SEER HSE <sup>2)</sup></b>			<b>3,95</b>	<b>3,83</b>	<b>3,65</b>	<b>3,8</b>	<b>3,78</b>	<b>3,68</b>
$\eta_{s,c}$ HSE <sup>2)</sup>			<b>155</b>	<b>150</b>	<b>143</b>	<b>149</b>	<b>148</b>	<b>144</b>
Nominal water flow (in the evaporator)	m <sup>3</sup> /h		28,3	31,9	36,9	39,7	43,6	47,5
Heating capacity <sup>3)</sup>	kW		184,9	202,9	232,6	245,7	266,8	297,0
Input power <sup>3)</sup>	kW		64,9	67,0	75,8	83,9	95,0	108,0
COP <sup>3)</sup>			2,85	3,03	3,07	2,93	2,81	2,75
COP HSE <sup>3)</sup>			2,95	3,13	3,19	3,04	2,90	2,83
COP <sup>4)</sup>			3,6	3,83	3,88	3,71	3,56	3,48
COP HSE <sup>4)</sup>			3,76	3,98	4,07	3,87	3,7	3,59
<b>SCOP <sup>2) 5)</sup></b>			<b>3,41</b>	<b>3,42</b>	<b>3,28</b>	<b>3,39</b>	<b>3,30</b>	<b>3,19</b>
$\eta_{s,h}$ <sup>2) 5)</sup>			<b>133</b>	<b>134</b>	<b>128</b>	<b>133</b>	<b>129</b>	<b>125</b>
<b>SCOP HSE <sup>2) 5)</sup></b>			<b>3,44</b>	<b>3,4</b>	<b>3,32</b>	<b>3,33</b>	<b>3,37</b>	<b>3,26</b>
Nominal water flow (in the evaporator)	m <sup>3</sup> /h		32,0	35,2	40,4	42,5	46,3	51,5
Sound power <sup>6)</sup>	dB(A)		83	83	84	84	85	85
Sound pressure at 10 m <sup>7)</sup>	dB(A)		51	51	52	52	53	53

1) According EN 14511-2013: chilled water inlet/outlet temperature: 12/7 °C, outdoor ambient temperature 35 °C DB. 2) According EN 14825. 3) According EN 14511-2013: warm water inlet/outlet temperature: 40/45 °C, outdoor ambient temperature 7 °C DB/6 °C WB. 4) According EN 14511-2013: warm water inlet/outlet temperature: 30/35 °C, outdoor ambient temperature 7 °C DB/6 °C WB. 5) ErP compliant: following COMMISSION REGULATION (EU) No 813/2013. 6) Sound levels are at fully loaded conditions. Sound power values refers to ISO 3744 standard. 7) Sound pressures refer to ISO 3744 standard, parallelepiped shape.

Accessories supplied loose

<b>P-376463</b>	Sequencer for up to 4 chillers installation
<b>P-347941</b>	Remote ON / OFF
<b>P-364735</b>	Remote keyboard panel
<b>P-348003</b>	Chiller grilles

Accessories supplied loose

<b>P-365581</b>	Flow switch
<b>P-473465</b>	Pressure switch
<b>P-348619</b>	Water filter

--	--	--	--	--	--	--





## Technical performance

Power supply	Voltage	V	400	400	400	400	400	400
	Phase		Three phase	Three phase	Three phase	Three phase	Three phase	Three phase
	Frequency	Hz	50	50	50	50	50	50
<b>ECOi-W VL 704-1204 H HT - heat pump</b>			<b>704</b>	<b>804</b>	<b>904</b>	<b>1004</b>	<b>1104</b>	<b>1204</b>
Cooling capacity <sup>1)</sup>	kW	175,6	199,7	229,5	250,1	276,5	305,6	
Input power <sup>1)</sup>	kW	66,3	72,4	83,6	87,4	101,1	114,2	
EER <sup>1)</sup>		2,64	2,75	2,74	2,85	2,73	2,67	
<b>SEER <sup>2)</sup></b>		<b>3</b>	<b>3</b>	<b>3,1</b>	<b>3,28</b>	<b>3,3</b>	<b>3,23</b>	
$\eta_{sc}$ <sup>2)</sup>		<b>117</b>	<b>117</b>	<b>121</b>	<b>128</b>	<b>129</b>	<b>126</b>	
Nominal water flow (in the evaporator)	m <sup>3</sup> /h	30,1	34,3	39,4	42,9	47,5	52,5	
Heating capacity <sup>3)</sup>	kW	200,7	224,0	256,6	273,7	305,5	341,5	
Input power <sup>3)</sup>	kW	68,6	71,7	81,8	90,2	103	115	
COP <sup>3)</sup>		2,93	3,13	3,14	3,04	2,98	2,97	
COP <sup>4)</sup>		3,66	3,92	3,91	3,79	3,73	3,73	
<b>SCOP <sup>2) 5)</sup></b>		<b>3,44</b>	<b>3,40</b>	<b>3,32</b>	<b>3,33</b>	<b>3,37</b>	<b>3,26</b>	
$\eta_{s,h}$ <sup>2) 5)</sup>		<b>135</b>	<b>133</b>	<b>130</b>	<b>130</b>	<b>132</b>	<b>127</b>	
Nominal water flow (in the evaporator)	m <sup>3</sup> /h	34,9	39,0	44,7	47,6	53,2	59,4	
Sound power <sup>6)</sup>	dB(A)	99	99	100	100	100	100	
Sound pressure at 10 m <sup>7)</sup>	dB(A)	67	67	68	68	68	68	
<b>Size</b>		<b>704</b>	<b>804</b>	<b>904</b>	<b>1004</b>	<b>1104</b>	<b>1204</b>	
<b>ECOi-W VL 704-1204 E STD / HPF - condensing unit</b>			<b>P-VLE0704EA</b>	<b>P-VLE0804EA</b>	<b>P-VLE0904EA</b>	<b>P-VLE1004EA</b>	<b>P-VLE1104EA</b>	<b>P-VLE1204EA</b>
Cooling capacity <sup>8)</sup>	kW	199,0	224,0	258,0	283,0	315,0	347,0	
Input power <sup>8)</sup>	kW	68,7	74,7	86,6	90,6	106	120	
Sound power <sup>6)</sup>	dB(A)	93	93	94	94	95	95	
Sound pressure at 10 m <sup>7)</sup>	dB(A)	61	61	62	62	63	63	
<b>ECOi-W VL 704-1204 E L - condensing unit</b>			<b>704</b>	<b>804</b>	<b>904</b>	<b>1004</b>	<b>1104</b>	<b>1204</b>
Cooling capacity <sup>8)</sup>	kW	194,0	218,0	251,0	272,5	301,0	330,0	
Input power <sup>8)</sup>	kW	69,6	76,6	87,8	92,8	109	126	
Sound power <sup>6)</sup>	dB(A)	87	87	88	88	89	89	
Sound pressure at 10 m <sup>7)</sup>	dB(A)	55	55	56	56	57	57	
<b>ECOi-W VL 704-1204 E S - condensing unit</b>			<b>704</b>	<b>804</b>	<b>904</b>	<b>1004</b>	<b>1104</b>	<b>1204</b>
Cooling capacity <sup>8)</sup>	kW	188,5	211,0	244,0	264,5	292,0	319,0	
Input power <sup>8)</sup>	kW	72,0	79,5	90,5	95,5	112	131	
Sound power <sup>6)</sup>	dB(A)	83	83	84	84	85	85	
Sound pressure at 10 m <sup>7)</sup>	dB(A)	51	51	52	52	53	53	
<b>ECOi-W VL 704-1204 E HT - condensing unit</b>			<b>704</b>	<b>804</b>	<b>904</b>	<b>1004</b>	<b>1104</b>	<b>1204</b>
Cooling capacity <sup>8)</sup>	kW	201,0	226,5	261,0	286,5	318,0	353,0	
Input power <sup>8)</sup>	kW	68,9	74,9	87,1	91,0	105	119	
Sound power <sup>6)</sup>	dB(A)	99	99	100	100	100	100	
Sound pressure at 10 m <sup>7)</sup>	dB(A)	67	67	68	68	68	68	

1) According EN 14511-2013: chilled water inlet/outlet temperature: 12/7 °C, outdoor ambient temperature 35 °C DB. 2) According EN 14825. 3) According EN 14511-2013: warm water inlet/outlet temperature: 40/45 °C, outdoor ambient temperature 7 °C DB/6 °C WB. 4) According EN 14511-2013: warm water inlet/outlet temperature: 30/35 °C, outdoor ambient temperature 7 °C DB/6 °C WB. 5) ErP compliant: following COMMISSION REGULATION (EU) No 813/2013. 6) Sound levels are at fully loaded conditions. Sound power values refers to ISO 3744 standard. 7) Sound pressures refer to ISO 3744 standard, parallelepiped shape. 8) Data refers to 7 °C leaving chilled water temperature and 35 °C condenser air temperature.

**Physical features**

<b>ECOi-W VL 704 - 1204 H/E - heat pump / condensing unit</b>			<b>704</b>	<b>804</b>	<b>904</b>	<b>1004</b>	<b>1104</b>	<b>1204</b>
Dimension	HxWxL	mm	2300 x 1100 x 4300	2300 x 1100 x 4300	2300 x 1100 x 4300	2300 x 1100 x 4300	2300 x 1100 x 4300	2300 x 1100 x 4300
Operating weight - heat pump	STD / L	kg	1675	1820	1980	2125	2215	2225
	S	kg	1710	1855	2015	2165	2255	2265
	HT	kg	1705	1850	2020	2165	2255	2265
Shipping weight - condensing unit	STD / L	kg	1490	1615	1700	1825	1910	1920
	S	kg	1525	1650	1735	1865	1950	1960
	HT	kg	1520	1645	1740	1865	1950	1960
<b>ECOi-W VL 704-1204 H STD / HPF - heat pump</b>			<b>704</b>	<b>804</b>	<b>904</b>	<b>1004</b>	<b>1104</b>	<b>1204</b>
<b>Water connections</b>								
Type of water connections (evaporator)			Male gas threaded	Male gas threaded	Male gas threaded	Male gas threaded	Male gas threaded	Male gas threaded
Water inlet/outlet diameter		Inch	2 1/2	2 1/2	3	3	3	3
<b>ECOi-W VL 704-1204 E - condensing unit</b>			<b>704</b>	<b>804</b>	<b>904</b>	<b>1004</b>	<b>1104</b>	<b>1204</b>
<b>Refrigerant connections</b>								
Inlet diameter		Inch	7/8	7/8	1 1/8	1 1/8	1 1/8	1 1/8
Outlet diameter		Inch	1 5/8	1 5/8	2 1/8	2 1/8	2 1/8	2 1/8



# ECOi-W AQUA EVO 230-360 C/H/E · R410A

Air cooled chillers, heat pumps and condensing units.

**Cooling capacity: 231 to 360,7 kW.**

**Heating capacity: 229 to 361,4 kW.**



## Operating limits

To be confirmed with AC SELECT:

<https://acselect.panasonic.eu/>

ECOi-W AQUA EVO 230-360 C - chiller				
Chilled liquid	Liquid outlet temperature	Water	°C	From 5 to 18
		Water with glycol*	°C	From -10 to 5
		Temperature spread	K	From 3 to 7
Maximum operating pressure		bar	6	
Outdoor air temperature	Air entering temperature cooling	STD	°C	From 5 to 48
		L	°C	From 0 to 46
		S	°C	From -14 to 44
		EC-HT	°C	From -18 to 50
External static pressure	STD fans	Pa	0	
	High pressure fan (HPF)	Pa	<120	
ECOi-W AQUA EVO 230-360 H - heat pump				
Chilled liquid	Liquid outlet temperature	Water	°C	From 5 to 18
		Water with glycol*	°C	From -10 to 5
		ΔT	K	From 3 to 7
Outdoor air temperature	Air entering temperature cooling	STD / L / S	°C	5 to 48 / 0 to 46 / -14 to 44
		EC-HT	°C	From -18 to 50
Warm liquid	Liquid outlet temperature	Water	°C	From 20 to 55
		ΔT	K	From 3 to 7
Outdoor air temperature	Air entering temperature heating	STD / L / S / EC	°C	From -10 to 20
		Polar Version	°C	From -13 to 20
		HT	°C	From -13 to 20
External static pressure	STD fans	Pa	0	
	High pressure fan (HPF)	Pa	<120	
ECOi-W AQUA EVO 230-360 E - condensing unit				
Evaporating temperature		°C	From 1 to 15	
Outdoor air temperature		STD	°C	From 5 to 48
		L	°C	From -14 to 46
		S	°C	From -14 to 44
		EC-HT	°C	From -18 to 50

\* For Liquid outlet temperature <0 °C provide Brine Version (available for C; upon request for H).

## The range at a glance

- 3 versions: C (chiller), H (heat pump) and E (condensing unit)
- 6 sizes
- 3 configurations: STD (standard), HT (high temperature) and HPF (high pressure fan)
- 2 fan types: AC (standard fan) and EC (high efficiency fan)
- 3 acoustic options: STD (standard), L (low noise) and S (super low noise)

## Advantages

- High seasonal performances: SEER up to 4,3
- Common configuration for the different versions: easy upgrade of the units in stock or on field
- Electronic expansion device: excellent control of superheating for the best performance at full and partial load and for a safe operation
- Microchannel coils: significant reduction on refrigerant charge and operating weight
- Compressor box: remarkable sound reduction even for the basic noise version
- Control platform: modular architecture, compressor envelope integration, corrective actions in border line areas, easy-friendly user interface

## Equipment

- 2 refrigerant circuits
- 4 scroll compressors (tandem)
- Electronic expansion valve
- Microchannel coils (C type)
- E-coating coil treatment
- Brine version: chiller for process application LWT -10 °C (C type)
- Polar version: heat pump for extreme conditions (H type)
- Plate heat exchanger evaporator
- Compressor acoustic box
- Compressor jackets (standard as super low noise)
- Fan speed control (standard as super low noise)
- Phase sequence control
- Water differential pressure switch



## Technical performance

	Voltage	V	400	400	400	400	400	400
Power supply <sup>1)</sup>	Phase		Three phase	Three phase	Three phase	Three phase	Three phase	Three phase
	Frequency	Hz	50	50	50	50	50	50
<b>Size</b>			<b>230</b>	<b>260</b>	<b>280</b>	<b>300</b>	<b>330</b>	<b>360</b>
<b>ECOi-W AQUA EVO 230-360 C - chiller</b>			<b>P-AQAVE0230CA</b>	<b>P-AQAVE0260CA</b>	<b>P-AQAVE0280CA</b>	<b>P-AQAVE0300CA</b>	<b>P-AQAVE0330CA</b>	<b>P-AQAVE0360CA</b>
Nominal cooling capacity <sup>2)</sup>	kW		231	263	284	310	331	362
Input power <sup>2)</sup>	kW		74,8	84,6	91,3	99,0	104,7	116,8
EER <sup>2)</sup> / EER*			3,1 / 3,1	3,1 / 3,2	3,1 / 3,2	3,1 / 3,2	3,2 / 3,2	3,1 / 3,2
<b>SEER <sup>3) 4)</sup></b>			<b>4,25</b>	<b>4,25</b>	<b>4,23</b>	<b>4,18</b>	<b>4,20</b>	<b>4,10</b>
<b>n<sub>s,c</sub> <sup>3) 4)</sup></b>			<b>167</b>	<b>167</b>	<b>166</b>	<b>164</b>	<b>165</b>	<b>161</b>
Nominal water flow (in the evaporator)	m <sup>3</sup> /h		39,6	45,2	48,8	53,2	56,9	62,1
Sound power <sup>5)</sup>	dB(A)		92	93	93	94	95	95
Sound pressure 10 m <sup>6)</sup>	dB(A)		60	61	61	62	63	63
<b>ECOi-W AQUA EVO 230-360 C L - chiller</b>			<b>230</b>	<b>260</b>	<b>280</b>	<b>300</b>	<b>330</b>	<b>360</b>
Nominal cooling capacity <sup>2)</sup>	kW		224	256	276	301	322	351
Input power <sup>2)</sup>	kW		74,4	84,5	92,0	99,7	104,9	117,8
EER <sup>2)</sup> / EER*			3 / 3,02	3,0 / 3,1	3,0 / 3,0	3,0 / 3,1	3,1 / 3,1	3 / 3,03
<b>SEER <sup>3) 4)</sup></b>			<b>4,28</b>	<b>4,28</b>	<b>4,25</b>	<b>4,25</b>	<b>4,25</b>	<b>4,10</b>
<b>n<sub>s,c</sub> <sup>3) 4)</sup></b>			<b>168</b>	<b>168</b>	<b>167</b>	<b>167</b>	<b>167</b>	<b>161</b>
Nominal water flow (in the evaporator)	m <sup>3</sup> /h		38,4	43,9	47,4	51,7	55,3	60,2
Sound power <sup>5)</sup>	dB(A)		87	88	88	89	90	90
Sound pressure 10 m <sup>6)</sup>	dB(A)		55	56	56	57	58	58
<b>ECOi-W AQUA EVO 230-360 C S - chiller</b>			<b>230</b>	<b>260</b>	<b>280</b>	<b>300</b>	<b>330</b>	<b>360</b>
Nominal cooling capacity <sup>2)</sup>	kW		210	242	259	283	305	329
Input power <sup>2)</sup>	kW		79,2	88,6	97,4	105,6	109,7	123,7
EER <sup>2)</sup> / EER*			2,7 / 2,7	2,7 / 2,8	2,7 / 2,7	2,7 / 2,7	2,8 / 2,8	2,7 / 2,7
<b>SEER <sup>3) 4)</sup></b>			<b>4,1</b>	<b>4,15</b>	<b>4,1</b>	<b>4,1</b>	<b>4,1</b>	<b>4,1</b>
<b>n<sub>s,c</sub> <sup>3) 4)</sup></b>			<b>161</b>	<b>163</b>	<b>161</b>	<b>161</b>	<b>161</b>	<b>161</b>
Nominal water flow (in the evaporator)	m <sup>3</sup> /h		36,1	41,5	44,6	48,6	52,4	56,6
Sound power <sup>5)</sup>	dB(A)		82	83	83	85	86	86
Sound pressure 10 m <sup>6)</sup>	dB(A)		50	51	51	53	54	54
<b>ECOi-W AQUA EVO 230-360 C HT - chiller</b>			<b>230</b>	<b>260</b>	<b>280</b>	<b>300</b>	<b>330</b>	<b>360</b>
Nominal cooling capacity <sup>2)</sup>	kW		232	265	286	312	333	364
Input power <sup>2)</sup>	kW		77,6	87,9	94,7	103,7	109,9	121,7
EER <sup>2)</sup>			2,99	3,01	3,02	3,01	3,03	2,99
<b>SEER <sup>3) 4)</sup></b>			<b>4,63</b>	<b>4,65</b>	<b>4,63</b>	<b>4,68</b>	<b>4,65</b>	<b>4,43</b>
<b>n<sub>s,c</sub> <sup>3) 4)</sup></b>			<b>182</b>	<b>183</b>	<b>182</b>	<b>184</b>	<b>183</b>	<b>174</b>
Nominal water flow (in the evaporator)	m <sup>3</sup> /h		40,0	45,6	49,3	53,7	57,3	62,7
Sound power <sup>5)</sup>	dB(A)		94	96	96	97	98	98
Sound pressure 10 m <sup>6)</sup>	dB(A)		62	64	64	65	66	66

1) Voltage 400 V +/- 10%. 2) According EN 14511-2013: chilled water inlet/outlet temperature: 12/7 °C, outdoor ambient temperature 35 °C DB. 3) ErP compliant: following COMMISSION REGULATION (EU) 2016/2281. 4) According EN 14825. 5) Sound levels are at fully loaded conditions. Sound power values refers to ISO 3744 standard. 6) Sound pressures refer to ISO 3744 standard, parallelepiped shape.

### Accessories and options

Anti-vibration spring dampers
Automatic circuit breaker
Coils treatments
Desuperheater
Fan speed control [-14 °C in cooling mode – standard as super low noise version]
Hydrokit with 1 or 2 pumps with or without buffer tank (500 L)
Mechanical gauges

### Accessories and options

Overload protection for compressors
Power factor corrector capacitors
Several communication protocols
Soft starter
Unit protection grilles
Variable pump

### Accessories supplied loose

<b>P-376463</b> Sequencer for up to 4 chillers installation
<b>P-347941</b> Remote ON / OFF control
<b>P-364735</b> Remote keyboard panel
<b>P-365581</b> Flow switch

### Accessories supplied loose

<b>P-473465</b> Pressure switch
<b>P-348619</b> Water filter
<b>P-348619</b> Water filter





## Technical performance

Power supply <sup>1)</sup>	Voltage	V	400	400	400	400	400	400
	Phase		Three phase	Three phase	Three phase	Three phase	Three phase	Three phase
	Frequency	Hz	50	50	50	50	50	50
Size			<b>230</b>	<b>260</b>	<b>280</b>	<b>300</b>	<b>330</b>	<b>360</b>
ECOi-W AQUA EVO 230-360 H - heat pump			P-AQAVE0230HA	P-AQAVE0260HA	P-AQAVE0280HA	P-AQAVE0300HA	P-AQAVE0330HA	P-AQAVE0360HA
Nominal cooling capacity <sup>2)</sup>	kW		214	244	261	288	307	341
Input power <sup>2)</sup>	kW		73,2	83,8	90,7	98,5	103,5	117,0
EER <sup>2)</sup>			2,92	2,91	2,88	2,92	2,97	2,91
EER* / EER**			2,96 / 2,75	2,95 / 2,73	2,91 / 2,71	2,96 / 2,75	3,02 / 2,78	2,95 / 2,74
SEER / $\eta_{s,c}$ <sup>3)</sup>			<b>4,13 / 162</b>	<b>4,05 / 159</b>	<b>4,1 / 161</b>	<b>3,83 / 150</b>	<b>3,8 / 149</b>	<b>3,93 / 154</b>
SEER* / SEER** <sup>3)</sup>			<b>4,22</b>	<b>4,13</b>	<b>4,2</b>	<b>3,93</b>	<b>3,8</b>	<b>4,05</b>
$\eta_{s,c}$ * / $\eta_{s,c}$ ** <sup>3)</sup>			<b>166</b>	<b>162</b>	<b>165</b>	<b>154</b>	<b>149</b>	<b>159</b>
Nominal water flow (in the evaporator)	m <sup>3</sup> /h		36,8	42,0	45,0	49,5	52,9	58,6
Nominal heating capacity <sup>4) 5)</sup>	40-45 °C / 30-35 °C	kW	229 / 234	262 / 269	280 / 286	306 / 311	327 / 334	361 / 368
Input power <sup>4) 5)</sup>	40-45 °C / 30-35 °C	kW	70,9 / 58,7	81,7 / 67,8	87,4 / 72,3	94,9 / 77,8	101,9 / 83,7	112,6 / 92,7
COP <sup>4) 5)</sup>	40-45 °C / 30-35 °C		3,23 / 3,98	3,21 / 3,96	3,20 / 3,95	3,22 / 4,00	3,21 / 3,99	3,21 / 3,97
COP* / COP**			3,27 / 3,03	3,26 / 3,01	3,25 / 3,02	3,27 / 3,02	3,26 / 2,99	3,26 / 3,02
SCOP <sup>3) 4)</sup>			<b>3,46</b>	<b>3,48</b>	<b>3,44</b>	<b>3,51</b>	<b>3,44</b>	<b>3,48</b>
$\eta_{s,h}$ <sup>3) 4)</sup>			<b>135</b>	<b>136</b>	<b>135</b>	<b>137</b>	<b>135</b>	<b>136</b>
Nominal water flow (in the evaporator)	m <sup>3</sup> /h		39,7	45,5	48,5	53,0	56,8	62,7
Sound power <sup>7)</sup>	dB(A)		92	93	93	94	95	95
Sound pressure at 10 m <sup>8)</sup>	dB(A)		60	61	61	62	63	63
ECOi-W AQUA EVO 230-360 H L - heat pump			<b>230</b>	<b>260</b>	<b>280</b>	<b>300</b>	<b>330</b>	<b>360</b>
Nominal cooling capacity <sup>2)</sup>	kW		207	237	253	279	299	330
Input power <sup>2)</sup>	kW		73,7	83,7	91,4	99,1	103,1	117,5
EER <sup>2)</sup> / EER*			2,81 / 2,85	2,83 / 2,87	2,77 / 2,81	2,82 / 2,86	2,90 / 2,94	2,81 / 2,84
SEER / $\eta_{s,c}$ <sup>3)</sup>			<b>4,13 / 162</b>	<b>4,05 / 159</b>	<b>4,1 / 161</b>	<b>3,83 / 150</b>	<b>3,8 / 149</b>	<b>3,93 / 154</b>
SEER* / SEER** <sup>3)</sup>			<b>3,7 / 145</b>	<b>3,65 / 143</b>	<b>3,63 / 142</b>	<b>2,58 / 100</b>	<b>2,65 / 103</b>	<b>4,17 / 164</b>
Nominal water flow (in the evaporator)	m <sup>3</sup> /h		35,7	40,8	43,6	48,1	51,5	56,8
Nominal heating capacity <sup>4) 5)</sup>	40-45 °C / 30-35 °C	kW	224 / 228	256 / 261	272 / 277	299 / 304	321 / 326	354 / 359
Input power <sup>4) 5)</sup>	40-45 °C / 30-35 °C	kW	69,0 / 56,5	79,4 / 65,2	84,8 / 69,8	92,7 / 75,2	99,6 / 81,0	109,9 / 89,8
COP <sup>4) 5)</sup>	40-45 °C / 30-35 °C		3,24 / 4,03	3,22 / 4,00	3,21 / 3,97	3,23 / 4,04	3,22 / 4,03	3,22 / 4,00
COP* <sup>4)</sup>			3,32	3,31	3,29	3,31	3,31	3,30
SCOP <sup>3) 4)</sup>			<b>3,46</b>	<b>3,48</b>	<b>3,44</b>	<b>3,51</b>	<b>3,44</b>	<b>3,48</b>
$\eta_{s,h}$ <sup>3) 4)</sup>			<b>135</b>	<b>136</b>	<b>135</b>	<b>137</b>	<b>135</b>	<b>136</b>
Nominal water flow (in the evaporator)	m <sup>3</sup> /h		38,8	44,3	47,2	52,0	55,7	61,4
Sound power <sup>7)</sup>	dB(A)		87	88	88	89	90	90
Sound pressure at 10 m <sup>8)</sup>	dB(A)		55	56	56	57	58	58
ECOi-W AQUA EVO 230-360 H S - heat pump			<b>230</b>	<b>260</b>	<b>280</b>	<b>300</b>	<b>330</b>	<b>360</b>
Nominal cooling capacity <sup>2)</sup>	kW		194	224	239	263	284	311
Input power <sup>2)</sup>	kW		77,6	88,2	96,6	104,5	108,2	124,2
EER <sup>2)</sup> / EER*			2,51 / 2,54	2,54 / 2,58	2,47 / 2,50	2,52 / 2,55	2,62 / 2,66	2,50 / 2,53
SEER / $\eta_{s,c}$ <sup>3)</sup>			<b>4,13 / 162</b>	<b>4,05 / 159</b>	<b>3,60 / 141</b>	<b>3,83 / 150</b>	<b>3,8 / 149</b>	<b>3,93 / 154</b>
SEER* / SEER** <sup>3)</sup>			<b>3,7 / 145</b>	<b>3,65 / 143</b>	<b>3,63 / 142</b>	<b>2,58 / 100</b>	<b>2,65 / 103</b>	<b>4,17 / 164</b>
Nominal water flow (in the evaporator)	m <sup>3</sup> /h		33,5	38,6	41,1	45,3	48,8	53,5
Nominal heating capacity <sup>4) 5)</sup>	40-45 °C / 30-35 °C	kW	220 / 223	251 / 255	267 / 271	295 / 298	315 / 320	349 / 353
Input power <sup>4) 5)</sup>	40-45 °C / 30-35 °C	kW	67,2 / 55,1	77,2 / 63,5	82,4 / 67,8	90,4 / 73,5	96,9 / 78,9	107,4 / 87,6
COP <sup>4) 5)</sup>	40-45 °C / 30-35 °C		3,27 / 4,05	3,25 / 4,02	3,24 / 4,00	3,26 / 4,06	3,25 / 4,05	3,25 / 4,03
SCOP <sup>3) 4)</sup>			<b>3,46</b>	<b>3,48</b>	<b>3,44</b>	<b>3,51</b>	<b>3,44</b>	<b>3,48</b>
$\eta_{s,h}$ <sup>3) 4)</sup>			<b>135</b>	<b>136</b>	<b>135</b>	<b>137</b>	<b>135</b>	<b>136</b>
Nominal water flow (in the evaporator)	m <sup>3</sup> /h		38,1	43,5	46,3	51,2	54,7	60,5
Sound power <sup>7)</sup>	dB(A)		82	83	83	85	86	86
Sound pressure at 10 m <sup>8)</sup>	dB(A)		50	51	51	53	54	54
ECOi-W AQUA EVO 230-360 H HT - heat pump			<b>230</b>	<b>260</b>	<b>280</b>	<b>300</b>	<b>330</b>	<b>360</b>
Nominal cooling capacity <sup>2)</sup>	kW		216	246	263	290	310	343
Input power <sup>2)</sup>	kW		77,0	88,4	95,1	103,7	109,9	123,1
EER <sup>2)</sup>			2,80	2,78	2,77	2,80	2,82	2,79
SEER / $\eta_{s,c}$ <sup>3)</sup>			<b>3,8 / 149</b>	<b>3,73 / 146</b>	<b>3,78 / 148</b>	<b>4,28 / 168</b>	<b>3,95 / 155</b>	<b>4,08 / 160</b>
Nominal water flow (in the evaporator)	m <sup>3</sup> /h		37,1	42,3	45,4	50,0	53,3	59,1
Nominal heating capacity <sup>4)</sup>	kW		232	266	284	310	332	367
Input power <sup>4)</sup>	kW		75,7	87,2	92,7	101,2	109,0	119,8
COP <sup>4)</sup>			3,07 / 3,76	3,05 / 3,73	3,06 / 3,73	3,06 / 3,76	3,04 / 3,73	3,06 / 3,74
SCOP <sup>3) 4)</sup>			<b>3,56</b>	<b>3,57</b>	<b>3,53</b>	<b>3,61</b>	<b>3,55</b>	<b>3,58</b>
$\eta_{s,h}$ <sup>3) 4)</sup>			<b>139</b>	<b>140</b>	<b>138</b>	<b>141</b>	<b>139</b>	<b>140</b>
Nominal water flow (in the evaporator)	m <sup>3</sup> /h		40,3	46,1	49,2	53,8	57,5	63,6
Sound power <sup>7)</sup>	dB(A)		94	96	96	97	98	98
Sound pressure at 10 m <sup>8)</sup>	dB(A)		62	64	64	65	66	66

1) Voltage 400 V +/- 10%. 2) According EN 14511-2013: chilled water inlet/outlet temperature: 12/7 °C, outdoor ambient temperature 35 °C DB. 3) According EN 14825. 4) According EN 14511-2013: warm water inlet/outlet temperature: 40/45 °C, outdoor ambient temperature 7 °C DB/6 °C WB. 5) According EN 14511-2013: warm water inlet/outlet temperature: 30/35 °C, outdoor ambient temperature 7 °C DB/6 °C WB. 6) ErP compliant: following COMMISSION REGULATION (EU) No 813/2013. 7) Sound levels are at fully loaded conditions. Sound power values refers to ISO 3744 standard. 8) Sound pressures refer to ISO 3744 standard, parallelepiped shape.

\* High efficiency units (EC) with Inverter fans. \*\* H type units with high static pressure fans.



## Technical performance

Power supply	Voltage	V	400	400	400	400	400	400
	Phase		Three phase	Three phase	Three phase	Three phase	Three phase	Three phase
	Frequency	Hz	50	50	50	50	50	50
Size			<b>230</b>	<b>260</b>	<b>280</b>	<b>300</b>	<b>330</b>	<b>360</b>
<b>ECOi-W AQUA EVO 230-360 E - condensing unit</b>			<b>P-AQAVE0230EA</b>	<b>P-AQAVE0260EA</b>	<b>P-AQAVE0280EA</b>	<b>P-AQAVE0300EA</b>	<b>P-AQAVE0330EA</b>	<b>P-AQAVE0360EA</b>
Nominal cooling capacity <sup>1)</sup>	kW	250	288	313	337	361	395	
Input power <sup>1)</sup>	kW	74,6	84,4	91,6	99,4	105	117	
Sound power <sup>2)</sup>	dB(A)	92	93	93	94	95	95	
Sound pressure at 10 m <sup>3)</sup>	dB(A)	60	61	61	62	63	63	
<b>ECOi-W AQUA EVO 230-360 E L - condensing unit</b>			<b>230</b>	<b>260</b>	<b>280</b>	<b>300</b>	<b>330</b>	<b>360</b>
Nominal cooling capacity <sup>1)</sup>	kW	242	279	302	326	351	381	
Input power <sup>1)</sup>	kW	75,4	84,8	92,6	100	105	118	
Sound power <sup>2)</sup>	dB(A)	87	88	88	89	90	90	
Sound pressure at 10 m <sup>3)</sup>	dB(A)	55	56	56	57	58	58	
<b>ECOi-W AQUA EVO 230-360 E S - condensing unit</b>			<b>230</b>	<b>260</b>	<b>280</b>	<b>300</b>	<b>330</b>	<b>360</b>
Nominal cooling capacity <sup>1)</sup>	kW	225	262	281	305	330	356	
Input power <sup>1)</sup>	kW	80,1	89,6	98,4	107	111	126	
Sound power <sup>2)</sup>	dB(A)	82	83	83	85	86	86	
Sound pressure at 10 m <sup>3)</sup>	dB(A)	50	51	51	53	54	54	
<b>ECOi-W AQUA EVO 230-360 E HT - condensing unit</b>			<b>230</b>	<b>260</b>	<b>280</b>	<b>300</b>	<b>330</b>	<b>360</b>
Nominal cooling capacity <sup>1)</sup>	kW	253	291	316	341	364	398	
Input power <sup>1)</sup>	kW	78,2	88,9	95,8	105	111	123	
Sound power <sup>2)</sup>	dB(A)	94	96	96	97	98	98	
Sound pressure at 10 m <sup>3)</sup>	dB(A)	62	64	64	65	66	66	

## Physical features

<b>ECOi-W AQUA EVO 230-360 C/H - chiller / heat pump</b>			<b>230</b>	<b>260</b>	<b>280</b>	<b>300</b>	<b>330</b>	<b>360</b>
Dimension	HxWxL	mm	2500 x 2150 x 3500	2500 x 2150 x 3500	2500 x 2150 x 3500	2500 x 2150 x 4550	2500 x 2150 x 4550	2500 x 2150 x 4550
Operating weight - chiller	STD / L	kg	1693	1890	1953	2227	2345	2519
	S	kg	1698	1895	1958	2232	2350	2524
	HT	kg	1743	1950	2013	2297	2425	2599
Operating weight - heat pump	STD / L	kg	2078	2343	2458	2702	2887	3063
	S	kg	2083	2348	2463	2707	2892	3068
	HT	kg	2128	2403	2518	2772	2967	3143
<b>Water connections</b>								
Type of water connections (evaporator)			Male gas threaded	Male gas threaded	Male gas threaded	Male gas threaded	Male gas threaded	Male gas threaded
Water inlet/outlet diameter	Inch		3	3	3	3	3	3
<b>ECOi-W AQUA EVO 230-360 E - condensing unit</b>			<b>230</b>	<b>260</b>	<b>280</b>	<b>300</b>	<b>330</b>	<b>360</b>
Dimension	HxWxL	mm	2500 x 2150 x 3500	2500 x 2150 x 3500	2500 x 2150 x 3500	2500 x 2150 x 4550	2500 x 2150 x 4550	2500 x 2150 x 4550
Shipping weight	kg		1542	1726	1788	1946	2061	2235
<b>Refrigerant connections</b>								
Connection type			To be brazed	To be brazed	To be brazed	To be brazed	To be brazed	To be brazed
Inlet diameter	Inch		1 5/8 - 2 1/8	1 5/8 - 2 1/8	1 5/8 - 2 1/8	2 1/8	2 1/8	2 1/8
Outlet diameter	Inch		7/8 - 1 1/8	7/8 - 1 1/8	7/8 - 1 1/8	1 1/8	1 1/8	1 1/8

1) Data refers to 7 °C leaving chilled water temperature and 35 °C condenser air temperature. 2) Sound levels are at fully loaded conditions. Sound power values refers to ISO 3744 standard. 3) Sound pressures refer to ISO 3744 standard, parallelepiped shape.



# ECOi-W AQUA EVO 400-800 C/H - R410A

Air cooled chillers and heat pumps.

Cooling capacity: 390,4 to 775,4 kW.

Heating capacity: 404 to 805,3 kW.



## Operating limits

To be confirmed with AC SELECT:  
<https://acselect.panasonic.eu/>

ECOi-W AQUA EVO 400-800 C - chiller				
Chilled liquid	Liquid outlet temperature	Water	°C	From 5 to 18
		Water with glycol*	°C	From -10 to 5
		ΔT	K	From 3 to 7
	Maximum operating pressure	bar	6	
Outdoor air temperature	Air entering temperature cooling	STD	°C	From 10 to 48
		S / EC / EC S	°C	From -18 to 48
		HT	°C	From -18 to 52
External static pressure	STD fans	Pa	0	
	High pressure fan (HPF)	Pa	<120	
ECOi-W AQUA EVO 400-800 H - heat pump				
Chilled liquid	Liquid outlet temperature	Water	°C	From 5 to 18
		Water with glycol	°C	From -3 to 5
		ΔT	K	From 3 to 7
Outdoor air temperature	Air entering temperature cooling	STD	°C	From 10 to 46
		S / EC / EC S	°C	From -18 to 46
Warm liquid	Liquid outlet temperature	Water	°C	From 25 to 55
		ΔT	K	From 3 to 7
Outdoor air temperature	Air entering temperature heating	STD	°C	From -10 to 20
		S / EC / EC S	°C	From -10 to 35
External static pressure	STD fans	Pa	0	
	High pressure fan (HPF)	Pa	<120	

\* For liquid outlet temperature <-3 °C provide Brine version.

## The range at a glance

- 2 versions: C (chiller) and H (heat pump)
- 8 sizes (C type) / 9 sizes (H type)
- 3 configurations: STD (standard), HT (high temperature) and HPF (high pressure fan)
- 2 fan types: AC (standard fan) and EC (high efficiency fan)
- 2 acoustic options: STD (standard) and S (super low noise)

## Advantages

- High seasonal performances: SEER up to 4,6
- Low sound emission and high efficiency level in a single unit: Super Low Noise version
- Electronic expansion device: excellent control of superheating for the best performance at full and partial load and for a safe operation
- E-coated microchannel coils: Significant reduction on refrigerant charge and operating weight and excellent anticorrosion protection with the standard delivery
- Compressor box: remarkable sound reduction even for the basic noise version
- Control platform: modular architecture, compressor envelope integration, corrective actions in border line areas, easy-friendly user interface

## Equipment

- Brine version: chiller for process application LWT -10 °C
- Polar version: heat pump for extreme conditions
- Plate evaporator
- Electronic expansion valve
- Modbus RS485 (standard for sizes 400-670)
- Microchannel coils (MCHX)
- E-coating coil treatment as standard on MCHX
- Compressor acoustic box
- Compressor jackets (standard as S version)
- Fan speed control (standard as EC/HPF/S versions)
- Phase sequence control
- Water differential pressure switch

## Accessories and options

Anti-vibration spring dampers
Automatic circuit breaker
Coils treatments
Desuperheater
Fan speed control (-14 °C in cooling mode – standard as EC/HPF/S versions)
Hydrokit with 1 or 2 pumps with or without buffer tank (500 L 400-450, 1000 L 470-670)
Mechanical gauges
Overload protection for compressors
Power factor corrector capacitors
Several communication protocols
Soft starter
Unit protection grilles
Variable pump (for sizes 750-800 upon request)





Technical performance

Power supply <sup>1)</sup>	V / Phase / Hz	400/3ph/50	400/3ph/50	400/3ph/50	400/3ph/50	400/3ph/50	400/3ph/50	400/3ph/50	400/3ph/50
<b>Size</b>		<b>400</b>	<b>450 S</b>	<b>490 S</b>	<b>530 S</b>	<b>600</b>	<b>670</b>	<b>750 S</b>	<b>800 S</b>
<b>ECOi-W AQUA EVO 400-800 C AC - chiller</b>	<b>P-AQAVE</b>	<b>0400CA</b>	<b>0450CA</b>	<b>0490CA</b>	<b>0530CA</b>	<b>0600CA</b>	<b>0670CA</b>	<b>0750CA</b>	<b>0800CA</b>
Nominal cooling capacity <sup>2)</sup>	kW	390,4	431,1	470,2	513,7	584,5	653,2	727,7	775,4
Input power <sup>2)</sup>	kW	126,7	138,6	152,7	167,9	189,1	210,7	234,7	250,1
EER <sup>2)</sup>		3,08	3,11	3,08	3,06	3,09	3,10	3,10	3,10
<b>SEER <sup>3)4)</sup> / <math>\eta_{s,c}</math> <sup>3)4)</sup></b>	<b>— / %</b>	<b>4,48 / 176</b>	<b>4,63 / 182</b>	<b>4,58 / 180</b>	<b>4,78 / 188</b>	<b>4,58 / 180</b>	<b>4,59 / 180,7</b>	<b>4,73 / 186</b>	<b>4,70 / 185</b>
Nominal water flow (in the evaporator)	m <sup>3</sup> /h	68,0	75,1	82,0	89,5	101,8	113,9	113,9	135,1
Sound power <sup>5)</sup> / pressure at 10 m <sup>6)</sup>	dB(A)	92 / 60	87 / 54	87 / 54	87 / 54	94 / 61	94 / 61	89 / 56	89 / 56
<b>ECOi-W AQUA EVO 400-800 C EC - chiller</b>		<b>400</b>	<b>450 S</b>	<b>490 S</b>	<b>530 S</b>	<b>600</b>	<b>670</b>	<b>750 S</b>	<b>800 S</b>
Nominal cooling capacity <sup>2)</sup>	kW	400,0	447,0	489,0	535,0	599,0	669,0	751,4	801,4
Input power <sup>2)</sup>	kW	127,0	140,0	154,0	170,0	189,0	211,0	239,7	255,7
EER <sup>2)</sup>		3,15	3,19	3,17	3,16	3,17	3,17	3,13	3,13
<b>SEER <sup>3)4)</sup> / <math>\eta_{s,c}</math> <sup>3)4)</sup></b>	<b>— / %</b>	<b>4,65 / 183</b>	<b>4,58 / 180</b>	<b>4,68 / 184</b>	<b>4,55 / 179</b>	<b>4,78 / 188</b>	<b>4,87 / 192</b>	<b>4,65 / 183</b>	<b>4,68 / 184</b>
Nominal water flow (in the evaporator)	m <sup>3</sup> /h	68,8	76,9	84,2	92,2	103,1	115,1	131,0	139,7
Sound power <sup>5)</sup> / pressure at 10 m <sup>6)</sup>	dB(A)	92 / 60	93 / 61	93 / 60	94 / 61	94 / 61	94 / 61	95 / 62	95 / 62

Power supply <sup>1)</sup>	V / Phase / Hz	400/3ph/50	400/3ph/50	400/3ph/50	400/3ph/50	400/3ph/50	400/3ph/50	400/3ph/50	400/3ph/50	
<b>Size</b>		<b>400</b>	<b>450</b>	<b>490</b>	<b>530</b>	<b>580 S</b>	<b>620 S</b>	<b>670 S</b>	<b>750 S</b>	<b>800 S</b>
<b>ECOi-W AQUA EVO 400-800 H AC - heat pump</b>	<b>P-AQAVE</b>	<b>0400HA</b>	<b>0450HA</b>	<b>0490HA</b>	<b>0530HA</b>	<b>0580HA</b>	<b>0620HA</b>	<b>0670HA</b>	<b>0750HA</b>	<b>0800HA</b>
Nominal cooling capacity <sup>2)</sup>	kW	365,58	410,32	444,87	479,32	520,14	566,34	608,33	686,63	727,45
Input power <sup>2)</sup>	kW	129,64	144,48	157,76	169,37	179,36	194,62	209,77	235,96	250,84
EER <sup>2)</sup>		2,82	2,84	2,82	2,83	2,90	2,91	2,90	2,91	2,90
<b>SEER <sup>4)</sup> / <math>\eta_{s,c}</math> <sup>4)</sup></b>	<b>— / %</b>	<b>4,65 / 183</b>	<b>4,53 / 178</b>	<b>4,70 / 185</b>	<b>4,55 / 179</b>	<b>4,60 / 181</b>	<b>4,60 / 181</b>	<b>4,55 / 179</b>	<b>4,55 / 179</b>	<b>4,58 / 180</b>
Nominal water flow (in the evaporator)	m <sup>3</sup> /h	63,6	71,4	77,4	83,5	90,6	98,7	106,0	119,6	126,8
Nominal heating capacity <sup>7)</sup>	kW	404,0	450,9	492,7	532,1	585,6	627,1	676,7	757,4	805,3
Input power <sup>7)</sup>	kW	125,9	140,9	154,0	166,3	183,0	193,0	209,5	233,8	247,8
COP <sup>7)</sup>		3,21	3,20	3,20	3,20	3,20	3,25	3,23	3,24	3,25
COP <sup>8)</sup>		3,87	3,81	3,84	3,86	3,95	4,01	3,963,85	4,02	3,99
<b>SCOP <sup>4)</sup> / <math>\eta_{s,h}</math> <sup>4)</sup></b>	<b>— / %</b>	<b>3,46 / 135</b>	<b>3,47 / 136</b>	<b>3,37 / 132</b>	<b>3,38 / 132</b>	<b>— / —</b>	<b>— / —</b>	<b>— / —</b>	<b>— / —</b>	<b>— / —</b>
Nominal water flow (in the evaporator)	m <sup>3</sup> /h	70,4	78,6	85,9	92,7	102,0	109,3	118,0	132,1	140,5
Sound power <sup>5)</sup> / pressure at 10 m <sup>6)</sup>	dB(A)	92 / 60	93 / 61	93 / 60	94 / 61	88 / 55	88 / 55	88 / 55	89 / 56	89 / 56
<b>ECOi-W AQUA EVO 400-800 H EC - heat pump</b>		<b>400</b>	<b>450</b>	<b>490</b>	<b>530</b>	<b>580 S</b>	<b>620 S</b>	<b>670 S</b>	<b>750 S</b>	<b>800 S</b>
Nominal cooling capacity <sup>2)</sup>	kW	373,5	419,2	454,5	498,7	533,0	580,0	621,5	704,0	746,0
Input power <sup>2)</sup>	kW	129,0	144,1	156,9	168,6	178,0	194,0	208,2	236,0	251,0
EER <sup>2)</sup>		2,90	2,91	2,90	2,90	2,99	2,99	2,99	2,99	2,97
<b>SEER <sup>4)</sup> / <math>\eta_{s,c}</math> <sup>4)</sup></b>	<b>— / %</b>	<b>4,93 / 194</b>	<b>4,83 / 190</b>	<b>4,97 / 196</b>	<b>4,88 / 192</b>	<b>4,75 / 187</b>	<b>4,73 / 186</b>	<b>4,70 / 185</b>	<b>4,65 / 183</b>	<b>4,65 / 183</b>
Nominal water flow (in the evaporator)	m <sup>3</sup> /h	64,4	72,3	78,4	84,5	92,9	101,1	107,2	122,7	130,1
Nominal heating capacity <sup>7)</sup>	kW	404,0	450,9	492,7	532,1	585,0	626,0	676,7	757,0	805,0
Input power <sup>7)</sup>	kW	122,6	137,1	149,7	161,8	178,0	188,0	203,7	229,0	242,0
COP <sup>7)</sup>		3,30	3,29	3,29	3,29	3,29	3,34	3,32	3,31	3,32
COP <sup>8)</sup>		4,00	3,93	3,97	3,99	4,09	4,15	4,10	4,17	4,14
<b>SCOP <sup>4)</sup> / <math>\eta_{s,h}</math> <sup>4)</sup></b>	<b>— / %</b>	<b>3,62 / 142</b>	<b>3,62 / 142</b>	<b>3,53 / 138</b>	<b>3,53 / 138</b>	<b>— / —</b>	<b>— / —</b>	<b>— / —</b>	<b>— / —</b>	<b>— / —</b>
Nominal water flow (in the evaporator)	m <sup>3</sup> /h	69,3	77,3	84,5	91,2	102,0	109,3	116,0	132,1	140,5
Sound power <sup>5)</sup> / pressure at 10 m <sup>6)</sup>	dB(A)	92 / 60	93 / 61	93 / 60	94 / 61	88 / 55	88 / 55	88 / 55	89 / 56	89 / 56

Physical features

<b>ECOi-W AQUA EVO 400-800 C - chiller</b>			<b>400</b>	<b>450 S</b>	<b>490 S</b>	<b>530 S</b>	<b>600</b>	<b>670</b>	<b>750 S</b>	<b>800 S</b>
Dimension	H x W	mm	2500 x 2175	2500 x 2175	2500 x 2175	2500 x 2175	2500 x 2175	2500 x 2175	2500 x 2175	2500 x 2175
	Length STD / EC / HPF	mm	4580	5620	6680	6680	7760	7760	8900	8900
	Length S / EC S / HT	mm	5620	6680	7760	7760	8800	8800	11000	11000
Operating weight	STD / EC / HPF	kg	3028	3367	3783	4069	4317	4524	5536	5607
	S / EC S / HT	kg	3318	3656	4069	4369	4597	4789	6111	6183

Water connections (evaporator and condenser)

Type of water connections		Victaulic®	Victaulic®	Victaulic®	Victaulic®	Victaulic®	Victaulic®	Victaulic®	Victaulic®	Victaulic®
Water inlet/outlet diameter	Inch	4	4	4	4	4	5	6	6	6

<b>ECOi-W AQUA EVO 400-800 H - heat pump</b>			<b>400</b>	<b>450</b>	<b>490</b>	<b>530</b>	<b>580 S</b>	<b>620 S</b>	<b>670 S</b>	<b>750 S</b>	<b>800 S</b>
Dimension	H x W	mm	2500 x 2175	2500 x 2175	2500 x 2175	2500 x 2175	2500 x 2175	2500 x 2175	2500 x 2175	2500 x 2175	2500 x 2175
	Length STD / EC / HPF	mm	5620	5620	6680	6680	7760	8800	8800	9950	9950
	Length S / EC S	mm	6680	6680	7760	7760	8800	9850	9850	12050	12050
Operating weight	STD / EC / HPF	kg	3769	3938	4412	4744	5214	5554	5691	6790	6985
	S / EC S	kg	4131	4293	4764	5101	5567	5919	6059	7497	7683

Water connections (evaporator)

Type of water connections		Victaulic®	Victaulic®	Victaulic®	Victaulic®	Victaulic®	Victaulic®	Victaulic®	Victaulic®	Victaulic®
Water inlet/outlet diameter	Inch	4	4	4	4	4	5	5	6	6

1) Voltage 400 V +/- 10%. 2) According EN 14511-2013: chilled water inlet/outlet temperature: 12/7 °C, outdoor ambient temperature 35 °C DB. 3) ErP compliant: following COMMISSION REGULATION (EU) 2016/2281. 4) According EN 14825. 5) Sound power is declared in nominal full load condition (cooling operation), referring to ISO standard 9614, in accordance with Eurovent certification program. 6) Sound pressure refer to ISO Standard 3744, parallelepiped shape in a free field on a reflective surface. 7) According EN 14511-2013: warm water inlet/outlet temperature: 40/45 °C, outdoor ambient temperature 7 °C DB/6 °C WB. 8) According EN 14511-2013: warm water inlet/outlet temperature: 30/35 °C, outdoor ambient temperature 7 °C DB/6 °C WB.

Accessories supplied loose

<b>P-376463</b>	Sequencer for up to 4 chillers installation
<b>P-347941</b>	Remote ON / OFF control
<b>P-364735</b>	Remote keyboard panel
<b>P-365581</b>	Flow switch

Accessories supplied loose

<b>P-473465</b>	Pressure switch
<b>P-348620</b>	Water filter for sizes 400-530
<b>P-348618</b>	Water filter for sizes 580-750
<b>P-362589</b>	Water filter for size 800



ErP: Check ErP compliance according to the configurations in AC SLECT: <https://acselect.panasonic.eu/>.





# ECOi-W SW-N EVO 380-1260 C · R513A

Air cooled chillers.

Cooling capacity: 366 to 1240,5 kW.



## Operating limits

To be confirmed with AC SELECT:  
<https://acselect.panasonic.eu/>

ECOi-W SW-N EVO 380-1260 C - chiller			
Leaving water temperature	Water	°C	From 5 to 15
	Water with glycol	°C	From 0 to 5
	Brine	°C	From -8 to 0
	ΔT	K	From 3 to 8
Outdoor air temperature	STD	°C	From -10 to 46
	S	°C	From -10 to 44
	HT	°C	From -10 to 49
	Minimum air temperature	°C	-10
External static pressure	STD fans	Pa	0
	High pressure fans	Pa	< 120

## Accessories and options

Antifreeze electric heater for hydraulic manifolds  
 Anti-vibration spring dampers  
 Chiller grilles  
 Compressor acoustic box  
 Compressor star delta start  
 Compressor suction valve  
 E-coating treatment

## Accessories supplied loose

**P-347941** Remote ON / OFF  
**P-364735** Remote keyboard panel  
**P-365581** Flow switch

## The range at a glance

- 1 version: C (chiller)
- 12 sizes
- 2 configurations: STD (standard) and HT (high temperature)
- 1 fan type: EC (high efficiency fan)
- 2 acoustic options: STD (standard) and S (super low noise)

## Advantages

- High seasonal efficiency level exceeding ErP 2021 requirements
- High durability painting process for casing and frame, offering C4 corrosion category in accordance with ISO 12944
- Compressor metal box, providing basic acoustic protection and resistance to atmospheric agents
- Side panel on coil ends, protecting from corrosion and damage
- EC fan motors, improving part load efficiency, extending envelope operation and reducing noise level in part load operation
- Proprietary software logic, optimizing unit efficiency in accordance with plant needs and protecting unit operation with preventing actions

## Equipment

- 2 refrigerant circuits
- 2 screw compressors
- Pure countercurrent shell and tubes direct expansion heat exchanger
- Axial type EC fan motors
- Micro-channels condensers
- Electronic expansion valve
- Hydronic / heat recovery options

## Accessories and options

Finned tubes [Al/Cu]  
 Hydro kit 1P-SP/1P-HP/2P-SP/2PHP  
 Mechanical gauges kit (HP and LP manometers)  
 Power factor corrector capacitors  
 Several communication protocols  
 Variable pump

## Accessories supplied loose

**P-348620** Water filter for sizes 320-510  
**P-348618** Water filter for sizes 590-730  
**P-362589** Water filter for sizes 810-1260



Technical performance

	Voltage	V	400	400	400	400	400	400	400	400	400	400	400	
Power supply	Phase		Three phase	Three phase	Three phase	Three phase	Three phase	Three phase	Three phase	Three phase	Three phase	Three phase	Three phase	
	Frequency	Hz	50	50	50	50	50	50	50	50	50	50	50	
<b>Size</b>			<b>380</b>	<b>440</b>	<b>510</b>	<b>590</b>	<b>660</b>	<b>730</b>	<b>810</b>	<b>900</b>	<b>980</b>	<b>1060</b>	<b>1160</b>	<b>1260</b>
<b>ECOi-W SW-N EVO 380-1260 C STD / HT / HP - chiller</b>	<b>P-SWVN****CA</b>		<b>0380</b>	<b>0440</b>	<b>0510</b>	<b>0590</b>	<b>0660</b>	<b>0730</b>	<b>0810</b>	<b>0900</b>	<b>0980</b>	<b>1060</b>	<b>1160</b>	<b>1260</b>
Nominal cooling capacity <sup>1)</sup>	kW		365,7	443,0	500,2	565,8	643,5	704,3	778,1	896,9	983,5	1047,4	1154,0	1240,5
Input power <sup>1)</sup>	kW		123,9	142,9	165,6	181,1	206,2	228,6	253,4	290,2	322,3	332,0	370,4	408,1
EER <sup>1)</sup>			2,95	3,10	3,02	3,12	3,12	3,08	3,07	3,09	3,05	3,15	3,12	3,04
EER <sub>CONDITION B</sub> [74%]			3,95	4,01	3,99	4,02	3,93	3,95	3,89	3,82	3,98	4,10	4,14	4,20
EER <sub>CONDITION C</sub> [47%]			4,66	4,81	4,81	5,03	4,76	4,66	4,72	4,68	4,72	5,10	5,06	5,02
EER <sub>CONDITION D</sub> [21%]			6,14	6,31	6,33	6,65	6,62	6,23	6,62	6,32	6,22	6,69	6,70	6,68
<b>SEER <sup>2)3)</sup></b>			<b>4,53</b>	<b>4,64</b>	<b>4,65</b>	<b>4,80</b>	<b>4,66</b>	<b>4,56</b>	<b>4,62</b>	<b>4,56</b>	<b>4,60</b>	<b>4,87</b>	<b>4,86</b>	<b>4,85</b>
$\eta_{s,c}$ <sup>2)3)</sup>	%		<b>178</b>	<b>182</b>	<b>183</b>	<b>189</b>	<b>183</b>	<b>179</b>	<b>182</b>	<b>179</b>	<b>181</b>	<b>192</b>	<b>191</b>	<b>191</b>
Number of refrigerant circuits			2	2	2	2	2	2	2	2	2	2	2	2
Total capacity steps <sup>4)</sup>	%		22% ÷ 100%	18% ÷ 100%	16% ÷ 100%	14% ÷ 100%	13% ÷ 100%	15% ÷ 100%	13% ÷ 100%	14% ÷ 100%	13% ÷ 100%	17% ÷ 100%	15% ÷ 100%	14% ÷ 100%
Sound power <sup>5)</sup>	dB(A)		97	98	100	100	100	101	101	102	102	103	103	103
Sound power <sup>5)**/**</sup>	dB(A)		102	103	104	104	104	105	105	106	106	107	108	108
Sound pressure at 10 m <sup>6)</sup>	dB(A)		65	66	68	68	68	68	68	69	69	70	70	70
Sound pressure at 10 m <sup>6)**/**</sup>	dB(A)		70	71	72	72	72	72	72	73	73	74	75	75
<b>ECOi-W SW-N EVO 380-1260 C S - chiller</b>			<b>380</b>	<b>440</b>	<b>510</b>	<b>590</b>	<b>660</b>	<b>730</b>	<b>810</b>	<b>900</b>	<b>980</b>	<b>1060</b>	<b>1160</b>	<b>1260</b>
Nominal cooling capacity <sup>1)</sup>	kW		362,8	441,8	498,2	563,1	640,0	702,5	775,9	893,1	980,9	1045,5	1150,6	1234,8
Input power <sup>1)</sup>	kW		126,1	144,9	168,0	184,0	209,3	231,5	256,4	294,7	326,4	335,5	375,0	416,8
EER <sup>1)</sup>			2,88	3,05	2,97	3,06	3,06	3,03	3,03	3,03	3,01	3,12	3,07	2,96
EER <sub>CONDITION B</sub> [74%]			3,90	4,03	3,99	4,00	3,96	3,97	4,01	3,84	4,18	4,15	4,22	4,31
EER <sub>CONDITION C</sub> [47%]			4,69	5,04	5,05	5,21	4,95	4,91	4,98	4,94	5,02	5,24	5,36	5,30
EER <sub>CONDITION D</sub> [21%]			6,44	6,82	6,75	6,92	6,93	6,64	6,71	6,60	6,55	7,00	7,24	7,04
<b>SEER <sup>2)3)</sup></b>			<b>4,56</b>	<b>4,82</b>	<b>4,79</b>	<b>4,89</b>	<b>4,78</b>	<b>4,73</b>	<b>4,77</b>	<b>4,69</b>	<b>4,82</b>	<b>4,98</b>	<b>5,07</b>	<b>5,03</b>
$\eta_{s,c}$ <sup>2)3)</sup>	%		<b>180</b>	<b>190</b>	<b>189</b>	<b>193</b>	<b>188</b>	<b>186</b>	<b>188</b>	<b>185</b>	<b>190</b>	<b>196</b>	<b>200</b>	<b>198</b>
Number of refrigerant circuits			2	2	2	2	2	2	2	2	2	2	2	2
Total capacity steps <sup>4)</sup>	%		22% ÷ 100%	18% ÷ 100%	16% ÷ 100%	14% ÷ 100%	13% ÷ 100%	15% ÷ 100%	13% ÷ 100%	14% ÷ 100%	13% ÷ 100%	17% ÷ 100%	15% ÷ 100%	14% ÷ 100%
Sound power <sup>5)</sup>	dB(A)		94	94	97	97	97	98	98	99	99	99	100	100
Sound pressure at 10 m <sup>6)</sup>	dB(A)		62	62	65	65	65	65	65	66	66	66	67	67

Physical features

<b>ECOi-W SW-N EVO 380-1260 C - chiller</b>		<b>380</b>	<b>440</b>	<b>510</b>	<b>590</b>	<b>660</b>	<b>730</b>	<b>810</b>	<b>900</b>	<b>980</b>	<b>1060</b>	<b>1160</b>	<b>1260</b>	
Dimension	Height	mm	2510	2510	2510	2510	2510	2510	2510	2510	2510	2510	2510	
	Height S	mm	2590	2590	2590	2590	2590	2590	2590	2590	2590	2590	2590	
	Width	mm	2192	2192	2192	2192	2192	2192	2192	2192	2192	2192	2192	
	Length	mm	4660	5712	5712	6764	7816	7816	8868	9920	10972	12024	13076	13076
Operating weight	STD / HT / HP	kg	3896	4259	4897	5241	5620	6207	6531	7326	7764	8491	8875	9074
	S	kg	3981	4352	4990	5323	5702	6293	6617	7412	7852	8579	8963	9162

1) Data refers to 7 °C leaving chilled water temperature and 35 °C condenser air temperature, according EN 14511-2013 standard. 2) ErP compliant: following COMMISSION REGULATION (EU) 2016/2281. 3) According EN 14825. 4) This value can change for BC version or other special applications. 5) Sound levels are at fully loaded conditions. Sound power values refer to ISO standard 3744, parallelepiped shape. \* High temperature units (HT), data with fans at maximum speed (1100 r.p.m.). \*\* HPF units, data with fans at maximum speed (1100 r.p.m.).

Technological innovation - All-round variable volume flow management.

Refrigerant.

Inverter driven compressor technology and electronic expansion valve.



Air.

EC brushless fan motor technology.



Water.

Inverter driven pump technology.

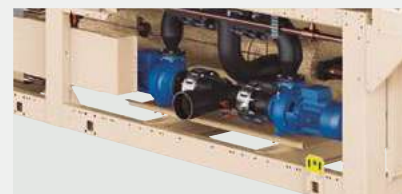

Improved part load efficiency.  
Continuous capacity control.  
Flexible offer in plant integration.



## Water cooled chillers, heat pumps and condenserless units

Quality and comfort for all your projects with ECOi-W units! Perfect for any type of building, the system consists of water cooled chillers or heat pumps that provide cold or hot water to water terminals. This system is particularly well suited for applications such as office buildings, hotels, shopping centers and hospitals.



Water cooled chillers ECOi-W use water as the cooling medium to extract heat from the cooling circuit by cooling and condensing the refrigerant.

**Advantages:**

- Higher cooling efficiency compared to air cooled chillers
- Less impact on the environment with less waste heat or fan noise

\* The below illustration show cooling application.

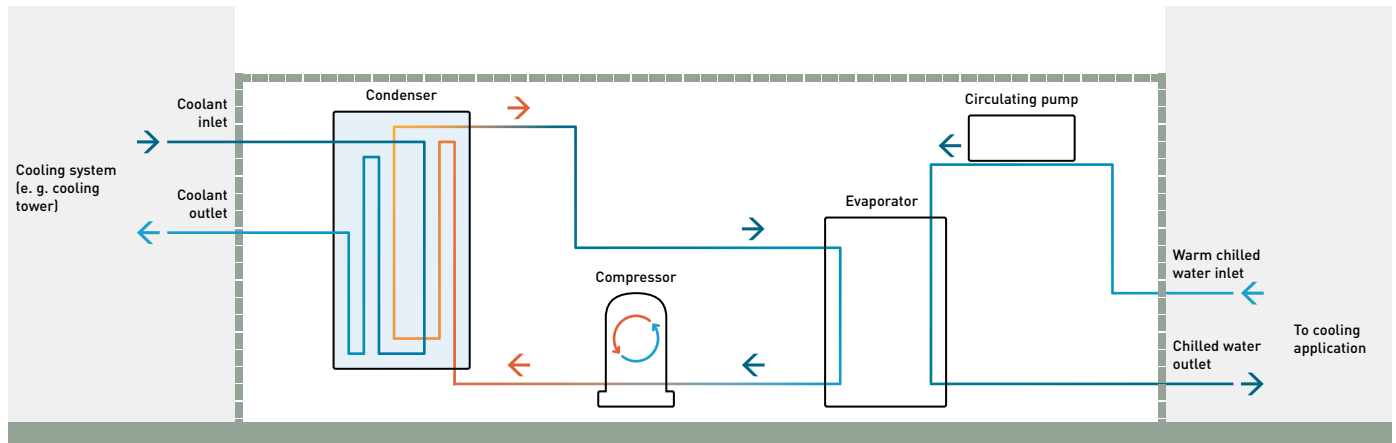

**Ecodesign**

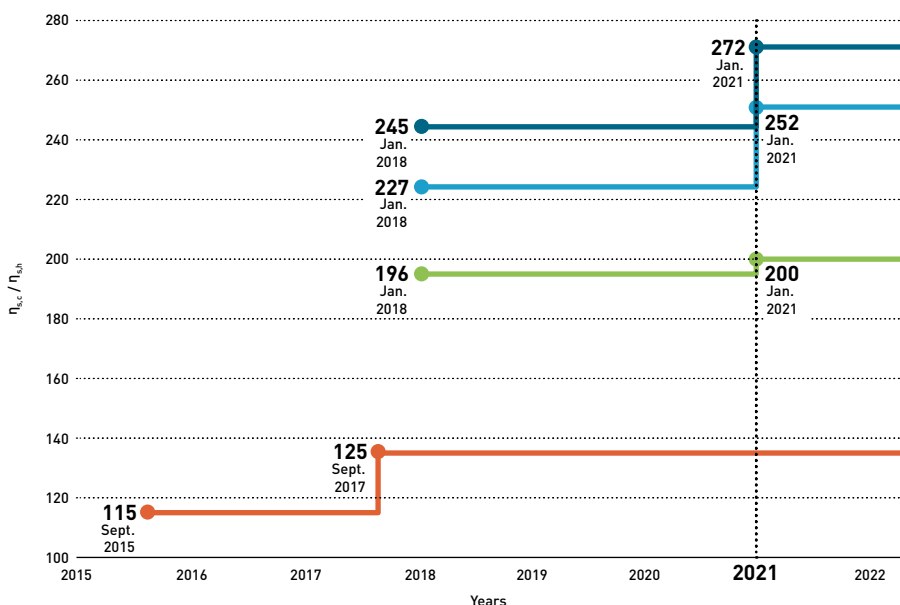

**Water to water comfort chiller <sup>1)</sup>**

<p>≤400 kW. Minimum η<sub>ec</sub> to be Ecodesign compliant. COMMISSION REGULATION (EU) 2016/2281.</p>	<p>&gt;400 kW and ≤1500 kW. Minimum η<sub>ec</sub> to be Ecodesign compliant. COMMISSION REGULATION (EU) 2016/2281.</p>	<p>&gt;1500 kW. Minimum η<sub>ec</sub> to be Ecodesign compliant. COMMISSION REGULATION (EU) 2016/2281.</p>
---	---	---

**Water to water heat pumps <sup>2)</sup>**

<p>≤400 kW. Minimum η<sub>sh</sub> to be Ecodesign compliant. COMMISSION REGULATION (EU) No 813/2013.</p>	<p>&gt;400 kW and ≤1500 kW. Minimum η<sub>sh</sub> to be Ecodesign compliant. COMMISSION REGULATION (EU) 2016/2281.</p>	<p>&gt;1500 kW. Minimum η<sub>sh</sub> to be Ecodesign compliant. COMMISSION REGULATION (EU) 2016/2281.</p>
---	---	---





1) Calculated at nominal conditions: chilled water inlet/outlet temperature: 12/7 °C, outdoor ambient temperature 30/35 °C DB.

2) Rated heat output of space heaters and combination heaters at reference design conditions [T<sub>design</sub> -10 °C] as stated in COMMISSION REGULATION (EU) No 813/2013.

# Quick selection guide - Water cooled chillers

Page	Size	Cooling capacity (kW)	SEER	Sound power (dB(A))	Dimension LxHxW (mm)
P. 522	20	21,2	5,58	65	821 x 1350 x 455
	25	26,2	5,60	67	821 x 1350 x 455
	30	31,1	5,45	67	821 x 1350 x 455
	35	34,8	5,50	68	821 x 1350 x 455
	40	39,2	5,35	68	821 x 1350 x 455
	45	46,6	5,83	70	821 x 1350 x 455
P. 522	50	50,9	6,13	70	1210 x 1500 x 850
	60	61,1	6,38	70	1210 x 1500 x 850
	75	77,3	5,95	72	1210 x 1500 x 850
	90	91,1	6,70	73	1210 x 1500 x 850
	120	118,4	5,90	78	1210 x 1500 x 850
	150	147,1	6,13	81	1210 x 1500 x 850
P. 524	170	170	6,08	81	1210 x 1500 x 850
	190	192,7	6,20	81	1210 x 1500 x 850
	524	154,3	5,55	81	2250 x 1845 x 850
	604	181,8	6,28	82	2250 x 1845 x 850
	704	208,9	6,10	85	2250 x 1845 x 850
	804	232,6	5,75	87	2250 x 1845 x 850
P. 524	904	265,8	6,10	89	2250 x 1845 x 850
	1004	295,6	6,10	90	2250 x 1845 x 850
	1104	338	6,20	90	2250 x 1845 x 850
	1204	379,2	6,25	90	2250 x 1845 x 850
	1404	421,1	6,43	92	2250 x 1845 x 850
	1604	459,8	6,47	94	2250 x 1845 x 850
P. 526	440	418,6	6,38	95	4250 x 1650 x 1350
	490	471,6	6,38	95	4250 x 1650 x 1350
	570	539,3	6,52	95	4210 x 1650 x 1350
	630	601,9	6,42	95	4210 x 1650 x 1350
	700	664,4	6,38	95	4180 x 1650 x 1350
	770	734,6	6,38	95	4180 x 1650 x 1350
P. 526	860	825,0	6,41	98	4510 x 1710 x 1520
	920	874,1	6,41	98	4510 x 1710 x 1520
	990	936,6	6,41	98	4600 x 1710 x 1520
	1070	1019,1	6,42	98	4650 x 1710 x 1520
	1130	1071,8	6,53	98	4650 x 1710 x 1520
	1220	1159,3	6,51	98	4650 x 1710 x 1520
P. 526	1280	1226,1	6,44	98	4650 x 1710 x 1520
	1400	1334,6	6,45	98	5350 x 1710 x 1520
	1550	1457,9	6,42	98	5350 x 1710 x 1520

# Quick selection guide - Water cooled heat pumps

Page	Size	Cooling and heating capacity (kW)	SEER / SCOP	Sound power (dB(A))	Dimension LxHxW (mm)	
P. 522		20	20,8 / 23,7	5,13 / 5,17	65	821 x 1350 x 455
		25	26,0 / 28,9	5,00 / 5,45	67	821 x 1350 x 455
		30	30,1 / 33,6	4,88 / 5,33	67	821 x 1350 x 455
		35	34,0 / 38,5	5,10 / 5,05	68	821 x 1350 x 455
		40	38,2 / 42,9	5,00 / 4,83	68	821 x 1350 x 455
		45	45,5 / 51,2	5,47 / 5,28	70	821 x 1350 x 455
P. 522		50	49,9 / 57,7	4,70 / 5,70	70	1210 x 1500 x 850
		60	58,9 / 68,2	4,88 / 5,88	70	1210 x 1500 x 850
		75	76,1 / 86,3	4,47 / 5,70	72	1210 x 1500 x 850
		90	88,6 / 102,2	4,83 / 5,78	73	1210 x 1500 x 850
		120	114,9 / 132	4,92 / 5,75	78	1210 x 1500 x 850
		150	144,3 / 164,2	4,97 / 5,63	81	1210 x 1500 x 850
		170	165,7 / 190,1	5,65 / 5,95	81	1210 x 1500 x 850
		190	185,4 / 212,3	5,10 / 5,63	81	1210 x 1500 x 850
P. 524		524	150,7 / 170,2	4,65 / 5,40	81	2250 x 1845 x 850
		604	176,2 / 201,1	4,92 / 5,20	82	2250 x 1845 x 850
		704	204,5 / 231,8	4,92 / 5,38	85	2250 x 1845 x 850
		804	225,4 / 256,5	4,68 / 5,35	87	2250 x 1845 x 850
		904	263,1 / 295,6	5,15 / 5,73	89	2250 x 1845 x 850
		1004	291,3 / 331	5,10 / 5,85	90	2250 x 1845 x 850
		1104	332 / 376,6	5,27 / 5,83	90	2250 x 1845 x 850
		1204	370,5 / 418,5	5,30 / 5,85	90	2250 x 1845 x 850
		1404	421,1 / 468,0	6,43 / —	92	2250 x 1845 x 850
		1604	459,8 / 508,4	6,47 / —	94	2250 x 1845 x 850
P. 526		440	365,9 / 470,3	6,53 / 4,46	95	4590 x 1650 x 1450
		490	418,9 / 536,5	6,38 / 4,52	95	4590 x 1650 x 1450
		570	483,2 / 621,7	6,40 / 4,4	95	4630 x 1650 x 1450
		630	541,0 / 698,6	6,38 / 4,31	95	4630 x 1650 x 1450
		700	595,6 / 764,7	6,45 / 4,47	95	4320 x 1650 x 1450
		770	646,6 / 835,9	6,60 / 4,37	95	4560 x 1650 x 1450
		860	715,5 / 923,0	6,40 / 4,39	98	5110 x 1680 x 1520
		920	772,0 / 992,7	6,50 / 4,44	98	5110 x 1680 x 1520
		990	828,1 / 1063,0	6,40 / 4,49	98	5100 x 1680 x 1520
		1070	891,5 / 1146,0	6,40 / 4,45	98	5100 x 1680 x 1520
		1130	958,8 / 1231,8	6,50 / 4,45	98	5000 x 1680 x 1520
		1220	1023,8 / 1315,8	6,48 / 4,41	98	5000 x 1680 x 1520
		1280	1078,2 / 1386,1	6,48 / 4,37	98	5000 x 1680 x 1520
		1400	1186,9 / 1523,8	6,50 / 4,45	98	5300 x 1710 x 1580
		1550	1285,5 / 1654,6	6,70 / 4,38	98	5300 x 1710 x 1580

# Quick selection guide - Water cooled condenserless units

Page	Size	Cooling capacity (kW)	Sound power (dB(A))	Dimension LxWxH (mm)
P. 522	20	18,3	65	821 x 1350 x 455
	25	22,7	67	821 x 1350 x 455
	30	27,1	67	821 x 1350 x 455
	35	30,0	68	821 x 1350 x 455
	40	34,2	68	821 x 1350 x 455
	45	43,1	70	821 x 1350 x 455
P. 522	50	45,0	70	1210 x 1500 x 850
	60	53,4	70	1210 x 1500 x 850
	75	67,5	72	1210 x 1500 x 850
	90	80,1	73	1210 x 1500 x 850
	120	104,0	78	1210 x 1500 x 850
	150	128,0	81	1210 x 1500 x 850
P. 524	170	148,0	81	1210 x 1500 x 850
	190	168,0	81	1210 x 1500 x 850
	524	130,0	81	2250 x 1845 x 850
	604	155,3	82	2250 x 1845 x 850
	704	177,6	85	2250 x 1845 x 850
	804	196,5	87	2250 x 1845 x 850
	904	224,2	89	2250 x 1845 x 850
	1004	247,2	90	2250 x 1845 x 850
	1104	285,9	90	2250 x 1845 x 850
	1204	316,1	90	2250 x 1845 x 850
P. 526	1404	368,0	92	2250 x 1845 x 850
	1604	397,0	94	2250 x 1845 x 850
	440	358,6	95	4590 x 1650 x 1450
	490	405,3	95	4590 x 1650 x 1450
	570	472,7	95	4630 x 1650 x 1450
	630	535,6	95	4630 x 1650 x 1450
	700	586,2	95	4320 x 1650 x 1450
	770	638,1	95	4560 x 1650 x 1450
	860	708,9	98	5110 x 1680 x 1520
	920	758,1	98	5110 x 1680 x 1520
P. 526	990	817,2	98	5100 x 1680 x 1520
	1070	886,2	98	5100 x 1680 x 1520
	1130	947,7	98	5000 x 1680 x 1520
	1220	1015,0	98	5000 x 1680 x 1520
	1280	1075,9	98	5000 x 1680 x 1520
	1400	1181,4	98	5300 x 1710 x 1580
	1550	1277,8	98	5300 x 1710 x 1580



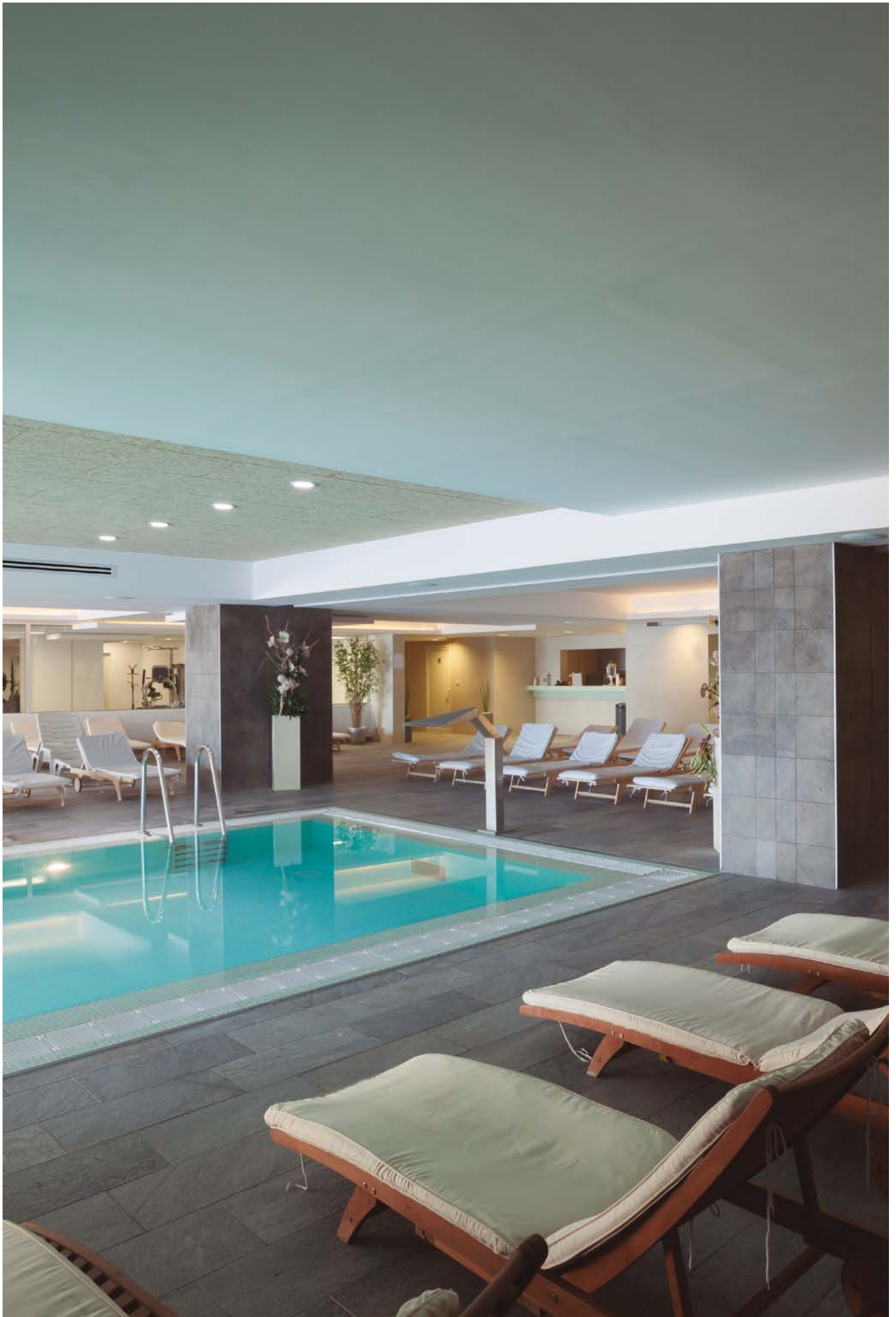



# ECOi-W WQ 20-190 C/H/R · R410A

Water cooled chillers, heat pumps and condenserless units.

Cooling capacity: 21,2 to 192,7 kW.

Heating capacity: 23,7 to 212,3 kW.



## Operating limits

To be confirmed with AC SELECT:  
<https://acselect.panasonic.eu/>

Leaving water temperature.

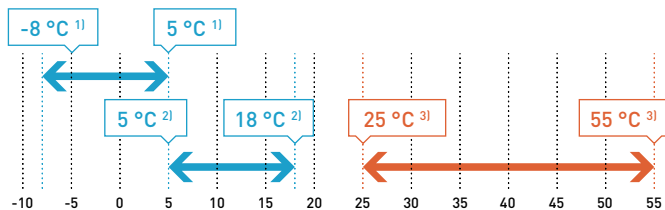

1) With glycol + EEV.

2) Without glycol + EEV.

3) Only C/H types 20-190.

Note: maximum % glycol (ethylenic or propylenic): 40%.

## ECOi-W WQ 20-190 C/H/R

Cooling	Leaving water temperature	$\Delta T$	K	From 3 to 8
Heating <sup>1)</sup>	Leaving water temperature	$\Delta T$	K	From 3 to 15

1) Only C/H types 20-190.

## Accessories supplied loose

<b>P-348089</b>	Valves in - out for sizes 20-45
<b>P-376463</b>	Sequencer for up to 4 chillers installation
<b>P-348682</b>	Water temperature sensor for second set-point zone
<b>P-347940</b>	Remote ON / OFF control
<b>P-348684</b>	Remote keyboard panel
<b>P-365581</b>	Flow switch [operational only on the evaporator side]
<b>P-473465</b>	Pressure switch

## The range at a glance

- 3 versions: C (chiller), H (heat pump) and R (condenserless unit)
- 14 sizes
- 2 acoustic options: STD (standard) and S (super low noise)
- 2 frames: F1 (size from 20 to 45) and F2 (size from 50 to 190)

## Advantages

- High full load efficiency: EER up to 4,50, COP up to 3,90
- High seasonal performances: SEER up to 6,70
- Compressor box: remarkable sound reduction
- Reduced refrigerant charge: less than 10 kg per circuit for units up to size 90
- Advanced electronic controller: auto-adaptive function to reduce water content in the piping system
- Condensing pressure control option suitable for well application
- Wide range of Plug & Play hydrokit: easy hydraulic installation
- DHW function available on the controller with DHW probe and 3 way valve available as options
- Desuperheater heat exchanger available as option (50-190 sizes)

## Equipment

- 1 refrigerant circuit
- 1 or 2 scroll compressors
- Plate evaporator (AISI 316)
- Compressor acoustic box (standard on S)
- Differential pressure switch
- Electronic expansion valve (standard C type 170-190)
- Phase sequence control

## Accessories and options

Compressor jackets
Desuperheater available for sizes 50-190
Hydrokit with 1 or 2 pumps for evaporator and condenser
Mechanical gauges kit
Modbus communication protocol
Power factor corrector capacitors
Soft starter

## Accessories supplied loose

<b>P-348612</b>	Water filter for sizes 20-45
<b>P-348615</b>	Water filter for sizes 50-120
<b>P-348619</b>	Water filter for sizes 150-190
<b>P-348144</b>	3 way valve for DHW production - ON / OFF - DN 20 for sizes 20-45
<b>P-348145</b>	3 way valve for DHW production - ON / OFF - DN 20 for sizes 50-90
<b>P-348143</b>	3 way valve for DHW production - ON / OFF - DN 20 for sizes 120-190



Technical performance

	Voltage	V	400	400	400	400	400	400	400	400	400	400	400	400	400	
Power supply	Phase		Three phase	Three phase	Three phase	Three phase	Three phase	Three phase	Three phase	Three phase	Three phase	Three phase	Three phase	Three phase	Three phase	
	Frequency	Hz	50	50	50	50	50	50	50	50	50	50	50	50	50	
<b>Size</b>			<b>20</b>	<b>25</b>	<b>30</b>	<b>35</b>	<b>40</b>	<b>45</b>	<b>50</b>	<b>60</b>	<b>75</b>	<b>90</b>	<b>120</b>	<b>150</b>	<b>170</b>	<b>190</b>
<b>ECOi-W WQ 20-190 C - chiller</b>	<b>P-WQE****CA</b>		<b>0020</b>	<b>0025</b>	<b>0030</b>	<b>0035</b>	<b>0040</b>	<b>0045</b>	<b>0050</b>	<b>0060</b>	<b>0075</b>	<b>0090</b>	<b>0120</b>	<b>0150</b>	<b>0170</b>	<b>0190</b>
Cooling capacity <sup>1)</sup>	kW		21,2	26,2	31,1	34,8	39,2	46,6	50,9	61,1	77,3	91,1	118,4	147,1	170,0	192,7
Input power <sup>1)</sup>	kW		4,56	5,67	6,84	7,54	8,60	10,1	11,7	13,5	17,1	20,7	26,5	33,0	37,7	42,8
EER <sup>1)</sup>			4,67	4,65	4,57	4,64	4,58	4,65	4,35	4,53	4,52	4,40	4,48	4,47	4,51	4,51
<b>SEER <sup>2)3)</sup></b>			<b>5,58</b>	<b>5,6</b>	<b>5,45</b>	<b>5,5</b>	<b>5,35</b>	<b>5,83</b>	<b>6,13</b>	<b>6,38</b>	<b>5,95</b>	<b>6,7</b>	<b>5,90</b>	<b>6,13</b>	<b>6,08</b>	<b>6,2</b>
<b>η<sub>s,c</sub> <sup>2)3)</sup></b>			<b>220</b>	<b>221</b>	<b>215</b>	<b>217</b>	<b>211</b>	<b>230</b>	<b>242</b>	<b>252</b>	<b>235</b>	<b>265</b>	<b>233</b>	<b>242</b>	<b>240</b>	<b>245</b>
Sound power (STD / S) <sup>4)</sup>	dB(A)		65 / 62	67 / 64	67 / 64	68 / 65	68 / 66	70 / 67	70 / 68	70 / 68	72 / 70	73 / 71	78 / 76	81 / 79	81 / 79	81 / 79
Sound pressure at 10 m (STD / S) <sup>5)</sup>	dB(A)		34 / 31	36 / 33	36 / 33	37 / 34	38 / 35	39 / 36	39 / 37	39 / 37	40 / 39	42 / 40	47 / 45	50 / 48	50 / 48	50 / 48
<b>ECOi-W WQ 20-190 H - heat pump</b>	<b>P-WQE****HA</b>		<b>0020</b>	<b>0025</b>	<b>0030</b>	<b>0035</b>	<b>0040</b>	<b>0045</b>	<b>0050</b>	<b>0060</b>	<b>0075</b>	<b>0090</b>	<b>0120</b>	<b>0150</b>	<b>0170</b>	<b>0190</b>
Cooling capacity <sup>1)</sup>	kW		20,8	26,1	30,2	34,1	38,3	45,7	49,9	58,9	76,1	88,6	114,9	144,3	165,7	185,4
Input power <sup>1)</sup>	kW		4,61	5,71	6,90	7,68	8,69	10,2	12,0	13,9	17,5	21,1	27,0	33,3	38,2	43,3
EER <sup>1)</sup>			4,52	4,56	4,37	4,44	4,41	4,46	4,23	4,31	4,42	4,25	4,31	4,36	4,37	4,30
<b>SEER <sup>2)</sup></b>			<b>5,13</b>	<b>5</b>	<b>4,88</b>	<b>5,1</b>	<b>5</b>	<b>5,48</b>	<b>4,7</b>	<b>4,88</b>	<b>4,47</b>	<b>4,83</b>	<b>4,92</b>	<b>4,97</b>	<b>5,65</b>	<b>5,1</b>
<b>η<sub>s,c</sub> <sup>2)</sup></b>			<b>202</b>	<b>197</b>	<b>192</b>	<b>201</b>	<b>197</b>	<b>216</b>	<b>185</b>	<b>192</b>	<b>176</b>	<b>190</b>	<b>194</b>	<b>196</b>	<b>223</b>	<b>201</b>
Heating capacity <sup>6)</sup>	kW		23,9	29,1	34,0	38,8	43,3	51,5	58,8	65,9	87,7	104	134	167	193	215
Input power <sup>6)</sup>	kW		5,77	7,06	8,36	9,50	10,6	12,5	14,1	16,8	20,8	24,9	32,1	39,4	45,9	51,4
COP <sup>6)</sup>			4,13	4,13	4,07	4,09	4,08	4,11	4,16	3,93	4,22	4,16	4,17	4,23	4,20	4,19
COP <sup>7)</sup>			5,66	5,62	5,58	5,60	5,52	5,24	5,32	5,12	5,43	5,23	5,29	5,38	5,33	5,33
<b>SCOP <sup>8)9)</sup></b>			<b>5,30</b>	<b>5,45</b>	<b>5,33</b>	<b>5,05</b>	<b>4,83</b>	<b>5,28</b>	<b>5,70</b>	<b>5,88</b>	<b>5,70</b>	<b>5,78</b>	<b>5,75</b>	<b>5,63</b>	<b>5,95</b>	<b>5,63</b>
<b>Energy efficiency class <sup>8)9)</sup></b>	<b>A+++ to D</b>	<b>A+++</b>	<b>A+++</b>	<b>A+++</b>	<b>A+++</b>	<b>A+++</b>	<b>A+++</b>	<b>A+++</b>	<b>A+++</b>	<b>A+++</b>	<b>A+++</b>	<b>A+++</b>	<b>A+++</b>	<b>A+++</b>	<b>A+++</b>	<b>A+++</b>
<b>η<sub>s,h</sub> <sup>8)9)</sup></b>			<b>204</b>	<b>210</b>	<b>205</b>	<b>194</b>	<b>185</b>	<b>203</b>	<b>220</b>	<b>227</b>	<b>220</b>	<b>223</b>	<b>222</b>	<b>217</b>	<b>230</b>	<b>217</b>
<b>SCOP <sup>8)10)</sup></b>			<b>4,00</b>	<b>4,48</b>	<b>4,45</b>	<b>4,30</b>	<b>4,28</b>	<b>4,45</b>	<b>4,63</b>	<b>4,78</b>	<b>4,75</b>	<b>4,75</b>	<b>4,73</b>	<b>4,48</b>	<b>4,88</b>	<b>4,68</b>
<b>Energy efficiency class <sup>8)10)</sup></b>	<b>A+++ to D</b>	<b>A+++</b>	<b>A+++</b>	<b>A+++</b>	<b>A+++</b>	<b>A+++</b>	<b>A+++</b>	<b>A+++</b>	<b>A+++</b>	<b>A+++</b>	<b>A+++</b>	<b>A+++</b>	<b>A+++</b>	<b>A+++</b>	<b>A+++</b>	<b>A+++</b>
<b>η<sub>s,h</sub> <sup>8)10)</sup></b>			<b>152</b>	<b>171</b>	<b>170</b>	<b>164</b>	<b>163</b>	<b>170</b>	<b>177</b>	<b>183</b>	<b>182</b>	<b>182</b>	<b>181</b>	<b>171</b>	<b>187</b>	<b>179</b>
Sound power (STD / S) <sup>4)</sup>	dB(A)		65 / 62	67 / 64	67 / 64	68 / 65	69 / 66	70 / 67	70 / 68	70 / 68	72 / 70	73 / 71	78 / 76	81 / 79	81 / 79	81 / 79
Sound pressure at 10 m (STD / S) <sup>5)</sup>	dB(A)		34 / 31	36 / 33	36 / 33	37 / 34	38 / 35	39 / 36	39 / 37	39 / 37	40 / 39	42 / 40	47 / 45	50 / 48	50 / 48	50 / 48
<b>ECOi-W WQ 20-190 R - condenserless unit</b>	<b>P-WQE****RA</b>		<b>0020</b>	<b>0025</b>	<b>0030</b>	<b>0035</b>	<b>0040</b>	<b>0045</b>	<b>0050</b>	<b>0060</b>	<b>0075</b>	<b>0090</b>	<b>0120</b>	<b>0150</b>	<b>0170</b>	<b>0190</b>
Cooling capacity <sup>11)</sup>	kW		18,3	22,7	27,1	30,0	34,2	43,1	45,0	53,4	67,5	80,1	104,0	128,0	148,0	168,0
Input power <sup>11)</sup>	kW		5,70	6,97	8,07	9,15	10,1	12,2	13,7	16	20,1	23,9	30,8	38,1	44,2	49,7
Sound power (STD / S) <sup>4)</sup>	dB(A)		65/62	67 / 64	67 / 64	68 / 65	69 / 66	70 / 67	70 / 68	70 / 68	72 / 70	73 / 71	78 / 76	81 / 79	81 / 79	81 / 79
Sound pressure at 10 m (STD / S) <sup>5)</sup>	dB(A)		34/31	36 / 33	36 / 33	37 / 34	38 / 35	39 / 36	39 / 37	39 / 37	41 / 39	42 / 40	47 / 45	50 / 48	50 / 48	50 / 48

Physical features

<b>ECOi-W WQ 20-190 C/H - chiller / heat pump</b>			<b>20</b>	<b>25</b>	<b>30</b>	<b>35</b>	<b>40</b>	<b>45</b>	<b>50</b>	<b>60</b>	<b>75</b>	<b>90</b>	<b>120</b>	<b>150</b>	<b>170</b>	<b>190</b>
Dimension	Height	mm	1350	1350	1350	1350	1350	1350	1500	1500	1500	1500	1500	1500	1500	1500
	Width	mm	455	455	455	455	455	455	850	850	850	850	850	850	850	850
	Length	mm	821	821	821	821	821	821	1210	1210	1210	1210	1210	1210	1210	1210
Operating weight	Chiller	kg	162	182	179	185	191	214	352	371	392	411	597	666	701	745
	Heat pump	kg	165	187	184	190	195	219	360	379	403	422	610	683	718	762
<b>Water connections (evaporator and condenser)</b>																
Connection type		Victaulic®	Victaulic®	Victaulic®	Victaulic®	Victaulic®	Victaulic®	Victaulic®	Victaulic®	Victaulic®	Victaulic®	Victaulic®	Victaulic®	Victaulic®	Victaulic®	Victaulic®
Inlet/outlet diameter	Inch	1 ½	1 ½	1 ½	1 ½	1 ½	1 ½	2 ½	2 ½	2 ½	2 ½	2 ½	2 ½	2 ½	2 ½	2 ½
<b>ECOi-W WQ 20-190 R - condenserless unit</b>			<b>20</b>	<b>25</b>	<b>30</b>	<b>35</b>	<b>40</b>	<b>45</b>	<b>50</b>	<b>60</b>	<b>75</b>	<b>90</b>	<b>120</b>	<b>150</b>	<b>170</b>	<b>190</b>
Dimension	Height	mm	1350	1350	1350	1350	1350	1350	1500	1500	1500	1500	1500	1500	1500	1500
	Width	mm	455	455	455	455	455	455	850	850	850	850	850	850	850	850
	Length	mm	821	821	821	821	821	821	1210	1210	1210	1210	1210	1210	1210	1210
Operating weight	kg	144	164	166	166	172	172	332	344	365	376	558	612	643	674	
<b>Water connections (evaporator)</b>																
Connection type		Victaulic®	Victaulic®	Victaulic®	Victaulic®	Victaulic®	Victaulic®	Victaulic®	Victaulic®	Victaulic®	Victaulic®	Victaulic®	Victaulic®	Victaulic®	Victaulic®	Victaulic®
Inlet/outlet diameter	Inch	1 ½	1 ½	1 ½	1 ½	1 ½	1 ½	2 ½	2 ½	2 ½	2 ½	2 ½	2 ½	2 ½	2 ½	2 ½
<b>Remote condenser refrigerant connections</b>																
Connection type		To be brazed	To be brazed	To be brazed	To be brazed	To be brazed	To be brazed	To be brazed	To be brazed	To be brazed	To be brazed	To be brazed	To be brazed	To be brazed	To be brazed	To be brazed
Inlet diameter	Inch	5/8	5/8	5/8	5/8	5/8	5/8	5/8	5/8	5/8	7/8	7/8	7/8	7/8	1 1/8	1 1/8
Outlet diameter	Inch	5/8	7/8	7/8	7/8	7/8	7/8	7/8	7/8	7/8	1 1/8	1 1/8	1 3/8	1 5/8	1 5/8	1 5/8

1) According to EN 14511 standard: evaporator EWT/LWT 12 °C/7 °C, condenser EWT/LWT 30 °C/35 °C. 2) According to EN 14825 standard. 3) ErP compliant: following COMMISSION REGULATION (EU) 2016/2281. 4) Sound levels are at fully loaded conditions. Sound power values refers to ISO 3744 standard. 5) Sound pressures refer to ISO 3744 standard, parallelepiped shape. 6) According to EN 14511 standard: evaporator EWT/LWT 10 °C/7 °C, condenser EWT/LWT 40 °C/45 °C. 7) According to EN 14511 standard: evaporator EWT/LWT 10 °C/7 °C, condenser EWT/LWT 30 °C/35 °C. 8) ErP compliant: following COMMISSION REGULATION (EU) No 813/2013. 9) According to EN 14825 standard - low temperature application [35 °C]. 10) According to EN 14825 standard - medium temperature application [55 °C]. 11) Data refers to evaporator water temperature 12/7 °C and condensing temperature 50 °C.

ErP

HIGH SEER  
6,70

HIGH SCOP  
5,88

WATER COOLED

PLATE HEAT EXCHANGER

SCROLL COMPRESSOR

SUPER QUIET

VERY HIGH PERFORMANCE





# ECOi-W WQ 524-1604 C/H/R - R410A

Water cooled chillers, heat pumps and condenserless units.

Cooling capacity: 154,3 to 459,8 kW.

Heating capacity: 170,2 to 508,4 kW.



## The range at a glance

- 3 versions: C (chiller), H (heat pump) and R (condenserless unit)
- 10 sizes
- 2 acoustic options: STD (standard) and S (super low noise)

## Advantages

- High full load efficiency: EER up to 4,50, COP up to 3,90
- High seasonal performances: SEER up to 6,50
- Advanced electronic controller: auto-adaptive function to reduce water content in the piping system
- Condensing pressure control option: suitable for well application
- Wide range of Plug & Play hydrokit: easy hydraulic installation
- Desuperheater heat exchanger available as option: heating capacity for free thanks to heat recovery

## Operating limits

To be confirmed with AC SELECT:  
<https://acselect.panasonic.eu/>

Leaving water temperature.

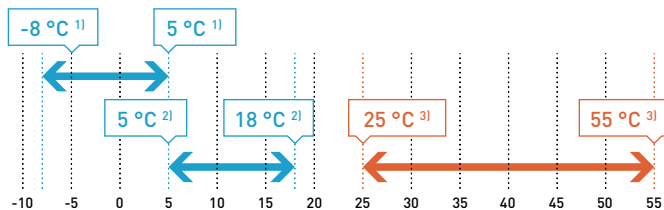

1) With glycol + EEV.

2) Without glycol + EEV.

3) Only C/H types 20-190.

Note: maximum % glycol (ethylenic or propylenic): 40%.

## Equipment

- 2 refrigerant circuits
- 4 scroll compressors (tandem)
- Plate evaporator (AISI 316)
- Differential pressure switch
- Electronic expansion valve (standard 1104-1604)
- Phase sequence control

## Accessories and options

Desuperheater
Hydrokit with 1 or 2 pumps for evaporator and condenser
Mechanical gauges
Modbus communication protocol
Soft starter

## ECOi-W WQ 524-1604 C/H/R

Cooling	Leaving water temperature	$\Delta T$	K	From 3 to 8
Heating	Leaving water temperature	$\Delta T$	K	From 3 to 15

## Accessories supplied loose

<b>P-376463</b>	Sequencer for up to 4 chillers installation
<b>P-347941</b>	Remote ON / OFF control
<b>P-348684</b>	Remote keyboard panel
<b>P-365581</b>	Flow switch (operational only on the evaporator side)

## Accessories supplied loose

<b>P-473465</b>	Pressure switch
<b>P-348619</b>	Water filter for sizes 524-1204
<b>P-348620</b>	Water filter for sizes 1404-1604

## AC SELECT.

Smart and user-friendly selection tool. Configure your air conditioning solution at required conditions:  
<https://acselect.panasonic.eu/>





Technical performance

	Voltage	V	400	400	400	400	400	400	400	400	400	400
Power supply	Phase		Three phase	Three phase	Three phase	Three phase	Three phase	Three phase	Three phase	Three phase	Three phase	Three phase
	Frequency	Hz	50	50	50	50	50	50	50	50	50	50
Size			<b>524</b>	<b>604</b>	<b>704</b>	<b>804</b>	<b>904</b>	<b>1004</b>	<b>1104</b>	<b>1204</b>	<b>1404</b>	<b>1604</b>
<b>ECOi-W WQ 524-1604 C - chiller</b>	<b>P-</b>	<b>WQE0524CA</b>	<b>WQE0604CA</b>	<b>WQE0704CA</b>	<b>WQE0804CA</b>	<b>WQE0904CA</b>	<b>WQE1004CA</b>	<b>WQE1104CA</b>	<b>WQE1204CA</b>	<b>WQE1404CA</b>	<b>WQE1604CA</b>	
Cooling capacity <sup>1)</sup>	kW	154,3	181,8	208,9	232,6	265,8	295,6	338,0	379,2	421,1	459,8	
Input power <sup>1)</sup>	kW	34,9	42,4	48,4	54,4	60,5	69,0	76,4	85,2	97,0	109,0	
EER <sup>1)</sup>		4,42	4,28	4,31	4,27	4,39	4,28	4,42	4,45	4,34	4,19	
<b>SEER <sup>2)3)</sup></b>		<b>5,55</b>	<b>6,28</b>	<b>6,1</b>	<b>5,75</b>	<b>6,1</b>	<b>6,1</b>	<b>6,2</b>	<b>6,25</b>	<b>6,43</b>	<b>6,47</b>	
<b>η<sub>s,c</sub> <sup>2)3)</sup></b>		<b>219</b>	<b>248</b>	<b>241</b>	<b>227</b>	<b>241</b>	<b>241</b>	<b>245</b>	<b>247</b>	<b>254</b>	<b>256</b>	
Sound power (STD / S) <sup>4)</sup>	dB(A)	81 / 75	82 / 76	85 / 79	87 / 81	89 / 83	90 / 84	90 / 84	90 / 84	92 / 86	94 / 88	
Sound pressure at 10 m (STD / S) <sup>5)</sup>	dB(A)	49 / 43	50 / 44	53 / 47	55 / 49	57 / 51	58 / 52	58 / 52	58 / 52	60 / 54	62 / 56	
<b>ECOi-W WQ 524-1604 H - heat pump</b>	<b>P-</b>	<b>WQE0524HA</b>	<b>WQE0604HA</b>	<b>WQE0704HA</b>	<b>WQE0804HA</b>	<b>WQE0904HA</b>	<b>WQE1004HA</b>	<b>WQE1104HA</b>	<b>WQE1204HA</b>	<b>WQE1404HA</b>	<b>WQE1604HA</b>	
Cooling capacity <sup>1)</sup>	kW	150,7	176,2	204,5	225,4	263,1	291,3	332,0	370,5	421,1	459,8	
Input power <sup>1)</sup>	kW	43,6	43,6	49,4	55,5	61,0	67,7	77,7	86,9	97,0	109,0	
EER <sup>1)</sup>		4,04	4,04	4,14	4,06	4,31	4,30	4,27	4,26	4,34	4,19	
<b>SEER <sup>2)</sup></b>		<b>4,65</b>	<b>4,92</b>	<b>4,92</b>	<b>4,68</b>	<b>5,15</b>	<b>5,1</b>	<b>5,27</b>	<b>5,3</b>	<b>6,43</b>	<b>6,47</b>	
<b>η<sub>s,c</sub> <sup>2)</sup></b>		<b>183</b>	<b>194</b>	<b>194</b>	<b>184</b>	<b>203</b>	<b>201</b>	<b>208</b>	<b>209</b>	<b>254</b>	<b>256</b>	
Heating capacity <sup>6)</sup>	kW	172	203	234	259	298	333	380	422	471	509	
Input power <sup>6)</sup>	kW	41,9	50,8	57,6	65,1	72,5	80,8	92,1	103	121	135	
COP <sup>6)</sup>		4,11	4,00	4,07	3,99	4,12	4,12	4,12	4,10	3,91	3,76	
COP <sup>7)</sup>		5,36	5,08	5,25	5,11	5,33	5,44	5,30	5,30	5,08	4,99	
<b>SCOP <sup>8)9)</sup></b>		<b>5,40</b>	<b>5,20</b>	<b>5,38</b>	<b>5,35</b>	<b>5,73</b>	<b>5,85</b>	<b>5,83</b>	<b>5,85</b>	—	—	
<b>η<sub>s,h</sub> <sup>8)9)</sup></b>		<b>208</b>	<b>200</b>	<b>207</b>	<b>206</b>	<b>221</b>	<b>226</b>	<b>225</b>	<b>226</b>	—	—	
<b>SCOP <sup>8)10)</sup></b>		<b>4,55</b>	<b>4,38</b>	<b>4,48</b>	<b>4,43</b>	<b>4,53</b>	<b>4,58</b>	<b>4,60</b>	<b>4,60</b>	—	—	
<b>η<sub>s,h</sub> <sup>8)10)</sup></b>		<b>174</b>	<b>167</b>	<b>171</b>	<b>169</b>	<b>173</b>	<b>175</b>	<b>176</b>	<b>176</b>	—	—	
Sound power (STD / S) <sup>4)</sup>	dB(A)	81 / 75	82 / 76	85 / 79	87 / 81	89 / 83	90 / 84	90 / 84	90 / 84	92 / 86	94 / 88	
Sound pressure at 10 m (STD / S) <sup>5)</sup>	dB(A)	49 / 43	50 / 44	53 / 47	55 / 49	57 / 51	58 / 52	58 / 52	58 / 52	60 / 54	62 / 56	
<b>ECOi-W WQ 524-1604 R - condenserless unit</b>	<b>P-</b>	<b>WQE0524RA</b>	<b>WQE0604RA</b>	<b>WQE0704RA</b>	<b>WQE0804RA</b>	<b>WQE0904RA</b>	<b>WQE1004RA</b>	<b>WQE1104RA</b>	<b>WQE1204RA</b>	<b>WQE1404RA</b>	<b>WQE1604RA</b>	
Cooling capacity <sup>11)</sup>	kW	130,0	155,3	177,6	196,5	224,2	247,2	285,9	316,1	368,0	397,0	
Input power <sup>11)</sup>	kW	43,2	51,5	59,5	66,4	74,8	83	95	106	120	134	
Sound power (STD / S) <sup>4)</sup>	dB(A)	81 / 75	82 / 76	85 / 79	87 / 81	89 / 83	90 / 84	90 / 84	90 / 84	92 / 86	94 / 88	
Sound pressure at 10 m (STD / S) <sup>5)</sup>	dB(A)	49 / 43	50 / 44	53 / 47	55 / 49	57 / 51	58 / 52	58 / 52	58 / 52	60 / 54	62 / 56	

Physical features

<b>ECOi-W WQ 524-1604 C/H/R - chiller / heat pump / condenserless unit</b>			<b>524</b>	<b>604</b>	<b>704</b>	<b>804</b>	<b>904</b>	<b>1004</b>	<b>1104</b>	<b>1204</b>	<b>1404</b>	<b>1604</b>	
Dimension	Height	mm	1845 <sup>12)</sup> / 1880 <sup>13)</sup>	1845 <sup>12)</sup> / 1880 <sup>13)</sup>	1845 <sup>12)</sup> / 1880 <sup>13)</sup>	1845 <sup>12)</sup> / 1880 <sup>13)</sup>	1845 <sup>12)</sup> / 1880 <sup>13)</sup>	1845 <sup>12)</sup> / 1880 <sup>13)</sup>	1845 <sup>12)</sup> / 1880 <sup>13)</sup>	1845 <sup>12)</sup> / 1880 <sup>13)</sup>	1845 <sup>12)</sup> / 1880 <sup>13)</sup>	1845 <sup>12)</sup> / 1880 <sup>13)</sup>	
	Width	mm	850 <sup>12)</sup> / 854 <sup>13)</sup> / 885 <sup>12)14)</sup> - 1005 <sup>13)14)</sup>	850 <sup>12)</sup> / 854 <sup>13)</sup> / 885 <sup>12)14)</sup> - 1005 <sup>13)14)</sup>	850 <sup>12)</sup> / 854 <sup>13)</sup> / 885 <sup>12)14)</sup> - 1005 <sup>13)14)</sup>	850 <sup>12)</sup> / 854 <sup>13)</sup> / 885 <sup>12)14)</sup> - 1005 <sup>13)14)</sup>	850 <sup>12)</sup> / 854 <sup>13)</sup> / 885 <sup>12)14)</sup> - 1005 <sup>13)14)</sup>	850 <sup>12)</sup> / 854 <sup>13)</sup> / 885 <sup>12)14)</sup> - 1005 <sup>13)14)</sup>	850 <sup>12)</sup> / 854 <sup>13)</sup> / 885 <sup>12)14)</sup> - 1005 <sup>13)14)</sup>	850 <sup>12)</sup> / 854 <sup>13)</sup> / 885 <sup>12)14)</sup> - 1005 <sup>13)14)</sup>	850 <sup>12)</sup> / 854 <sup>13)</sup> / 885 <sup>12)14)</sup> - 1005 <sup>13)14)</sup>	850 <sup>12)</sup> / 854 <sup>13)</sup> / 885 <sup>12)14)</sup> - 1005 <sup>13)14)</sup>	850 <sup>12)</sup> / 854 <sup>13)</sup> / 885 <sup>12)14)</sup> - 1005 <sup>13)14)</sup>
			Length	mm	2250	2250	2250	2250	2250	2250	2250	2250	2250
Operating weight - chiller	STD	kg	890	971	1156	1329	1340	1453	1552	1660	1743	1798	
	S	kg	993	1074	1259	1432	1443	1556	1655	1763	1846	1901	
Operating weight - heat pump	STD	kg	909	989	1187	1360	1376	1500	1598	1704	1787	1842	
	S	kg	1012	1092	1290	1463	1479	1603	1701	1807	1890	1945	
Operating weight - condenserless unit	STD	kg	770	812	988	1163	1188	1241	1328	1388	1463	1502	
	S	kg	873	915	1091	1266	1291	1344	1431	1491	1566	1605	

Water connections

Connection type		Victaulic®	Victaulic®	Victaulic®	Victaulic®	Victaulic®	Victaulic®	Victaulic®	Victaulic®	Victaulic®	Victaulic®
Inlet/outlet diameter	Inch	2 1/2	2 1/2	2 1/2	2 1/2	4	4	4	4	4	4

<b>ECOi-W WQ 524-1604 R - condenserless unit</b>	<b>524</b>	<b>604</b>	<b>704</b>	<b>804</b>	<b>904</b>	<b>1004</b>	<b>1104</b>	<b>1204</b>	<b>1404</b>	<b>1604</b>
--	------------	------------	------------	------------	------------	-------------	-------------	-------------	-------------	-------------

Remote condenser refrigerant connections

Connection type		To be brazed	To be brazed	To be brazed	To be brazed	To be brazed	To be brazed	To be brazed	To be brazed	To be brazed	To be brazed
Inlet diameter	Inch	7/8	7/8	1 1/8	1 1/8	1 1/8	1 1/8	1 1/8	1 1/8	1 1/8	1 1/8
Outlet diameter	Inch	1 1/8	1 1/8	1 3/8	1 3/8	1 5/8	1 5/8	1 5/8	1 5/8	1 5/8	1 5/8

1) According to EN 14511 standard: evaporator EWT/LWT 12 °C/7 °C, condenser EWT/LWT 30 °C/35 °C. 2) According to EN 14825 standard. 3) ErP compliant: following COMMISSION REGULATION (EU) 2016/2281. 4) Sound levels are at fully loaded conditions. Sound power values refers to ISO 3744 standard. 5) Sound pressures refer to ISO 3744 standard, parallelepiped shape. 6) According to EN 14511 standard: evaporator EWT/LWT 10 °C/7 °C, condenser EWT/LWT 40 °C/45 °C. 7) According to EN 14511 standard: evaporator EWT/LWT 10 °C/7 °C, condenser EWT/LWT 30 °C/35 °C. 8) ErP compliant: following COMMISSION REGULATION (EU) No 813/2013. 9) According to EN 14825 standard - low temperature application [35 °C]. 10) According to EN 14825 standard - medium temperature application [55 °C]. 11) Data refers to evaporator water temperature 12/7 °C and condensing temperature 50 °C. 12) Standard version. 13) S version. 14) Only for handling.





# ECOi-W WSW-N EVO 440-1550 C/H/R - R513A

Water cooled chillers, heat pumps and condenserless units.

Cooling capacity: 410 to 1460 kW.

Heating capacity: 470 to 1650 kW.



## Operating limits

To be confirmed with AC SELECT:  
<https://acselect.panasonic.eu/>

ECOi-W WSW-N EVO 440-1550 C - chiller				
Evaporator	Leaving water temperature	Water	°C	From 5 to 15
		Water + glycol	°C	From 0 to 5
		Brine	°C	From -8 to 0
		ΔT	K	From 3 to 7
Condenser	Leaving water temperature	°C	From 25 to 45	
ECOi-W WSW-N EVO 440-1550 H - heat pump				
Evaporator	Leaving water temperature	Water	°C	From 5 to 15
		Water + glycol	°C	From -8 to 5
		ΔT	K	From 3 to 7
Condenser	Leaving water temperature	°C	From 25 to 60	
ECOi-W WSW-N EVO 440-1550 R - condenserless unit				
Evaporator	Leaving water temperature	Water	°C	From 5 to 15
		Water + glycol	°C	From -8 to 5
		ΔT	K	From 3 to 7
Condenser	Condensing temperature	°C	From 30 to 63	

### Accessories supplied loose

<b>P-376463</b>	Sequencer for up to 4 chillers installation
<b>P-347941</b>	Remote ON / OFF control
<b>P-364735</b>	Remote keyboard panel
<b>P-365581</b>	Flow switch

## The range at a glance

- 3 versions: C (chiller), H (heat pump) and R (condenserless unit)
- 15 sizes
- 2 acoustic options: STD (standard) and S (super low noise)

## Advantages

- High full load performances: EER up to 4,90
- High seasonal performances: SEER up to 6,70
- Compressor optimization (high / low pressure ratio), according application: Maximum benefit in terms of efficiency design
- Electronic expansion device: excellent control of superheating for the best performance at full and partial load and for a safe operation
- New generation of pure counter-current shell and tube evaporators and condensers: maximum efficiency and new levels of competitiveness
- Control platform: modular architecture, compressor envelope integration, corrective actions in border line areas, easy-friendly user interface

## Equipment

- 1 or 2 refrigerant circuit(s)
- Twin-screw compressors
- Shell and tube evaporator and condenser
- Electronic expansion valve
- Compressor acoustic box (standard for S version)
- Phase sequence control

### Accessories and options

Automatic circuit breaker
Compressor stepless control
Mechanical gauges
Power factor corrector capacitors
Several communication protocols
Soft starter

### Accessories supplied loose

<b>P-348620</b>	Water filter for sizes 440-490
<b>P-348618</b>	Water filter for sizes 570-770
<b>P-362589</b>	Water filter for sizes 860-1550

## AC SELECT.

Smart and user-friendly selection tool. Configure your air conditioning solution at required conditions:  
<https://acselect.panasonic.eu/>





Technical performance

Power supply	Voltage	V							400			
	Phase	Three phase							50			
	Frequency	Hz							50			
Size		440	490	570	630	700	770					
<b>ECOi-W WSW-N EVO 440-770 C - chiller</b>		<b>P-WSWVN0440CA</b>	<b>P-WSWVN0490CA</b>	<b>P-WSWVN0570CA</b>	<b>P-WSWVN0630CA</b>	<b>P-WSWVN0700CA</b>	<b>P-WSWVN0770CA</b>					
Cooling capacity <sup>1)</sup>	kW	418,6	471,6	539,3	601,9	664,4	734,6					
Input power <sup>1)</sup>	kW	88,1	101,1	115,1	127,5	144	158,7					
Total heat rejection <sup>1)</sup>	kW	506,7	572,7	654,3	729,4	808,4	893,4					
EER <sup>1)</sup>		4,75	4,67	4,69	4,72	4,61	4,63					
<b>SEER <sup>2)</sup></b>		<b>6,38</b>	<b>6,38</b>	<b>6,52</b>	<b>6,42</b>	<b>6,38</b>	<b>6,38</b>					
$\eta_{s,c}$ <sup>2)</sup>		<b>252</b>	<b>252</b>	<b>258</b>	<b>254</b>	<b>252</b>	<b>252</b>					
Sound power STD / S <sup>3)</sup>	dB(A)	95 / 85	95 / 85	95 / 85	95 / 85	95 / 85	95 / 85					
Sound pressure at 1 m STD / S <sup>4)</sup>	dB(A)	76 / 66	76 / 66	76 / 66	76 / 66	76 / 66	76 / 66					
Size		860	920	990	1070	1130	1220	1280	1400	1550		
<b>ECOi-W WSW-N EVO 860-1550 C - chiller</b>		<b>P-WSWVN0860CA</b>	<b>WSWVN0920CA</b>	<b>WSWVN0990CA</b>	<b>WSWVN1070CA</b>	<b>WSWVN1130CA</b>	<b>WSWVN1220CA</b>	<b>WSWVN1280CA</b>	<b>WSWVN1400CA</b>	<b>WSWVN1550CA</b>		
Cooling capacity <sup>1)</sup>	kW	825	874,1	936,6	1019,1	1071,8	1159,3	1226,1	1334,6	1457,9		
Input power <sup>1)</sup>	kW	177,2	190,3	201,4	215,7	228,1	243,8	257,9	286,3	319		
Total heat rejection <sup>1)</sup>	kW	1002,2	1064,3	1137,9	1234,7	1299,8	1403,0	1484,0	1620,9	1776,9		
EER <sup>1)</sup>		4,66	4,59	4,65	4,73	4,70	4,76	4,75	4,66	4,57		
<b>SEER <sup>2)</sup></b>		<b>6,41</b>	<b>6,41</b>	<b>6,41</b>	<b>6,42</b>	<b>6,53</b>	<b>6,51</b>	<b>6,44</b>	<b>6,45</b>	<b>6,42</b>		
$\eta_{s,c}$ <sup>2)</sup>		<b>254</b>	<b>253</b>	<b>254</b>	<b>254</b>	<b>258</b>	<b>257</b>	<b>254</b>	<b>255</b>	<b>254</b>		
Sound power STD / S <sup>3)</sup>	dB(A)	98 / 89	98 / 89	98 / 89	98 / 89	98 / 89	98 / 89	98 / 89	98 / 89	98 / 89		
Sound pressure at 1 m STD / S <sup>4)</sup>	dB(A)	79 / 70	79 / 70	79 / 70	79 / 70	79 / 70	79 / 70	79 / 70	79 / 70	79 / 70		
<b>ECOi-W WSW-N EVO 440-770 H - heat pump</b>		<b>P-WSWVN0440HA</b>	<b>P-WSWVN0490HA</b>	<b>P-WSWVN0570HA</b>	<b>P-WSWVN0630HA</b>	<b>P-WSWVN0700HA</b>	<b>P-WSWVN0770HA</b>					
Cooling capacity <sup>1)</sup>	kW	419	479	547	612	673	731					
Input power <sup>1)</sup>	kW	86,5	98	115	132	147	156					
EER <sup>1)</sup>		4,85	4,89	4,75	4,64	4,58	4,69					
Cooling capacity <sup>5)</sup>	kW	365,9	418,9	483,2	541	595,6	646,6					
Input power <sup>5)</sup>	kW	105,2	118,8	141,3	162,1	171,2	191,3					
EER <sup>5)</sup>		3,48	3,53	3,42	3,34	3,48	3,38					
<b>SEER <sup>2)</sup></b>		<b>6,53</b>	<b>6,38</b>	<b>6,4</b>	<b>6,38</b>	<b>6,45</b>	<b>6,6</b>					
$\eta_{s,c}$ <sup>2)</sup>		<b>258</b>	<b>252</b>	<b>253</b>	<b>252</b>	<b>255</b>	<b>261</b>					
Heating capacity <sup>1)</sup>	kW	504	576	661	742	813	887					
COP <sup>1)</sup>		5,83	5,88	5,74	5,62	5,53	5,68					
Heating capacity <sup>5)</sup>	kW	470,3	536,5	621,7	698,6	764,7	835,9					
COP <sup>5)</sup>		4,46	4,52	4,4	4,31	4,47	4,37					
Sound power STD / S <sup>3)</sup>	dB(A)	95 / 85	95 / 85	95 / 85	95 / 85	95 / 85	95 / 85					
Sound pressure at 1 m STD / S <sup>4)</sup>	dB(A)	76 / 66	76 / 66	76 / 66	76 / 66	76 / 66	76 / 66					
<b>ECOi-W WSW-N EVO 860-1550 H - heat pump</b>		<b>P-WSWVN0860HA</b>	<b>WSWVN0920HA</b>	<b>WSWVN0990HA</b>	<b>WSWVN1070HA</b>	<b>WSWVN1130HA</b>	<b>WSWVN1220HA</b>	<b>WSWVN1280HA</b>	<b>WSWVN1400HA</b>	<b>WSWVN1550HA</b>		
Cooling capacity <sup>1)</sup>	kW	818	882	946	1013	1083	1156	1217	1340	1451		
Input power <sup>1)</sup>	kW	170	183	195	211	227	242	257	297	306		
EER <sup>1)</sup>		4,81	4,83	4,85	4,80	4,78	4,78	4,74	4,52	4,74		
Cooling capacity <sup>5)</sup>	kW	715,5	772	828,1	891,5	958,8	1023,8	1078,2	1186,9	1285,5		
Input power <sup>5)</sup>	kW	210,1	223,4	236,7	257,3	277	298,6	317,4	342,7	377,4		
EER <sup>5)</sup>		3,41	3,46	3,5	3,46	3,46	3,43	3,4	3,46	3,41		
<b>SEER <sup>2)</sup></b>		<b>6,4</b>	<b>6,5</b>	<b>6,4</b>	<b>6,4</b>	<b>6,5</b>	<b>6,48</b>	<b>6,48</b>	<b>6,5</b>	<b>6,7</b>		
$\eta_{s,c}$ <sup>2)</sup>		<b>253</b>	<b>257</b>	<b>253</b>	<b>253</b>	<b>257</b>	<b>256</b>	<b>256</b>	<b>257</b>	<b>265</b>		
Heating capacity <sup>1)</sup>	kW	987	1064	1141	1222	1308	1396	1470	1619	1754		
COP <sup>1)</sup>		5,8	5,83	5,85	5,8	5,77	5,77	5,73	5,46	5,73		
Heating capacity <sup>5)</sup>	kW	923	992,7	1063	1146	1231,8	1315,8	1386,1	1523,8	1654,6		
COP <sup>5)</sup>		4,39	4,44	4,49	4,45	4,45	4,41	4,37	4,45	4,38		
Sound power STD / S <sup>3)</sup>	dB(A)	98 / 89	98 / 89	98 / 89	98 / 89	98 / 89	98 / 89	98 / 89	98 / 89	98 / 89		
Sound pressure at 1 m STD / S <sup>4)</sup>	dB(A)	79 / 70	79 / 70	79 / 70	79 / 70	79 / 70	79 / 70	79 / 70	79 / 70	79 / 70		
<b>ECOi-W WSW-N EVO 440-770 R - condenserless unit</b>		<b>P-WSWVN0440RA</b>	<b>P-WSWVN0490RA</b>	<b>P-WSWVN0570RA</b>	<b>P-WSWVN0630RA</b>	<b>P-WSWVN0700RA</b>	<b>P-WSWVN0770RA</b>					
Cooling capacity <sup>6)</sup>	kW	358,6	405,3	472,7	535,6	586,2	638,1					
Input power <sup>6)</sup>	kW	106,9	120,2	143,4	161,4	174,9	192,6					
Total heat rejection <sup>6)</sup>	kW	465,8	525,8	614,6	694	760,9	828,8					
Sound power STD / S <sup>3)</sup>	dB(A)	95 / 85	95 / 85	95 / 85	95 / 85	95 / 85	95 / 85					
Sound pressure at 1 m STD / S <sup>4)</sup>	dB(A)	76 / 66	76 / 66	76 / 66	76 / 66	76 / 66	76 / 66					
<b>ECOi-W WSW-N EVO 860-1550 R - condenserless unit</b>		<b>P-WSWVN0860RA</b>	<b>WSWVN0920RA</b>	<b>WSWVN0990RA</b>	<b>WSWVN1070RA</b>	<b>WSWVN1130RA</b>	<b>WSWVN1220RA</b>	<b>WSWVN1280RA</b>	<b>WSWVN1400RA</b>	<b>WSWVN1550RA</b>		
Cooling capacity <sup>6)</sup>	kW	708,9	758,1	817,2	886,2	947,7	1015,0	1075,9	1181,4	1277,8		
Input power <sup>6)</sup>	kW	213,7	226,9	240,7	263,1	284	306,3	325,4	348,4	384,4		
Total heat rejection <sup>6)</sup>	kW	922,3	984,7	1057,4	1147,9	1230,6	1316,3	1395,1	1527,5	1657,7		
Sound power STD / S <sup>3)</sup>	dB(A)	98 / 89	98 / 89	98 / 89	98 / 89	98 / 89	98 / 89	98 / 89	98 / 89	98 / 89		
Sound pressure at 1 m STD / S <sup>4)</sup>	dB(A)	79 / 70	79 / 70	79 / 70	79 / 70	79 / 70	79 / 70	79 / 70	79 / 70	79 / 70		

1) According to EN 14511 standard: evaporator EWT/LWT 12 °C/7 °C, condenser EWT/LWT 30 °C/35 °C. 2) ErP compliant: following COMMISSION REGULATION (EU) 2016/2281 and according to EN 14825 standard. 3) Sound levels are at fully loaded conditions. Sound power values refers to ISO 3744 standard. 4) Sound pressures refer to ISO 3744 standard, parallelepiped shape. 5) According to EN 14511 standard: evaporator EWT/LWT 10 °C/7 °C, condenser EWT/LWT 40 °C/45 °C. 6) Conditions: evaporator EWT/LWT 12 °C/7 °C, condensing Temperature 49 °C.





## Physical features

ECOi-W WSW-N EVO 440-770 C - chiller			440	490	570	630	700	770			
Dimension	Height	mm	1650	1650	1650	1650	1650	1650			
	Height S	mm	1750	1750	1750	1750	1750	1750			
	Width	mm	1350	1350	1350	1350	1350	1350			
	Length	mm	4250	4250	4210	4210	4180	4180			
Operating weight	STD	kg	2690	2700	2875	3003	3472	3521			
	S	kg	2884	2894	3069	3197	3666	3715			
<b>Water connections</b>											
Connection type	Evaporator		Victaulic®	Victaulic®	Victaulic®	Victaulic®	Victaulic®	Victaulic®	Victaulic®	Victaulic®	
Inlet/outlet diameter		Inch	6	6	6	6	8	8	8	8	
Connection type	Condenser		Female gas threaded	Female gas threaded	Female gas threaded	Female gas threaded	Female gas threaded	Female gas threaded	Female gas threaded	Female gas threaded	
Inlet/outlet diameter		Inch	4	4	5	5	5	5	5	5	
<b>ECOi-W WSW-N EVO 860-1550 C - chiller</b>											
			860	920	990	1070	1130	1220	1280	1400	1550
Dimension	Height	mm	1710	1710	1710	1710	1710	1710	1710	1710	1710
	Height S	mm	1780	1780	1780	1780	1780	1780	1780	1780	1780
	Width	mm	1520	1520	1520	1520	1520	1520	1520	1520	1520
	Length	mm	4510	4510	4600	4650	4650	4650	4650	5350	5350
	Length S	mm	4510	4510	4690	4690	4690	4690	4690	5400	5400
Operating weight	STD	kg	5000	5010	5642	5818	6012	6077	6124	6698	6752
	S	kg	5388	5398	6030	6206	6400	6465	6512	7086	7140
<b>Water connections</b>											
Connection type	Evaporator		Victaulic®	Victaulic®	Victaulic®	Victaulic®	Victaulic®	Victaulic®	Victaulic®	Victaulic®	
Inlet/outlet diameter		Inch	8	8	10	10	10	10	10	10	
Connection type	Condenser		Victaulic®	Victaulic®	Victaulic®	Victaulic®	Victaulic®	Victaulic®	Victaulic®	Victaulic®	
Inlet/outlet diameter	Condenser	Inch	4 / 4	4 / 4	5 / 5	5 / 5	5 / 5	5 / 5	5 / 5	5 / 5	
<b>ECOi-W WSW-N EVO 440-770 H - heat pump</b>											
			440	490	570	630	700	770			
Dimension	Height	mm	1650	1650	1650	1650	1650	1650			
	Height S	mm	1750	1750	1750	1750	1750	1750			
	Width	mm	1450	1450	1450	1450	1450	1450			
	Length	mm	4590	4590	4630	4630	4320	4560			
Operating weight	STD	kg	3055	3186	3277	3197	4027	3824			
	S	kg	3249	3380	3471	3491	4221	4017			
<b>Water connections</b>											
Connection type	Evaporator		Victaulic®	Victaulic®	Victaulic®	Victaulic®	Victaulic®	Victaulic®	Victaulic®	Victaulic®	
Inlet/outlet diameter		Inch	6	6	6	6	8	8	8	8	
Connection type	Condenser		Victaulic®	Victaulic®	Victaulic®	Victaulic®	Victaulic®	Victaulic®	Victaulic®	Victaulic®	
Inlet/outlet diameter		Inch	4	4	5	5	5	5	5	5	
<b>ECOi-W WSW-N EVO 860-1550 H - heat pump</b>											
			860	920	990	1070	1130	1220	1280	1400	1550
Dimension	Height	mm	1680	1680	1680	1680	1680	1680	1680	1710	1710
	Height S	mm	1780	1780	1780	1780	1780	1780	1780	1780	1780
	Width	mm	1520	1520	1520	1520	1520	1520	1520	1580	1580
	Length	mm	5110	5110	5100	5100	5000	5000	5000	5300	5300
	Length S	mm	5130	5130	5120	5120	5020	5020	5020	5320	5320
Operating weight	STD	kg	5818	5841	6119	6545	6768	6807	6844	7991	8071
	S	kg	6205	6229	6506	6932	7155	7194	7232	8378	8458
<b>Water connections</b>											
Connection type	Evaporator		Victaulic®	Victaulic®	Victaulic®	Victaulic®	Victaulic®	Victaulic®	Victaulic®	Victaulic®	
Inlet/outlet diameter		Inch	8	8	10	10	10	10	10	10	
Connection type	Condenser		Victaulic®	Victaulic®	Victaulic®	Victaulic®	Victaulic®	Victaulic®	Victaulic®	Victaulic®	
Inlet/outlet diameter		Inch	4 / 4	4 / 4	4 / 4	4 / 5	5 / 5	5 / 5	5 / 5	5 / 5	





## Physical features

<b>ECOi-W WSW-N EVO 440-770 R - condenserless unit</b>			<b>440</b>	<b>490</b>	<b>570</b>	<b>630</b>	<b>700</b>	<b>770</b>			
Dimension	Height	mm	1650	1650	1650	1650	1650	1650			
	Height S	mm	1750	1750	1750	1750	1750	1750			
	Width	mm	1350	1350	1350	1350	1350	1350			
	Length	mm	3620	3620	4210	4210	4180	4180			
Operating weight	STD	kg	2302	2312	2456	2476	2952	2992			
	S	kg	2496	2506	2650	2670	3146	3186			
<b>Water connections (evaporator)</b>											
Connection type			Victaulic®	Victaulic®	Victaulic®	Victaulic®	Victaulic®	Victaulic®			
Inlet/outlet diameter			Inch	6	6	6	6	8	8		
<b>Remote condenser refrigerant connections</b>											
Connection type			To be brazed	To be brazed	To be brazed	To be brazed	To be brazed	To be brazed			
Inlet diameter circuit 1			Inch	1 5/8	1 5/8	2 1/8	2 1/8	2 1/8	2 1/8		
Outlet diameter circuit 1			Inch	3 1/8	3 1/8	3 5/8	3 5/8	4 1/8	4 1/8		
<b>ECOi-W WSW-N EVO 860-1550 R - condenserless unit</b>			<b>860</b>	<b>920</b>	<b>990</b>	<b>1070</b>	<b>1130</b>	<b>1220</b>	<b>1280</b>	<b>1400</b>	<b>1550</b>
Dimension	Height	mm	1710	1710	1710	1710	1710	1710	1710	1710	
	Height S	mm	1770	1770	1770	1770	1770	1770	1770	1770	
	Width	mm	1520	1520	1520	1520	1520	1520	1520	1520	
	Length	mm	4400	4400	4600	4650	4650	4650	4650	5350	5350
	Length S	mm	4650	4650	4650	4650	4650	4650	4650	5400	5400
Operating weight	STD	kg	4804	4814	4998	5071	5131	5170	5190	5596	5676
	S	kg	5191	5201	5385	5458	5518	5557	5577	5983	6063
<b>Water connections (evaporator)</b>											
Connection type			Victaulic®	Victaulic®	Victaulic®	Victaulic®	Victaulic®	Victaulic®	Victaulic®	Victaulic®	
Inlet/outlet diameter			Inch	8	8	10	10	10	10	10	10
<b>Remote condenser refrigerant connections</b>											
Connection type			To be brazed	To be brazed	To be brazed	To be brazed	To be brazed	To be brazed	To be brazed	To be brazed	
Inlet diameter circuit 1			Inch	1 5/8	1 5/8	1 5/8	2 1/8	2 1/8	2 1/8	2 1/8	2 1/8
Outlet diameter circuit 1			Inch	3 1/8	3 1/8	3 1/8	3 1/8	3 1/8	3 1/8	4 1/8	4 1/8
Inlet diameter circuit 2			Inch	1 5/8	1 5/8	1 5/8	2 1/8	2 1/8	2 1/8	2 1/8	2 1/8
Outlet diameter circuit 2			Inch	3 1/8	3 1/8	3 1/8	3 1/8	3 1/8	3 1/8	4 1/8	4 1/8

## Water source heat pumps

One building, different needs!

ECOi-LOOP water source heat pumps are ideal for best in class hotels, offices or shopping centers. This solution offers improved comfort by having several different indoor climates inside a building, while maintaining the energy through an internal closed water loop.



## What is a water loop system with water source heat pumps?

**The water loop system enables distributed cooling and heating production at different temperatures with a single water circuit.**

The recovery of condensation heat units in cooling can be used for units in heating and vice-versa, thus providing a balanced and highly efficient system. These indoor units are called water source heat pumps which are equipped with a compressor and 2 heat exchangers to allow energy transfer between the water loop and air within the space.



## Environmentally friendly and economic

\* Model shown: ECOi-LOOP-N EVO.

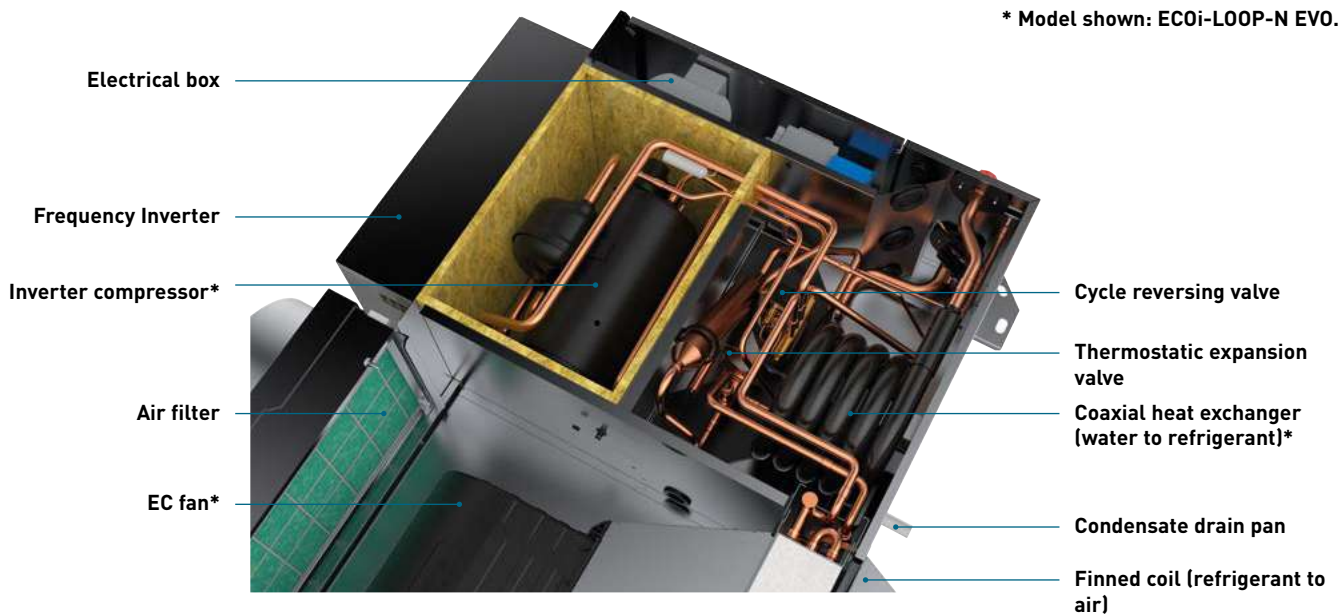











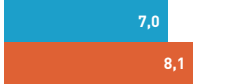

## Key features for ECOi-LOOP.

- High efficiency
- Heating and cooling of rooms at the same time. All units are connected to the same water loop
- Decentralised cool/heat production (closed water circuit)
- Water heater or cooling tower do not need to be operated as long as cooling and heating loads are roughly balanced. Temperature in the water loop will be kept between 16 and 32 °C
- Reduced refrigerant charge (no refrigerant pipes to an outdoor unit required)
- Low risk of leakage (hermetically sealed systems)
- Water source heat pumps can be easily added or removed without changing the system layout
- Each unit is autonomous and has its own controller allowing also its own safety



# Quick selection guide - Water source heat pumps

Page	Size	Cooling and heating capacity (kW)	NR sound levels (at MS)	Nominal air flow <sup>1)</sup> (m <sup>3</sup> /h)	Pressure (Pa)	Fan	Dimension LxWxH (mm)	
P. 534		15		26	435	0-140	EC	900 x 530 x 250 <sup>2)</sup>
		20		30	465	0-140	EC	900 x 530 x 250 <sup>2)</sup>
		30		34	525	0-140	EC	900 x 530 x 250 <sup>2)</sup>
P. 536		70		52	1727	0-495	EC	1142 x 762 x 516 <sup>2)</sup>
		85		50	2165	0-495	EC	1142 x 762 x 516 <sup>2)</sup>
		100		56	2826	0-335	EC	1333 x 818 x 580 <sup>2)</sup>
		110		54	3078	0-250	EC	1333 x 818 x 580 <sup>2)</sup>
		120		55	3309	0-350	EC	1333 x 818 x 580 <sup>2)</sup>
		135		57	3677	0-260	EC	1333 x 818 x 580 <sup>2)</sup>
P. 538			25,8 <sup>3)</sup>	525	0-140	EC	900 x 636 x 250 <sup>2)</sup>	

1) At high speed. 2) Without air inlet/outlet options. 3) At minimum thermal load.



Page	Size	Cooling and heating capacity (kW)	NR sound levels (at MS)	Nominal air flow <sup>1)</sup> (m <sup>3</sup> /h)	Pressure (Pa)	Fan	Dimension LxWxH (mm)			
<b>P. 540</b>		ECOi-LOOP HRW H · R407C		19	5,3 5,8	37	1250	>50	AC	900 x 600 x 439
		ECOi-LOOP HRWE H · R407C		27	7,4 8,3	34	1190	>50	AC	1050 x 600 x 460
		27 HE	7,5 9,3	34	1180	>50	AC	1050 x 660 x 460		
		30	8,7 9,8	35	1490	>100	AC	1050 x 660 x 460		
		30 HE	8,9 10,0	35	1500	>100	AC	1050 x 660 x 460		
		36	10,1 11,0	37	1580	>100	AC	1050 x 660 x 460		
		36 HE	11,1 12,2	37	1580	>100	AC	1250 x 705 x 513		
		42	11,4 14,4	40	2040	>100	AC	1250 x 705 x 513		
		42 HE	12,5 14,5	40	2040	>100	AC	1250 x 705 x 513		
		48	13,0 14,9	43	2750	>100	AC	1250 x 705 x 513		
		60	14,3 16,1	43	2840	>100	AC	1250 x 705 x 513		
		60 HE	16,7 18,8	43	2840	>100	AC	1250 x 705 x 583		
		72	17,1 21,5	39	3570	>100	AC	1250 x 705 x 513		
		72 HE	20,6 22,6	39	3800	>100	AC	1680 x 955 x 770		
		96	21,7 26,6	54	4700	>100	AC	1680 x 955 x 770		
		96 HE	24,5 28,5	54	4700	>100	AC	1680 x 955 x 770		
120	30,0 38,1	53	5600	>200	AC	1680 x 955 x 770				

**ECOi-LOOP FS H · R407C**



**P. 542**

12	2,7 3,2	40	510	0	AC/EC	1138 x 251 x 821 <sup>2)</sup>
----	------------	----	-----	---	-------	--------------------------------

**ECOi-LOOP-N FS H · R513A**



**P. 544**

7	1,7 1,8	34	340	0	AC/EC	1138 x 260 x 821 <sup>2)</sup>
9	2,0 2,6	36	400	0	AC/EC	1138 x 260 x 821 <sup>2)</sup>

1) At high speed. 2) Standard unit with cabinet and feet.



# ECOi-LOOP 15-30 C/H · R410A

Water source heat pumps cooling only and reversible.

Cooling capacity: 1,5 to 2,9 kW.

Heating capacity: 1,9 to 3,7 kW.



Optional controller.  
RCS remote control.



Optional controller.  
SRC - mini BMS controller.

+ SEE PAGE 546 FOR MORE DETAILS ABOUT WATER SOURCE HEAT PUMPS CONTROL SYSTEMS

## Operating limits

Air inlet temperature.

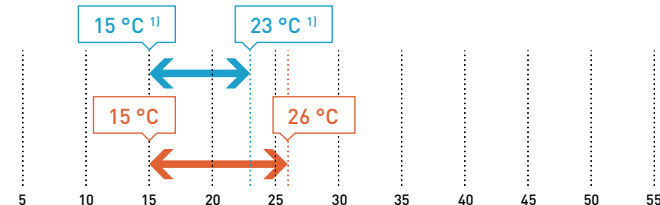

Water inlet temperature.

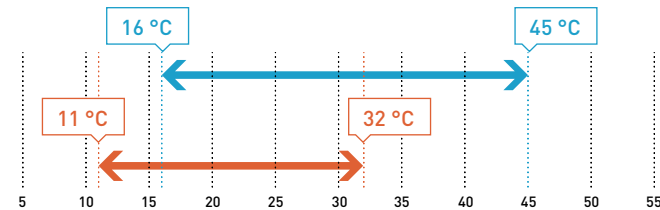

1) From 21 to 32 °C DB. \* Maximum water pressure 10 bars.

## The range at a glance

- 2 versions: C (cooling only) and H (reversible)
- 3 sizes
- Horizontal installation
- Nominal air flow from 435 to 525 m<sup>3</sup>/h
- Many air and water configurations available
- 140 Pa maximum external static pressure
- Operating range: from 15 °C to 32 °C ambient air temperature
- Water inlet temperature from 11 °C to 45 °C

## Advantages

- Very high performances: EER up to 5,05 and COP up to 5,70
- Low energy consumption EC fan
- In-line or perpendicular air flow
- Increased robustness: coaxial heat exchanger
- Easy access to the internal components: large electrical panel and filter accessible from 3 sides
- 100% factory tested

## Equipment

- The refrigerant circuit comprises a rotary type hermetic compressor, a cycle reversal valve (H type only), a water/refrigerant heat exchanger, a liquid receiver, a capillary expansion device, a finned coil, HP and LP pressure switches and 2 Schrader valves (HP and LP)
- The rotary type hermetic compressor, mounted on spring anti-vibration mounts, is integrated in a compartment coated with reinforced acoustic insulation. It is also equipped with internal thermal protection
- The water/refrigerant heat exchanger is of copper/stainless steel coaxial type for an increased efficiency
- The units are equipped with a control system (POL423) utilising Modbus RTU
- The casing is made of galvanised steel sheet
- Condensate drain pan with an anti-corrosion treatment
- The electrical box is located on the hydraulic service side with a wide access panel
- The units are equipped with multi-position brackets for easy installation

## AC SELECT.

Smart and user-friendly selection tool. Configure your air conditioning solution at required conditions:  
<https://acselect.panasonic.eu/>





## Technical features

ECOi-LOOP 15-30 C - cooling only		P-LPE015CA	P-LPE020CA	P-LPE030CA
ECOi-LOOP 15-30 H - reversible		P-LPE015HA	P-LPE020HA	P-LPE030HA
Total cooling capacity <sup>1)</sup>	W	1507	2151	2902
Sensible cooling capacity <sup>1)</sup>	W	1371	1733	2355
EER		4,51	5,05	4,25
Heating capacity <sup>2)</sup>	W	1934	2510	3680
COP		5,49	5,70	4,97
<b>Ventilation</b>				
Number of fans			1	
Nominal air flow	m <sup>3</sup> /h	435	465	525
Motor power	W	24	38	53
Air filter	Number / efficiency	1 / Basic or G3M1	1 / Basic or G3M1	1 / Basic or G3M1
<b>Hydraulic circuit</b>				
Water heat exchanger	Number / type	1 / Coaxial	1 / Coaxial	1 / Coaxial
Maximum water pressure	bar	10	10	10
Nominal water flow	l/h	317	444	617
WPD at nominal water flow	kPa	8	12	18
Connections - inlet/outlet (Ø)	Inch	½ Male gas	½ Male gas	½ Male gas
Condensate outlet - external (Ø)	mm	16	16	16
<b>Refrigerant circuit</b>				
Number of refrigerant circuits		1	1	1
Compressor type		Rotary	Rotary	Rotary
Load	g	415	565	565
<b>Electrical data</b>				
Power supply	Voltage	V	230	230
	Phase		Single phase	Single phase
	Frequency	Hz	50 ±10%	50 ±10%
Input power <sup>3)</sup>	Cooling	W	365	471
	Heating	W	389	491
Electric heating coil <sup>4)</sup>	Number / capacity	- / W	1 / 600+600	1 / 800+800
	Input power	W	1200	1600
<b>Sound levels - without acoustic options</b>				
Sound power - radiated	Lo / Med / Hi	dB(A)	41,9 / 43,1 / 44,4	42,7 / 44,5 / 46,5
Sound power - discharge	Lo / Med / Hi	dB(A)	45,6 / 49,1 / 53	49,1 / 53,6 / 58,3
Sound pressure <sup>5)</sup>	Lo / Med / Hi	dB(A)	27,1 / 30 / 33,5	30 / 34,1 / 38,4
NR <sup>5)</sup>	Lo / Med / Hi		22,4 / 25,7 / 29,4	25,8 / 30,1 / 34,4
<b>Sound levels - with air outlet silencer and insulation around the fan</b>				
Sound power - radiated	Lo / Med / Hi	dB(A)	42,3 / 43,2 / 44,5	42,7 / 44,4 / 46,5
Sound power - discharge	Lo / Med / Hi	dB(A)	32,2 / 35,2 / 38,5	34,7 / 38,5 / 42,5
Sound pressure <sup>5)</sup>	Lo / Med / Hi	dB(A)	23,2 / 25 / 27,3	24,8 / 27,7 / 31
NR <sup>5)</sup>	Lo / Med / Hi		18,8 / 20,4 / 22,7	20,1 / 23 / 26,4
<b>Dimension - without air inlet/outlet options</b>				
Length	mm	900	900	900
Width	mm	530	530	530
Height	mm	250	250	250
<b>Weight - without air inlet/outlet options</b>				
Operating weight	kg	48	48	48

1) Nominal cooling capacities based on entering air temperature of 27 °C DB, 19 °C WB with entering water temperature of 30 °C. 2) Nominal heating capacities based on entering air temperature of 20 °C DB, 15 °C WB with entering water temperature of 20 °C. 3) Input power at nominal conditions (compressor + fan at high speed). 4) Electric heating coil is available as an option. 5) Informative data, considering an hypothetical sound attenuation of the room and installation of 21 dB(A). In-line configuration with filter.

### Accessories and options

Air outlet silencer
Basic or G3M1 filter
Circuit breaker
Modbus RTU protocol-standard. Controller with BACnet MSTP - optional (BACnet IP, LON and Modbus TCP/IP available upon request)
Drain outlet
Drain pump

### Accessories supplied loose

<b>P-393446</b>	RCS kit remote control with thermostat (POL822)
<b>P-375281</b>	SRC - mini BMS controller (only with Modbus RTU)

### Accessories and options

Electric heaters
Flow switch control
Insulation around the fan
Many air inlet/outlet and water connection configurations
Pressostatic valve (cooling only)
Room temperature sensor

### Accessories supplied loose

<b>P-372061</b>	Kit remote keyboard panel
-----------------	---------------------------



**HIGH EER**  
5,85

**HIGH COP**  
5,70





# ECOi-LOOP-N 70-135 H · R513A

Water source heat pumps reversible.

Cooling capacity: 7,0 to 13,3 kW.

Heating capacity: 8,1 to 14,6 kW.



Optional controller.  
RCS remote control.



Optional controller.  
SRC - mini BMS controller.

SEE PAGE 546 FOR MORE DETAILS ABOUT WATER SOURCE HEAT PUMPS CONTROL SYSTEMS

## Operating limits

Air inlet temperature.

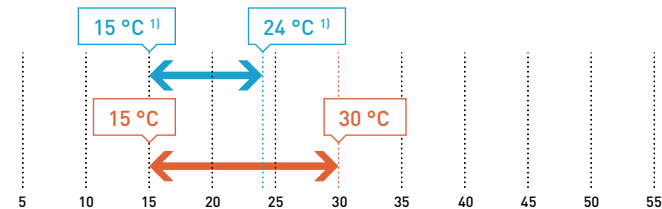

Water inlet temperature.

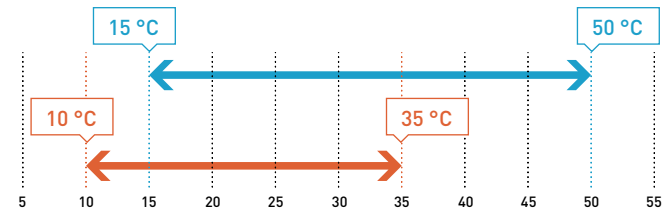

1) From 21 to 33 °C DB. \* Maximum water pressure 10 bars.

## The range at a glance

- 1 version: H (reversible)
- 6 sizes
- Horizontal installation
- Nominal air flow from 1730 to 3680 m<sup>3</sup>/h
- In-line or perpendicular air flow
- Up to 495 Pa according to size
- Operating range: from 15 °C to 32 °C ambient air temperature
- Water inlet temperature from 11 °C to 45 °C

## Advantages

- Very high performances: EER up to 3,95 and COP up to 4,58
- Low energy consumption EC fan
- Increased robustness: coaxial heat exchanger
- Easy access to the internal components: a wide removable panel allows an easy access to the electrical panel and the access to the filter is from the side of the unit, without removing the return duct
- 100% factory tested

## Equipment

- The refrigerant circuit comprises a scroll type hermetic compressor, a cycle reversal valve, a water/refrigerant heat exchanger, a bi-flow thermostatic expansion valve, a finned coil, HP and LP pressure switches and 2 Schrader valves (HP and LP)
- The scroll type hermetic compressor, mounted on spring anti-vibration mounts, is integrated in a compartment coated with reinforced acoustic insulation. It is also equipped with internal thermal protection
- The water/refrigerant heat exchanger is of copper/stainless steel coaxial type for an increased efficiency
- The units are equipped with a control system (POL423) utilising Modbus RTU
- The casing is made of galvanised steel sheet
- Condensate drain pan with an anti-corrosion treatment
- The electrical box is located inside the compressor compartment with a wide access panel

## AC SELECT.

Smart and user-friendly selection tool. Configure your air conditioning solution at required conditions:

<https://acselect.panasonic.eu/>







## Technical features

ECOi-LOOP-N 70-135 H - reversible		P-LPN070HA	P-LPN085HA	P-LPN100HA	P-LPN110HA	P-LPN120HA	P-LPN135HA	
Total cooling capacity <sup>1)</sup>	W	7011	8407	10290	11183	12105	13301	
Sensible cooling capacity <sup>1)</sup>	W	5960	7146	8541	9282	10047	11040	
Total absorbed power <sup>2)</sup>	W	1776	2275	2743	3234	3161	3784	
EER Compressor		4,53	4,21	4,36	4,0	4,46	4,1	
EER according to EN 14511		3,95	3,7	3,75	3,46	3,83	3,52	
Total heating capacity <sup>3)</sup>	W	8069	9808	11307	12514	13834	14639	
Total absorbed power <sup>2)</sup>	W	1761	2256	2590	3073	3081	3467	
COP Compressor		5,27	4,96	5,12	4,75	5,25	5,0	
COP according to EN 14511		4,58	4,35	4,37	4,07	4,49	4,22	
<b>Ventilation</b>								
EC voltage	V	3,80	5,50	7,80	8,80	7,60	8,60	
Air flow	Min (LS)	m <sup>3</sup> /h	1123	1407	1837	2001	2157	2390
	Med (MS)	m <sup>3</sup> /h	1425	1786	2331	2539	2730	3034
	Max (nominal) (HS)	m <sup>3</sup> /h	1727	2165	2826	3078	3309	3677
Nominal static pressure	Pa	100	100	100	100	100	100	
Fan absorbed power	W	328	393	552	631	617	737	
Fan power	W	684	653	703	738	671	722	
Air filter	Number / efficiency	1 / G2M1	1 / G2M1	1 / G2M1	1 / G2M1	1 / G2M1	1 / G2M1	
<b>Hydraulic circuit</b>								
Water heat exchanger	Number / type	1 / Coaxial	1 / Coaxial	1 / Coaxial	1 / Coaxial	1 / Coaxial	1 / Coaxial	
Maximum water pressure	Bar	10	10	10	10	10	10	
Nominal water flow	Cooling <sup>1)</sup>	l/h	1497	1818	2274	2508	2649	2957
	Heating <sup>3)</sup>	l/h	1882	2256	2514	2738	3143	3463
Cutoff water flow	Cooling	l/h	749	909	1137	1254	1325	1479
	Heating	l/h	941	1128	1257	1369	1572	1732
WPD at nominal water flow	Cooling <sup>1)</sup>	kPa	35,9	49,8	39,6	46,6	30,6	38,3
	Heating <sup>3)</sup>	kPa	52,7	71,3	46,8	53,9	43,4	53
Hydraulic connections - inlet/outlet	Inch	1 Male gas	1 Male gas	1 Male gas	1 Male gas	1 Male gas	1 Male gas	
Condensate outlet (Ø)	mm	19	19	19	19	19	19	
<b>Refrigerant circuit</b>								
Number of refrigerant circuits		1	1	1	1	1	1	
Compressor type		Scroll	Scroll	Scroll	Scroll	Scroll	Scroll	
Load	g	1040	1165	1108	1116	1355	1363	
<b>Electrical data</b>								
Power supply	Voltage	V	400	400	400	400	400	
	Phase		Three phase	Three phase	Three phase	Three phase	Three phase	
	Frequency	Hz	50	50	50	50	50	
Maximum current without heating	A	12,8	13,4	15,6	18,2	17,3	18,1	
Starting current	A	53,5	53,5	53,5	78,5	71,4	78,4	
<b>Sound levels</b>								
Sound power Lw - radiated	Lo / Med / Hi	dB(A)	60,6/65/65,4	59,5/65,3/66,1	61/66,9/69,4	62,1/67,7/10,4	58/62,6/67,4	58,8/63,9/68,8
Sound power Lw - discharge	Lo / Med / Hi	dB(A)	53,8/62,9/71	62,8/69,5/73,6	68,4/72,7/77,1	68,8/72,6/77,2	64,5/69,3/73,5	65,7/71,2/75,6
Sound power Lw	Lo / Med / Hi	dB(A)	63,7/68,1/72,6	65,5/71,4/74,7	69,6/74,1/78,1	70,1/74,3/78,5	66,5/70,9/75,1	67,5/72,7/77
Sound pressure Lp <sup>4)</sup>	Lo / Med / Hi	dB(A)	49/54,3/56,2	49,5/54,3/56,4	55,3/58,8/62,6	54,4/57,6/61,9	52,5/56,8/60,5	52,7/58,5/62,1
NR <sup>4)</sup>	Lo / Med / Hi		45,9/51,5/51,2	45,9/49,9/50,9	52,3/55,5/58,5	52,3/54,4/59,1	50,7/55,2/58,4	50,7/56,9/60,3
<b>Dimension - without air inlet/outlet options</b>								
Length	mm	1142	1142	1333	1333	1333	1333	
Width	mm	762	762	818	818	818	818	
Height	mm	516	516	580	580	580	580	
<b>Weight</b>								
Operating weight	kg	134	134	153	153	160	160	

1) Nominal cooling capacities based on entering air temperature of 27 °C DB, 19 °C WB with entering water temperature of 30 °C. 2) Input power at nominal conditions (compressor + fan at high speed).

3) Nominal heating capacities based on entering air temperature of 20 °C DB, 15 °C WB with entering water temperature of 20 °C. 4) Informative data, considering an hypothetical sound attenuation of the room and installation of 21 dB(A). In-line configuration with filter.

### Accessories and options

G2M1 filter or G3 filter

Circuit breaker

Modbus RTU protocol-standard. Controller with BACnet MSTP - optional (BACnet IP, LON and Modbus TCP/IP available upon request)

Drain pump

### Accessories supplied loose

**P-393446** RCS kit remote control with thermostat (POL822)

**P-375281** SRC - mini BMS controller (only with Modbus RTU)

### Accessories and options

Electric heaters

Flow switch control

General default report

Many air configurations

Room temperature sensor

### Accessories supplied loose

**P-372061** Kit remote keyboard panel



HIGH  
EER  
3,95

HIGH  
COP  
4,58





# ECOi-LOOP-N EVO C/H · R513A

Water source heat pumps cooling only and reversible.

Cooling capacity: 1,7 to 2,9 kW.

Heating capacity: 2,0 to 3,8 kW.



Optional controller.  
RCS remote control.



Optional controller.  
SRC - mini BMS controller.



SEE PAGE 546 FOR MORE DETAILS ABOUT WATER SOURCE HEAT PUMPS CONTROL SYSTEMS

## Operating limits

Air inlet temperature.

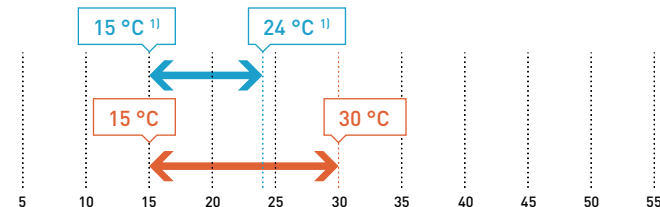

Water inlet temperature.

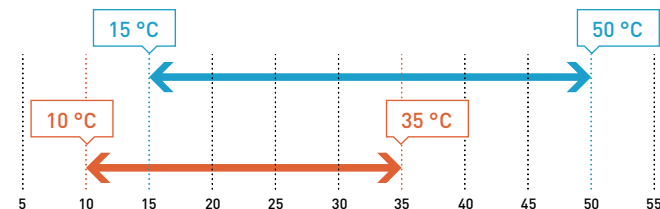

1) From 21 to 33 °C DB. \* Maximum water pressure 10 bars.

## The range at a glance

- Unique size available in C (cooling only) or H (reversible) versions
- Horizontal installation
- Air flow from 290 to 525 m<sup>3</sup>/h
- Inverter compressor technology
- Many air and water configurations available
- 140 Pa maximum external static pressure
- Operating range: from 15 °C to 32 °C ambient air temperature
- Water inlet temperature from 11 °C to 45 °C

## Advantages

- Eco-friendly: R513A refrigerant with very low GWP (631) and low energy consumption EC fan
- Economic: Inverter compressor adapting its speed according to the required capacity
- Extra silent unit: NR<26 at low speed and reinforced insulation
- Very high-performance: EER up to 4,25 and COP up to 4,53
- Low height for an easy integration: only 250 mm
- Highly customisable: many aerualic configurations and selection of the hydraulic service side
- Increased robustness: coaxial heat exchanger
- Easy access to the internal components: large electrical panel and filter accessible from 3 sides
- 100% factory tested

## Equipment

- The refrigerant circuit comprises an Inverter rotary type hermetic compressor, a cycle reversal valve (for H type), a water/refrigerant heat exchanger, a liquid receiver, a thermostatic expansion valve, a finned coil, HP and LP pressure switches and 2 Schrader valves (HP and LP)
- The Inverter rotary type hermetic compressor, mounted on spring anti-vibration mounts, is integrated in a compartment coated with reinforced acoustic insulation. It is also equipped with internal thermal protection
- The water/refrigerant heat exchanger is of copper/stainless steel coaxial type for an increased efficiency
- The unit is equipped with a complete control system (Modbus RTU or BACnet MSTP protocol communication)
- The casing is made of galvanised steel sheet
- Condensate drain pan with an anti-corrosion treatment
- The electrical box is located on the hydraulic service side with a wide access panel
- The units are equipped with multi-position brackets for easy installation



## Technical features

ECOi-LOOP-N EVO C - cooling only			P-LPVN030CA
ECOi-LOOP-N EVO H - reversible			P-LPVN030HA
Total cooling capacity <sup>1)</sup>	Min - Max <sup>2)</sup>	W	1687 - 2948
Sensible cooling capacity <sup>1)</sup>	Min - Max <sup>2)</sup>	W	1363 - 2337
EER	Min - Max <sup>2)</sup>		4,25 - 3,06
Heating capacity <sup>3)</sup>	Min - Max <sup>2)</sup>	W	2004 - 3769
COP	Min - Max <sup>2)</sup>		4,53 - 3,45
<b>Ventilation</b>			
Number of fans			1
Nominal air flow (at low and high speeds)	Min - Max <sup>2)</sup>	m <sup>3</sup> /h	290 - 525
Motor power (at low and high speeds)	Min - Max <sup>2)</sup>	W	13 - 54
Air filter	Number / efficiency		1 / Basic or G3
<b>Hydraulic circuit</b>			
Water heat exchanger	Number / type		1 / Coaxial
Maximum water pressure		bar	10
Nominal water flow	Cooling Min - Max <sup>2)</sup>	l/h	354 - 662
	Heating Min - Max <sup>2)</sup>	l/h	458 - 789
WPD at nominal water flow <sup>4)</sup>	Cooling Min - Max <sup>2)</sup>	kPa	9 - 19,5
	Heating Min - Max <sup>2)</sup>	kPa	12,3 - 24,6
Connections - inlet/outlet (Ø)		Inch	½ Male gas
Condensate outlet - external (Ø)		mm	16
<b>Refrigerant circuit</b>			
Number of refrigerant circuits			1
Compressor type			Inverter rotary
Load		g	514
<b>Electrical data</b>			
Power supply	Voltage	V	230
	Phase		Single phase
	Frequency	Hz	50 ±10%
Input power <sup>5)</sup>	Cooling Min - Max <sup>2)</sup>	W	397 - 964
	Heating Min - Max <sup>2)</sup>	W	442 - 1093
Electric heating coil <sup>6)</sup>	Number / capacity Min - Max <sup>2)</sup>	- / W	1 / 600 + 600 - 1 / 1000 + 1000
	Input power Min - Max <sup>2)</sup>	W	1200 - 2000
<b>Sound levels - without acoustic options</b>			
Sound power - radiated	Min - Max <sup>2)</sup>	dB(A)	41,9 - 51,5
Sound power - discharge	Min - Max <sup>2)</sup>	dB(A)	47,9 - 62,8
Sound pressure <sup>7)</sup>	Min - Max <sup>2)</sup>	dB(A)	29,3 - 43
NR <sup>7)</sup>	Min - Max <sup>2)</sup>		25,8 - 39,2
<b>Sound levels - with air outlet silencer and insulation around the fan</b>			
Sound power - radiated	Min - Max <sup>2)</sup>	dB(A)	42,3 - 51,6
Sound power - discharge	Min - Max <sup>2)</sup>	dB(A)	33,2 - 44,4
Sound pressure <sup>7)</sup>	Min - Max <sup>2)</sup>	dB(A)	24,5 - 35
NR <sup>7)</sup>	Min - Max <sup>2)</sup>		19,5 - 30,4
<b>Dimension - without air inlet/outlet options</b>			
Length		mm	900
Width		mm	636
Height		mm	250
<b>Weight - without air inlet/outlet options</b>			
Operating weight		kg	51

1) Nominal cooling capacities based on entering air temperature of 27 °C DB, 19 °C WB with entering water temperature of 30 °C. 2) Thermal load. 3) Nominal heating capacities based on entering air temperature of 20 °C DB, 15 °C WB with entering water temperature of 20 °C. 4) Without valve. 5) Input power at nominal conditions (compressor + fan at high speed). 6) Electric heating coil is available as an option. 7) Informative data, considering an hypothetical sound attenuation of the room and installation of 21 dB. In-line configuration with filter.

### Accessories and options

Air outlet silencer
Basic or G3M1 filter
Circuit breaker
Modbus RTU protocol-standard. Controller with BACnet MSTP - optional (BACnet IP, LON and Modbus TCP/IP available upon request)
Drain outlet
Drain pump

### Accessories supplied loose

<b>P-393446</b>	RCS kit remote control with thermostat (POL822)
<b>P-375281</b>	SRC - mini BMS controller (only with Modbus RTU)

### Accessories and options

Electric heaters
Flow switch control
General default report
Insulation around the fan
Many air inlet/outlet and water connection configurations
Room temperature sensor

### Accessories supplied loose

<b>P-372061</b>	Kit remote keyboard panel
-----------------	---------------------------



**HIGH EER**  
4,25

**HIGH COP**  
4,53





# ECOi-LOOP HRW H and ECOi-LOOP HRWE H · R407C

Water source heat pumps reversible.

Cooling capacity: 5,3 to 30,0 kW.

Heating capacity: 5,8 to 38,1 kW.



Optional controller.  
RCS remote control.



Optional controller.  
SRC - mini BMS controller.



SEE PAGE 546 FOR MORE DETAILS ABOUT WATER SOURCE HEAT PUMPS CONTROL SYSTEMS

## Operating limits

Air inlet temperature.

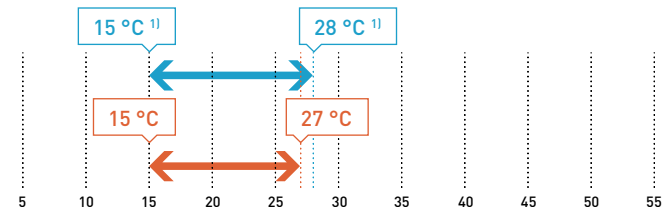

Water inlet temperature.

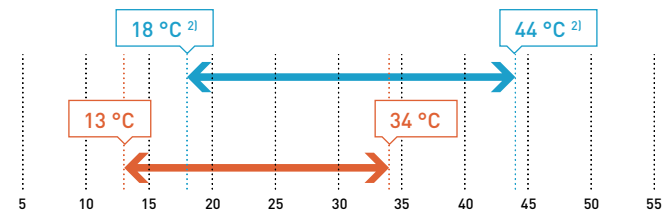

1) From 21 to 38 °C DB. 2) From 20 to 48 °C for 96-120. \* Maximum water pressure 16 bars.

## The range at a glance

- 1 version: H (reversible)
- 10 sizes
- Horizontal installation
- Versions: standard or HE\*\* (very high efficiency)
- Nominal air flow from 1180 to 5600 m<sup>3</sup>/h
- AC fan: 3-speed direct drive fan motor for sizes 19 to 72 and belt drive with variable pitch pulley for sizes 96 and 120
- Operating range: from 15 °C to 38 °C ambient air temperature
- Water inlet temperature from 13°C to 48 °C

## Advantages

- Low sound levels: acoustic insulation between ventilation and compressor compartments
- Very high efficiency versions (HE)\*: EER up to 4,74 and COP up to 4,46
- In-line or perpendicular air flow
- Easy access to components through wide removable panels
- Condensate drain pan with an anti-corrosion treatment and a float-type safety system
- 100% factory tested

## Equipment

- The refrigerant circuit comprises a scroll or rotary type hermetic compressor, a cycle reversal valve (for H type), a water/refrigerant heat exchanger, a liquid receiver, a bi-flow thermostatic expansion valve and a finned coil, HP and LP pressure switches and 2 Schrader valves (HP and LP)
- The rotary or scroll type hermetic compressor, mounted on rubber anti-vibration mounts, is integrated in a compartment coated with reinforced acoustic insulation. It is also equipped with internal thermal protection
- The units are equipped with a control system (POL423) utilising Modbus RTU
- The water/refrigerant heat exchanger is made of brazed stainless steel plates, for improved efficiency
- Condensate drain pan with an anti-corrosion treatment and a float-type safety system
- A G2-M1 air filter is provided within the unit

\* HE versions only available for reversible units.

## AC SELECT.

Smart and user-friendly selection tool. Configure your air conditioning solution at required conditions:

<https://acselect.panasonic.eu/>





Technical features

ECOi-LOOP HRW H - reversible	P-LPHM***HA*** 1)	019	027	—	030	—	036	—	042	—	048	060	—	072	—	096	—	120	
ECOi-LOOP HRWE H - reversible	P-LPHEM***HA*** 1)	—	—	027	—	030	—	036	—	042	—	—	060	—	072	—	096	—	
Total cooling capacity 2)	W	5278	7419	7320	8691	8710	10138	11060	11366	12500	12965	14344	16700	17174	20600	21743	24500	29951	
Sensible cooling capacity 2)	W	4257	5824	5600	6315	6676	7278	9070	8849	9542	10051	10988	13900	13536	17700	17986	19500	24413	
EER		4,20	3,72	4,00	3,77	4,15	3,77	4,31	3,44	4,00	4,03	3,23	4,44	3,26	4,74	3,84	4,61	4,21	
Heating capacity 3)	W	5826	8342	9252	9759	9960	11036	12200	14422	14450	14904	16147	18800	21500	22600	26637	28500	38109	
COP		4,40	3,69	4,21	3,50	4,30	3,38	4,28	3,84	4,36	4,25	3,33	4,20	3,15	4,23	3,54	4,46	4,25	
<b>Ventilation</b>																			
Number of fans		1	1	1	1	1	1	1	1	1	1	1	1	1	1	1	1	1	1
Nominal air flow	m <sup>3</sup> /h	1250	1190	1180	1490	1500	1580	1580	2040	2040	2750	2840	2840	3570	3800	4700	4700	5600	
Motor power	W	450	450	450	950	950	950	950	950	950	1500	1500	1500	1500	736	1100	1100	1500	
Air filter	Number / efficiency	2 / G2-M1	2 / G2-M1	2 / G2-M1	2 / G2-M1	2 / G2-M1	2 / G2-M1	2 / G2-M1	2 / G2-M1	2 / G2-M1	2 / G2-M1	2 / G2-M1	2 / G2-M1	2 / G2-M1	2 / G2-M1	2 / G2-M1	2 / G2-M1	2 / G2-M1	
<b>Hydraulic circuit</b>																			
Number of plate heat exchanger		1	1	1	1	1	1	1	1	1	1	1	1	1	1	1	1	1	
Maximum water pressure	bar	16	16	16	16	16	16	16	16	16	16	16	16	16	16	16	16	16	
Nominal water flow	l/h	921	1540	1620	1764	1800	2030	2306	2592	2600	2822	3348	3550	3924	4300	4860	4960	6408	
WPD at nominal water flow	kPa	13	17	13	23	20	25	21	33	28	34	40	35	61	50	55	55	80,5	
Connections - inlet/outlet (Ø)	Inch	ISO G ¾ INT	ISO G ¾ INT	ISO G ¾ INT	ISO G ¾ INT	ISO G ¾ INT	ISO G ¾ INT	ISO G ¾ INT	ISO G ¾ INT	ISO G ¾ INT	ISO G ¾ INT	ISO G ¾ INT	ISO G ¾ INT	ISO G ¾ INT	ISO G 1 ¼	ISO G ¾ INT	ISO G 1 ¼	ISO G 1 ¼	
Condensate outlet - external (Ø)	mm	19	19	19	19	19	19	19	19	19	19	19	19	19	22	22	22	22	
<b>Refrigerant circuit</b>																			
Number of refrigerant circuits		1	1	1	1	1	1	1	1	1	1	1	1	1	1	1	1	1	
Compressor type		Rotary	Scroll	Scroll	Scroll	Scroll	Scroll	Scroll	Scroll	Scroll	Scroll	Scroll	Scroll	Scroll	Scroll	Scroll	Scroll	Scroll	
Load	g	1160	1483	2534	1594	1950	1950	3200	3200	2800	3200	3200	3400	2700	3800	5100	5100	5100	
<b>Electrical data</b>																			
Power supply	Voltage	V	230	400	400	400	400	400	400	400	400	400	400	400	400	400	400	400	
	Phase		Single phase	Three phase	Three phase	Three phase	Three phase	Three phase	Three phase	Three phase	Three phase	Three phase	Three phase	Three phase	Three phase	Three phase	Three phase	Three phase	
	Frequency	Hz	50 ±10%	50+ Neutral	50+ Neutral	50+ Neutral	50+ Neutral	50+ Neutral	50+ Neutral	50+ Neutral	50+ Neutral	50+ Neutral	50+ Neutral	50+ Neutral	50+ Neutral	50+ Neutral	50+ Neutral	50+ Neutral	
Input power 4)	Cooling	W	1557	2118	1981	2658	2357	3044	2909	3584	3423	4200	4989	4278	6280	5279	6317	5954	
	Heating	W	1611	2332	2382	2983	2475	3460	3203	3920	3479	4300	5150	5098	7347	6188	7895	7115	
Electric heating coil	Number / capacity	- / W	2 / 1500 + 750	1 / 3750	1 / 3750	1 / 3750	1 / 3750	1 / 4500	1 / 4500	1 / 5400	1 / 5400	1 / 6500	1 / 7500	1 / 7500	1 / 9000	1 / 9000	1 / 13000	1 / 13000	
<b>Sound levels</b>																			
Sound power - radiated	Lo / Med / Hi	dB(A)	51 / 54 / 58	54 / 56 / 57	54 / 56 / 57	53 / 54 / 57	53 / 54 / 57	53 / 56 / 58	53 / 56 / 58	54 / 56 / 58	54 / 56 / 58	55 / 59 / 63	55 / 59 / 63	55 / 59 / 63	57 / 60 / 63	55 / 59 / 62	70 / 69 / 68	70 / 69 / 68	
NR	Lo / Med / Hi		34 / 37 / 40	33 / 34 / 37	33 / 34 / 37	33 / 35 / 38	33 / 35 / 38	34 / 37 / 41	34 / 37 / 41	36 / 40 / 43	36 / 40 / 43	39 / 43 / 46	39 / 43 / 46	39 / 43 / 46	36 / 39 / 44	36 / 39 / 44	56 / 54 / 52	56 / 54 / 52	
<b>Dimension</b>																			
Length	mm	900	1050	1050	1050	1050	1050	1250	1250	1250	1250	1250	1250	1250	1680	1680	1680	1680	
Width	mm	600	600	660	660	660	660	705	705	705	705	705	705	705	955	955	955	955	
Height	mm	439	460	460	460	460	460	513	513	513	513	513	583	513	770	770	770	770	
<b>Weight</b>																			
Operating weight	kg	80	100	112	100	100	112	133	133	135	140	144	149	149	253	253	259	262	

1) \*\*\* HWA: units without RCS, HRA: units with RCS, HBA: units with RCS + EH, HHA: units with EH. 2) Nominal cooling capacities based on: entering air temperature of 27 °C DB, 19 °C WB with entering water temperature of 30 °C. 3) Nominal heating capacities based on: entering air temperature of 20 °C DB, 15 °C WB with entering water temperature of 20 °C. 4) Absorbed power (compressor + fan) at nominal conditions. Check data and configuration on the technical documentation.

Accessories and options

Circuit breaker
Modbus RTU protocol-standard. Controller with BACnet MSTP - optional (BACnet IP, LON and Modbus TCP/IP available upon request)
EH - Electric heaters
General alarm dry contact

Accessories and options

Main switch
Motorized water valve
Room sensor
G3 filter [available upon request]

Accessories supplied loose

P-393446	RCS kit remote control with thermostat (POL822)
P-375281	SRC - mini BMS controller (only with Modbus RTU)

Accessories supplied loose

P-372061	Kit remote keyboard panel
----------	---------------------------





# ECOi-LOOP FS H · R407C

Water source heat pumps reversible.

Cooling capacity: 1,9 to 2,7 kW.

Heating capacity: 2,4 to 3,2 kW.



Optional controller.  
RCS remote control.



Optional controller.  
SRC - mini BMS controller.

+ SEE PAGE 546 FOR MORE DETAILS ABOUT WATER SOURCE HEAT PUMPS CONTROL SYSTEMS

## Operating limits

Air inlet temperature.

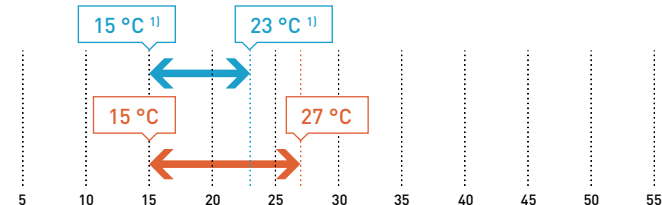

Water inlet temperature.

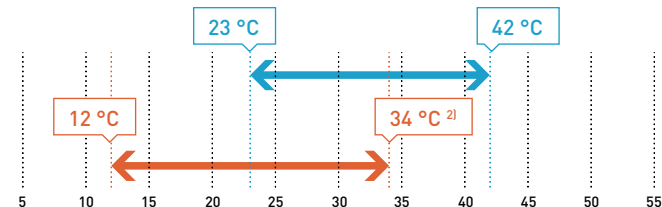

1) From 21 to 32 °C DB. 2) 32 °C for ECOi-LOOP FS 07 in low speed. \* Maximum water pressure 10 bars.

## The range at a glance

- 1 version: H (reversible)
- 1 size
- Vertical installation
- 4 versions: VC (standard version with cabinet), VCL (low height version with cabinet), VN (standard version without cabinet) and VNL (low height version without cabinet)
- EER up to 3,25 and COP up to 3,49
- Nominal air flow from 400 to 510 m<sup>3</sup>/h
- 3-speed AC fan (or optional low consumption EC fan)
- Many hydraulic and electric configurations available
- Front or bottom air intake
- Operating range: from 15 °C to 32 °C ambient air temperature
- Water inlet temperature from 12 °C to 42 °C

## Advantages

- Low sound levels: acoustic insulation between ventilation and compressor compartments
- Design and elaborate finish cabinet enabling harmonious integration (RAL9010)
- Low energy consumption EC fan (option)
- Highly customisable. Many air routing configurations and selection of hydraulic service side
- Easy access to components through a removable front panel
- Brazed stainless steel plate heat exchanger for improved efficiency
- 100% factory tested

## Equipment

- The refrigerant circuit comprises a rotary type hermetic compressor, a cycle reversal valve, a water/refrigerant heat exchanger, a liquid receiver, a finned coil, HP and LP pressure switches and 2 Schrader valves (HP and LP)
- The rotary type hermetic compressor, mounted on spring anti-vibration mounts, is integrated in a compartment coated with reinforced acoustic insulation. It is also equipped with internal thermal protection
- The units are equipped with a control system (POL423) utilising Modbus RTU
- The water/refrigerant heat exchanger is made of brazed stainless steel plates, for improved efficiency
- RAL9010 painted cabinet for versions VC and VCL
- Condensate drain pan with an anti-corrosion treatment
- A G2 air filter is provided within the unit

## AC SELECT.

Smart and user-friendly selection tool. Configure your air conditioning solution at required conditions:  
<https://acselect.panasonic.eu/>





## Technical features

ECOi-LOOP FS H - reversible		P-LPFSM12HA	
Total cooling capacity <sup>1)</sup>	W	2743	
Sensible cooling capacity <sup>1)</sup>	W	2340	
EER		3,25	
Heating capacity <sup>2)</sup>	W	3156	
COP		3,49	
<b>Ventilation</b>			
Number of fans		1	
Air flow	Lo / Med / Hi	m <sup>3</sup> /h	400 / 460 / 510
Motor power (with AC / EC fan)		W	75 / 40
Air filter	Number / efficiency		1 / G2
<b>Hydraulic circuit</b>			
Number of plate heat exchanger		1	
Maximum water pressure	bar	10	
Nominal water flow	l/h	616	
WPD at nominal water flow	kPa	12	
Connections - inlet/outlet (ø)	Inch	ISO G ½ INT	
Condensate outlet - external (Ø)	mm	15 x 20	
<b>Refrigerant circuit</b>			
Number of refrigerant circuits		1	
Compressor type		Rotary	
Load	g	750	
<b>Electrical data</b>			
Power supply	Voltage	V	230
	Phase		Single phase
	Frequency	Hz	50 ±10%
Input power - AC fan <sup>3)</sup>	Cooling	W	892
	Heating	W	954
<b>Sound levels - AC fan</b>			
Sound pressure <sup>4)</sup>	Lo / Med / Hi	dB(A)	43 / 45 / 46
NR <sup>4)</sup>	Lo / Med / Hi		38 / 40 / 41
<b>Dimension</b>			
Standard with cabinet (VC)	LxWxH	mm	1138 x 251 x 720 min / 750 max (821 with feet)
Low height with cabinet (VCL)	LxWxH	mm	1323 x 251 x 580 min / 610 max (683 with feet)
Standard without cabinet (VN)	LxWxH	mm	1043,5 (1086 with feet) x 229 x 667,5 min / 697,5 max (769,5 with feet)
Low height without cabinet (VNL)	LxWxH	mm	1182,5 (1183 with feet) x 229 x 525 min / 555 max (627 with feet)
<b>Weight</b>			
Without cabinet / with cabinet - operating		kg	60 / 75

1) Nominal cooling capacities based on: entering air temperature of 27 °C DB/19 °C WB, with entering water temperature of 30 °C. 2) Nominal heating capacities based on: entering air temperature of 20 °C DB/15 °C WB, with entering water temperature of 20 °C. 3) Absorbed power (compressor + fan) at nominal conditions. 4) Sound pressure considering a local of 100 m<sup>3</sup>, a reverberation time of 0,5 sec and a distance of 1 m.

### Accessories and options

Modbus RTU protocol-standard. Controller with BACnet MSTP - optional (BACnet IP, LON and Modbus TCP/IP available upon request)

EC fan

Feet

### Accessories supplied loose

**P-393446** RCS kit remote control with thermostat (POL822)

**P-375281** SRC - mini BMS controller (only with Modbus RTU)

**P-372061** Kit remote keyboard panel

### Accessories and options

General remote alarm contact

Low noise

Many electric, hydraulic and aeraulic configurations

Thermal overload

### Accessories supplied loose

**P-372734** Kit front air intake cabinet

**P-372642** Kit front air intake cabinet (low height)





# ECOi-LOOP-N FS H · R513A

Water source heat pumps reversible.

Cooling capacity: 1,7 to 2,0 kW.

Heating capacity: 1,8 to 2,6 kW.



Optional controller.  
RCS remote control.



Optional controller.  
SRC - mini BMS controller.

+ SEE PAGE 546 FOR MORE DETAILS ABOUT WATER SOURCE HEAT PUMPS CONTROL SYSTEMS

## Operating limits

Air inlet temperature.

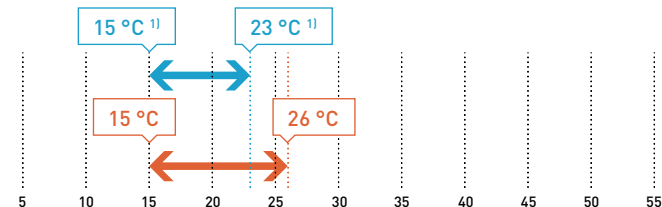

Water inlet temperature.

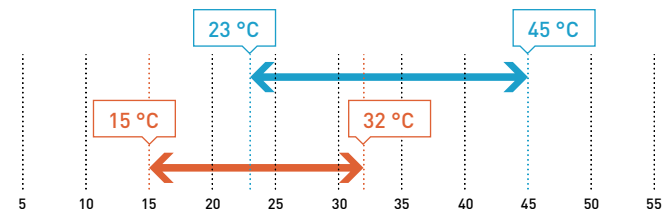

1) From 21 to 32 °C DB. \* Maximum water pressure 10 bars.

## The range at a glance

- 1 version: H (reversible)
- 2 sizes
- Vertical installation
- 4 versions: VC (standard version with cabinet), VCL (low height version with cabinet), VN (standard version without cabinet) and VNL (low height version without cabinet)
- EER up to 4,9 and COP up to 4,6
- Nominal air flow from 250 to 460 m<sup>3</sup>/h
- 3-speed AC fan (or optional low consumption EC fan)
- Many hydraulic and electric configurations available
- Front or bottom air intake
- Operating range: from 15 °C to 32 °C ambient air temperature
- Water inlet temperature from 15 °C to 45 °C

## Advantages

- Low sound levels: acoustic insulation between ventilation and compressor compartments
- Design and Elaborate finish cabinet enabling harmonious integration (RAL9010)
- Low energy consumption EC fan (option)
- Highly customisable. Many air routing configurations and selection of hydraulic service side
- Easy access to components through a removable front panel
- Brazed stainless steel plate heat exchanger for improved efficiency (coaxial exchanger upon request)
- 100% factory tested

## Equipment

- The refrigerant circuit comprises a rotary type hermetic compressor, a cycle reversal valve, a water/refrigerant heat exchanger, a liquid receiver, a capillary expansion device, a finned coil, HP and LP pressure switches and 2 Schrader valves (HP and LP)
- The rotary type hermetic compressor is installed in a compartment covered with a 20 mm thick Isofeutre thermal-acoustic insulation. It is also equipped with internal thermal protection
- The units are equipped with a control system (POL423) utilising Modbus RTU
- The water/refrigerant heat exchanger is made of brazed stainless steel plates, for improved efficiency. A coaxial heat exchanger is available on request
- RAL9010 painted cabinet for versions VC and VCL
- Condensate drain pan with an anti-corrosion treatment
- A G2 air filter is provided within the unit

## AC SELECT.

Smart and user-friendly selection tool. Configure your air conditioning solution at required conditions:  
<https://acselect.panasonic.eu/>







## Technical features

ECOi-LOOP-N FS H - reversible			P-LPFSN07HA	P-LPFSN09HA
Total cooling capacity <sup>1)</sup>	W		1690	2040
Sensible cooling capacity <sup>1)</sup>	W		1410	1600
Input power (with EC / AC fan) <sup>2)</sup>	W		345 / 355	480 / 487
EER according to EN 14511 (with EC / AC fan)			4,9 / 4,75	4,25 / 4,19
Heating capacity <sup>3)</sup>	W		1790	2630
Input power (with EC / AC fan) <sup>2)</sup>	W		395 / 405	610 / 617
COP according to EN 14511 (with EC / AC fan)			4,6 / 4,41	4,31 / 4,26
<b>Ventilation</b>				
Air flow	Min	m <sup>3</sup> /h	250	340
	Nominal	m <sup>3</sup> /h	340	400
	Max	m <sup>3</sup> /h	400	460
Nominal input power (with EC / AC fan)	W		15 / 25	20 / 27
Motor power (with EC / AC fan)	W		40 / 75	40 / 75
Air filter	Number / efficiency		1 / G2	1 / G2
<b>Hydraulic circuit</b>				
Number of plate heat exchanger			1	1
Maximum water pressure	Bar		10	10
Nominal water flow	Cooling <sup>1)</sup>	l/h	351	434
	Heating <sup>3)</sup>	l/h	405	586
Cutoff water flow		l/h	180	180
WPD at nominal water flow	Cooling <sup>1)</sup>	kPa	3,8	5,8
	Heating <sup>3)</sup>	kPa	5,1	10,8
Hydraulic connections - inlet/outlet	Inch		Female ISO G ½ INT	Female ISO G ½ INT
Condensate outlet (Ø)	mm		15 x 20	15 x 20
<b>Refrigerant circuit</b>				
Number of refrigerant circuits			1	1
Type of compressor			Rotary	Rotary
Load	g		500	490
<b>Electrical data</b>				
Power supply	Voltage	V	230	230
	Phase		Single phase	Single phase
	Frequency	Hz	50 ±10%	50 ±10%
Maximum current <sup>4)</sup>	A		4,6	5,7
Starting current <sup>5)</sup>	A		16	16,5
<b>Sound levels</b>				
Sound power Lw	Lo / Med / Hi	dB(A)	47,2 / 49,8 / 51,5	49,8 / 51,5 / 54,3
Sound pressure Lp	Lo / Med / Hi	dB(A)	38,2 / 40,8 / 42,5	40,8 / 42,5 / 45,3
NR	Lo / Med / Hi	dB(A)	32 / 34 / 36	34 / 36 / 40
<b>Sound levels - extra low noise version</b>				
Sound power Lw	Lo / Med / Hi	dB(A)	42,5 / 44,6 / 46,5	44,7 / 46,5 / 48,6
Sound pressure Lp	Lo / Med / Hi	dB(A)	33,5 / 35,6 / 37,5	35,7 / 37,5 / 39,6
NR	Lo / Med / Hi	dB(A)	28 / 30 / 32	30 / 32 / 34
<b>Dimension</b>				
Standard with cabinet (VC)	LxWxH	mm	1138 x 260 x 720 min / 750 max (821 with feet)	1138 x 260 x 720 min / 750 max (821 with feet)
Low height with cabinet (VCL)	LxWxH	mm	1322 x 260 x 582 min / 612 max (683 with feet)	1322 x 260 x 582 min / 612 max (683 with feet)
Standard without cabinet (VN)	LxWxH	mm	1055 (1084 with feet) x 241 x 667 min / 697 max (769 with feet)	1055 (1084 with feet) x 241 x 667 min / 697 max (769 with feet)
Low height without cabinet (VNL)	LxWxH	mm	1185 (1270 with feet) x 241 x 525 min / 555 max (626 with feet)	1185 (1270 with feet) x 241 x 525 min / 555 max (626 with feet)
<b>Weight</b>				
Without cabinet / with cabinet - operating	kg		55 / 70	58 / 73

1) Nominal cooling capacities based on: entering air temperature of 27 °C DB/19 °C WB, with entering water temperature of 30 °C. 2) Absorbed power (compressor + fan) at nominal conditions. 3) Nominal heating capacities based on: entering air temperature of 20 °C DB/15 °C WB, with entering water temperature of 20 °C. 4) Maximum currents are given at +/- 5%. 5) Starting currents are given at +/- 10%.

### Accessories and options

Modbus RTU protocol-standard. Controller with BACnet MSTP - optional (BACnet IP, LON and Modbus TCP/IP available upon request)

EC fan

Feet

### Accessories supplied loose

**P-393446** RCS kit remote control with thermostat (POL822)

**P-375281** SRC - mini BMS controller (only with Modbus RTU)

**P-372061** Kit remote keyboard panel

### Accessories and options

General remote alarm contact

Low noise

Many electric, hydraulic and aeraulic configurations

Thermal overload

### Accessories supplied loose

**P-372734** Kit front air intake cabinet

**P-372642** Kit front air intake cabinet (low height)



# Water source heat pumps control systems



## SRC - mini BMS controller

### Smart controller. Mini building management system.

With the SRC - mini BMS controller - you can now remotely control multiple units or zones of units with a single interface.

Its time programming function offers you the possibility to fully control and rationalise the energy consumption of your HVAC system.

This smart controller is intuitive and easy to use thanks to its color touch screen, logical structure and clear control icons.

The modern and refined design fits perfectly in to any modern interior.

- Supervise fan coil units, chillers/heat pumps, air handling units and water source heat pumps
- Manage up to 31 units
- Communicate via Modbus protocol
- Time programming function
- A modern and refined design
- 3,5" color touch screen
- Wall mounting

### Used as a mini BMS.

With the SRC you can create up to 15 zones including several Panasonic units belonging to the same product lines.

- Chillers / heat pumps
- Air handling units
- Fan coil units

### Used as a remote control.

The SRC can also control, in a unique zone, one or several units belonging to the same product line.

- Fan coil units
- Water source heat pumps

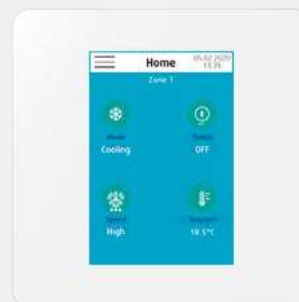

## Control system with protocol communication

### Ventilation:

- Compatibility: 3-speed AC fan motor or EC fan motor
- Manual speed (3 levels)
- Automatic speed

### Communication:

- Modbus RTU or BACnet MSTP
- Modbus TCP/IP or LON or BACnet IP upon request

### Operating mode:

- OFF / Comfort / ECO

### Function type:

- Summer
- Winter
- Ventilation
- Auto changeover (adjustment of the automatic mode according to the setpoint)

### Setpoint:

- Extract air temperature
- Room thermostat
- BMS

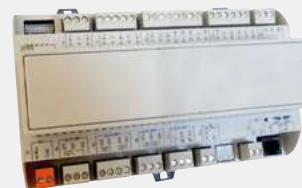

## RCS remote control

### Main functions:

- ON / OFF
- Comfort / ECO modes
- Operating mode setting
- Setpoint adjustment
- Room temperature (OFF)
- Ventilation setting (manual or automatic)
- Time display and setting
- Alarm summary
- Zoning (up to 15 units)
- Scheduling





## Fan coil units

Panasonic offers you a complete range of fan coil units. Stylish, premium units for residential projects with a sophisticated, compact design and customizable, flexible units for commercial applications with a wide range of options and accessories available.





<b>Aquarea Air Smart fan coils</b>	→ 550
Quick selection guide - Aquarea Air Smart fan coils	→ 554
Aquarea Air Smart fan coil floor standing	→ 556
Aquarea Air Smart fan coil wall-mounted	→ 557
Aquarea Air Smart fan coil ducted thin / ducted	→ 558
Aquarea Air Smart fan coil ducted multi zone thin / ducted multi zone	→ 560
Accessories and control Aquarea Air Smart fan coil	→ 584

<b>Fan coil units</b>	→ 552
Fan coil wall unit - FK1	→ 553
Quick selection guide - Fan coil units	→ 555
Fan coil comfort AC fan	→ 572
Fan coil comfort EC fan	→ 564
Fan coil cassette AC fan	→ 566
Fan coil cassette EC fan	→ 568
Fan coil wall DC fan – FK1	→ 570
Fan coil wall AC fan	→ 572
Fan coil duct EC fan	→ 574
Fan coil high static duct AC fan	→ 576
Fan coil high static duct EC fan	→ 578
Fan coil controllers	→ 580

# Aquarea Air Smart fan coils

Stylish, compact fan coil units for high comfort and energy savings.



## Remote control with Aquarea Home App.

\* Requires Wi-Fi control or Home Network Hub PCZ-ESW737.



Aquarea Home



Download on the  
App Store



GET IT ON  
Google Play

## AC SELECT.

Smart and user-friendly the new air conditioning selection program: <https://acselect.panasonic.eu/>



Aquarea Air Smart fan coils have a minimal visual impact and can be elegantly integrated into any home or office environment, adapting to any type of furniture.

Designed to provide both heating and cooling in one compact unit, they maximise energy savings when combined with an Aquarea Heat Pumps.

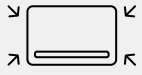

Sophisticated and slim design, with an elegant metal body.

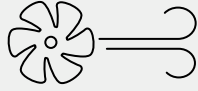

Self-modulated air flow control by the unit (PI logic) and brushless DC fan motor with Inverter.



Versatile with a range of installation options.

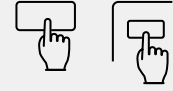

Wide range of control options, including on-board or wall-mounted controls.

### Self-modulated air-flow control by the unit.

The fan speed is no longer "stepped" but continuously modulated with proportional and integrative logic: this reduces both noise and annoying air movements.

### Aquarea Air Smart fan coil floor standing.

Even narrower and thinner fan coils.



### Aquarea Air Smart fan coil wall-mounted.

The thinnest and most quietest in its class.



### Aquarea Air Smart fan coil ducted / ducted thin.

Variable speed, constant air flow.

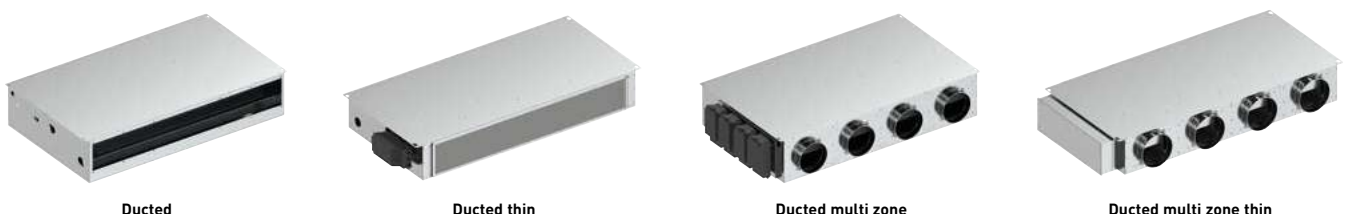

Ducted

Ducted thin

Ducted multi zone

Ducted multi zone thin

## Fan coil units

Design to meet all needs, they have a comprehensive range of options and accessories available and a wide range of technological controllers: individual, groups and centralized.



### Energy savings and comfort

- Low consumption solutions with high efficiency fan motor
- High level of energy performance

### Quiet operation

- Optimised fan speed staging
- Reinforced acoustic insulation
- Profiled air diffusers

### Fully customizable

- Many factory-mounted options
- Choice of service side for hydraulic and electrical connections

### Wide technological range of controls







- Individual controllers with intuitive user interface.
- Plologic group controller to control multiple units with a single control
- Plologic + BMS and SRC centralized and group control of different climatic zones with different settings



# New fan coil wall unit - FK1

First Panasonic water fan coil unit integrated with nanoe™ X technology. Wall units with new modern, flat design with a stylish matte white finish. The fan coils are integrated with nanoe™ X technology to improve protection 24/7 (Generator Mark 3). They are ideal for commercial and residential applications in combination with Aquarea Heat Pumps.



					
DC fan.	Quiet operation.	Stylish design.	Motorized louvers.	Wide range of control options.	Service App*. <small>* CONEX control is required.</small>

## Greater flexibility in managing indoor climate

Fan coil wall FK1 allows precise control over the direction and volume of air flow thanks to motorized louvers which can be easily adjusted to suit different room layouts and usage patterns. With the ability to adjust air flow direction, motorized louvers help maintain a consistent and comfortable indoor environment.







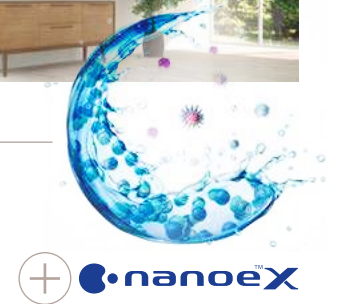

## Improved indoor air quality with nanoe™ X

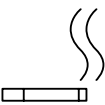
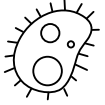
Fan coil wall FK1 is equipped with nanoe™ X for improved indoor air quality and higher level of performance. It comes with nanoe X Generator Mark 3, the latest of the continuously evolving nanoe™ X technology with the benefits of hydroxyl radicals.

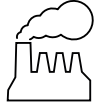

## 7 effects of nanoe™ X – Panasonic unique technology.

<b>Deodorises</b>	<b>Capacity to inhibit 5 types of pollutants</b>					<b>Moisturises</b>
						
Odours	Bacteria and viruses	Mould	Allergens	Pollen	Hazardous substances	Skin and hair

\* Refer to <https://aircon.panasonic.eu> for more details and validation data.







## Smart controls: Compatible with CONEX Series.

### CONEX. Devices and apps.

CONEX provides comfort and control for varying user needs. Accessible, flexible, and scalable with different controllers and apps. Perfectly meeting requirements of modern controls for end user, installer, and service.









# Quick selection guide - Aquarea Air Smart fan coils

Page	Size	Cooling and heating capacity <sup>1) 2) 3)</sup> (kW)	Air flow - Max (m <sup>3</sup> /h)	Pressure (Pa)	Fan	Dimension HxWxD (mm)
<b>P. 556</b> 	Fan coil floor standing	10 0,73 0,69	146	10		580 x 680 x 119
		20 1,36 1,50	294	10		580 x 880 x 119
		30 2,08 2,15	438	13		580 x 1080 x 119
		35 2,39 2,56	567	13		580 x 1280 x 119
		40 2,57 2,78	663	13		580 x 1480 x 119
<b>P. 557</b> 	Fan coil wall-mounted	10 0,88 0,98	228	—		335 x 815 x 128
		15 1,08 1,30	331	—		335 x 1015 x 128
		20 1,21 1,49	440	—		335 x 1215 x 128
		40 2,66 3,04	788	—		335 x 1215 x 215
<b>P. 558</b> 	Fan coil ducted thin	15 1,14 1,32	290	100		185 x 590 x 575
		20 1,84 1,80	390	90		185 x 790 x 575
		25 2,17 2,32	550	120		185 x 990 x 575
		35 2,40 2,76	680	110		185 x 1190 x 575
		45 2,80 3,98	870	140		185 x 1440 x 575
<b>P. 558</b> 	Fan coil ducted	20 1,37 1,48	390	90		240 x 590 x 695
		25 1,86 2,04	560	130		240 x 790 x 695
		35 2,38 2,63	730	110		240 x 990 x 695
		45 3,22 3,77	905	140		240 x 1190 x 695
		55 3,97 4,23	1150	140		240 x 1440 x 695
<b>P. 560</b> 	Fan coil ducted multi zone thin	30 1,97 2,11	480	100		185 x 790 x 575
		45 2,97 3,19	720	100		185 x 990 x 575
		60 3,68 5,76	960	100		185 x 1190 x 575
		65 4,15 4,75	1200	100		185 x 1440 x 575
<b>P. 560</b> 	Fan coil ducted multi zone	30 3,80 3,90	810	100		240 x 790 x 695
		45 3,77 4,16	1215	100		240 x 990 x 695
		60 4,87 5,42	1620	100		240 x 1190 x 695
		75 6,31 6,87	2025	100		240 x 1440 x 695

1) Data for medium fan speed. Fan standard factory set speeds. 2) Cooling capacity: According to Eurovent standard. Air: 27 °C DB/19 °C WB, chilled water: 7 °C/12 °C. 3) Heating capacity: According to Eurovent standard. Air: 20 °C, hot water: 45 °C/40 °C.

\* The Aquarea Air range aligns with the Aquarea commercial policy.

# Quick selection guide - Fan coil units

Page	Size	Cooling and heating capacity <sup>1)</sup> (kW)	Air flow <sup>1)</sup> (m <sup>3</sup> /h)	Pressure (Pa)	Fan	Dimension <sup>2)</sup> HxWxD (mm)
<b>P. 562</b> 	10	2,0 2,3	417	—	AC/EC	477 x 766 x 225
	20	2,1 2,5	413	—	AC/EC	477 x 766 x 225
	30	1,8 2,7	345	—	AC/EC	477 x 951 x 225
	40	4,2 4,5	678	—	AC/EC	477 x 1136 x 225
	50	5,0 5,2	816	—	AC/EC	477 x 1321 x 225
	60	5,2 5,8	912	—	AC/EC	477 x 1506 x 225
	70	6,6 7,2	1050	—	AC/EC	575 x 1319 x 225
	80	8,4 8,5	1063	—	EC	575 x 1506 x 225
<b>P. 566</b> 	20	2,4 2,7	659	—	AC/EC	341 x 595 x 595
	30	4,0 3,7	734	—	AC/EC	341 x 595 x 595
	40	4,7 5,3	900	—	AC/EC	341 x 595 x 595
	50	6,1 6,8	979	—	AC/EC	358 x 849 x 849
	60	7,2 8,5	1159	—	AC/EC	358 x 849 x 849
	70	9,6 11,0	1598	—	AC/EC	358 x 849 x 849
<b>P. 570</b> 	19	1,9 2,2	345	—	DC	295 x 890 x 244
	24	2,4 2,7	416	—	DC	295 x 890 x 244
	27	2,7 3,0	480	—	DC	295 x 890 x 244
	36	3,6 4,0	710	—	DC	295 x 890 x 244
	45	4,5 5,1	753	—	DC	295 x 1060 x 249
	52	5,2 5,3	879	—	DC	295 x 1060 x 249
<b>P. 572</b> 	7	1,7 1,7	360	—	AC	275 x 845 x 180
	9	2,5 2,8	551	—	AC	275 x 845 x 180
	18	3,6 4,1	680	—	AC	298 x 940 x 200
	22	4,0 4,5	850	—	AC	298 x 940 x 200
<b>P. 574</b> 	10	1,5 1,8	357	0-70	EC	223 x 633 x 631
	15	2,1 2,6	491	0-90	EC	223 x 733 x 631
	20	2,7 2,6	599	0-90	EC	223 x 833 x 631
	25	3,2 3,4	642	0-90	EC	223 x 933 x 631
	30	4,8 5,0	1068	0-90	EC	223 x 933 x 631
	40	6,7 7,1	1293	0-90	EC	223 x 1233 x 653
<b>P. 576</b> 	7	5,6 6,7	1125	0-110	AC/EC	250 x 1200 x 698
	15	13,3 15,5	2830	0-200	AC/EC	375 x 1380 x 798
	18	13,9 18,0	2830	0-200	AC/EC	375 x 1380 x 798
	21	17,0 17,8	2830	0-200	AC/EC	375 x 1380 x 798
	24	21,2 24,3	3736	0-220	AC/EC	450 x 1500 x 798
	27	24,8 25,0	3736	0-220	AC/EC	450 x 1500 x 798

1) Data for fan coil comfort, cassette and duct EC fan 2-pipe version. Data for fan coil high static duct AC fan / 2-pipe version. 2) Fan coil comfort: with cabinet / without feet / vertical installation. Fan coil cassette: casing + IRYS COANDA 360 diffuser. Fan coil duct and high static duct: horizontal installation / configuration: rectangular return and discharge.

# Aquarea Air Smart fan coil floor standing

Slim chassis profile, only 119 mm / RAL 9003 / DC Inverter – maximising comfort and energy savings / Modulated air flow.

**Possible configurations:** Left or right water connections / 2 or 3 way valves as accessories / On-board or wall mounted control or PCB for analog input (0-10 V)



Model (the complete model codes are shown in the table below)		P-FAL10	P-FAL20	P-FAL30	P-FAL35	P-FAL40
<b>Fan speed</b> <sup>1)</sup>		<b>Min / Med / Max</b>	<b>Min / Med / Max</b>	<b>Min / Med / Max</b>	<b>Min / Med / Max</b>	<b>Min / Med / Max</b>
Total cooling capacity <sup>2)</sup>	kW	0,43/0,73/0,91	0,75/1,36/2,12	1,15/2,08/2,81	1,32/2,39/3,30	1,36/2,57/3,71
Sensible capacity <sup>2)</sup>	kW	0,29/0,51/0,71	0,59/1,04/1,54	0,83/1,51/2,11	1,02/1,84/2,65	1,05/1,98/2,90
Water flow <sup>2)</sup>	l/h	73,67/125,07/155,91	128,50/233,01/363,22	197,03/356,36/481,43	226,15/409,48/565,39	—
Water pressure drop <sup>2)3)</sup>	kPa	5,7/10,2/12,1	1,9/4,3/8,2	2,7/9,9/17,1	2,5/8,8/18,0	—
Heating capacity <sup>4)</sup>	kW	0,37/0,69/1,00	0,82/1,50/2,19	1,19/2,15/2,99	1,45/2,56/3,73	1,47/2,78/4,23
Water flow <sup>4)</sup>	l/h	65,11/120,91/179,87	144,60/269,80/389,71	211,61/380,89/532,55	259,22/456,72/671,86	—
Water pressure drop <sup>3)4)</sup>	kPa	2,6/6,8/9,1	1,5/4,3/9,2	2,7/9,3/19,1	3,0/8,9/21,2	—
<b>Sound levels</b>						
Sound power	dB(A)	37/47/54	37/47/54	37/47/57	37/47/55	37/48/58
Sound pressure <sup>5)</sup>	dB(A)	24/33/41	25/34/42	26/34/44	26/35/46	28/38/47
<b>Ventilation</b>						
Number of fans		1	1	1	1	1
Air flow	m <sup>3</sup> /h	49/91/146	124/210/294	194/318/438	302/410/567	364/479/663
Maximum static pressure	Pa	10	10	13	13	13
<b>Electrical data</b>						
Power supply	V / Phase / Hz	V	230/1/50	230/1/50	230/1/50	230/1/50
Consumption	W	7,0/9,0/13,0	14,0/18,0/22,0	16,0/20,0/24,0	18,0/22,0/26,5	—
<b>Water connections</b>						
Hydraulic connections type		Eurokonus	Eurokonus	Eurokonus	Eurokonus	Eurokonus
Hydraulic connections	Inch	¾	¾	¾	¾	¾
<b>Dimension and weight</b>						
Dimension / Weight	H x W x D	mm / kg	580 x 680 x 119/13	580 x 880 x 119/16	580 x 1080 x 119/18	580 x 1280 x 119/20
			580 x 1480 x 119/23			

1) Fan standard factory set speeds. 2) According to Eurovent standard. Air: 27 °C DB/19 °C WB, chilled water: 7 °C/12 °C. 3) Pressure loss by corresponding nominal flow. 4) According to Eurovent standard. Air: 20 °C, hot water: 45 °C/40 °C. 5) Informative data, considering an hypothetical sound attenuation of the room and installation of 9 dB(A).

## Option 1. Standard configurations with built-in accessories

### Fan coil with on-board display

Left-hand piping, vertical installation, built-in 3 way valve

P-FAL10SC-HLE

P-FAL20SC-HLE

P-FAL30SC-HLE

P-FAL35SC-HLE

P-FAL40SC-HLE

### Fan coil with wall-mounted control

Left-hand piping, vertical installation, built-in 3 way valve

P-FAL10SC-RLE

P-FAL20SC-RLE

P-FAL30SC-RLE

P-FAL35SC-RLE

P-FAL40SC-RLE

Control (required, to be ordered separately)	With Modbus	<b>PCZ-EEB749</b>
	With integrated Wi-Fi	<b>PCZ-EFB749</b>

## Option 2. Configure your own Aquarea Air Smart fan coil floor standing unit

Left-hand piping	Right-hand piping
------------------	-------------------

P-FAL10SC-00E

P-FAL10DC-00E

P-FAL20SC-00E

P-FAL20DC-00E

P-FAL30SC-00E

P-FAL30DC-00E

P-FAL35SC-00E

P-FAL35DC-00E

P-FAL40SC-00E

P-FAL40DC-00E

<b>Control options (required)</b>	On-board display	With Modbus	<b>PCZ-ECA844</b>
		With integrated Wi-Fi	<b>PCZ-EWA844</b>
	Wall-mounted control	With Modbus	<b>PCZ-ESE845 + PCZ-EEB749</b>
		With integrated Wi-Fi	<b>PCZ-ESE845 + PCZ-EFB749</b>
	PCB for analog control (0-10 V)		<b>PCZ-B10842</b>

<b>Valve kits (optional)</b>	3 way valve with motor	<b>PCZ-V30720</b>
	2 way valve with motor	<b>PCZ-V20139</b>

<b>Condensate drip tray for horizontal installation (optional)</b>	For P-FAL10	<b>PCZ-GB0520</b>
	For P-FAL20	<b>PCZ-GB0521</b>
	For P-FAL30	<b>PCZ-GB0522</b>
	For P-FAL40	<b>PCZ-GB0523</b>
	For P-FAL50	<b>PCZ-GB0524</b>

### Accessories and options

PCZ-LC0158 Feet for floor pipe cover

### Accessories and options

PCZ-LC0606 Feet for anchoring the unit to the floor

## Control options.

On-board display with Modbus or integrated Wi-Fi.



Wall-mounted control with Modbus or integrated Wi-Fi.

PCZ-EEB749 /  
PCZ-EFB749



PCB for analog control (0-10 V).

PCZ-B10842

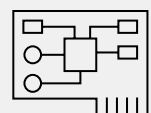

# Aquarea Air Smart fan coil wall-mounted

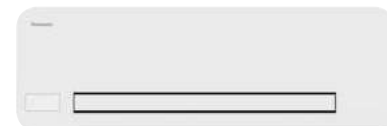

Slim chassis profile, only 128 mm / RAL 9003 / DC Inverter – maximising comfort and energy savings / Modulated air flow.

**Possible configurations:** Left or right water connections / 2 or 3 way valves as accessories / On-board or wall mounted control or PCB for analog input (0-10 V)

Model (the complete model codes are shown in the table below)			P-FMM10	P-FMM15	P-FMM20	P-FMM40
Fan speed <sup>1)</sup>			Min / Med / Max	Min / Med / Max	Min / Med / Max	Min / Med / Max
Total cooling capacity <sup>2)</sup>	kW		0,49/0,88/1,24	0,62/1,08/1,61	0,70/1,21/1,94	1,32/2,66/3,94
Sensible capacity <sup>2)</sup>	kW		0,37/0,70/0,98	0,52/0,86/1,27	0,57/1,02/1,52	1,08/2,05/2,92
Water flow <sup>2)</sup>	l/h		84,00/150,80/212,40	106,20/185,00/275,80	119,90/207,30/332,40	226,40/455,30/674,30
Water pressure drop <sup>2)</sup>	kPa		4,8/10,5/11,7	4,7/5,6/5,1	5,5/5,4/5,3	1,8/6,0/12,1
Heating capacity <sup>3)</sup>	kW		0,54/0,98/1,45	0,76/1,30/1,93	0,78/1,49/2,28	1,63/3,04/4,44
Water flow <sup>3)</sup>	l/h		97,00/176,30/264,50	139,30/239,80/354,40	141,10/273,30/414,40	296,40/547,00/800,90
Water pressure drop <sup>3)</sup>	kPa		5,1/12,0/16,3	4,8/6,3/7,2	6,0/6,4/8,1	2,3/6,9/14,1
<b>Sound levels</b>						
Sound power	dB(A)		35/46/53	36/47/54	37/48/58	38/48/62
Sound pressure <sup>4)</sup>	dB(A)		25/33/40	25/34/41	26/34/42	27/37/51
<b>Ventilation</b>						
Air flow	m <sup>3</sup> /h		84/155/228	124/229/331	138/283/440	230/480/788
<b>Electrical data</b>						
Power supply	V / Phase / Hz	V	230/1/50	230/1/50	230/1/50	230/1/50
Consumption		W	5/8/19	5/9/20	5/11/29	8/23/30
<b>Water connections</b>						
Hydraulic connections type			Eurokonus	Eurokonus	Eurokonus	Eurokonus
Hydraulic connections	Inch		¾	¾	¾	¾
<b>Dimension and weight</b>						
Dimension / Weight	HxWxD	mm / kg	335x815x128/14	335x1015x128/16	335x1215x128/19	335x1215x215/24

1) Fan standard factory set speeds. 2) According to Eurovent standard. Air: 27 °C DB/19 °C WB, chilled water: 7 °C/12 °C. 3) According to Eurovent standard. Air: 20 °C, hot water: 45 °C/40 °C. 4) Informative data, considering an hypothetical sound attenuation of the room and installation of 9 dB(A).

## Option 1. Standard configurations with built-in accessories

Fan coil with on-board display and wireless IR control		
Right-hand piping, built-in 3 way valve		
P-FMM10DC-QNE		
P-FMM15DC-QNE		
P-FMM20DC-QNE		
P-FMM40DC-QNE		
Fan coil with wall-mounted control		
Right-hand piping, built-in 3 way valve		
P-FMM10DC-RNE		
P-FMM15DC-RNE		
P-FMM20DC-RNE		
P-FMM40DC-RNE		
Control (required, to be ordered separately)	With Modbus	PCZ-EEB749
	With integrated Wi-Fi	PCZ-EFB749

## Option 2. Configure your own Aquarea Air Smart fan coil wall-mounted unit

Fan coil with on-board display and wireless IR control		
Left-hand piping	Right-hand piping	
P-FMM10SC-Q0E	P-FMM10DC-Q0E	
P-FMM15SC-Q0E	P-FMM15DC-Q0E	
P-FMM20SC-Q0E	P-FMM20DC-Q0E	
—	P-FMM40DC-Q0E	
Fan coil with wall-mounted control		
Left-hand piping	Right-hand piping	
P-FMM10SC-R0E	P-FMM10DC-R0E	
P-FMM15SC-R0E	P-FMM15DC-R0E	
P-FMM20SC-R0E	P-FMM20DC-R0E	
—	P-FMM40DC-R0E	
Control (required, to be ordered separately)	With Modbus	PCZ-EEB749
	With integrated Wi-Fi	PCZ-EFB749
Fan coil with PCB for analog control (0-10 V)		
Left-hand piping	Right-hand piping	
P-FMM10SC-V0E	P-FMM10DC-V0E	
P-FMM15SC-V0E	P-FMM15DC-V0E	
P-FMM20SC-V0E	P-FMM20DC-V0E	
—	P-FMM40DC-V0E	
Valve kits (optional)		
PCZ-V30688	3 way valve with motor for models 10, 15, 20	
PCZ-V30718	3 way valve with motor for model 40	
PCZ-V20687	2 way valve with motor for models 10, 15, 20	
PCZ-V20139	2 way valve with motor for model 40	

## Control options.

On-board display with Modbus or integrated Wi-Fi.



Wall-mounted control with Modbus or integrated Wi-Fi.

PCZ-EEB749 /  
PCZ-EFB749



PCB for analog control (0-10 V).

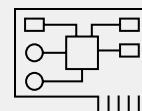

# Aquarea Air Smart fan coil ducted thin / ducted

Fan coil ducted units with cooling and heating.

Cooling capacity: 0,7 to 5,3 kW.

Heating capacity: 0,7 to 5,8 kW.



Optional controller.  
Wall-mounted control  
with Modbus.  
PCZ-EEB749



Optional controller.  
Wall-mounted control  
with integrated Wi-Fi.  
PCZ-EFB749



Optional controller.  
PCB for analog control  
(0-10 V).

+ CHECK PAGE 128 FOR A WIDER SELECTION OF ACCESSORIES

## The range at a glance

- Slim profile, only 185 mm for the thin version
- DC Inverter – maximising comfort and energy savings
- Modulated air flow
- Quiet operation
- Centrifugal fan with single motor impeller
- Vertical or horizontal installation

## Possible configurations

- Left or right water connections
- 2 or 3 way valves as accessories
- Wall-mounted control or PCB for analog input (0-10 V)

High efficiency ducted fan coil for high comfort and quiet operation thanks to self modulating airflow control.

## Ducted thin, designed to fit any space

With a height of only 185 mm, the thin version is even more versatile than the classic version and fits perfectly into any wall or false ceiling with either horizontal or vertical installation.

### Ducted thin



## High installation flexibility.

### Horizontal installation.

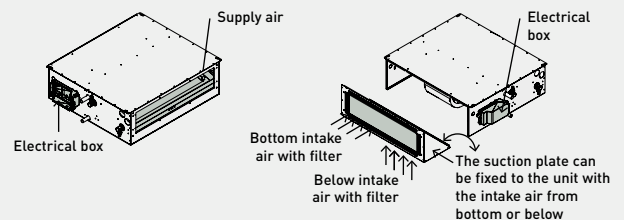

### Vertical installation.

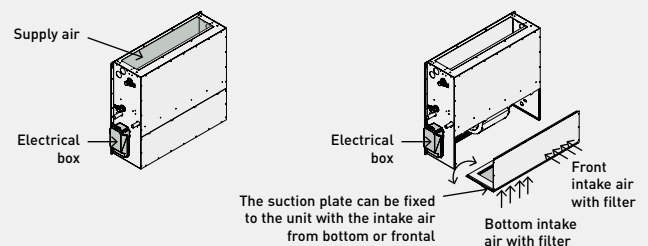

## Technical features

		Ducted thin					Ducted					
Model (the complete model codes are shown in the table below)		P-FTN15	P-FTN20	P-FTN25	P-FTN35	P-FTN45	P-FSN20	P-FSN25	P-FSN35	P-FSN45	P-FSN55	
Fan speed <sup>1)</sup>		Min / Med / Max	Min / Med / Max	Min / Med / Max	Min / Med / Max	Min / Med / Max	Min / Med / Max	Min / Med / Max	Min / Med / Max	Min / Med / Max	Min / Med / Max	
Total cooling capacity <sup>2)</sup>	kW	0,66/1,14 /1,40	1,01/1,84 /2,10	1,23/2,17 /2,60	1,47/2,40 /3,30	1,72/2,80 /4,45	0,82/1,37 /1,88	1,27/1,86 /2,14	1,53/2,38 /2,97	1,81/3,22 /3,48	1,82/3,97 /5,31	
Sensible capacity <sup>2)</sup>	kW	0,46/0,84 /1,05	0,70/1,27 /1,50	0,88/1,56 /2,10	1,06/1,77 /2,45	1,23/2,33 /3,20	0,61/0,96 /1,48	0,93/1,43 /1,56	1,17/1,98 /2,92	1,33/2,58 /2,95	1,33/2,75 /3,65	
Water flow <sup>2)</sup>	l/h	113/195 /270	173/315 /405	211/373 /510	251/412 /610	295/481 /805	141/235 /322	218/319 /367	262/408 /509	310/552 /596	312/680 /910	
Water pressure drop <sup>2)3)</sup>	kPa	1,0/3,0 /5,0	2,0/5,0 /8,0	4,0/10,0 /17,0	2,0/5,0 /11,0	2,0/6,0 /14,0	9,2/11,8 /15,7	9,9/14,9 /19,4	2,4/2,8 /2,9	9,0/12,6 /14,6	4,1/16,1 /27,2	
Heating capacity <sup>4)</sup>	kW	0,68/1,32 /1,65	1,01/1,80 /2,10	1,32/2,32 /2,86	1,63/2,76 /3,71	1,89/3,98 /5,20	0,9/1,48 /1,98	1,36/2,04 /2,54	1,81/2,63 /3,45	1,96/3,77 /4,46	1,95/4,23 /5,73	
Water flow <sup>4)</sup>	l/h	115/222 /310	170/303 /440	235/410 /540	288/486 /730	329/692 /880	159/261 /349	239/360 /448	319/464 /608	346/665 /787	347/754 /1025	
Water pressure drop <sup>3)4)</sup>	kPa	1,0/3,0 /6,0	2,0/5,0 /9,0	4,0/11,0 /18,0	2,0/6,0 /13,0	3,0/10,0 /15,0	51/12,0 /16,3	10,3/15,6 /21,5	2,6/2,8 /2,9	9,2/15,6 /18,4	4,0/16,4 /29,3	
<b>Sound levels</b>												
Sound power	dB(A)	42/47/53	44/51/58	45/52/58	46/54/60	47/54/61	46/54/58	46/54/58	46/54/57	47/55/58	48/55/60	
<b>Ventilation</b>												
Number of fans		1	1	2	2	3	1	1	2	2	3	
Air flow	m <sup>3</sup> /h	90/200/290	140/290/390	190/390/550	230/450/680	250/610/870	120/260/390	180/350/560	240/440/730	260/550/905	280/750/1150	
Maximum static pressure	Pa	100	90	120	110	140	90	130	110	140	140	
<b>Electrical data</b>												
Power supply	Voltage	V	230	230	230	230	230	230	230	230	230	
	Phase		Single phase	Single phase	Single phase	Single phase	Single phase	Single phase	Single phase	Single phase	Single phase	
	Frequency	Hz	50	50	50	50	50	50	50	50	50	
Consumption	W	14/32/80	22/55/140	26/65/160	33/80/160	38/115/230	6/11/24	7/14/31	8/16/34	13/30/38	14/42/85	
Degree of protection	IP	X0	X0	X0	X0	X0	X0	X0	X0	X0	X0	
<b>Connections</b>												
Hydraulic connections type		Eurokonus	Eurokonus	Eurokonus	Eurokonus	Eurokonus	Eurokonus	Eurokonus	Eurokonus	Eurokonus	Eurokonus	
Hydraulic connections	Inch	¾	¾	¾	¾	¾	¾	¾	¾	¾	¾	
Condensate drainage connection	mm	20	20	20	20	20	20	20	20	20	20	
Intake air connection (base x height)	mm	460 x 100	660 x 100	860 x 100	1060 x 100	1320 x 100	460 x 150	660 x 150	860 x 150	1060 x 150	1320 x 150	
Return air connection (base x height)	mm	510 x 100	710 x 100	910 x 100	1110 x 100	1370 x 100	510 x 150	710 x 150	910 x 150	1110 x 150	1370 x 150	
<b>Dimension and weight</b>												
Dimension	H x W x D	mm	185 x 590 x 575	185 x 790 x 575	185 x 990 x 575	185 x 1190 x 575	185 x 1440 x 575	240 x 590 x 695	240 x 790 x 695	240 x 990 x 695	240 x 1190 x 695	240 x 1440 x 695
Weight	kg	30	41	45	54	65	32	43	47	56	67	

1) Fan standard factory set speeds. 2) According to Eurovent standard. Air: 27 °C DB/19 °C WB, chilled water: 7 °C/12 °C. 3) Pressure loss by corresponding nominal flow. 4) According to Eurovent standard. Air: 20 °C, hot water: 45 °C/40 °C.

## Configure your own Aquarea Air Smart fan coil ducted thin / ducted unit

Fan coil with wall-mounted control			Fan coil with PCB for analog control (0-10 V)		
Left-hand piping	Right-hand piping		Left-hand piping	Right-hand piping	
P-FTN15005-RE	P-FTN15R05-RE		P-FTN15005-JE	P-FTN15R05-JE	
P-FTN20005-RE	P-FTN20R05-RE		P-FTN20005-JE	P-FTN20R05-JE	
P-FTN25005-RE	P-FTN25R05-RE		P-FTN25005-JE	P-FTN25R05-JE	
P-FTN35005-RE	P-FTN35R05-RE		P-FTN35005-JE	P-FTN35R05-JE	
P-FTN45005-RE	P-FTN45R05-RE		P-FTN45005-JE	P-FTN45R05-JE	
P-FSN20005-RE	P-FSN20R05-RE		P-FSN20005-JE	P-FSN20R05-JE	
P-FSN25005-RE	P-FSN25R05-RE		P-FSN25005-JE	P-FSN25R05-JE	
P-FSN35005-RE	P-FSN35R05-RE		P-FSN35005-JE	P-FSN35R05-JE	
P-FSN45005-RE	P-FSN45R05-RE		P-FSN45005-JE	P-FSN45R05-JE	
P-FSN55005-RE	P-FSN55R05-RE		P-FSN55005-JE	P-FSN55R05-JE	
Control (required, to be ordered separately)	With Modbus	PCZ-EEB749			
	With integrated Wi-Fi	PCZ-EFB749			
<b>Valve kits (optional)</b>					
PCZ-V30361	3 way valve with motor				
PCZ-V20139	2 way valve with motor				

# Aquarea Air Smart fan coil ducted multi zone thin / ducted multi zone

Fan coil ducted units with cooling and heating.

Cooling capacity: 0,5 to 7,6 kW.

Heating capacity: 0,5 to 8,52 kW.



Optional controller.  
Wall-mounted control  
with Modbus.  
PCZ-EEB749



Optional controller.  
Wall-mounted control  
with integrated Wi-Fi.  
PCZ-EFB749



Optional controller.  
PCB for analog control  
(0-10 V).

+ CHECK PAGE 132 FOR A WIDER SELECTION OF ACCESSORIES

## The range at a glance

- Multi zone management (2-5 zones)
- Slim profile, only 185 mm for the thin version
- DC Inverter – maximising comfort and energy savings
- Modulated air flow
- Quiet operation
- Centrifugal fan with single motor impeller

## Possible configurations

- Left or right water connections
- 2 or 3 way valves as accessories
- Wall-mounted control or PCB for analog input (0-10 V)

## The ducted Smart fan coil unit with integrated multi zone management.

### High installation flexibility.

#### Single air outlet per zone.



Example:  
3 air outlets for 3 independent zones.

#### Multiple air outlets per zone.



Example:  
3 air outlets for 2 independent zones.  
Zone 1 with dual channel.  
Zone 2 with single channel.

## Multi zone management

Thanks to integrated multi zone management and the use of forward-bladed centrifugal brushless EC multi-fans, the fan coil ducted multi zone allow independent management of the different thermal zones, resulting in benefits in terms of efficiency, comfort and quietness.



### 1 | Air supply plate.

Built-in air supply plate, number of outlets depending on unit size.

- P-FTQ30/P-FSQ30: 2 outlets DN 160 mm
- P-FTQ45/P-FSQ45: 3 outlets DN 160 mm
- P-FTQ60/P-FSQ60: 4 outlets DN 160 mm
- P-FTQ65/P-FSQ75: 5 outlets DN 160 mm

### 2 | Fans.

Integrated multi-fans for independent management of the different zones.

### 3 | Horizontal condensate tray.

Allows the collection of condensate if the unit is installed horizontally.

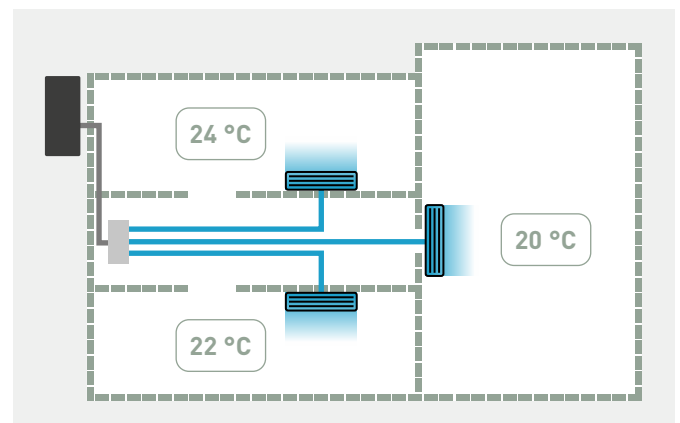



## Technical features

		Ducted multi zone thin				Ducted multi zone				
Model		P-FTQ30	P-FTQ45	P-FTQ60	P-FTQ65	P-FSQ30	P-FSQ45	P-FSQ60	P-FSQ75	
<small>(the complete model codes are shown in the table below)</small>										
Fan speed <sup>1)</sup>		Min / Med / Max	Min / Med / Max	Min / Med / Max	Min / Med / Max	Min / Med / Max	Min / Med / Max	Min / Med / Max	Min / Med / Max	
Total cooling capacity <sup>2)</sup>	kW	1,10/1,97 /3,02	1,16/2,97 /4,40	2,02/3,68 /5,70	2,09/4,15 /6,40	0,47/3,80 /3,23	0,66/3,77 /4,57	0,85/4,87 /5,88	1,06/6,31 /7,61	
Sensible capacity <sup>2)</sup>	kW	0,76 /1,37 /2,15	0,79/2,09 /3,16	1,45/2,67 /4,10	1,61/3,08 /4,60	0,33/2,70 /2,22	0,48/2,62 /3,16	0,63/3,40 /4,10	0,78/4,32 /5,20	
Single zone cooling capacity <sup>2)</sup>	kW	0,49/1,30 /1,70	0,49/1,30 /1,70	0,49/1,30 /1,70	0,49/1,30 /1,70	-/-/2,10	-/-/2,10	-/-/2,10	-/-/2,10	
Single zone sensible capacity <sup>2)</sup>	kW	0,31/0,89 /1,23	0,31/0,89 /1,23	0,31/0,89 /1,23	0,31/0,89 /1,23	-/-/1,50	-/-/1,50	-/-/1,50	-/-/1,50	
Water flow <sup>2)</sup>	l/h	190/338 /530	200/510 /800	346/630 /1030	358/713 /1220	80/651 /553	113/647 /782	146/834 /1008	182,3/1081 /1304	
Water pressure drop <sup>2)3)</sup>	kPa	4,0/11,0/22,0	2,0/9,0/18,0	3,0/9,0/18,0	1,0/4,0/9,0	1,8/29,0/54,1	1,2/25,7/36,4	1,0/20,2/28,5	1,6/37,3/52,6	
Heating capacity <sup>4)</sup>	kW	1,15/2,11 /3,30	1,71/3,19 /4,90	-/5,76/6,30	2,67/4,75 /7,65	0,45/3,90 /3,61	0,68/4,16 /5,08	0,90/5,42 /6,59	1,13/6,87 /8,37	
Single zone heating capacity <sup>4)</sup>	kW	0,42/1,29 /1,85	0,42/1,29 /1,85	0,42/1,29 /1,85	0,42/1,29 /1,85	-/-/2,20	-/-/2,20	-/-/2,20	-/-/2,20	
Water flow <sup>4)</sup>	l/h	200/368 /560	296/554 /800	391/699 /1110	464/826 /1305	80/688 /636	120/748 /914	159/975 /1189	199/1230 /1502	
Water pressure drop <sup>3)4)</sup>	kPa	4,0/13,0/25,0	3,0/10,0/19,0	3,0/10,0/18,0	2,0/5,0/10,0	1,4/29,0/61,2	1,1/28,9/42,3	0,9/23,1/33,7	1,5/41,4/60,6	
<b>Sound levels</b>										
Sound power	dB(A)	40/49/58	42/50/59	42/52/61	43/53/62	-/-/60	-/-/61	-/-/62	-/-/64	
<b>Ventilation</b>										
Number of fans		2	3	4	5	2	3	4	5	
Air flow	m <sup>3</sup> /h	145/290 /480	215/435 /720	288/576 /960	360/720 /1200	60/600 /810	90/900 /1215	120/1200 /1620	150/1500 /2025	
Single zone air flow	m <sup>3</sup> /h	50/160/240	50/160/240	50/160/240	50/160/240	60/205/300	60/205/300	60/205/300	60/205/300	
Maximum static pressure	Pa	100	100	100	100	100	100	100	100	
<b>Electrical data</b>										
Power supply	Voltage	V	230	230	230	230	230	230	230	
	Phase		Single phase	Single phase	Single phase	Single phase	Single phase	Single phase	Single phase	
	Frequency	Hz	50	50	50	50	50	50	50	
Consumption	W	31/66/130	45/102/195	61/135/260	76/162/325	53/140/178	159/420/534	212/560/712	265/700/890	
Degree of protection	IP	X0	X0	X0	X0	X0	X0	X0	X0	
<b>Connections</b>										
Hydraulic connections type		Eurokonus	Eurokonus	Eurokonus	Eurokonus	Eurokonus	Eurokonus	Eurokonus	Eurokonus	
Hydraulic connections	Inch	¾	¾	¾	¾	¾	¾	¾	¾	
Condensate drainage connection	mm	20	20	20	20	20	20	20	20	
Intake air connection (base x height)	mm	160	160	160	160	160	160	160	160	
Return air connection (base x height)	mm	630 x 100	830 x 100	1030 x 100	1320 x 100	630 x 150	830 x 150	1030 x 150	1320 x 150	
<b>Dimension and weight</b>										
Dimension	H x W x D	mm	185 x 790 x 575	185 x 990 x 575	185 x 1190 x 575	185 x 1440 x 575	240 x 790 x 695	240 x 990 x 695	240 x 1190 x 695	240 x 1440 x 695
Weight	kg	41	45	54	56	43	47	56	67	

1) Fan standard factory set speeds. 2) According to Eurovent standard. Air: 27 °C DB/19 °C WB, chilled water: 7 °C/12 °C. 3) Pressure loss by corresponding nominal flow. 4) According to Eurovent standard. Air: 20 °C, hot water: 45 °C/40 °C.

## Configure your own Aquarea Air Smart fan coil ducted multi zone thin / ducted multi zone unit

Fan coil with wall-mounted control			Fan coil with PCB for analog control (0-10 V)		
Left-hand piping	Right-hand piping		Left-hand piping	Right-hand piping	
P-FTQ30005-RE	P-FTQ30R05-RE		P-FTQ30005-JE	P-FTQ30R05-JE	
P-FTQ45005-RE	P-FTQ45R05-RE		P-FTQ45005-JE	P-FTQ45R05-JE	
P-FTQ60005-RE	P-FTQ60R05-RE		P-FTQ60005-JE	P-FTQ60R05-JE	
P-FTQ65005-RE	P-FTQ65R05-RE		P-FTQ65005-JE	P-FTQ65R05-JE	
P-FSQ30005-RE	P-FSQ30R05-RE		P-FSQ30005-JE	P-FSQ30R05-JE	
P-FSQ45005-RE	P-FSQ45R05-RE		P-FSQ45005-JE	P-FSQ45R05-JE	
P-FSQ60005-RE	P-FSQ60R05-RE		P-FSQ60005-JE	P-FSQ60R05-JE	
P-FSQ75005-RE	P-FSQ75R05-RE		P-FSQ75005-JE	P-FSQ75R05-JE	
Control (required, to be ordered separately)	With Modbus	PCZ-EEB749			
	With integrated Wi-Fi	PCZ-EFB749			
<b>Valve kits (optional)</b>					
PCZ-V30361	3 way valve with motor				
PCZ-V20139	2 way valve with motor				

# Fan coil comfort AC fan

Fan coil floor and ceiling units with cooling and heating.

**Cooling capacity: 0,6 to 6,9 kW.**

**Heating capacity: 0,6 to 7,4 kW.**



Optional controller.  
WRC remote control.



Optional controller.  
SRC - mini BMS  
controller.



Optional controller.  
Electronic controller  
TControl POD glass.



Optional controller.  
Electronic controller  
TControl EASY 3S.



Optional controller.  
Wired remote  
controller with  
touch control.  
PAW-FC-907AC



Optional controller.  
Wired remote  
controller.  
PAW-FC-903AC



Optional controller.  
Advanced wired  
remote controller.  
PAW-FC-RC1

## Operating limits

Entering water temperature (without glycol).

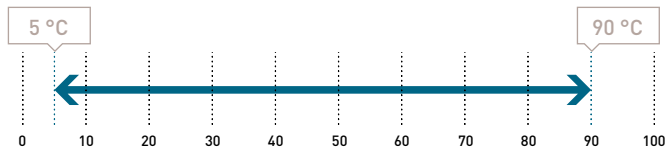

Indoor air temperature.

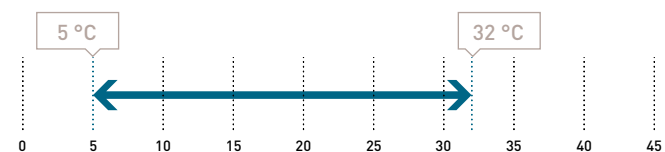

## The range at a glance

- Versions: 2-pipes, 2-pipes + electric heater and 4-pipes
- 7 sizes
- 5-speed AC fan - standard factory set speeds: S1,S3,S5
- Air flow from 94 to 1064 m<sup>3</sup>/h
- Configuration: universal installation units (vertical or horizontal) with or without cabinet
- Left or right water connections
- Many air inlet/outlet configurations
- G2 air filter (G3 as an option)

## Advantages

- Silent units
- New casing design for an increased robustness
- Harmonious and aesthetic RAL 9003 painted cabinet
- Valves, condensate drain pan and drain pump factory mounted
- 100% factory tested

## Accessories and options

- 2 way or 3 way valves
- 4-pipes kit (additional coil)
- Circuit breakers
- Drain pump
- Electric heaters (from 500 W to 2500 W)
- Feet with/without grid
- Fuse holders
- G3 filter
- Horizontal or vertical drain guard (with valve)
- Many air inlet/outlet configurations
- Mechanical sensor for automatic change over
- Modbus communication board for Plogic
- MRC/WRC/BRC: remote controls for Plogic
- Other speeds configuration (standard factory set speeds: S1,S3,S5)
- SRC - mini BMS controller
- Suspension kit
- Plogic controller (other electromechanical or electronic control systems also available)
- TControl EASY 3S and TControl POD glass controllers (other electromechanical or electronic control systems also available)

+ SEE PAGE 580 FOR MORE DETAILS ABOUT FAN COIL CONTROLLERS

## AC SELECT.

Smart and user-friendly the new air conditioning selection program: <https://acselect.panasonic.eu/>



Technical features

Fan coil comfort AC fan		P-FC10		P-FC20		P-FC30		P-FC40		P-FC50		P-FC60		P-FC70		
		S1/S3/S5 <sup>1)</sup>		S1/S3/S5 <sup>1)</sup>		S1/S3/S5 <sup>1)</sup>		S1/S3/S5 <sup>1)</sup>		S1/S3/S5 <sup>1)</sup>		S1/S3/S5 <sup>1)</sup>		S1/S3/S5 <sup>1)</sup>		
<b>2-pipes</b>																
Total cooling capacity <sup>2)</sup>	kW	0,66/1,00/1,45	0,61/0,96/1,38	0,95/1,88/2,37	1,14/2,28/3,02	1,71/3,16/4,64	2,57/4,33/5,53	3,24/5,84/6,91								
Sensible capacity <sup>2)</sup>	kW	0,48/0,77/1,05	0,43/0,70/1,02	0,78/1,44/1,80	0,83/1,66/2,23	1,24/2,23/3,27	1,81/3,14/4,25	2,26/4,11/4,85								
Water flow <sup>2)</sup>	l/h	114/172/250	105/165/238	164/324/408	196/393/520	295/544/799	443/746/953	558/1006/1190								
Water pressure drop <sup>2) 3)</sup>	kPa	9,17/19,5/39,1	2,65/4,62/7,43	5,8/17,6/26,3	5,0/15,6/25,6	7,5/22,8/47,1	12,6/33,9/54,4	4,4/13,9/19,4								
Heating capacity <sup>4)</sup>	kW	0,63/1,18/1,71	0,63/1,03/1,53	1,00/1,86/2,49	1,14/2,28/3,18	1,79/3,47/4,81	2,45/4,22/5,63	3,45/6,27/7,41								
Water flow <sup>4)</sup>	l/h	109/203/295	109/177/264	172/320/429	196/393/548	308/598/829	422/727/970	594/1080/1276								
Water pressure drop <sup>2) 4)</sup>	kPa	5,9/17,3/33,8	2,76/5,06/8,54	5,8/16,2/27,0	5,0/15,6/28,1	6,1/20,7/38,5	18,6/52,4/91,4	4,9/16,0/22,3								
<b>4-pipes</b>																
Total cooling capacity <sup>2)</sup>	kW	0,63/0,88/1,24	0,87/1,34/1,73	0,91/1,80/2,28	0,98/2,14/2,85	1,57/2,88/4,13	2,60/4,39/5,61	3,17/5,62/6,58								
Sensible capacity <sup>2)</sup>	kW	0,46/0,67/0,91	0,65/1,02/1,36	0,75/1,39/1,74	0,71/1,57/2,10	1,14/2,04/2,92	1,82/3,18/4,28	2,21/3,96/4,62								
Water flow <sup>2)</sup>	l/h	109/152/214	150/231/298	157/310/393	169/369/491	270/496/711	448/756/966	546/968/1133								
Water pressure drop <sup>2) 3)</sup>	kPa	7,6/13,9/26,3	2,33/4,44/6,64	2,8/8,6/13,1	5,8/20,5/33,6	3,9/11,6/22,8	10,2/27,7/44,5	5,3/16,2/22,1								
Heating capacity <sup>5)</sup>	kW	0,63/1,00/1,41	1,00/1,40/1,68	1,28/1,81/2,13	1,22/2,21/2,85	2,01/3,19/4,08	2,71/4,24/5,33	3,65/5,00/5,90								
Water flow <sup>5)</sup>	l/h	54/86/121	86,1/121/145	110/156/183	105/190/245	173/275/351	233/365/459	314/431/508								
Water pressure drop <sup>2) 5)</sup>	kPa	1,2/2,1/3,3	1,15/2,2/3,12	2,8/4,7/6,1	5,1/13,9/21,8	5,7/12,5/19,4	11,6/24,8/37	35,4/60,7/81,2								
<b>Sound levels</b>																
Sound power	2-pipes	dB(A)	33/40/49	31/43/50	30/45/52	30/44/51	34/43/56	38/51/58	43/56/61							
	4-pipes	dB(A)	33/40/49	31/43/50	30/45/52	30/44/51	34/46/56	38/51/58	43/56/61							
Sound pressure <sup>6)</sup>	2-pipes	dB(A)	24/31/40	22/34/41	21/36/43	21/35/42	25/37/47	29/42/49	34/47/52							
	4-pipes	dB(A)	24/31/40	22/34/41	21/36/43	21/35/42	25/37/47	29/42/49	34/47/52							
NR <sup>6)</sup>	2-pipes		19/26/35	17/29/36	16/31/38	16/30/37	20/32/42	24/37/44	29/42/47							
	4-pipes		19/26/35	17/29/36	16/31/38	16/30/37	20/32/42	24/37/44	29/42/47							
<b>Ventilation</b>																
Number of fans			1	1	1	2	2	2	2							
Air flow	2-pipes	m <sup>3</sup> /h	94/190/283	68/104/196	138/274/390	173/357/499	253/486/716	350/640/933	480/893/1064							
	4-pipes	m <sup>3</sup> /h	95/168/253	89/161/241	132/263/369	148/335/467	242/466/671	334/614/885	470/859/1012							
Filter			G2	G2	G2	G2	G2	G2	G2							
<b>Electrical data</b>																
Power supply	Voltage	V	230	230	230	230	230	230	230							
	Phase		Single phase	Single phase	Single phase	Single phase	Single phase	Single phase	Single phase							
	Frequency	Hz	50/60	50/60	50/60	50/60	50/60	50/60	50/60	50/60						
Consumption	2-pipes	W	13/24/36	13/18/31	16/37/45	15/37/56	28/55/72	37/75/105	53/100/147							
	4-pipes	W	13/24/36	11/18/28	16/37/44	15/37/55	28/54/70	37/74/104	53/99/145							
Electric heater	W	500	500	500/1000	1250	1250/2500	1250/2500	1250/2500								
<b>Water connections</b>																
Connection type			Female gas threaded	Female gas threaded	Female gas threaded	Female gas threaded	Female gas threaded	Female gas threaded	Female gas threaded							
2 or 4-pipes	Cooling	Inch	½	½	½	½	½	½	½							
4-pipes	Heating	Inch	½	½	½	½	½	½	½							
<b>Dimension</b>																
With cabinet - without feet	H x W x D	mm	477 x 766 x 225	477 x 766 x 225	477 x 951 x 225	477 x 1136 x 225	477 x 1321 x 225	477 x 1506 x 225	575 x 1319 x 225							
Without cabinet	H x W x D	mm	430 x 570 x 220	430 x 570 x 220	430 x 753 x 220	430 x 938 x 220	430 x 1122 x 220	430 x 1307 x 220	530 x 1121 x 220							
<b>Weight</b>																
With cabinet	2-pipes	kg	19	19	22	27	30	35	35							
	4-pipes	kg	20	20	23	29	32	37	37							
Without cabinet	2-pipes	kg	13	13	15	20	22	26	27							
	4-pipes	kg	14	14	16	22	24	28	29							

Energy efficiency class<sup>7)</sup>

Fan coil comfort AC fan		FCEER	A to E	E	E	D	D	D	D	D
2-pipes	FCCOP	A to E	E	E	E	E	E	E	E	E
	FCEER	A to E	E	D	D	D	E	D	D	D
4-pipes	FCCOP	A to E	E	D	D	D	E	E	E	E
	FCEER	A to E	E	D	D	D	E	D	D	D

1) Fan standard factory set speeds. 2) According to Eurovent standard. Air: 27 °C DB/19 °C WB, chilled water: 7 °C/12 °C. 3) Pressure loss by corresponding nominal flow. 4) According to Eurovent standard. Air: 20 °C, hot water: 45 °C/40 °C. 5) According to Eurovent standard. Air: 20 °C, hot water: 65 °C/55 °C. 6) Informative data, considering an hypothetical sound attenuation of the room and installation of 9 dB(A). 7) According to Eurovent. \* Standard configuration with left hand hydraulic connection. G2 air filter included as standard.



ErP compliant following COMMISSION REGULATION (EU) 2016/2281.



# Fan coil comfort EC fan

Fan coil floor and ceiling units with cooling and heating.

**Cooling capacity: 0,5 to 9,1 kW.**

**Heating capacity: 0,6 to 12,9 kW.**



Optional controller.  
WRC remote control.



Optional controller.  
SRC - mini BMS  
controller.



Optional controller.  
Electronic controller  
TControl POD glass.



Optional controller.  
Electronic controller  
TControl EASY 3S.



Optional controller.  
Wired remote controller  
with touch control.  
PAW-FC-907EC



Optional controller.  
Wired remote controller.  
PAW-FC-903EC

## Operating limits

Entering water temperature (without glycol).

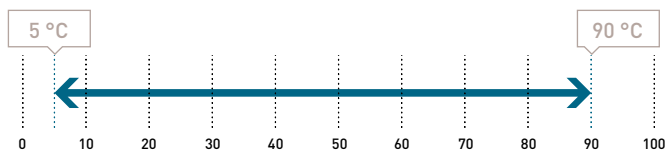

Indoor air temperature.

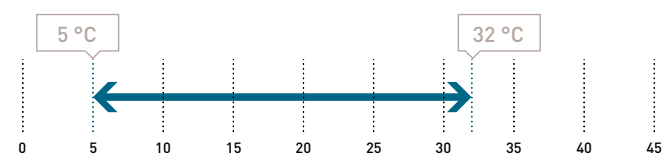

## The range at a glance

- Versions: 2-pipes, 2-pipes + electric heater and 4-pipes
- 8 sizes
- Low energy consumption EC fan: 100% controllable via a 0-10 V signal or 3 operating speeds
- Air flow from 91 to 1548 m<sup>3</sup>/h
- Configuration: universal installation units (vertical or horizontal) with or without cabinet
- Left or right water connections
- Many air inlet/outlet configurations
- G2 air filter (G3 as an accessory)

## Advantages

- Excellent performances: FCEER and FCCOP up to "A"
- Silent units
- New casing design for an increased robustness
- Harmonious and aesthetic RAL 9003 painted cabinet
- Valves, condensate drain pan and drain pump factory mounted
- 100% factory tested

## Accessories and options

- 2 way or 3 way valves
- 4-pipes kit (additional coil)
- Circuit breakers
- Drain pump
- Ecospeed card for EC fans
- Electric heaters (from 500 W to 2500 W)
- Feet with/without grid
- Fuse holders
- G3 filter
- Horizontal or vertical drain guard (with valve)
- Many air inlet/outlet configurations
- Electromechanical sensor for automatic change over
- Modbus communication board for Plologic
- MRC/WRC/BRC: remote controls for Plologic
- Other speeds configuration (standard factory set speeds in technical features table)
- SRC - mini BMS controller
- Suspension kit
- Plologic controller (other electromechanical or electronic control systems also available)
- TControl EASY 3S and TControl POD glass controllers (other electromechanical or electronic control systems also available)

+ SEE PAGE 580 FOR MORE DETAILS ABOUT FAN COIL CONTROLLERS

## AC SELECT.

Smart and user-friendly the new air conditioning selection program: <https://acselect.panasonic.eu/>



## Technical features

Fan coil comfort EC fan			P-FC10	P-FC20	P-FC30	P-FC40	P-FC50	P-FC60	P-FC70	P-FC80
			2V/5V/10V <sup>1)</sup>	2V/5V/10V <sup>1)</sup>	2V/6V/10V <sup>1)</sup>	2V/5V/10V <sup>1)</sup>	2V/7V/10V <sup>1)</sup>	2V/7V/10V <sup>1)</sup>	4V/8V/10V <sup>1)</sup>	3V/4,1V/6,4V <sup>1)</sup>
<b>2-pipes</b>										
Total cooling capacity <sup>2)</sup>	kW		0,59/1,16/1,96	0,61/1,31/2,12	0,67/1,41/1,83	1,34/2,93/4,19	1,34/3,57/4,98	1,98/4,45/5,24	2,55/5,56/6,55	4,59/6,13/8,36
Sensible capacity <sup>2)</sup>	kW		0,48/1,00/1,76	0,47/1,06/1,72	0,47/1,04/1,34	0,95/2,10/3,00	1,05/2,70/3,70	1,35/3,51/4,02	1,91/4,10/4,96	3,32/4,51/6,28
Water flow <sup>2)</sup>	l/h		102/200/338	105/226/365	141/336/505	231/505/722	231/615/858	341/767/903	439/958/1128	791/1056/1440
Water pressure drop <sup>2) 3)</sup>	kPa		7,5/25,7/69,5	1,4/4,3/9,3	5,9/21,8/42,9	6,4/24,3/46,3	4,9/28,7/53,9	7,8/35,8/49,0	2,7/12,6/17,5	14,1/21,4/37,6
Heating capacity <sup>4)</sup>	kW		0,67/1,30/2,31	0,68/1,53/2,52	0,80/1,72/2,66	1,11/2,48/4,46	1,38/3,89/5,19	1,95/4,93/5,82	3,05/5,81/7,17	4,21/5,80/8,43
Water flow <sup>4)</sup>	l/h		115/224/398	117/264/434	138/296/458	191/427/768	238/670/894	336/849/1002	525/1001/1235	798/1101/1598
Water pressure drop <sup>2) 4)</sup>	kPa		6,5/20,6/59,1	1,7/5,5/12,4	4,1/14,2/30,4	4,8/18,1/51,9	3,8/25,7/44,6	12,2/70,7/97,5	3,9/13,8/20,9	14,4/23,1/45,6
<b>4-pipes</b>										
Total cooling capacity <sup>2)</sup>	kW		0,51/1,02/1,80	0,57/1,20/2,18	0,75/1,84/2,93	1,03/2,20/3,52	1,17/3,45/4,39	1,69/3,90/4,69	2,44/4,88/6,06	4,44/5,86/9,07
Sensible capacity <sup>2)</sup>	kW		0,41/0,87/1,60	0,43/0,96/1,76	0,55/1,44/2,28	0,73/1,57/2,58	0,92/2,61/3,28	1,12/3,05/3,63	1,83/3,61/4,53	3,20/4,31/6,84
Water flow <sup>2)</sup>	l/h		87,8/176/310	98,2/207/376	129/317/505	177/379/606	202/594/756	291/672/808	420/841/1044	765/1009/1562
Water pressure drop <sup>2) 3)</sup>	kPa		5,2/18,3/53,4	1,3/3,8/9,7	4,0/13,7/28,0	9,3/27,8/58,9	2,3/16,2/25,6	4,6/22,0/31,4	3,2/12,3/18,8	18,8/30,6/67,2
Heating capacity <sup>5)</sup>	kW		0,61/1,13/1,87	0,79/1,33/2,09	1,41/2,01/2,77	1,57/2,49/3,62	2,18/3,34/4,10	1,81/4,05/4,81	3,45/4,67/5,53	5,74/7,99/12,90
Water flow <sup>5)</sup>	l/h		52,5/97,3/161	68/115/180	121/173/239	135/214/312	188/288/353	156/349/414	297/402/476	494/688/1111
Water pressure drop <sup>2) 5)</sup>	kPa		1,1/2,4/4,8	<1/2,0/4,8	7,9/12,3/18,6	10,9/22,2/41,1	6,5/13,6/19,6	16,1/45,3/57,5	32,2/53,9/72,4	19,2/34,5/83,1
<b>Sound levels</b>										
Sound power	2-pipes	dB(A)	34/47/60	34/47/60	31/50/59	29/44/52	30/51/57	32/54/58	40/54/59	51/56/64
	4-pipes	dB(A)	34/47/60	34/47/60	31/50/59	29/44/56	30/51/57	32/54/58	40/54/59	51/56/64
Sound pressure <sup>6)</sup>	2-pipes	dB(A)	25/38/51	25/38/51	22/41/50	20/35/43	21/42/48	23/45/49	31/45/50	42/47/55
	4-pipes	dB(A)	25/38/51	25/38/51	22/41/50	20/35/43	21/42/48	23/45/49	31/45/50	42/47/55
NR <sup>6)</sup>	2-pipes		20/33/46	20/33/46	17/36/45	15/30/38	16/37/43	18/40/44	26/40/45	37/42/50
	4-pipes		20/33/46	20/33/46	17/36/45	15/30/38	16/37/43	18/40/44	26/40/45	37/42/50
<b>Ventilation</b>										
Number of fans			1	1	1	2	2	2	2	3
Air flow	2-pipes	m <sup>3</sup> /h	108/228/417	98/234/413	119/257/345	170/412/678	203/577/816	245/737/912	350/850/1050	500/680/1063
	4-pipes	m <sup>3</sup> /h	91/199/379	84/200/380	123/297/540	148/298/524	185/587/755	205/668/845	329/798/989	660/884/1548
Filter			G2	G2	G2	G2	G2	G2	G2	G2
<b>Electrical data</b>										
Power supply	Voltage	V	230	230	230	230	230	230	230	230
	Phase		Single phase	Single phase	Single phase	Single phase	Single phase	Single phase	Single phase	Single phase
	Frequency	Hz	50/60	50/60	50/60	50/60	50/60	50/60	50/60	50/60
Consumption	2-pipes	W	7/12/41	7/13/41	6/16/42	2/13/43	4/23/46	4/30/54	11/44/77	23/42/108
	4-pipes	W	7/12/39	7/13/40	6/14/40	2/11/39	4/23/44	4/28/52	11/43/75	22/41/116
Electric heater	W		500	500	500/1000	1250	1250/2500	1250/2500	1250/2500	1250/2500
<b>Water connections</b>										
Connection type			Female gas threaded	Female gas threaded	Female gas threaded	Female gas threaded	Female gas threaded	Female gas threaded	Female gas threaded	Female gas threaded
2 or 4-pipes	Cooling	Inch	½	½	½	½	½	½	¾	¾
4-pipes	Heating	Inch	½	½	½	½	½	½	½	½
<b>Dimension</b>										
With cabinet - without feet	H x W x D	mm	477 x 766 x 225	477 x 766 x 225	477 x 951 x 225	477 x 1136 x 225	477 x 1321 x 225	477 x 1506 x 225	575 x 1319 x 225	575 x 1506 x 225
Without cabinet	H x W x D	mm	430 x 570 x 220	430 x 570 x 220	430 x 753 x 220	430 x 938 x 220	430 x 1122 x 220	430 x 1307 x 220	530 x 1121 x 220	530 x 1316 x 220
<b>Weight</b>										
With cabinet	2-pipes	kg	19	19	22	27	30	35	35	47
	4-pipes	kg	20	20	23	29	32	37	37	49
Without cabinet	2-pipes	kg	13	13	15	20	22	26	27	38
	4-pipes	kg	14	14	16	22	24	28	29	40

Energy efficiency class<sup>7)</sup>

Fan coil comfort EC fan										
2-pipes	FCEER	A to E	C	C	B	A	A	A	B	B
	FCCOP	A to E	D	C	C	B	A	B	B	C
4-pipes	FCEER	A to E	C	C	B	A	B	B	B	A
	FCCOP	A to E	C	C	B	A	B	B	B	A

1) Fan standard factory set speeds (voltage). 2) According to Eurovent standard. Air: 27 °C DB/19 °C WB, chilled water: 7 °C/12 °C. 3) Pressure loss by corresponding nominal flow. 4) According to Eurovent standard. Air: 20 °C, hot water: 45 °C/40 °C. 5) According to Eurovent standard. Air: 20 °C, hot water: 65 °C/55 °C. 6) Informative data, considering a hypothetical sound attenuation of the room and installation of 9 dB(A). 7) According to Eurovent. \* Standard configuration with left hand hydraulic connection. G2 air filter included as standard.



ErP compliant following COMMISSION REGULATION (EU) 2016/2281.



# Fan coil cassette AC fan

Fan coil cassette units with cooling and heating.

**Cooling capacity: 1,3 to 8,6 kW.**

**Heating capacity: 1,1 to 12,8 kW.**



Optional controller. WRC remote control.



Optional controller. SRC - mini BMS controller.



Optional controller. Electronic controller TControl POD glass.



Optional controller. Electronic controller TControl EASY 3S.



Optional controller. Wired remote controller with touch control. PAW-FC-907AC



Optional controller. Wired remote controller. PAW-FC-903AC



Optional controller. Advanced wired remote controller. PAW-FC-RC1

## Operating limits

Entering water temperature (without glycol).

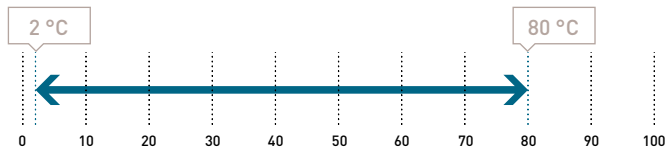

Indoor air temperature.

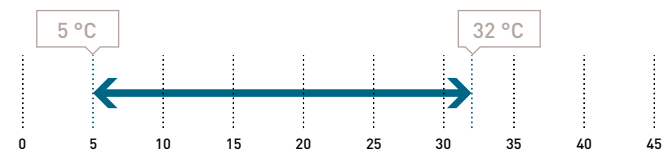

## The range at a glance

- Versions: 2-pipes, 2-pipes + electric heater and 4-pipes
- 6 sizes
- 3-speed AC fan
- Air flow from 360 to 1447 m<sup>3</sup>/h
- Integrated condensate drain pump
- G1 cleanable air filter

## Advantages

- Aesthetic and IRYS COANDA design diffusers with strong coanda effect
- Silent units
- Easy installation and maintenance: all connections on the same side. Electrical box and valves outside of the unit
- Low built-in-height
- Perfect integration into standard 600 x 600 ceiling tiles\*
- Valves and drain pump factory mounted

\* From 20 to 40 with IRYS COANDA diffusers.

## IRYS COANDA diffusers.

For a unique design and a strong coanda effect.



**IRYS COANDA 360.**  
360° air diffusion.



**IRYS COANDA 180.**  
180° air diffusion.

Coanda effect measurements taken in our Panasonic development center.

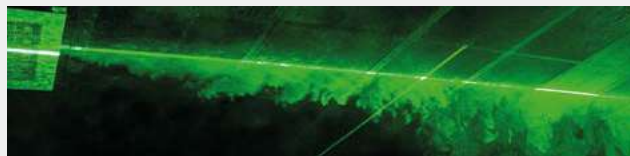

+ SEE PAGE 580 FOR MORE DETAILS ABOUT FAN COIL CONTROLLERS

## AC SELECT.

Smart and user-friendly the new air conditioning selection program: <https://acselect.panasonic.eu/>



Technical features

Fan coil cassette AC fan			P-FQ20	P-FQ30	P-FQ40	P-FQ50	P-FQ60	P-FQ70
			S2/S3/S4 <sup>1)</sup>	S2/S3/S4 <sup>1)</sup>	S2/S3/S4 <sup>1)</sup>	S2/S3/S4 <sup>1)</sup>	S2/S3/S4 <sup>1)</sup>	S2/S3/S4 <sup>1)</sup>
<b>2-pipes</b>								
Total cooling capacity <sup>2)</sup>	kW		1,54/1,76/2,36	1,87/2,87/3,99	2,78/3,49/4,69	3,35/4,43/6,07	3,69/5,46/7,18	4,04/6,48/8,61
Sensible capacity <sup>2)</sup>	kW		1,29/1,48/1,98	1,41/2,17/3,04	2,08/2,67/3,62	2,52/3,35/4,47	2,67/4,06/5,42	2,97/4,85/6,34
Water flow <sup>2)</sup>	l/h		265/303/404	323/493/683	478/597/801	576/762/1042	636/937/1233	695/1111/1476
Water pressure drop <sup>2)</sup>	kPa		4,0/5,0/10,0	3,0/7,0/14,0	6,0/10,0/18,0	7,0/12,0/22,0	3,0/6,0/11,0	5,0/12,0/20,0
Heating capacity <sup>3)</sup>	kW		1,92/2,17/2,74	1,94/3,15/3,68	3,16/3,92/5,28	3,80/5,08/6,84	3,85/6,26/8,51	4,38/7,95/10,28
Water flow <sup>3)</sup>	l/h		331/374/472	334/543/634	544/675/909	655/875/1178	663/1078/1466	754/1369/1771
Water pressure drop <sup>3)</sup>	kPa		6,0/7,0/10,0	3,0/9,0/11,0	7,0/10,0/17,0	8,0/13,0/22,0	3,0/8,0/14,0	6,0/17,0/26,0
<b>4-pipes</b>								
Total cooling capacity <sup>2)</sup>	kW		1,29/1,48/1,97	1,99/2,68/3,37	2,55/3,21/4,00	—	2,97/4,96/6,63	3,17/6,01/7,55
Sensible capacity <sup>2)</sup>	kW		1,18/1,38/1,84	1,49/2,07/2,65	2,03/2,58/3,30	—	2,23/3,77/5,06	2,38/4,68/5,95
Water flow <sup>2)</sup>	l/h		232/258/359	342/465/576	437/563/683	—	511/851/1137	543/1030/1294
Water pressure drop <sup>2)</sup>	kPa		6,0/8,0/13,0	4,0/7,0/11,0	6,0/10,0/15,0	—	5,0/14,0/24,0	6,0/20,0/30,0
Heating capacity <sup>4)</sup>	kW		1,09/1,27/1,67	3,10/4,40/5,46	4,32/5,00/5,80	—	5,28/7,79/10,04	6,43/10,07/12,77
Water flow <sup>4)</sup>	l/h		94/109/144	267/379/470	372/431/500	—	455/671/865	554/867/1100
Water pressure drop <sup>4)</sup>	kPa		15,0/17,0/28,0	7,0/13,0/20,0	13,0/17,0/23,0	—	4,0/7,0/11,0	5,0/11,0/16,0
<b>Sound levels</b>								
Sound power	2-pipes	dB(A)	38/42/49	35/47/53	42/48/57	35/40/49	38/46/54	40/52/59
	4-pipes	dB(A)	37/41/49	35/47/53	42/48/57	—	38/46/54	40/52/59
Sound pressure <sup>5)</sup>	2-pipes	dB(A)	27/31/40	26/35/44	33/39/48	26/31/40	29/37/45	31/43/50
	4-pipes	dB(A)	27/31/40	26/35/44	33/39/48	—	29/37/45	31/43/50
NR <sup>5)</sup>	2-pipes		23/27/35	20/30/39	28/34/43	21/26/35	22/32/40	25/38/50
	4-pipes		23/27/35	20/30/39	28/34/43	—	22/32/40	25/38/45
<b>Ventilation</b>								
Number of fans			1	1	1	1	1	1
Air flow	m <sup>3</sup> /h		360/450/659	320/504/734	486/626/900	529/720/979	500/824/1159	601/1080/1447
Filter			G1	G1	G1	G1	G1	G1
<b>Electrical data</b>								
Power supply	Voltage	V	230	230	230	230	230	230
	Phase		Single phase	Single phase	Single phase	Single phase	Single phase	Single phase
	Frequency	Hz	50/60	50/60	50/60	50/60	50/60	50/60
Consumption	2-pipes	W	25/35/58	17/34/58	38/58/99	28/41/66	34/61/88	44/92/125
	4-pipes	W	25/35/58	17/34/58	38/58/99	—	34/61/88	44/92/125
Electric heater	W		1500	2500	2500	2x1500	2x1500	2x1500
<b>Water connections</b>								
Connection type			Female gas threaded	Female gas threaded	Female gas threaded	Female gas threaded	Female gas threaded	Female gas threaded
2 or 4-pipes	Cooling	Inch	¾	¾	¾	1	1	1
4-pipes	Heating	Inch	½	½	½	—	¾	¾
<b>Dimension</b>								
With plastic diffuser	H x W x D	mm	334 x 720 x 720	334 x 720 x 720	334 x 720 x 720	339 x 960 x 960	339 x 960 x 960	339 x 960 x 960
With IRYS COANDA 180	H x W x D	mm	353 x 595 x 595	353 x 595 x 595	353 x 595 x 595	366 x 849 x 849	366 x 849 x 849	366 x 849 x 849
With IRYS COANDA 360	H x W x D	mm	341 x 595 x 595	341 x 595 x 595	341 x 595 x 595	358 x 849 x 849	358 x 849 x 849	358 x 849 x 849
<b>Weight</b>								
Weight	kg		14,8	16,5	16,5	37,1	37,1	39,6

Energy efficiency class <sup>6)</sup>

Fan coil cassette AC fan								
2-pipes	FCEER	A to E	D	C	D	C	C	C
	FCCOP	A to E	E	D	D	C	C	D
4-pipes	FCEER	A to E	E	C	D	—	C	D
	FCCOP	A to E	E	C	D	—	C	C

1) Fan speeds. 2) According to Eurovent standard. Air: 27 °C DB/19 °C WB, chilled water: 7 °C/12 °C. 3) According to Eurovent standard. Air: 20 °C, hot water: 45 °C/40 °C. 4) According to Eurovent standard. Air: 20 °C, hot water: 65 °C/55 °C. 5) Informative data, considering an hypothetical sound attenuation of the room and installation of 9 dB(A). 6) According to Eurovent. \* Drain pump and G1 air filter are included as standard.

Accessories and options

- 2 way or 3 way valves
- Auxiliary drain pan
- Electric heaters (from 1500 W to 3000 W)
- Electromechanical sensor for automatic change over
- Fresh air intake
- G4 filter
- IRC: infrared remote control for Plogic
- Modbus communication board for Plogic

Accessories and options

- Plastic or metallic (IRYS COANDA) diffusers (mandatory)
- SRC - mini BMS controller
- Plogic controller (other electromechanical or electronic control systems also available)
- TControl EASY 3S and TControl POD glass controllers (other electromechanical or electronic control systems also available)
- WRC: wall-mounted remote control for Plogic



ErP compliant following COMMISSION REGULATION (EU) 2016/2281.



# Fan coil cassette EC fan

Fan coil cassette units with cooling and heating.

**Cooling capacity: 1,3 to 9,6 kW.**

**Heating capacity: 1,1 to 14,0 kW.**



Optional controller.  
WRC remote control.



Optional controller.  
SRC - mini BMS  
controller.



Optional controller.  
Electronic controller  
TControl POD glass.



Optional controller.  
Electronic controller  
TControl EASY 3S.



Optional controller.  
Wired remote controller  
with touch control.  
PAW-FC-907EC



Optional controller.  
Wired remote controller.  
PAW-FC-903EC

## Operating limits

Entering water temperature (without glycol).

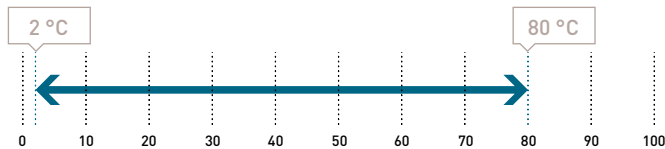

Indoor air temperature.

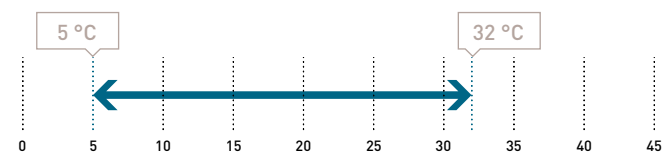

## The range at a glance

- Versions: 2-pipes, 2-pipes + electric heater and 4-pipes
- 6 sizes
- Low energy consumption EC fan: 100% controllable via a 0-10 V signal or 3 operating speeds
- Air flow from 360 to 1598 m<sup>3</sup>/h
- Integrated condensate drain pump
- G1 cleanable air filter

## Advantages

- Excellent performances: FCEER and FCCOP up to "A"
- Aesthetic and IRYS COANDA design diffusers with strong coanda effect
- Silent units
- Easy installation and maintenance: all connections on the same side. Electrical box and valves outside of the unit
- Low built-in-height
- Perfect integration into standard 600 x 600 ceiling tiles\*
- Valves and drain pump factory mounted

\* From 20 to 40 with IRYS COANDA diffusers.

## IRYS COANDA diffusers.

For a unique design and a strong coanda effect.



**IRYS COANDA 360.**  
360° air diffusion.



**IRYS COANDA 180.**  
180° air diffusion.

Coanda effect measurements taken in our Panasonic development center.

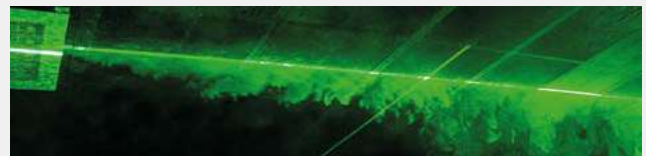

+ SEE PAGE 580 FOR MORE DETAILS ABOUT FAN COIL CONTROLLERS

## AC SELECT.

Smart and user-friendly the new air conditioning selection program: <https://acselect.panasonic.eu/>





## Technical features

Fan coil cassette EC fan		P-FQ20		P-FQ30		P-FQ40		P-FQ50		P-FQ60		P-FQ70		
		2V/6V/10V <sup>1)</sup>		2V/6V/10V <sup>1)</sup>		2V/6V/10V <sup>1)</sup>		2V/6V/10V <sup>1)</sup>		2V/6V/10V <sup>1)</sup>		2V/6V/10V <sup>1)</sup>		
<b>2-pipes</b>														
Total cooling capacity <sup>2)</sup>	kW	1,55/1,77/2,38	1,88/2,88/4,00	2,79/3,51/4,71	3,36/4,44/6,09	3,71/5,48/7,20	4,05/6,51/9,61							
Sensible capacity <sup>2)</sup>	kW	1,30/1,49/2,00	1,42/2,18/3,05	2,09/2,69/3,64	2,53/3,36/4,49	2,69/4,08/5,44	2,98/4,88/7,21							
Water flow <sup>2)</sup>	l/h	267/306/409	325/497/688	481/604/808	579/765/1050	640/944/1243	700/1119/1649							
Water pressure drop <sup>2)</sup>	kPa	4,0/5,0/10,0	3,0/7,0/14,0	6,0/10,0/18,0	7,0/12,0/22,0	3,0/6,0/11,0	5,0/12,0/25,0							
Heating capacity <sup>3)</sup>	kW	1,92/2,17/2,74	1,94/3,15/3,68	3,16/3,92/5,28	3,80/5,08/6,84	3,85/6,26/8,51	4,38/7,95/11,03							
Water flow <sup>3)</sup>	l/h	331/374/472	334/543/634	544/675/909	655/875/1178	663/1078/1466	754/1369/1900							
Water pressure drop <sup>3)</sup>	kPa	6,0/7,0/10,0	3,0/9,0/11,0	7,0/10,0/17,0	8,0/13,0/22,0	3,0/8,0/14,0	6,0/17,0/29,0							
<b>4-pipes</b>														
Total cooling capacity <sup>2)</sup>	kW	1,30/1,49/1,99	2,00/2,69/3,38	2,56/3,23/4,02	—	2,99/4,98/6,65	3,18/6,04/7,97							
Sensible capacity <sup>2)</sup>	kW	1,19/1,39/1,86	1,50/2,08/2,66	2,04/2,60/3,32	—	2,25/3,79/5,08	2,39/4,71/6,34							
Water flow <sup>2)</sup>	l/h	234/262/344	344/464/581	442/556/690	—	516/858/1144	549/1041/1366							
Water pressure drop <sup>2)</sup>	kPa	6,0/8,0/13,0	4,0/7,0/11,0	6,0/10,0/15,0	—	5,0/14,0/24,0	6,0/20,0/33,0							
Heating capacity <sup>4)</sup>	kW	1,09/1,27/1,67	3,10/4,40/5,46	4,32/5,00/5,80	—	5,28/7,79/10,00	6,43/10,67/13,99							
Water flow <sup>4)</sup>	l/h	94/109/144	267/379/470	372/431/500	—	455/671/865	554/867/1205							
Water pressure drop <sup>4)</sup>	kPa	13,0/17,0/28,0	7,0/13,0/20,0	13,0/17,0/23,0	—	4,0/7,0/11,0	5,0/11,0/19,0							
<b>Sound levels</b>														
Sound power	2-pipes	dB(A)	36/40/49	35/44/53	42/48/57	35/40/49	38/46/54	40/52/61						
	4-pipes	dB(A)	36/40/49	35/44/53	42/48/57	—	38/46/54	40/52/61						
Sound pressure <sup>5)</sup>	2-pipes	dB(A)	27/31/40	26/35/44	33/39/48	26/31/40	29/37/45	31/43/50						
	4-pipes	dB(A)	27/31/40	26/35/44	33/39/48	—	29/37/45	31/43/50						
NR <sup>5)</sup>	2-pipes		23/27/35	20/30/39	28/34/43	21/26/35	22/32/40	25/38/45						
	4-pipes		23/27/35	20/30/39	28/34/43	—	22/32/40	25/38/45						
<b>Ventilation</b>														
Number of fans			1	1	1	1	1	1	1	1	1	1	1	
Air flow	m <sup>3</sup> /h		360/450/659	320/504/734	486/626/900	529/720/979	500/824/1159	601/1080/1598						
Filter			G1	G1	G1	G1	G1	G1						
<b>Electrical data</b>														
Power supply	Voltage	V	230	230	230	230	230	230						
	Phase		Single phase	Single phase	Single phase	Single phase	Single phase	Single phase						
	Frequency	Hz	50/60	50/60	50/60	50/60	50/60	50/60						
Consumption	2-pipes	W	9/13/29	7/14/33	13/23/57	7/12/25	9/23/45	11/40/115						
	4-pipes	W	9/13/29	7/14/32	13/22/57	—	9/23/45	11/40/115						
Electric heater	W		1500	2500	2500	2x1500	2x1500	2x1500						
<b>Water connections</b>														
Connection type			Female gas threaded	Female gas threaded	Female gas threaded	Female gas threaded	Female gas threaded	Female gas threaded						
2 or 4-pipes	Cooling	Inch	¾	¾	¾	1	1	1						
4-pipes	Heating	Inch	½	½	½	—	¾	¾						
<b>Dimension</b>														
With plastic diffuser	H x W x D	mm	334 x 720 x 720	334 x 720 x 720	334 x 720 x 720	339 x 960 x 960	339 x 960 x 960	339 x 960 x 960						
With IRYS COANDA 180	H x W x D	mm	353 x 595 x 595	353 x 595 x 595	353 x 595 x 595	366 x 849 x 849	366 x 849 x 849	366 x 849 x 849						
With IRYS COANDA 360	H x W x D	mm	341 x 595 x 595	341 x 595 x 595	341 x 595 x 595	358 x 849 x 849	358 x 849 x 849	358 x 849 x 849						
<b>Weight</b>														
Weight	kg		14,8	16,5	16,5	37,1	37,1	39,6						

Energy efficiency class <sup>6)</sup>

Fan coil cassette EC fan		FCEER	A to E	B	A	B	A	A	A
2-pipes	FCCOP	A to E	B	B	B	A	A	A	A
	FCEER	A to E	B	A	B	—	A	B	B
4-pipes	FCCOP	A to E	C	A	B	—	A	A	A

1) Fan standard factory set speeds (voltage). 2) According to Eurovent standard. Air: 27 °C DB/19 °C WB, chilled water: 7 °C/12 °C. 3) According to Eurovent standard. Air: 20 °C, hot water: 45 °C/40 °C. 4) According to Eurovent standard. Air: 20 °C, hot water: 65 °C/55 °C. 5) Informative data, considering an hypothetical sound attenuation of the room and installation of 9 dB(A). 6) According to Eurovent. \* Drain pump and G1 air filter are included as standard.

## Accessories and options

2 way or 3 way valves
Auxiliary drain pan
Ecospeed card for EC fans
Electric heaters (from 1500 W to 3000 W)
Electromechanical sensor for automatic change over
Fresh air intake
G4 filter
IRC: infrared remote control for Plogic

## Accessories and options

Modbus communication board for Plogic
Plastic or metallic (IRYS COANDA) diffusers (mandatory)
SRC - mini BMS controller
Plogic controller (other electromechanical or electronic control systems also available)
TControl EASY 3S and TControl POD glass controllers (other electromechanical or electronic control systems also available)
WRC: wall-mounted remote control for Plogic



ErP compliant following COMMISSION REGULATION (EU) 2016/2281.



# New fan coil wall DC fan – FK1

Fan coil wall units with new stylish design and nanoe™ X (Mark 3).

**Cooling capacity: 1,9 to 5,2 kW.**

**Heating capacity: 2,2 to 5,3 kW.**

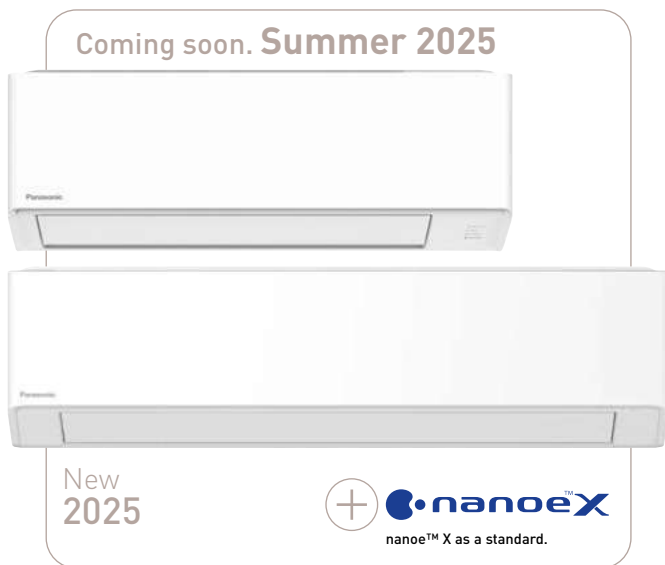

Optional controller.  
WRC remote control.



Optional controller.  
SRC - mini BMS  
controller.



Optional controller.  
Electronic controller  
TControl POD glass.



Optional controller.  
Electronic controller  
TControl EASY 3S.



Optional controller.  
Wired remote controller  
with touch control.  
PAW-FC-907EC



Optional controller.  
Wired remote controller.  
PAW-FC-903EC



Optional controller. CONEX  
Series, white or black.  
CZ-RTC6W/BL/BLW2 or  
CZ-RTC6/BL/BLW2



Optional controller.  
Wired remote controller  
with Econavi function.  
CZ-RTC5B



Optional controller.  
Infrared remote controller  
for wall-mounted.  
CZ-RWS3

## The range at a glance

- Versions (2-pipes): with 3 way valve
- 6 sizes
- DC fan for better efficiency and control
- Air flow from 360 to 1045 m<sup>3</sup>/h
- G1 cleanable air filter

## Advantages

- Modern stylish design with flat face and compact size
- Motorized louvers
- Six directional piping outlet
- nanoe™ X (Generator Mark 3) as standard for better indoor air quality
- Quieter operation than AC fan models
- Very easy servicing through a removable front panel
- Cleanable synthetic-type air filter
- Compatibility with a wide range of controllers
- Ideal for commercial and residential applications in combination with Aquarea Heat Pumps

## Accessories and options

Modbus communication board for Plologic

SRC - mini BMS controller

WRC: wall-mounted remote control for Plologic

Plologic controller (other electromechanical or electronic control systems also available)

TControl EASY 3S and TControl POD glass controllers (other electromechanical or electronic control systems also available)

CZ-RWS3 - infrared remote controller

CZ-RTC5B - wired remote controller with Econavi function

CZ-RTC6 - CONEX Series wired remote controller

CZ-CENSC1 - Econavi energy saving sensor

## Operating limits

Entering water temperature (without glycol).

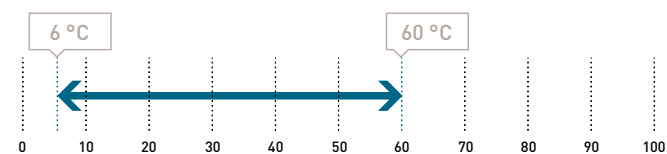

Maximum operating pressure: 10 bar.

Indoor air temperature.

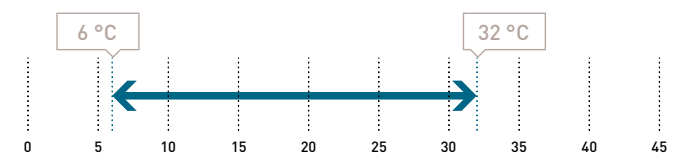

+ SEE PAGE 580 FOR MORE DETAILS ABOUT FAN COIL CONTROLLERS

## AC SELECT.

Smart and user-friendly the new air conditioning selection program: <https://acselect.panasonic.eu/>



Technical features

Fan coil wall DC fan - FK1		S-19FK1E	S-24FK1E	S-27FK1E	S-36FK1E	S-45FK1E	S-52FK1E
		H/M/L	H/M/L	H/M/L	H/M/L	H/M/L	H/M/L
<b>2-pipes, with/without 3 way valve</b>							
Total cooling capacity <sup>1)</sup>	kW	1,90/1,65/1,40	2,41/2,17/1,92	2,73/2,51/2,02	3,61/3,11/2,65	4,50/3,78/3,02	5,23/4,63/4,03
Sensible capacity <sup>1)</sup>	kW	1,54/1,35/1,10	1,91/1,71/1,50	2,19/2,00/1,59	2,98/2,52/2,12	3,41/2,84/2,25	4,02/3,51/3,04
Water flow <sup>1)</sup>	l/h	342/295/250	432/389/344	489/449/362	648/556/473	809/680/539	908/830/724
Water pressure drop (coil only)	kPa	8/6/4	13/11/8	17/14/9	30/22/16	42/30/19	56/44/34
Water pressure drop (with 3 way valve) <sup>1)</sup>	kPa	29/23/18	36/29/25	44/39/26	74/57/42	110/80/53	142/112/90
Air flow <sup>1)</sup>	m <sup>3</sup> /h	345/276/230	416/361/324	480/434/343	710/572/462	753/603/488	879/753/637
Input power <sup>1)</sup>	W	12/11/10	14/12/12	16/14/12	26/19/15	22/17/13	29/23/18
Sound pressure Lp <sup>1)2)</sup>	dB(A)	27	26	29	39	35	40
Sound power Lw <sup>1)</sup>	dB(A)	43	42	45	55	51	56
Heating capacity <sup>3)</sup>	kW	2,23/1,92/1,59	2,72/2,39/1,97	3,01/2,64/2,18	4,03/3,48/2,89	5,13/4,21/3,09	5,33/4,72/4,03
Water flow <sup>3)</sup>	l/h	381/329/281	481/417/339	533/463/379	715/614/508	898/740/544	931/827/710
Water pressure drop (coil only)	kPa	10/8/5	16/12/8	20/15/10	36/27/18	52/36/19	56/44/33
Water pressure drop (with 3 way valve) <sup>3)</sup>	kPa	30/24/18	39/31/23	47/36/25	72/60/42	118/82/46	128/97/74
Air flow <sup>3)</sup>	m <sup>3</sup> /h	406/314/253	489/425/343	545/471/379	765/646/517	925/730/511	960/810/672
Input power <sup>3)</sup>	W	13/12/10	15/14/12	17/15/13	28/21/16	32/21/14	35/26/19
Sound pressure Lp <sup>2)3)</sup>	dB(A)	29/27/24	29/26/22	32/28/23	41/36/30	42/36/28	43/39/34
Sound power Lw <sup>3)</sup>	dB(A)	45/43/40	45/42/38	48/44/39	57/52/46	58/52/44	59/55/50
<b>Water Connection</b>							
Connection type		Gas female threaded	Gas female threaded	Gas female threaded	Gas female threaded	Gas female threaded	Gas female threaded
	Inch	1/2	1/2	1/2	1/2	1/2	1/2
nanoe X Generator		Mark 3	Mark 3	Mark 3	Mark 3	Mark 3	Mark 3
<b>Dimensions and weight</b>							
Dimension	H x W x D	mm 295 x 890 x 244	295 x 890 x 244	295 x 890 x 244	295 x 890 x 244	295 x 1060 x 249	295 x 1060 x 249
Weight	kg	12	13	13	13	14	14

Energy efficiency class <sup>1)</sup>

Fan coil wall DC fan - FK1		S-19FK1E		S-24FK1E		S-27FK1E		S-36FK1E		S-45FK1E		S-52FK1E	
2-pipes	FCEER <sup>1)</sup>	A to E	B	B	B	B	B	A	A				
	$\eta_{s,c}$	%	144,2	166,9	172,1	169,3	226,8	213,0					
	FCCOP <sup>3)</sup>	A to E	B	B	B	B	B	B					
	$\eta_{s,h}$	%	160,0	167,0	170,5	173,4	208,5	198,0					

1) According to Eurovent standard. Air: 27 °C DB/19 °C WB, chilled water: 7 °C/12 °C. 2) The sound pressure of the indoor unit shows the value measured of a position of 1 m in front of the main body and 0,8 m below the unit. The sound pressure is measured in accordance with JIS C 9612. 3) According to Eurovent standard. Air: 20 °C, hot water: 45 °C/40 °C.

New fan coil wall.

First Panasonic water fan coil unit integrated with nanoe™ X technology.

Fan coil wall unit with stylish design, ideal for commercial and residential applications in combination with Aquarea Heat Pumps. The units are integrated with nanoe™ X technology to improve protection 24/7 (Generator Mark 3).

Bringing nature's balance indoors.

The new fan coil wall is equipped with nanoe™ X for improved indoor air quality. nanoe™ X, technology with the benefits of hydroxyl radicals.



7 effects of nanoe™ X – Panasonic unique technology.

Capacity to inhibit 5 types of pollutants



Deodorises



Odours

Moisturises



Skin and hair



ErP compliant following COMMISSION REGULATION (EU) 2016/2281.

# Fan coil wall AC fan

Fan coil wall units with cooling and heating.

**Cooling capacity: 1,0 to 4,0 kW.**

**Heating capacity: 1,4 to 4,5 kW.**



Optional controller.  
WRC remote control.



Optional controller.  
SRC - mini BMS  
controller.



Optional controller.  
Electronic controller  
TControl POD glass.



Optional controller.  
Electronic controller  
TControl EASY 3S.



Optional controller.  
Wired remote  
controller with  
touch control.  
PAW-FC-907AC



Optional controller.  
Wired remote  
controller.  
PAW-FC-903AC



Optional controller.  
Advanced wired  
remote controller.  
PAW-FC-RC1

## The range at a glance

- Versions (2-pipes): infrared without valve (IR SV), infrared with valve (IR AV) and terminal block without valve (TB SV)
- 4 sizes
- 3-speed AC fan
- Air flow from 280 to 850 m<sup>3</sup>/h
- G1 cleanable air filter

## Advantages

- Reversible
- Aesthetic design
- Light for easy installation
- Silent units
- Very easy servicing through a removable front panel
- Cleanable synthetic-type air filter

## Accessories and options

2 way or 3 way valves

Modbus communication board for Plogic

SRC - mini BMS controller

Plogic controller (other electromechanical or electronic control systems also available)

TControl EASY 3S and TControl POD glass controllers (other electromechanical or electronic control systems also available)

WRC: wall-mounted remote control for Plogic

## Operating limits

Entering water temperature (without glycol).

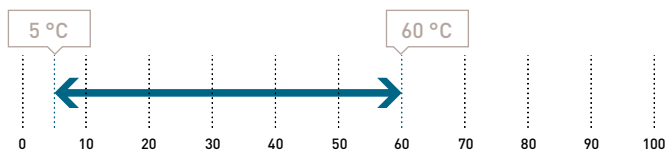

Indoor air temperature.

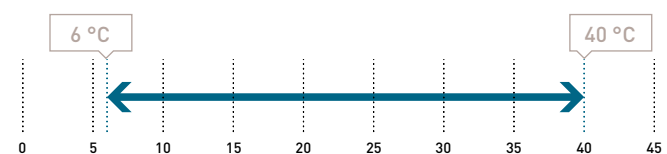

+ SEE PAGE 580 FOR MORE DETAILS ABOUT FAN COIL CONTROLLERS

## AC SELECT.

Smart and user-friendly the new air conditioning selection program: <https://acselect.panasonic.eu/>



## Technical features

Fan coil wall AC fan		P-FW07(IR) S2/S3/S4 <sup>1)</sup>	P-FW09(IR) S2/S3/S4 <sup>1)</sup>	P-FW18(IR) S2/S3/S4 <sup>1)</sup>	P-FW22(IR) S2/S3/S4 <sup>1)</sup>
<b>2-pipes, without valve, without/with IR infrared control</b>					
Total cooling capacity <sup>2)</sup>	kW	1,00/1,34/1,69	1,58/1,79/2,50	2,78/3,05/3,60	2,93/3,29/4,00
Sensible capacity <sup>2)</sup>	kW	0,72/0,97/1,20	1,21/1,37/1,87	2,12/2,39/2,74	2,28/2,62/3,11
Water flow <sup>2)</sup>	l/h	172/231/291	270/308/431	479/525/620	505/565/687
Water pressure drop <sup>2)</sup>	kPa	18,6/24,9/31,4	18,5/21,4/31,0	34,6/40,0/52,3	37,2/42,8/54,9
Heating capacity <sup>3)</sup>	kW	1,42/1,62/1,72	1,68/1,92/2,80	2,99/3,30/4,10	3,18/3,63/4,50
Water flow <sup>3)</sup>	l/h	245/279/296	289/331/482	515/568/706	548/625/775
Water pressure drop <sup>3)</sup>	kPa	17,6/23,4/26,5	21,4/23,5/28,6	39,9/46,3/64,7	41,7/55,0/85,8
<b>Sound levels</b>					
Sound power	dB(A)	45/49/51	40/43/52	47/50/54	50/55/60
Sound pressure <sup>4)</sup>	dB(A)	30/33/35	32/36/40	39/41/43	39/43/48
NR <sup>4)</sup>	dB(A)	32/36/38	34/39/44	40/43/46	43/46/50
<b>Ventilation</b>					
Number of fans		1	1	1	1
Air flow	m <sup>3</sup> /h	282/321/360	367/413/551	532/592/680	617/709/850
Filter		G1	G1	G1	G1
<b>Electrical data</b>					
Power supply	Voltage	V	230	230	230
	Phase		Single phase	Single phase	Single phase
	Frequency	Hz	50	50	50
Consumption	Cooling	W	39/42/62	30/33/40	44/48/53
	Heating	W	39/42/62	27/30/50	42/45/60
<b>Water connections</b>					
Connection type		Female gas threaded	Female gas threaded	Female gas threaded	Female gas threaded
Connections	Inch	½	½	½	½
<b>Dimension and weight</b>					
Dimension	H x W x D	mm	275 x 845 x 180	275 x 845 x 180	298 x 940 x 200
Weight		kg	11	11	13
Fan coil wall AC fan		P-FW09IR-3W S2/S3/S4 <sup>1)</sup>		P-FW22IR-3W S2/S3/S4 <sup>1)</sup>	
<b>2-pipes, with valve, with IR infrared control</b>					
Total cooling capacity <sup>2)</sup>	kW	1,11/1,25/1,40		2,32/2,68/3,10	
Sensible capacity <sup>2)</sup>	kW	0,91/1,08/1,25		1,68/1,98/2,28	
Water flow <sup>2)</sup>	l/h	191/215/241		400/460/532	
Water pressure drop <sup>2)</sup>	kPa	14,9/16,8/18,8		42,4/50,8/61,5	
Heating capacity <sup>3)</sup>	W	1,29/1,61/2,00		2,51/2,75/3,30	
Water flow <sup>3)</sup>	l/h	222/277/344		432/474/568	
Water pressure drop <sup>3)</sup>	kPa	16,1/21,3/28,2		45,8/48,6/54,1	
<b>Sound levels</b>					
Sound power	dB(A)	44/50/54		53/57/60	
Sound pressure <sup>4)</sup>	dB(A)	32/36/40		39/43/48	
NR <sup>4)</sup>	dB(A)	27/31/37		34/37/41	
<b>Ventilation</b>					
Number of fans		1		1	
Air flow	m <sup>3</sup> /h	150/250/400		290/400/600	
Filter		G1		G1	
<b>Electrical data</b>					
Power supply	Voltage	V	230		230
	Phase		Single phase		Single phase
	Frequency	Hz	50		50
Consumption	Cooling	W	35/38/43		50/58/69
	Heating	W	30/33/43		50/58/69
<b>Water connections</b>					
Connection type		Female gas threaded		Female gas threaded	
Connections	Inch	½		½	
<b>Dimension and weight</b>					
Dimension	H x W x D	mm	275 x 845 x 180		298 x 940 x 200
Weight		kg	11		13

1) Fan standard factory set speeds. 2) According to Eurovent standard. Air: 27 °C DB/19 °C WB, chilled water: 7 °C/12 °C. 3) According to Eurovent standard. Air: 20 °C, hot water: 45 °C/40 °C. 4) Informative data, considering an hypothetical sound attenuation of the room and installation of 9 dB(A).



ErP compliant following COMMISSION REGULATION (EU) 2016/2281.



# Fan coil duct EC fan

Fan coil medium static pressure ductable units with cooling and heating.

**Cooling capacity: 0,7 to 6,7 kW.**

**Heating capacity: 0,5 to 7,1 kW.**



Optional controller.  
WRC remote control.



Optional controller.  
SRC - mini BMS  
controller.



Optional controller.  
Electronic controller  
TControl POD glass.



Optional controller.  
Electronic controller  
TControl EASY 3S.



Optional controller.  
Wired remote controller  
with touch control.  
PAW-FC-907EC



Optional controller.  
Wired remote controller.  
PAW-FC-903EC

## Operating limits

Entering water temperature (without glycol).

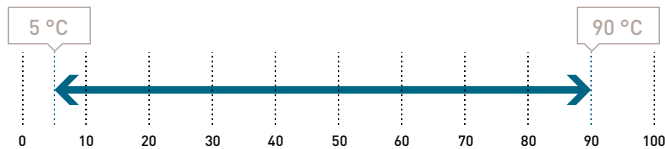

Indoor air temperature.

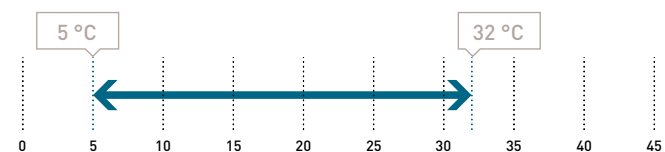

## The range at a glance

- Versions: 2-pipes, 2-pipes + electric heater and 4-pipes
- 6 sizes
- Low energy consumption EC fan: 100% controllable via a 0-10 V signal or 3 operating speeds
- Air flow from 82 to 1293 m<sup>3</sup>/h
- Static pressure up to 120 Pa
- Many air inlet/outlet configurations
- Left or right water / electric connections

## Advantages

- Excellent performances: FCEER and FCCOP up to "A"
- Silent units: internal acoustic and thermal insulation
- Highly customisable: many aeraulic configurations and selection of hydraulic, and electric service side
- Ease of installation: very low height (223 mm)
- Easy maintenance: direct access to the internal components
- Mono-bloc drain pan
- 100% factory tested

## Air inlet/outlet configurations.

### I configurations.

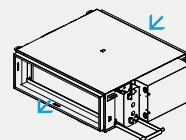

Rectangular return and  
discharge (standard).

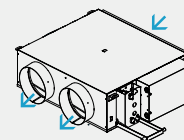

Rectangular return and  
circular discharge.

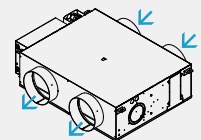

Circular return and  
discharge.

### J configuration.

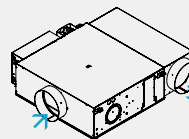

Circular return and  
discharge.

### L configuration.

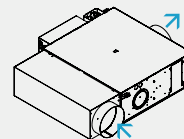

Circular return and  
discharge.

### U configuration.

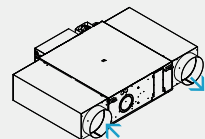

Circular return and  
discharge.

+ SEE PAGE 580 FOR MORE DETAILS ABOUT FAN COIL CONTROLLERS

## AC SELECT.

Smart and user-friendly the new air conditioning selection program: <https://acselect.panasonic.eu/>



## Technical features

Fan coil duct EC fan		P-FD10		P-FD15		P-FD20		P-FD25		P-FD30		P-FD40		
		2V/7,35V/10V <sup>1)</sup>		3,8V/6,00V/8,2V <sup>1)</sup>		4,8V/7,15V/8,9V <sup>1)</sup>		3,1V/3,9V/4,85V <sup>1)</sup>		2V/6V/10V <sup>1)</sup>		2,1V/5,5V/10V <sup>1)</sup>		
<b>2-pipes</b>														
Total cooling capacity <sup>2)</sup>	kW	0,7/1,2/1,5		1,39/1,88/2,06		1,83/2,42/2,74		2,42/2,77/3,2		1,90/3,66/4,80		2,4/4,94/6,66		
Sensible capacity <sup>2)</sup>	kW	0,67/1,08/1,36		1,16/1,6/1,96		1,46/1,92/2,21		1,96/2,24/2,63		1,42/2,82/3,68		1,8/4,1/6,13		
Water flow <sup>2)</sup>	l/h	121/207/258		239/324/355		315/416/472		416/477/551		327/630/827		413/851/1148		
Water pressure drop <sup>2)</sup>	kPa	2,38/5,29/7,52		6,1/9,3/10,5		9,5/15,5/19,5		19,7/25,3/33,1		15,2/44/70,3		8,2/29,7/51,7		
Heating capacity <sup>3)</sup>	kW	0,51/1,28/1,82		1,45/2,07/2,55		2,07/2,47/2,59		2,58/3,02/3,39		1,90/3,83/5,01		2,4/5,1/7,06		
Water flow <sup>3)</sup>	l/h	87,8/220/313		250/357/439		357/425/446		444/520/584		327/660/863		410/878/1216		
Water pressure drop <sup>3)</sup>	kPa	1,54/5,85/10,3		6,5/10,6/14,3		11,9/16,1/17,6		22,3/30/37,3		10,3/37,6/62,8		8,2/31,4/57,6		
<b>4-pipes</b>														
Total cooling capacity <sup>2)</sup>	kW	0,71/1,35/1,58		1,34/1,78/2,18		1,78/2,38/2,74		2,19/2,69/2,94		1,72/3,54/4,57		2,22/4,76/6,37		
Sensible capacity <sup>2)</sup>	kW	0,67/1,20/1,42		1,11/1,52/1,73		1,42/1,9/2,22		1,73/2,16/2,39		1,24/2,61/3,39		1,77/4,02/5,63		
Water flow <sup>2)</sup>	l/h	122/233/272		231/307/376		306/410/472		377/463/506		296/610/787		382/821/1097		
Water pressure drop <sup>2)</sup>	kPa	2,43/6,36/8,18		5,8/8,5/11,4		9,1/15,1/19,5		13,3/19,4/22,9		8,6/32,4/52,7		7,2/27,8/57,1		
Heating capacity <sup>4)</sup>	kW	0,65/1,66/2,16		1,79/2,54/2,88		2,6/3,02/3,12		3,16/3,59/4,03		1,73/3,27/4,10		2,64/5,05/6,61		
Water flow <sup>4)</sup>	l/h	56/143/186		154/219/248		224/260/269		308/344/385		149/282/353		227/435/569		
Water pressure drop <sup>4)</sup>	kPa	1,36/4,88/7,24		5,9/11,1/13,9		12,1/18/19,7		11,5/14,9/18,9		3,27/12,3/19,6		3,5/37,3/120		
<b>Sound levels</b>														
Sound power return - radiated <sup>5)</sup>	2-pipes	dB(A)	31/52/55		44/55/60		46/57/61		50/55/61		40/58/64		42/58/68	
	4-pipes	dB(A)	29/52/55		44/55/60		50/57/61		50/55/61		40/58/64		43/58/68	
Sound power - discharge <sup>5)</sup>	2-pipes	dB(A)	31/51/55		41/52/58		50/57/61		50/56/61		36/56/64		39/57/70	
	4-pipes	dB(A)	34/51/57		41/52/58		50/57/61		50/56/61		36/56/64		38/54/70	
Sound pressure <sup>6)</sup>	2-pipes	dB(A)	<20/35/38		26/37/42		31/40/44		33/39/44		20/39/47		23/39/52	
	4-pipes	dB(A)	<20/35/38		26/37/42		31/40/44		33/39/44		20/39/47		24/39/52	
NR <sup>6)</sup>	2-pipes		9/30/33		21/32/37		26/35/39		28/34/39		15/34/42		18/34/47	
	4-pipes		6/30/33		21/32/37		26/35/39		28/34/39		15/34/42		19/34/47	
<b>Ventilation</b>														
Number of fans			1		1		1		1		1		1	
Air flow <sup>5)</sup>	2-pipes	m <sup>3</sup> /h	82/247/357		255/383/491		360/501/599		448/541/642		300/738/1068		347/848/1293	
	4-pipes	m <sup>3</sup> /h	85/292/384		228/351/452		331/467/560		413/503/602		255/654/943		319/802/1228	
External static pressure	2-pipes	Pa	3,3/30/62,6		22/50/82		26/50/72		34/50/70		8/50/105		8/50/116	
	4-pipes	Pa	2,5/30/51,8		21/50/83		25/50/72		34/50/72		8/50/104		8/50/117	
<b>Electrical data</b>														
Power supply	Voltage	V	230		230		230		230		230		230	
	Phase		Single phase		Single phase		Single phase		Single phase		Single phase		Single phase	
	Frequency	Hz	50/60		50/60		50/60		50/60		50/60		50/60	
Consumption	2-pipes	W	7/19/35		11/29/56		19/50/70		25/41/64		9/65/163		10/62/197	
	4-pipes	W	7/20/36		11/28/53		20/47/76		26/41/69		8/60/147		10/60/188	
Electric heater	W	500		600/1000		600/1000		1000/2000		1000/2000		1250/2500		
<b>Water connections</b>														
Connection type			Female gas threaded		Female gas threaded		Female gas threaded		Female gas threaded		Female gas threaded		Female gas threaded	
2 or 4-pipes	Cooling	Inch	½		½		½		½		½		¾	
4-pipes	Heating	Inch	½		½		½		½		½		½	
<b>Dimension and weight</b>														
Dimension without drain pan	H x W x D	mm	223 x 633 x 631		223 x 733 x 631		223 x 833 x 631		223 x 933 x 631		223 x 933 x 631		223 x 1233 x 653	
Weight		kg	14		16		18		20		22		29	

Energy efficiency class<sup>7)</sup>

Fan coil duct EC fan		FCEER	A to E	C	B	B	B	B	B	A
2-pipes	FCEER	A to E	C	B	B	B	B	B	B	A
	FCCOP	A to E	C	A	B	A	B	B	B	A
4-pipes	FCEER	A to E	C	B	B	B	B	B	B	A
	FCCOP	A to E	C	A	A	A	A	B	B	A

1) Fan standard factory set speeds (voltage). 2) According to Eurovent standard. Air: 27 °C DB/19 °C WB, chilled water: 7 °C/12 °C. 3) According to Eurovent standard. Air: 20 °C, hot water: 45 °C/40 °C. 4) According to Eurovent standard. Air: 20 °C, hot water: 65 °C/55 °C. 5) According to Eurovent 6/10 (air flow test method) and 8/12 (sound test method). 6) Informative data, considering an hypothetical sound attenuation of the room and installation of 21 dB(A). 7) According to Eurovent. \* Data with I configuration with rectangular return and discharge and G2 (P-FD10/15/20/25/30) or G3 (P-FD40) filter.

## Accessories and options

2 way or 3 way valves

Circuit breakers

Condensate drain pump

Ecospeed card for EC fans

Electric heaters (from 500 W to 2500 W)

Fresh air intake

Fuse holder

G2/G3 filter

## Accessories and options

Many air inlet/outlet configurations

Electromechanical sensor for automatic change over

Modbus communication board for Plogic

Other speeds configuration (standard factory set speeds in technical features table)

SRC - mini BMS controller

Suspension kit

## Accessories and options

Plogic controller (other electromechanical or electronic control systems also available)

TControl EASY 3S and TControl POD glass controllers (other electromechanical or electronic control systems also available)

WRC: wall-mounted remote control for Plogic



ErP compliant following COMMISSION REGULATION (EU) 2016/2281.



# Fan coil high static duct AC fan

Fan coil high static pressure ductable units with cooling and heating.

**Cooling capacity: 4,1 to 24,8 kW.**

**Heating capacity: 4,1 to 25,0 kW.**



Optional controller.  
WRC remote control.



Optional controller.  
SRC - mini BMS  
controller.



Optional controller.  
Electronic controller  
TControl POD glass.



Optional controller.  
Electronic controller  
TControl EASY 3S.



Optional controller.  
Wired remote  
controller with  
touch control.  
PAW-FC-907AC



Optional controller.  
Wired remote  
controller.  
PAW-FC-903AC



Optional controller.  
Advanced wired  
remote controller.  
PAW-FC-RC1

## Operating limits

Entering water temperature (without glycol).

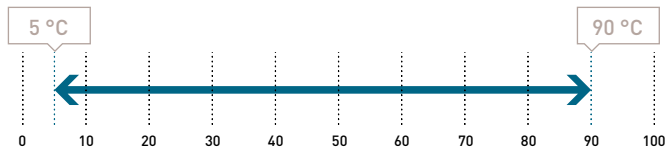

Indoor air temperature.

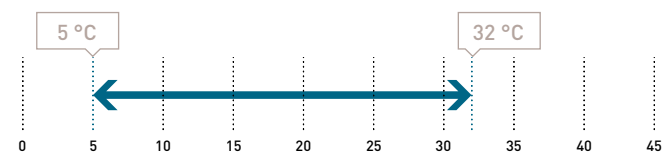

## The range at a glance

- Versions: 2-pipes, 2-pipes + electric heater and 4-pipes
- 6 sizes
- 5 or 4-speed AC fan - standard factory set speeds.  
07/15/18/21: S1,S3,S5 (5-speed fan motor) and 24/27:  
S1,S2,S3 (4-speed fan motor)
- Air flow from 586 to 3451 m<sup>3</sup>/h
- High available static pressure up to 220 Pa
- Left or right water / electric connections

## Advantages

- Very low acoustic level at low speed (double skin insulation available as an accessory)
- Selection of hydraulic and electric service side
- Ease of installation and maintenance
- 100% factory tested

## Accessories and options

2 way or 3 way valves
Auxiliary drain pan
Circuit breakers
Condensate drain pump
Double skin acoustic insulation
Electric heaters (from 1000 W to 3000 W)
Fresh air intake
Fuse holder
G3/G4 filter
Inlet and outlet plenums for circular ducts (07 only)
Electromechanical sensor for automatic change over
Modbus communication board for Plologic
Other speeds configuration (standard factory set speeds in technical features table)
SRC - mini BMS controller
Suspension kit
Plologic controller (other electromechanical or electronic control systems also available)
TControl EASY 3S and TControl POD glass controllers (other electromechanical or electronic control systems also available)
WRC: wall-mounted remote control for Plologic

+ SEE PAGE 580 FOR MORE DETAILS ABOUT FAN COIL CONTROLLERS

## AC SELECT.

Smart and user-friendly the new air conditioning selection program: <https://acselect.panasonic.eu/>





## Technical features

Fan coil high static duct AC fan		P-FH7		P-FH15		P-FH18		P-FH21		P-FH24		P-FH27		
		S1/S3/S5 <sup>1)</sup>		S1/S3/S5 <sup>1)</sup>		S1/S3/S5 <sup>1)</sup>		S1/S3/S5 <sup>1)</sup>		S1/S2/S3 <sup>1)</sup>		S1/S2/S3 <sup>1)</sup>		
<b>2-pipes</b>														
Total cooling capacity <sup>2)</sup>	kW	4,43/5,32/5,59		6,9/11,48/13,33		6,32/11,48/13,87		7,07/13,7/17		14,78/16,67/19,03		16,4/18,9/21,9		
Sensible capacity <sup>2)</sup>	kW	3,14/3,97/4,25		5,04/9,19/11,23		4,94/9,48/11,89		4,93/9,94/12,5		10,68/12,27/14,23		11,4/13,3/15,5		
Water flow <sup>2)</sup>	l/h	765/919/965		1191/1982/2302		1091/1982/2395		1221/2365/2935		2552/2878/3286		2832/3263/3781		
Water pressure drop <sup>2)</sup>	kPa	27,4/39,2/43,5		7,9/19,8/26,1		6,8/19,6/27,6		8,5/28,7/43,5		14,7/18,3/23,3		13,6/17,6/23		
Heating capacity <sup>3)</sup>	kW	4,06/5,53/6,7		6,6/12/15,48		7,2/14/18,01		6,95/13,9/17,8		15/17,4/20,9		15,4/17,9/21,5		
Water flow <sup>3)</sup>	l/h	701/955/1157		1140/2072/2673		1243/2417/3110		1200/2400/3073		2590/3004/3609		2659/3091/3712		
Water pressure drop <sup>3)</sup>	kPa	24,1/43,5/63,2		5/17,9/26,3		6,1/16,1/24,3		12,4/21,8/34,1		11,4/21,9/28,1		10,7/21/27,3		
<b>4-pipes</b>														
Total cooling capacity <sup>2)</sup>	kW	4,05/4,84/5,08		6,38/10,08/11,33		6,77/11,18/12,83		7,75/14,38/17,43		13,68/15,27/17,13		14,78/16,77/19,13		
Sensible capacity <sup>2)</sup>	kW	2,86/3,57/3,8		4,76/8,42/10,13		5,01/9,13/11,13		5,45/10,58/13,23		10,18/11,67/13,33		10,68/12,27/14,23		
Water flow <sup>2)</sup>	l/h	699/836/877		1102/1740/1956		1169/1930/2215		1338/2483/3009		2362/2637/2958		2552/2896/3303		
Water pressure drop <sup>2)</sup>	kPa	31/43/47,2		5,8/13,3/16,9		6,9/17,1/22,6		11,1/34,9/50,9		15,3/18,8/23,3		13,5/17/21,5		
Heating capacity <sup>4)</sup>	kW	5,5/7/7,7		9,6/17/21		9,7/17,06/21		9,7/17,1/21		10,9/12,9/15,2		18,5/25/29,6		
Water flow <sup>4)</sup>	l/h	475/604/665		829/1468/1813		837/1473/1813		837/1476/1813		941/1114/1312		1597/2158/2555		
Water pressure drop <sup>4)</sup>	kPa	9/13,3/15		32,7/92,1/134		20,2/56,1/80		20,2/56,1/80		30,8/39/49,5		38,8/67,2/82		
<b>Sound levels</b>														
Sound power return - radiated <sup>5)</sup>	2-pipes	dB(A)	57/60/63		52/66/72		54/66/74		52/66/72		65/69/73		65/69/73	
	4-pipes	dB(A)	54/60/63		52/66/72		52/66/72		52/66/72		65/69/73		65/69/73	
Sound power - discharge <sup>5)</sup>	2-pipes	dB(A)	53/59/62		52/64/71		52/64/71		52/74/71		64/67/72		64/67/72	
	4-pipes	dB(A)	53/59/62		52/64/71		52/64/71		52/64/71		64/67/72		64/67/72	
Sound pressure <sup>6)</sup>	2-pipes	dB(A)	33/39/42		31/45/51		31/45/51		31/45/51		44/48/52		44/48/52	
	4-pipes	dB(A)	33/39/42		31/45/51		31/45/51		31/45/51		44/48/52		44/48/52	
NR <sup>6)</sup>	2-pipes		27/34/37		27/40/47		27/40/47		27/40/47		40/44/48		40/44/48	
	4-pipes		27/34/37		27/40/47		27/40/47		27/40/47		40/44/48		40/44/48	
<b>Ventilation</b>														
Number of fans		1		1		1		1		1		1		
Filter		G3		G3		G3		G3		G3		G3		
Air flow <sup>5)</sup>	2-pipes	m <sup>3</sup> /h	703/977/1125		960/2112/2830		960/2112/2830		960/2112/2830		2040/2413/3436		2040/2413/3736	
	4-pipes	m <sup>3</sup> /h	586/824/974		960/2112/2830		960/2112/2830		960/2112/2830		2040/2413/3436		2040/2413/3736	
External static pressure	2-pipes	Pa	30/50/70		15/50/90		15/50/90		15/50/90		35/50/75		35/50/75	
	4-pipes	Pa	25/50/70		15/50/90		15/50/90		15/50/90		35/50/75		35/50/75	
<b>Electrical data</b>														
Power supply	Voltage	V	230		230		230		230		230		230	
	Phase		Single phase		Single phase		Single phase		Single phase		Single phase		Single phase	
	Frequency	Hz	50/60		50/60		50/60		50/60		50/60		50/60	
Consumption	W	132/182/222		180/421/675		180/421/675		180/421/675		420/530/673		420/530/673		
Electric heater	W	2000		3000		3000		3000		3000		3000		
<b>Water connections</b>														
Connection type		Female gas threaded	Male gas threaded		Male gas threaded		Male gas threaded		Male gas threaded		Male gas threaded		Male gas threaded	
2-pipes	Inch	½	1		1 ¼		1 ¼		1 ¼		1 ¼		1 ¼	
	Cooling	Inch	½		1		1		1		1 ¼		1 ¼	
4-pipes	Inch	½	¾		¾		¾		¾		¾		¾	
	Heating	Inch	½		¾		¾		¾		¾		¾	
<b>Dimension and weight</b>														
Dimension	H x W x D	mm	250 x 1200 x 698		375 x 1380 x 798		375 x 1380 x 798		375 x 1380 x 798		450 x 1500 x 798		450 x 1500 x 798	
Weight		kg	42		63		65		67		76		80	

Energy efficiency class<sup>7)</sup>

Fan coil high static duct AC fan		FCEER	A to E	D	D	D	D	D	D
2-pipes	FCEER	A to E	D	D	D	D	D	D	D
	FCCOP	A to E	C	C	C	C	C	C	C
4-pipes	FCEER	A to E	D	D	D	D	D	D	D
	FCCOP	A to E	C	C	C	C	C	C	C

1) Fan standard factory set speeds. 2) According to Eurovent standard. Air: 27 °C DB/19 °C WB, chilled water: 7 °C/12 °C. 3) According to Eurovent standard. Air: 20 °C, hot water: 45 °C/40 °C. 4) According to Eurovent standard. Air: 20 °C, hot water: 65 °C/55 °C. 5) According to Eurovent 6/10 (air flow test method) and 8/12 (sound test method). 6) Informative data, considering an hypothetical sound attenuation of the room and installation of 21 dB(A). 7) According to Eurovent. \* Data with 1 configuration with rectangular return and discharge.



ErP compliant following COMMISSION REGULATION (EU) 2016/2281.



# Fan coil high static duct EC fan

Fan coil high static pressure ductable units with cooling and heating.

**Cooling capacity: 3,2 to 21,9 kW.**

**Heating capacity: 2,5 to 24,1 kW.**



Optional controller.  
WRC remote control.



Optional controller.  
SRC - mini BMS  
controller.



Optional controller.  
Electronic controller  
TControl POD glass.



Optional controller.  
Electronic controller  
TControl EASY 3S.



Optional controller.  
Wired remote controller  
with touch control.  
PAW-FC-907EC



Optional controller.  
Wired remote controller.  
PAW-FC-903EC

## Operating limits

Entering water temperature (without glycol).

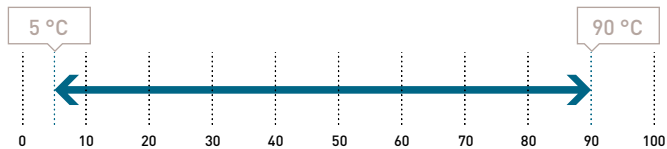

Indoor air temperature.

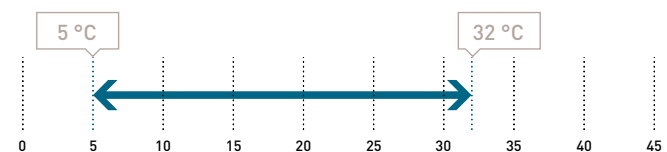

## The range at a glance

- Versions: 2-pipes, 2-pipes + electric heater and 4-pipes
- 6 sizes
- Low energy consumption EC fan: 100% controllable via a 0-10 V signal or 3 operating speeds
- Air flow from 320 to 3568 m<sup>3</sup>/h
- High available static pressure up to 220 Pa
- Left or right water / electric connections

## Advantages

- Excellent performances: FCEER and FCCOP up to "A"
- Very low acoustic level at low speed (double skin insulation available as an accessory)
- Selection of hydraulic and electric service side
- Ease of installation and maintenance
- 100% factory tested

## Accessories and options

2 way or 3 way valves
Auxiliary drain pan
Circuit breakers
Condensate drain pump
Double skin acoustic insulation
Electric heaters (from 1000 W to 3000 W)
Fresh air intake
Fuse holder
G3/G4 filter
Inlet and outlet plenums for circular ducts (07 only)
Electromechanical sensor for automatic change over
Modbus communication board for Plologic
Other speeds configuration (standard factory set speeds in technical features table)
SRC - mini BMS controller
Suspension kit
Plologic controller (other electromechanical or electronic control systems also available)
TControl EASY 3S and TControl POD glass controllers (other electromechanical or electronic control systems also available)
WRC: wall-mounted remote control for Plologic

+ SEE PAGE 580 FOR MORE DETAILS ABOUT FAN COIL CONTROLLERS

## AC SELECT.

Smart and user-friendly the new air conditioning selection program: <https://acselect.panasonic.eu/>



## Technical features

Fan coil high static duct EC fan		P-FH7		P-FH15		P-FH18		P-FH21		P-FH24		P-FH27		
		3,33V/5,87V/8,67V <sup>1)</sup>		2V/4V/5V <sup>1)</sup>		2V/4V/5V <sup>1)</sup>		2V/4V/5V <sup>1)</sup>		2V/5V/7V <sup>1)</sup>		2V/5V/7V <sup>1)</sup>		
<b>2-pipes</b>														
Total cooling capacity <sup>2)</sup>	kW	3,26/4,90/5,88	7,93/10,1/11,1	8,98/11,7/12,8	9,79/12,7/13,9	10,6/16,1/17,6	11,7/18,1/19,9							
Sensible capacity <sup>2)</sup>	kW	2,05/3,59/4,56	6,08/8,05/8,9	6,71/9,02/10	7,14/9,55/10,60	7,84/12,4/13,7	8,43/13,6/15,1							
Water flow <sup>2)</sup>	l/h	562/844/1013	1369/1744/1917	1551/2020/2210	1690/2193/2400	1826/2780/3039	2022/3125/3436							
Water pressure drop <sup>2)</sup>	kPa	15/33,5/48,1	13,2/19,8/23	9,1/14,2/16,7	10,2/15,4/17,9	8,04/18,4/21,4	7,58/19,1/22,5							
Heating capacity <sup>3)</sup>	kW	2,47/5,61/9,26	8,66/11,7/13	9,48/13,1/14,6	9,99/14,1/15,8	10,9/17,6/19,5	11,6/19,1/21,4							
Water flow <sup>3)</sup>	l/h	425/966/1595	1495/2020/2245	1637/2262/2521	1725/2435/2728	1872/3039/3367	1993/3298/3695							
Water pressure drop <sup>3)</sup>	kPa	7,2/33,7/89,0	12,2/20,6/24,9	8,2/14,2/17,3	8,3/15/18,5	10,9/21,5/25,8	6,38/17,1/20,9							
<b>4-pipes</b>														
Total cooling capacity <sup>2)</sup>	kW	3,22/4,74/5,54	6,57/8,21/8,91	7,4/9,26/10	8,92/11,3/12,4	9,51/14/15,2	10,2/15,3/16,8							
Sensible capacity <sup>2)</sup>	kW	2,12/3,48/4,25	5,2/6,76/7,43	5,7/7,48/8,24	6,66/8,75/9,64	7,13/11/12,1	7,52/11,8/13,1							
Water flow <sup>2)</sup>	l/h	555/817/954	1134/1418/1538	1278/1599/1727	1540/1951/2141	1642/2417/2624	1761/2642/2901							
Water pressure drop <sup>2)</sup>	kPa	20,6/41,4/55,3	6,6/10,2/12	8/11,2/12,7	11,2/16,7/19,4	9,4/18,7/21,9	6,6/13,9/16,4							
Heating capacity <sup>4)</sup>	kW	3,93/6,81/9,05	5,85/7,45/8,13	10/12,9/14,2	10/11,9/14,2	8/11,9/13	7,71/11,7/12,9							
Water flow <sup>4)</sup>	l/h	338/586/779	505/643/702	863/1114/1226	863/1114/1226	691/1027/1122	666/1010/1114							
Water pressure drop <sup>4)</sup>	kPa	5,6/12,5/19,5	14,1/21,4/25	23/35/40,9	22,8/34,8/40,8	13,5/27,5/32,1	5,2/11,3/13,4							
<b>Sound levels</b>														
Sound power return - radiated <sup>5)</sup>	2-pipes	dB(A)	54/60/63	56/65/67	56/65/67	56/65/67	58/69/73	58/69/73						
	4-pipes	dB(A)	54/60/63	56/65/67	56/65/67	56/65/67	58/69/73	58/69/73						
Sound power - discharge <sup>5)</sup>	2-pipes	dB(A)	53/59/62	56/64/65	56/64/65	56/64/65	58/67/72	58/67/72						
	4-pipes	dB(A)	53/59/62	56/64/65	56/64/65	56/64/65	58/67/72	58/67/72						
Sound pressure <sup>6)</sup>	2-pipes	dB(A)	33/39/42	35/44/46	35/44/46	35/44/46	37/48/52	37/48/52						
	4-pipes	dB(A)	33/39/42	35/44/46	35/44/46	35/44/46	37/48/52	37/48/52						
NR <sup>6)</sup>	2-pipes		27/34/37	31/40/42	31/40/42	31/40/42	33/44/48	33/44/48						
	4-pipes		27/34/37	31/40/42	31/40/42	31/40/42	33/44/48	33/44/48						
<b>Ventilation</b>														
Number of fans			1	1	1	1	1	1	1	1	1	1	1	1
Filter			G3	G3	G3	G3	G3	G3	G3	G3	G3	G3	G3	G3
Air flow <sup>5)</sup>	2-pipes	m <sup>3</sup> /h	347/849/1293	1360/2044/2335	1360/2044/2335	1360/2044/2335	1519/2700/3098	1519/2700/3098						
	4-pipes	m <sup>3</sup> /h	320/803/1229	1360/2044/2335	1360/2044/2335	1360/2044/2335	1519/2700/3098	1519/2700/3098						
External static pressure	2-pipes	Pa	8/50/116	22/50/65	22/50/65	22/50/65	16/50/66	16/50/66						
	4-pipes	Pa	8/50/117	22/50/65	22/50/65	22/50/65	16/50/66	16/50/66						
<b>Electrical data</b>														
Power supply	Voltage	V	230	230	230	230	230	230	230	230	230	230	230	230
	Phase		Single phase	Single phase	Single phase	Single phase	Single phase	Single phase	Single phase	Single phase	Single phase	Single phase	Single phase	Single phase
	Frequency	Hz	50/60	50/60	50/60	50/60	50/60	50/60	50/60	50/60	50/60	50/60	50/60	50/60
Consumption	2-pipes	W	10/62/197	61/172/246	61/172/246	61/172/246	57/237/364	57/237/364						
	4-pipes	W	10/60/189	61/172/246	61/172/246	61/172/246	57/237/364	57/237/364						
Electric heater	W	2000	3000	3000	3000	3000	3000	3000	3000	3000	3000	3000	3000	3000
<b>Water connections</b>														
Connection type			Female gas threaded	Male gas threaded	Male gas threaded	Male gas threaded	Male gas threaded	Male gas threaded	Male gas threaded	Male gas threaded	Male gas threaded	Male gas threaded	Male gas threaded	Male gas threaded
2-pipes	Inch		½	1	1 ¼	1 ¼	1 ¼	1 ¼	1 ¼	1 ¼	1 ¼	1 ¼	1 ¼	1 ¼
	Cooling	Inch	½	1	1	1	1	1 ¼	1 ¼	1 ¼	1 ¼	1 ¼	1 ¼	1 ¼
4-pipes	Heating	Inch	½	¾	¾	¾	¾	¾	¾	¾	¾	¾	¾	¾
<b>Dimension and weight</b>														
Dimension	HxWxD	mm	250x1200x698	375x1380x798	375x1380x798	375x1380x798	450x1500x798	450x1500x798						
Weight		kg	42	63	65	67	76	80						

Energy efficiency class<sup>7)</sup>

Fan coil high static duct EC fan		FCEER		A to E		—		A		A		A		B		A	
2-pipes	FCCOP	A to E	—	A	A	A	A	B	A								
	FCCOP	A to E	—	A	A	A	A	A	A								
4-pipes	FCEER	A to E	—	B	B	A	A	A	A								
	FCCOP	A to E	—	B	A	A	A	B	B								

1) Fan standard factory set speeds (voltage). 2) According to Eurovent standard. Air: 27 °C DB/19 °C WB, chilled water: 7 °C/12 °C. 3) According to Eurovent standard. Air: 20 °C, hot water: 45 °C/40 °C. 4) According to Eurovent standard. Air: 20 °C, hot water: 65 °C/55 °C. 5) According to Eurovent 6/10 (air flow test method) and 8/12 (sound test method). 6) Informative data, considering an hypothetical sound attenuation of the room and installation of 9 dB(A). 7) According to Eurovent. \* Data with 1 configuration with rectangular return and discharge.



ErP compliant following COMMISSION REGULATION (EU) 2016/2281.



## Fan coil controllers

Panasonic has a wide, technological range of controllers and control systems suitable for installation within a wide variety of locations such as office, hotel, and residential applications. These controllers are compatible with AC and EC fans and allow users to take advantage of the improved performance and efficiency and thus energy savings. Most of our controllers have an intuitive user interface to easily setup the desired configurations.

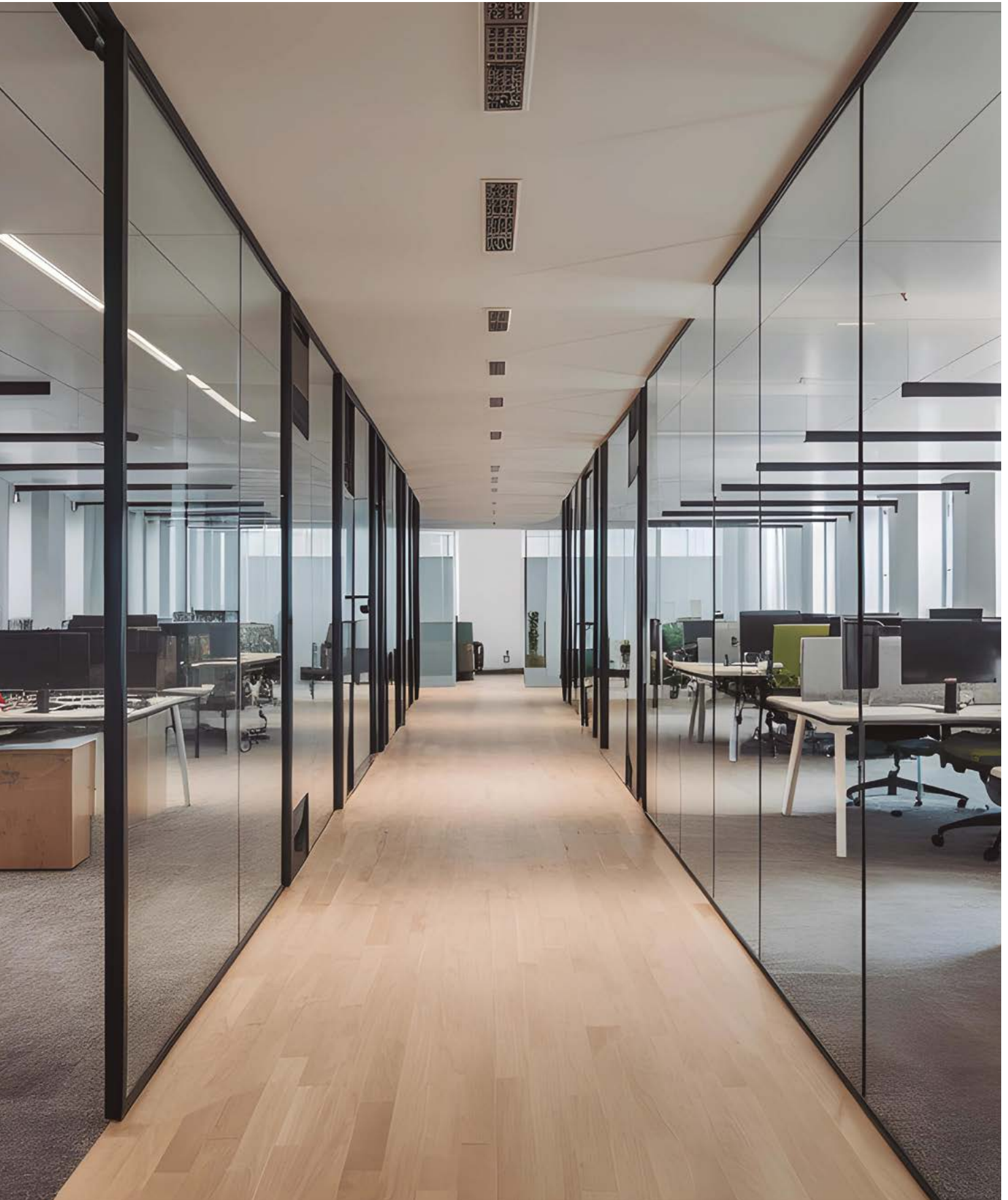

**1 Individual controllers**  
 Thanks to these controllers it is possible to control one fan coil unit individually. All our controllers fall into this category. Depending on the model, they can have different features: possibility to set the desired temperature, compatibility with AC and EC fans, LCD display, wall or unit mounting.

**2 Group controllers**  
 These controllers allow the control of more than one fan coil unit per controller but maintaining the same fan and temperature settings (a slight temperature variation is possible within the same zone). Plologic is the Panasonic group controller that allows you to control multiple units with a single control.

**3 Centralized and group controller**  
 Due to the advanced technical capability, it is possible to control different climatic zones with different settings and ambient conditions. The combination of Plologic + BMS and SRC are the perfect example for this type of control.

**Plologic (zone controller) with remote control.**

**1| Plologic. Different individual control possibilities.**

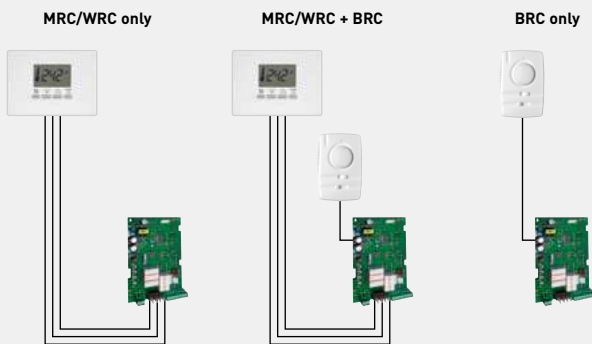

**2| Plologic. Group control (without BMS).**

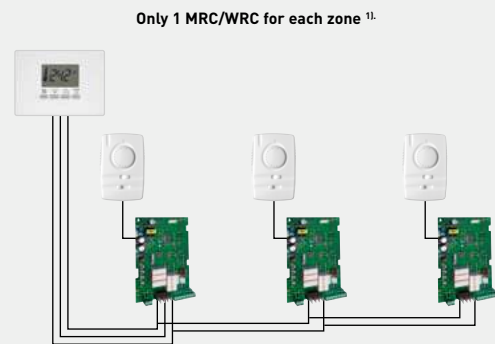

1) Up to 15 Plologic/fan coil units. Fan coil units can be of different types, with AC or EC fan motor.

**3| Centralized and group control with BMS and SRC.**

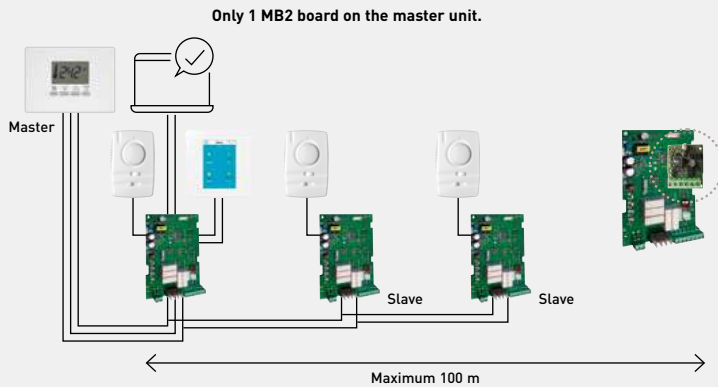

Only 1 MB2 board on the master unit.

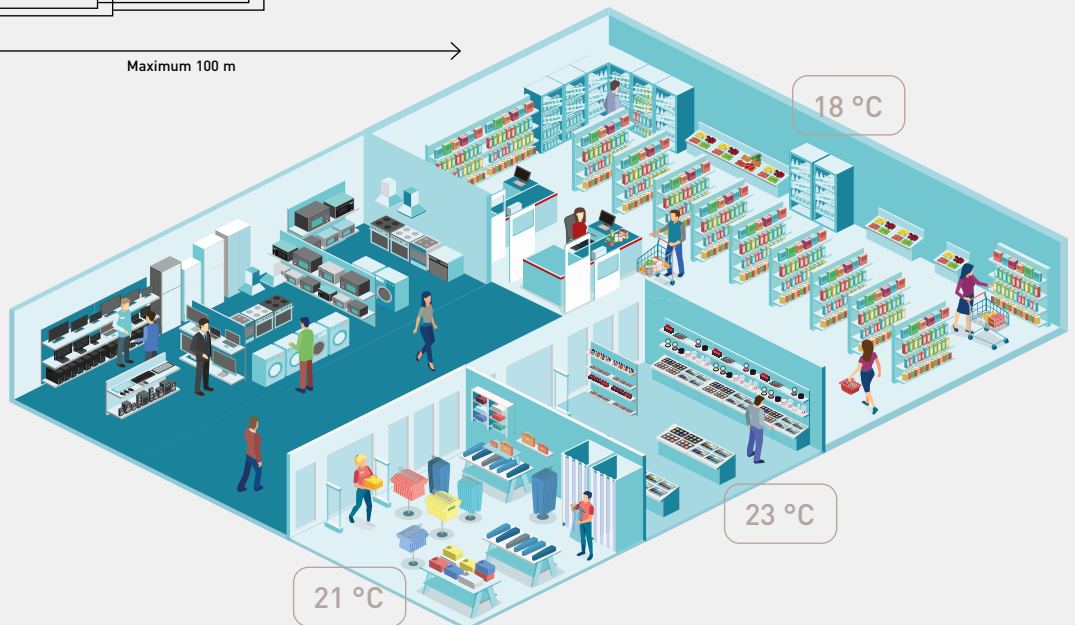

## Electro-mechanical and electronic control systems.



	TRM-FA	Plogic
2-pipes (cooling or heating)	✓	✓
2-pipes heat pump	✓	✓
2-pipes cooling + electric heater (≤ 2000 W)	✓	✓
2-pipes heat pump + electric heater (≤ 2000 W)	—	✓
4-pipes	✓	✓
Communication protocol	—	Modbus (with MB2 card)
SRC mini BMS compatibility	—	✓
<b>Functions</b>		
Changeover	Manual	Manual or Auto <sup>1)</sup>
Fan speed selection	Manual	Manual or Auto
Fan operation	Cyclic <sup>2)</sup>	Continuous <sup>3)</sup> or cyclic <sup>2)</sup>
Master/slave	—	✓ Up to 15 slave units
Time programming	—	—
<b>Fan compatibility</b>		
AC	✓	✓
EC with ecospeed card	✓	—
EC 0-10 V	—	✓
<b>Valve compatibility</b>		
ON / OFF 230 V	✓	✓
<b>Controller power supply</b>		
230 V	—	✓
<b>Mounting type</b>		
Wall-mounted or mounted on the unit	Wall	Unit

1) Changeover Auto with water pipe sensor. 2) Cyclic: fan stops when the set point is reached. 3) Continuous: fan continues running after the set point is reached.

## CONEX. Devices and apps\*.

CONEX provides comfort and control for varying user needs. Accessible, flexible and scalable with different controllers and apps.

\* Only available for fan coil wall FK1 models.



Model	Description
CZ-RTC6W	CONEX wired remote controller (non-wireless), white
CZ-RTC6WBL	CONEX wired remote controller with Bluetooth®, white
CZ-RTC6WBLW2	CONEX wired remote controller with Wi-Fi and Bluetooth®, white
CZ-RTC6	CONEX wired remote controller (non-wireless), black
CZ-RTC6BL	CONEX wired remote controller with Bluetooth®, black
CZ-RTC6BLW2	CONEX wired remote controller with Wi-Fi and Bluetooth®, black



Panasonic H&C Diagnosis App for service and installer.



Panasonic H&C Control App for end user, service and installer.



Comfort Cloud Panasonic Comfort Cloud App for end user.



TControl EASY 3S	TControl POD glass	PAW-FC-RC1	PAW-FC-903EC PAW-FC-907EC	PAW-FC-903AC PAW-FC-907AC
✓	✓	✓	✓	✓
✓	✓	—	—	—
—	✓	—	—	—
—	—	—	—	—
✓	✓	✓	✓	—
—	Modbus	Modbus	Modbus	—
—	✓	✓	✓	—
Manual or Auto <sup>1)</sup>	Manual or Auto <sup>1)</sup> or centralized	Manual or Auto	Manual	Manual
Manual or Auto	Manual or Auto	Manual or Auto	Manual or Auto	Manual or Auto
Continuous <sup>3)</sup> or cyclic <sup>2)</sup>	Continuous <sup>3)</sup> or cyclic <sup>2)</sup>	—	Continuous <sup>3)</sup> or cyclic <sup>2)</sup>	Continuous <sup>3)</sup> or cyclic <sup>2)</sup>
—	—	—	—	—
—	✓	—	—	—
✓	✓	✓	—	✓
✓	—	✓	—	—
—	✓	—	✓	—
✓	✓	✓	✓	✓
✓	✓	✓	✓	✓
Wall (surface or embedded)	Wall (surface or embedded)	Wall (embedded)	Wall (embedded)	Wall (embedded)

## Remote controls.

### Plogic.

Wall mounting (surface) or mounted on the unit.



WRC / MRC <sup>1)</sup>



BRC



IRC <sup>1)</sup>

<sup>1)</sup> Integrated temperature sensor.

## SRC - mini BMS controller.

Smart controller. Mini building management system.





- Can be used as a mini BMS or a remote control
- Manage up to 15 zones and 31 units
- Communicate via Modbus protocol
- Time programming function

Note: Electrical heaters maximum power may vary according to the controller without a relay.

# Accessories and control - Aquarea Air Smart fan coils

## Aquarea Air Smart fan coil floor standing accessories

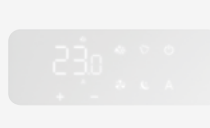
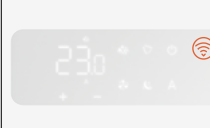
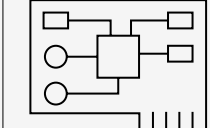

### Control accessories

 <p><b>Wall-mounted control with Modbus for Aquarea Air Smart fan coils.</b></p> <p>-----</p> <p>PCZ-EEB749</p>	 <p><b>Wall-mounted control with Integrated Wi-Fi for Aquarea Air Smart fan coils.</b></p> <p>-----</p> <p>PCZ-EFB749</p>	 <p><b>Wall-mounted control PCB for Aquarea Air Smart fan coil floor standing.</b></p> <p>-----</p> <p>PCZ-ESE845</p>	 <p><b>On-board display with Modbus for Aquarea Air Smart fan coil floor standing.</b></p> <p>-----</p> <p>PCZ-ECA844</p>	 <p><b>On-board display with integrated Wi-Fi for Aquarea Air Smart fan coil floor standing.</b></p> <p>-----</p> <p>PCZ-EWA844</p>	 <p><b>PCB for analog control (0-10V) for Aquarea Air Smart fan coils Floor standing.</b></p> <p>-----</p> <p>PCZ-B10842</p>
---	--	--	--	--	---

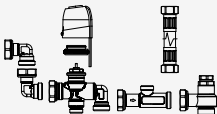
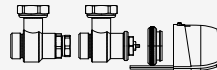
### Hydraulic accessories

 <p><b>Motorised 3 way valve for Aquarea Air floor standing.</b></p> <p>-----</p> <p>PCZ-V30720</p>	 <p><b>Motorised 2 way valve for Aquarea Air floor standing, wall-mounted 40 and ducted.</b></p> <p>-----</p> <p>PCZ-V20139</p>
--	--

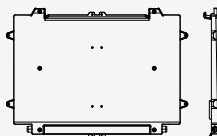
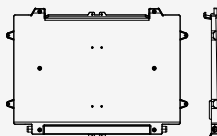
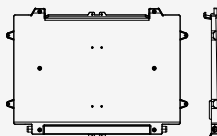
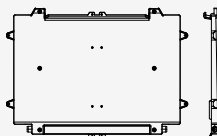

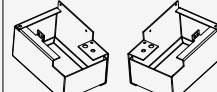
### Installation accessories

 <p><b>Condensate drip tray for horizontal installation of the Aquarea Air Smart fan coil floor standing 10.</b></p> <p>-----</p> <p>PCZ-GB0520</p>	 <p><b>Condensate drip tray for horizontal installation of the Aquarea Air Smart fan coil floor standing 20.</b></p> <p>-----</p> <p>PCZ-GB0521</p>	 <p><b>Condensate drip tray for horizontal installation of the Aquarea Air Smart fan coil floor standing 30.</b></p> <p>-----</p> <p>PCZ-GB0522</p>	 <p><b>Condensate drip tray for horizontal installation of the Aquarea Air Smart fan coil floor standing 35.</b></p> <p>-----</p> <p>PCZ-GB0523</p>	 <p><b>Set of 2 legs to protect water pipes for Aquarea Air floor standing.</b></p> <p>-----</p> <p>PCZ-LC0158</p>	 <p><b>Set of 2 legs to anchor the Aquarea Air floor standing to the floor.</b></p> <p>-----</p> <p>PCZ-LC0606</p>
<p><b>Condensate drip tray for horizontal installation of the Aquarea Air Smart fan coil floor standing 40.</b></p> <p>-----</p> <p>PCZ-GB0524</p>					

## Aquarea Air Smart fan coil wall-mounted accessories

### Control accessories



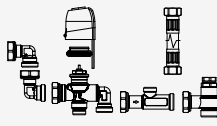
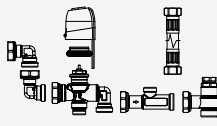
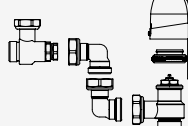
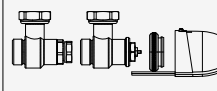

### Hydraulic accessories

 <p><b>Wall-mounted control with Modbus for Aquarea Air Smart fan coils.</b></p> <p>-----</p> <p>PCZ-EEB749</p>	 <p><b>Wall-mounted control with Integrated Wi-Fi for Aquarea Air Smart fan coils.</b></p> <p>-----</p> <p>PCZ-EFB749</p>	 <p><b>Motorised 3 way valve for Aquarea Air wall-mounted 10, 15 and 20.</b></p> <p>-----</p> <p>PCZ-V30688</p>	 <p><b>Motorised 3 way valve for Aquarea Air wall-mounted 40.</b></p> <p>-----</p> <p>PCZ-V30718</p>	 <p><b>Motorised 2 way valve for Aquarea Air wall-mounted 10, 15 and 20.</b></p> <p>-----</p> <p>PCZ-V20687</p>	 <p><b>Motorised 2 way valve for Aquarea Air floor standing, wall-mounted 40 and ducted.</b></p> <p>-----</p> <p>PCZ-V20139</p>
---	--	--	---	--	--

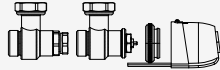
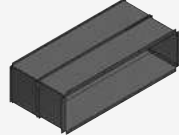



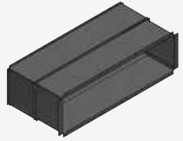



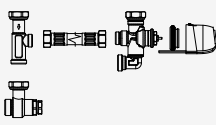
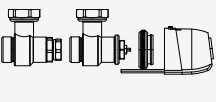

Aquarea Air Smart fan coil ducted thin accessories

Control accessories			Hydraulic accessories				
 <p><b>Wall-mounted control with Modbus for Aquarea Air Smart fan coils.</b></p> <p>-----</p> <p>PCZ-EEB749</p>		 <p><b>Wall-mounted control with Integrated Wi-Fi for Aquarea Air Smart fan coils.</b></p> <p>-----</p> <p>PCZ-EFB749</p>		 <p><b>Motorised 3 way valve for Aquarea Air ducted.</b></p> <p>-----</p> <p>PCZ-V30361</p>		 <p><b>Motorised 2 way valve for Aquarea Air floor standing, wall-mounted 40 and ducted.</b></p> <p>-----</p> <p>PCZ-V20139</p>	
Replacement filter kit	Delivery plates	Return plenum	90° shooting plenum	Telescopic kit	Grille for telescopic kit		
 <p><b>Replacement recirculation filter kit. For P-FSN20 and P-FTN15.</b></p> <p>-----</p> <p>PCZ-AHRD0491</p>	 <p><b>Delivery plate with 2 circular inlets DN 160 mm. For P-FTN15.</b></p> <p>-----</p> <p>PCZ-AHRD0561</p>	 <p><b>Return plenum with 2 circular inlets DN 160 mm. For P-FTN15.</b></p> <p>-----</p> <p>PCZ-AHRD0566</p>	 <p><b>90° shooting plenum. For P-FTN15.</b></p> <p>-----</p> <p>PCZ-AHRD0576</p>	 <p><b>Telescopic kit for rear or directly coupled suction. 153 mm - 270 mm. For P-FTN15.</b></p> <p>-----</p> <p>PCZ-AHRD0581</p>	 <p><b>Grille for telescopic kit for rear intake. For P-FTN15.</b></p> <p>-----</p> <p>PCZ-AHRD0586</p>		
<p><b>Replacement recirculation filter kit. For P-FSN25, P-FTN20, P-FSQ30 and P-FTQ30.</b></p> <p>-----</p> <p>PCZ-AHRD0492</p>	<p><b>Delivery plate with 3 circular inlets DN 160 mm. For P-FTN20.</b></p> <p>-----</p> <p>PCZ-AHRD0562</p>	<p><b>Return plenum with 3 circular inlets DN 160 mm. For P-FTN20.</b></p> <p>-----</p> <p>PCZ-AHRD0567</p>	<p><b>90° shooting plenum. For P-FTN20 and P-FTQ30.</b></p> <p>-----</p> <p>PCZ-AHRD0577</p>	<p><b>Telescopic kit for rear or directly coupled suction. 153 mm - 270 mm. For P-FTN20.</b></p> <p>-----</p> <p>PCZ-AHRD0582</p>	<p><b>Grille for telescopic kit for rear intake. For P-FTN20.</b></p> <p>-----</p> <p>PCZ-AHRD0587</p>		
<p><b>Replacement recirculation filter kit. For P-FSN35, P-FTN25, P-FSQ45 and P-FTQ45.</b></p> <p>-----</p> <p>PCZ-AHRD0493</p>	<p><b>Delivery plate with 4 circular inlets DN 160 mm. For P-FTN25.</b></p> <p>-----</p> <p>PCZ-AHRD0563</p>	<p><b>Return plenum with 4 circular inlets DN 160 mm. For P-FTN25.</b></p> <p>-----</p> <p>PCZ-AHRD0568</p>	<p><b>90° shooting plenum. For P-FTN25 and P-FTQ45.</b></p> <p>-----</p> <p>PCZ-AHRD0578</p>	<p><b>Telescopic kit for rear or directly coupled suction. 153 mm - 270 mm. For P-FTN25.</b></p> <p>-----</p> <p>PCZ-AHRD0583</p>	<p><b>Grille for telescopic kit for rear intake. For P-FTN25.</b></p> <p>-----</p> <p>PCZ-AHRD0588</p>		
<p><b>Replacement recirculation filter kit. For P-FSN45, P-FTN35, P-FSQ60 and P-FTQ60.</b></p> <p>-----</p> <p>PCZ-AHRD0494</p>	<p><b>Delivery plate with 6 circular inlets DN 160 mm. For P-FTN35.</b></p> <p>-----</p> <p>PCZ-AHRD0564</p>	<p><b>Return plenum with 6 circular inlets DN 160 mm. For P-FTN35.</b></p> <p>-----</p> <p>PCZ-AHRD0569</p>	<p><b>90° shooting plenum. For P-FTN35 and P-FTQ60.</b></p> <p>-----</p> <p>PCZ-AHRD0579</p>	<p><b>Telescopic kit for rear or directly coupled suction. 153 mm - 270 mm. For P-FTN35.</b></p> <p>-----</p> <p>PCZ-AHRD0584</p>	<p><b>Grille for telescopic kit for rear intake. For P-FTN35.</b></p> <p>-----</p> <p>PCZ-AHRD0589</p>		
<p><b>Replacement recirculation filter kit. For P-FSN55, P-FTN45, P-FSQ75 and P-FTQ65.</b></p> <p>-----</p> <p>PCZ-AHRD0495</p>	<p><b>Delivery plate with 7 circular inlets DN 160 mm. For P-FTN45.</b></p> <p>-----</p> <p>PCZ-AHRD0565</p>	<p><b>Return plenum with 7 circular inlets DN 160 mm. For P-FTN45.</b></p> <p>-----</p> <p>PCZ-AHRD0570</p>	<p><b>90° shooting plenum. For P-FTN45 and P-FTQ65.</b></p> <p>-----</p> <p>PCZ-AHRD0580</p>	<p><b>Telescopic kit for rear or directly coupled suction. 153 mm - 270 mm. For P-FTN45.</b></p> <p>-----</p> <p>PCZ-AHRD0585</p>	<p><b>Grille for telescopic kit for rear intake. For P-FTN45.</b></p> <p>-----</p> <p>PCZ-AHRD0590</p>		

Outdoor air kit	Ducting plate outdoor air kit	90° plenum for outdoor air kit with damper	Telescopic kit for outdoor air kit	Grille for telescopic kit for outdoor air kit
 <p>Plenum kit for external air connection with damper for room recirculation. For P-FTN15.</p> <p>-----</p> <p>PCZ-AHRD0571</p>	 <p>Ducting plate plenum kit for outdoor air connection with damper. For P-FTN15.</p> <p>-----</p> <p>PCZ-AHRD0611</p>	 <p>90° plenum for outdoor air kit with damper. For P-FTN15.</p> <p>-----</p> <p>PCZ-AHRD0616</p>	 <p>Telescopic kit. For plenum for outdoor air kit with damper. For P-FTN15.</p> <p>-----</p> <p>PCZ-AHRD0621</p>	 <p>Grille for telescopic kit. For plenum for outdoor air kit with damper. For P-FTN15.</p> <p>-----</p> <p>PCZ-AHRD0626</p>
<p>Plenum kit for external air connection with damper for room recirculation. For P-FTN20 and P-FTQ30.</p> <p>-----</p> <p>PCZ-AHRD0572</p>	<p>Ducting plate plenum kit for outdoor air connection with damper. For P-FTN20 and P-FTQ30.</p> <p>-----</p> <p>PCZ-AHRD0612</p>	<p>90° plenum for outdoor air kit with damper. For P-FTN20 and P-FTQ30.</p> <p>-----</p> <p>PCZ-AHRD0617</p>	<p>Telescopic kit. For plenum for outdoor air kit with damper. For P-FTN20 and P-FTQ30.</p> <p>-----</p> <p>PCZ-AHRD0622</p>	<p>Grille for telescopic kit. For plenum for outdoor air kit with damper. For P-FTN20 and P-FTQ30.</p> <p>-----</p> <p>PCZ-AHRD0627</p>
<p>Plenum kit for external air connection with damper for room recirculation. For P-FTN25 and P-FTQ45.</p> <p>-----</p> <p>PCZ-AHRD0573</p>	<p>Ducting plate plenum kit for outdoor air connection with damper. For P-FTN25 and P-FTQ45.</p> <p>-----</p> <p>PCZ-AHRD0613</p>	<p>90° plenum for outdoor air kit with damper. For P-FTN25 and P-FTQ45.</p> <p>-----</p> <p>PCZ-AHRD0618</p>	<p>Telescopic kit. For plenum for outdoor air kit with damper. For P-FTN25 and P-FTQ45.</p> <p>-----</p> <p>PCZ-AHRD0623</p>	<p>Grille for telescopic kit. For plenum for outdoor air kit with damper. For P-FTN25 and P-FTQ45.</p> <p>-----</p> <p>PCZ-AHRD0628</p>
<p>Plenum kit for external air connection with damper for room recirculation. For P-FTN35 and P-FTQ60.</p> <p>-----</p> <p>PCZ-AHRD0574</p>	<p>Ducting plate plenum kit for outdoor air connection with damper. For P-FTN35 and P-FTQ60.</p> <p>-----</p> <p>PCZ-AHRD0614</p>	<p>90° plenum for outdoor air kit with damper. For P-FTN35 and P-FTQ60.</p> <p>-----</p> <p>PCZ-AHRD0619</p>	<p>Telescopic kit. For plenum for outdoor air kit with damper. For P-FTN35 and P-FTQ60.</p> <p>-----</p> <p>PCZ-AHRD0624</p>	<p>Grille for telescopic kit. For plenum for outdoor air kit with damper. For P-FTN35 and P-FTQ60.</p> <p>-----</p> <p>PCZ-AHRD0629</p>
<p>Plenum kit for external air connection with damper for room recirculation. For P-FTN45 and P-FTQ65.</p> <p>-----</p> <p>PCZ-AHRD0575</p>	<p>Ducting plate plenum kit for outdoor air connection with damper. For P-FTN45 and P-FTQ65.</p> <p>-----</p> <p>PCZ-AHRD0615</p>	<p>90° plenum for outdoor air kit with damper. For P-FTN45 and P-FTQ65.</p> <p>-----</p> <p>PCZ-AHRD0620</p>	<p>Telescopic kit. For plenum for outdoor air kit with damper. For P-FTN45 and P-FTQ65.</p> <p>-----</p> <p>PCZ-AHRD0625</p>	<p>Grille for telescopic kit. For plenum for outdoor air kit with damper. For P-FTN45 and P-FTQ65.</p> <p>-----</p> <p>PCZ-AHRD0630</p>

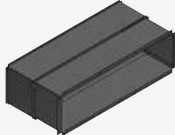

### Aquarea Air Smart fan coil ducted accessories

Control accessories		Hydraulic accessories	
 <p>Wall-mounted control with Modbus for Aquarea Air Smart fan coils.</p> <p>-----</p> <p>PCZ-EEB749</p>	 <p>Wall-mounted control with Integrated Wi-Fi for Aquarea Air Smart fan coils.</p> <p>-----</p> <p>PCZ-EEB749</p>	 <p>Motorised 3 way valve for Aquarea Air ducted.</p> <p>-----</p> <p>PCZ-V30361</p>	 <p>Motorised 2 way valve for Aquarea Air floor standing, wall-mounted 40 and ducted.</p> <p>-----</p> <p>PCZ-V20139</p>

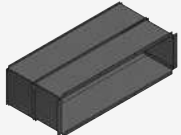
Replacement filter kit	Delivery plates	Return plenum	90° shooting plenum	Telescopic kit	Grille for telescopic kit
 <p>Replacement recirculation filter kit. For P-FSN20 and P-FTN15.</p> <p>-----</p> <p>PCZ-AHRD0491</p>	 <p>Delivery plate with 2 circular inlets DN 160 mm. For P-FSN20.</p> <p>-----</p> <p>PCZ-AHRD0431</p>	 <p>Return plenum with 2 circular inlets DN 160 mm. For P-FSN20.</p> <p>-----</p> <p>PCZ-AHRD0461</p>	 <p>90° shooting plenum. For P-FSN20.</p> <p>-----</p> <p>PCZ-AHRD0521</p>	 <p>Telescopic kit for rear or directly coupled suction. 153 mm - 270 mm. For P-FSN20.</p> <p>-----</p> <p>PCZ-AHRD0531</p>	 <p>Grille for telescopic kit for rear intake. For P-FSN20.</p> <p>-----</p> <p>PCZ-AHRD0541</p>
<p>Replacement recirculation filter kit. For P-FSN25, P-FTN20, P-FSQ30 and P-FTQ30.</p> <p>-----</p> <p>PCZ-AHRD0492</p>	<p>Delivery plate with 3 circular inlets DN 160 mm. For P-FSN25.</p> <p>-----</p> <p>PCZ-AHRD0432</p>	<p>Return plenum with 3 circular inlets DN 160 mm. For P-FSN25.</p> <p>-----</p> <p>PCZ-AHRD0462</p>	<p>90° shooting plenum. For P-FSN25 and P-FSQ30.</p> <p>-----</p> <p>PCZ-AHRD0522</p>	<p>Telescopic kit for rear or directly coupled suction. 153 mm - 270 mm. For P-FSN25.</p> <p>-----</p> <p>PCZ-AHRD0532</p>	<p>Grille for telescopic kit for rear intake. For P-FSN25.</p> <p>-----</p> <p>PCZ-AHRD0542</p>
<p>Replacement recirculation filter kit. For P-FSN35, P-FTN25, P-FSQ45 and P-FTQ45.</p> <p>-----</p> <p>PCZ-AHRD0493</p>	<p>Delivery plate with 4 circular inlets DN 160 mm. For P-FSN35.</p> <p>-----</p> <p>PCZ-AHRD0433</p>	<p>Return plenum with 4 circular inlets DN 160 mm. For P-FSN35.</p> <p>-----</p> <p>PCZ-AHRD0463</p>	<p>90° shooting plenum. For P-FSN35 and P-FSQ45.</p> <p>-----</p> <p>PCZ-AHRD0523</p>	<p>Telescopic kit for rear or directly coupled suction. 153 mm - 270 mm. For P-FSN35.</p> <p>-----</p> <p>PCZ-AHRD0533</p>	<p>Grille for telescopic kit for rear intake. For P-FSN35.</p> <p>-----</p> <p>PCZ-AHRD0543</p>
<p>Replacement recirculation filter kit. For P-FSN45, P-FTN35, P-FSQ60 and P-FTQ60.</p> <p>-----</p> <p>PCZ-AHRD0494</p>	<p>Delivery plate with 6 circular inlets DN 160 mm. For P-FSN45.</p> <p>-----</p> <p>PCZ-AHRD0434</p>	<p>Return plenum with 6 circular inlets DN 160 mm. For P-FSN45.</p> <p>-----</p> <p>PCZ-AHRD0464</p>	<p>90° shooting plenum. For P-FSN45 and P-FSQ60.</p> <p>-----</p> <p>PCZ-AHRD0524</p>	<p>Telescopic kit for rear or directly coupled suction. 153 mm - 270 mm. For P-FSN45.</p> <p>-----</p> <p>PCZ-AHRD0534</p>	<p>Grille for telescopic kit for rear intake. For P-FSN45.</p> <p>-----</p> <p>PCZ-AHRD0544</p>
<p>Replacement recirculation filter kit. For P-FSN55, P-FTN45, P-FSQ75 and P-FTQ65.</p> <p>-----</p> <p>PCZ-AHRD0495</p>	<p>Delivery plate with 7 circular inlets DN 160 mm. For P-FSN55.</p> <p>-----</p> <p>PCZ-AHRD0435</p>	<p>Return plenum with 7 circular inlets DN 160 mm. For P-FSN55.</p> <p>-----</p> <p>PCZ-AHRD0465</p>	<p>90° shooting plenum. For P-FSN55 and P-FSQ75.</p> <p>-----</p> <p>PCZ-AHRD0525</p>	<p>Telescopic kit for rear or directly coupled suction. 153 mm - 270 mm. For P-FSN55.</p> <p>-----</p> <p>PCZ-AHRD0535</p>	<p>Grille for telescopic kit for rear intake. For P-FSN55.</p> <p>-----</p> <p>PCZ-AHRD0545</p>

Outdoor air kit	Ducting plate outdoor air kit	90° plenum for outdoor air kit with damper	Telescopic kit for outdoor air kit	Grille for telescopic kit for outdoor air kit
 Plenum kit for external air connection with damper for room recirculation. For P-FSN20. ----- PCZ-AHRD0639	 Ducting plate plenum kit for outdoor air connection with damper. For P-FSN20. ----- PCZ-AHRD0651	 90° plenum for outdoor air kit with damper. For P-FSN20. ----- PCZ-AHRD0656	 Telescopic kit. For plenum for outdoor air kit with damper. For P-FSN20. ----- PCZ-AHRD0661	 Grille for telescopic kit. For plenum for outdoor air kit with damper. For P-FSN20. ----- PCZ-AHRD0666
Plenum kit for external air connection with damper for room recirculation. For P-FSN25 and P-FSQ30. ----- PCZ-AHRD0640	Ducting plate plenum kit for outdoor air connection with damper. For P-FSN25 and P-FSQ30. ----- PCZ-AHRD0652	90° plenum for outdoor air kit with damper. For P-FSN25 and P-FSQ30. ----- PCZ-AHRD0657	Telescopic kit. For plenum for outdoor air kit with damper. For P-FSN25 and P-FSQ30. ----- PCZ-AHRD0662	Grille for telescopic kit. For plenum for outdoor air kit with damper. For P-FSN25 and P-FSQ30. ----- PCZ-AHRD0667
Plenum kit for external air connection with damper for room recirculation. For P-FSN35 and P-FSQ45. ----- PCZ-AHRD0641	Ducting plate plenum kit for outdoor air connection with damper. For P-FSN35 and P-FSQ45. ----- PCZ-AHRD0653	90° plenum for outdoor air kit with damper. For P-FSN35 and P-FSQ45. ----- PCZ-AHRD0658	Telescopic kit. For plenum for outdoor air kit with damper. For P-FSN35 and P-FSQ45. ----- PCZ-AHRD0663	Grille for telescopic kit. For plenum for outdoor air kit with damper. For P-FSN35 and P-FSQ45. ----- PCZ-AHRD0668
Plenum kit for external air connection with damper for room recirculation. For P-FSN45 and P-FSQ60. ----- PCZ-AHRD0642	Ducting plate plenum kit for outdoor air connection with damper. For P-FSN45 and P-FSQ60. ----- PCZ-AHRD0654	90° plenum for outdoor air kit with damper. For P-FSN45 and P-FSQ60. ----- PCZ-AHRD0659	Telescopic kit. For plenum for outdoor air kit with damper. For P-FSN45 and P-FSQ60. ----- PCZ-AHRD0664	Grille for telescopic kit. For plenum for outdoor air kit with damper. For P-FSN45 and P-FSQ60. ----- PCZ-AHRD0669
Plenum kit for external air connection with damper for room recirculation. For P-FSN55 and P-FSQ75. ----- PCZ-AHRD0643	Ducting plate plenum kit for outdoor air connection with damper. For P-FSN55 and P-FSQ75. ----- PCZ-AHRD0655	90° plenum for outdoor air kit with damper. For P-FSN55 and P-FSQ75. ----- PCZ-AHRD0660	Telescopic kit. For plenum for outdoor air kit with damper. For P-FSN55 and P-FSQ75. ----- PCZ-AHRD0665	Grille for telescopic kit. For plenum for outdoor air kit with damper. For P-FSN55 and P-FSQ75. ----- PCZ-AHRD0670

**Aquarea Air Smart fan coil ducted multi zone thin accessories**

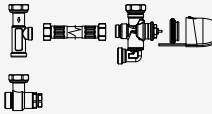
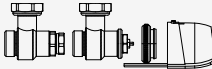
Control accessories		Hydraulic accessories	
 Wall-mounted control with Modbus for Aquarea Air Smart fan coils. ----- PCZ-EEB749	 Wall-mounted control with Integrated Wi-Fi for Aquarea Air Smart fan coils. ----- PCZ-EEB749	 Motorised 3 way valve for Aquarea Air ducted. ----- PCZ-V30361	 Motorised 2 way valve for Aquarea Air floor standing, wall-mounted 40 and ducted. ----- PCZ-V20139

Replacement filter kit	Return plenum	90° shooting plenum	Outdoor air kit
 <p>Replacement recirculation filter kit. For P-FSN25, P-FTN20, P-FSQ30 and P-FTQ30.</p> <p>----- PCZ-AHRD0492</p> <p>Replacement recirculation filter kit. For P-FSN35, P-FTN25, P-FSQ45 and P-FTQ45.</p> <p>----- PCZ-AHRD0493</p> <p>Replacement recirculation filter kit. For P-FSN45, P-FTN35, P-FSQ60 and P-FTQ60.</p> <p>----- PCZ-AHRD0494</p> <p>Replacement recirculation filter kit. For P-FSN55, P-FTN45, P-FSQ75 and P-FTQ65.</p> <p>----- PCZ-AHRD0495</p>	 <p>Return plenum with 2 circular inlets DN 160 mm. For P-FTQ30.</p> <p>----- PCZ-AHRD0682</p>  <p>Return plenum with 3 circular inlets DN 160 mm. For P-FTQ45.</p> <p>----- PCZ-AHRD0683</p>  <p>Return plenum with 4 circular inlets DN 160 mm. For P-FTQ60.</p> <p>----- PCZ-AHRD0684</p>  <p>Return plenum with 5 circular inlets DN 160 mm. For P-FTQ65.</p> <p>----- PCZ-AHRD0685</p>	 <p>90° shooting plenum. For P-FTN20 and P-FTQ30.</p> <p>----- PCZ-AHRD0577</p>  <p>90° shooting plenum. For P-FTN25 and P-FTQ45.</p> <p>----- PCZ-AHRD0578</p>  <p>90° shooting plenum. For P-FTN35 and P-FTQ60.</p> <p>----- PCZ-AHRD0579</p>  <p>90° shooting plenum. For P-FTN45 and P-FTQ65.</p> <p>----- PCZ-AHRD0580</p>	 <p>Plenum kit for external air connection with damper for room recirculation. For P-FTN20 and P-FTQ30.</p> <p>----- PCZ-AHRD0572</p>  <p>Plenum kit for external air connection with damper for room recirculation. For P-FTN25 and P-FTQ45.</p> <p>----- PCZ-AHRD0573</p>  <p>Plenum kit for external air connection with damper for room recirculation. For P-FTN35 and P-FTQ60.</p> <p>----- PCZ-AHRD0574</p>  <p>Plenum kit for external air connection with damper for room recirculation. For P-FTN45 and P-FTQ65.</p> <p>----- PCZ-AHRD0575</p>
<p>Ducting plate outdoor air kit</p>	<p>90° plenum for outdoor air kit with damper</p>	<p>Telescopic kit for outdoor air kit</p>	<p>Grille for telescopic kit for outdoor air kit</p>
 <p>Ducting plate plenum kit for outdoor air connection with damper. For P-FTN20 and P-FTQ30.</p> <p>----- PCZ-AHRD0612</p> <p>Ducting plate plenum kit for outdoor air connection with damper. For P-FTN25 and P-FTQ45.</p> <p>----- PCZ-AHRD0613</p> <p>Ducting plate plenum kit for outdoor air connection with damper. For P-FTN35 and P-FTQ60.</p> <p>----- PCZ-AHRD0614</p> <p>Ducting plate plenum kit for outdoor air connection with damper. For P-FTN45 and P-FTQ65.</p> <p>----- PCZ-AHRD0615</p>	 <p>90° plenum for outdoor air kit with damper. For P-FTN20 and P-FTQ30.</p> <p>----- PCZ-AHRD0617</p>  <p>90° plenum for outdoor air kit with damper. For P-FTN25 and P-FTQ45.</p> <p>----- PCZ-AHRD0618</p>  <p>90° plenum for outdoor air kit with damper. For P-FTN35 and P-FTQ60.</p> <p>----- PCZ-AHRD0619</p>  <p>90° plenum for outdoor air kit with damper. For P-FTN45 and P-FTQ65.</p> <p>----- PCZ-AHRD0620</p>	 <p>Telescopic kit. For plenum for outdoor air kit with damper. For P-FTN20 and P-FTQ30.</p> <p>----- PCZ-AHRD0622</p>  <p>Telescopic kit. For plenum for outdoor air kit with damper. For P-FTN25 and P-FTQ45.</p> <p>----- PCZ-AHRD0623</p>  <p>Telescopic kit. For plenum for outdoor air kit with damper. For P-FTN35 and P-FTQ60.</p> <p>----- PCZ-AHRD0624</p>  <p>Telescopic kit. For plenum for outdoor air kit with damper. For P-FTN45 and P-FTQ65.</p> <p>----- PCZ-AHRD0625</p>	 <p>Grille for telescopic kit. For plenum for outdoor air kit with damper. For P-FTN20 and P-FTQ30.</p> <p>----- PCZ-AHRD0627</p>  <p>Grille for telescopic kit. For plenum for outdoor air kit with damper. For P-FTN25 and P-FTQ45.</p> <p>----- PCZ-AHRD0628</p>  <p>Grille for telescopic kit. For plenum for outdoor air kit with damper. For P-FTN35 and P-FTQ60.</p> <p>----- PCZ-AHRD0629</p>  <p>Grille for telescopic kit. For plenum for outdoor air kit with damper. For P-FTN45 and P-FTQ65.</p> <p>----- PCZ-AHRD0630</p>







Non-return damper



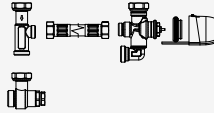
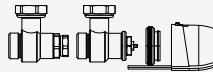

Non-return damper for P-FTQ and P-FSQ.

PCZ-AHRD0519

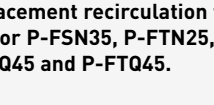
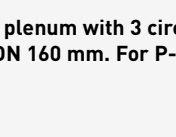
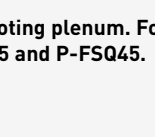
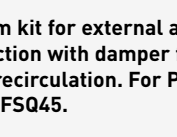
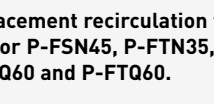
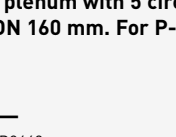
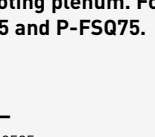
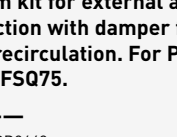
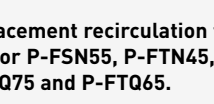
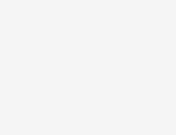
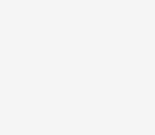
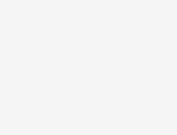
Aquarea Air Smart fan coil ducted multi zone accessories

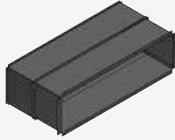
Control accessories		Hydraulic accessories	
 <p><b>Wall-mounted control with Modbus for Aquarea Air Smart fan coils.</b></p> <p>PCZ-EEB749</p>	 <p><b>Wall-mounted control with Integrated Wi-Fi for Aquarea Air Smart fan coils.</b></p> <p>PCZ-EFB749</p>	 <p><b>Motorised 3 way valve for Aquarea Air ducted.</b></p> <p>PCZ-V30361</p>	 <p><b>Motorised 2 way valve for Aquarea Air floor standing, wall-mounted 40 and ducted.</b></p> <p>PCZ-V20139</p>
Replacement filter kit	Return plenum	90° shooting plenum	Outdoor air kit
 <p><b>Replacement recirculation filter kit. For P-FSN25, P-FTN20, P-FSQ30 and P-FTQ30.</b></p> <p>PCZ-AHRD0492</p>	 <p><b>Return plenum with 2 circular inlets DN 160 mm. For P-FSQ30.</b></p> <p>PCZ-AHRD0466</p>	 <p><b>90° shooting plenum. For P-FSN25 and P-FSQ30.</b></p> <p>PCZ-AHRD0522</p>	 <p><b>Plenum kit for external air connection with damper for room recirculation. For P-FSN25 and P-FSQ30.</b></p> <p>PCZ-AHRD0640</p>
 <p><b>Replacement recirculation filter kit. For P-FSN35, P-FTN25, P-FSQ45 and P-FTQ45.</b></p> <p>PCZ-AHRD0493</p>	 <p><b>Return plenum with 3 circular inlets DN 160 mm. For P-FSQ45.</b></p> <p>PCZ-AHRD0467</p>	 <p><b>90° shooting plenum. For P-FSN35 and P-FSQ45.</b></p> <p>PCZ-AHRD0523</p>	 <p><b>Plenum kit for external air connection with damper for room recirculation. For P-FSN35 and P-FSQ45.</b></p> <p>PCZ-AHRD0641</p>
 <p><b>Replacement recirculation filter kit. For P-FSN45, P-FTN35, P-FSQ60 and P-FTQ60.</b></p> <p>PCZ-AHRD0494</p>	 <p><b>Return plenum with 4 circular inlets DN 160 mm. For P-FSQ60.</b></p> <p>PCZ-AHRD0468</p>	 <p><b>90° shooting plenum. For P-FSN45 and P-FSQ60.</b></p> <p>PCZ-AHRD0524</p>	 <p><b>Plenum kit for external air connection with damper for room recirculation. For P-FSN45 and P-FSQ60.</b></p> <p>PCZ-AHRD0642</p>
 <p><b>Replacement recirculation filter kit. For P-FSN55, P-FTN45, P-FSQ75 and P-FTQ65.</b></p> <p>PCZ-AHRD0495</p>	 <p><b>Return plenum with 5 circular inlets DN 160 mm. For P-FSQ75.</b></p> <p>PCZ-AHRD0469</p>	 <p><b>90° shooting plenum. For P-FSN55 and P-FSQ75.</b></p> <p>PCZ-AHRD0525</p>	 <p><b>Plenum kit for external air connection with damper for room recirculation. For P-FSN55 and P-FSQ75.</b></p> <p>PCZ-AHRD0643</p>

90° plenum for outdoor air kit with damper	Telescopic kit for outdoor air kit	Grille for telescopic kit for outdoor air kit
 <p><b>90° plenum for outdoor air kit with damper. For P-FSN25 and P-FSQ30.</b></p> <p>----- PCZ-AHRD0657</p>	 <p><b>Telescopic kit. For plenum for outdoor air kit with damper. For P-FSN25 and P-FSQ30.</b></p> <p>----- PCZ-AHRD0662</p>	 <p><b>Grille for telescopic kit. For plenum for outdoor air kit with damper. For P-FSN25 and P-FSQ30.</b></p> <p>----- PCZ-AHRD0667</p>
<p><b>90° plenum for outdoor air kit with damper. For P-FSN35 and P-FSQ45.</b></p> <p>----- PCZ-AHRD0658</p>	<p><b>Telescopic kit. For plenum for outdoor air kit with damper. For P-FSN35 and P-FSQ45.</b></p> <p>----- PCZ-AHRD0663</p>	<p><b>Grille for telescopic kit. For plenum for outdoor air kit with damper. For P-FSN35 and P-FSQ45.</b></p> <p>----- PCZ-AHRD0668</p>
<p><b>90° plenum for outdoor air kit with damper. For P-FSN45 and P-FSQ60.</b></p> <p>----- PCZ-AHRD0659</p>	<p><b>Telescopic kit. For plenum for outdoor air kit with damper. For P-FSN45 and P-FSQ60.</b></p> <p>----- PCZ-AHRD0664</p>	<p><b>Grille for telescopic kit. For plenum for outdoor air kit with damper. For P-FSN45 and P-FSQ60.</b></p> <p>----- PCZ-AHRD0669</p>
<p><b>90° plenum for outdoor air kit with damper. For P-FSN55 and P-FSQ75.</b></p> <p>----- PCZ-AHRD0660</p>	<p><b>Telescopic kit. For plenum for outdoor air kit with damper. For P-FSN55 and P-FSQ75.</b></p> <p>----- PCZ-AHRD0665</p>	<p><b>Grille for telescopic kit. For plenum for outdoor air kit with damper. For P-FSN55 and P-FSQ75.</b></p> <p>----- PCZ-AHRD0670</p>

**Non-return damper**



**Non-return damper for P-FTQ and P-FSQ.**

-----  
PCZ-AHRD0519

## Rooftops

Rooftop units provide air-based cooling and heating for commercial buildings to ensure thermal comfort and proper indoor air quality (IAQ) through ventilation. Easy installation, space savings and customisation allow you to meet all your needs.





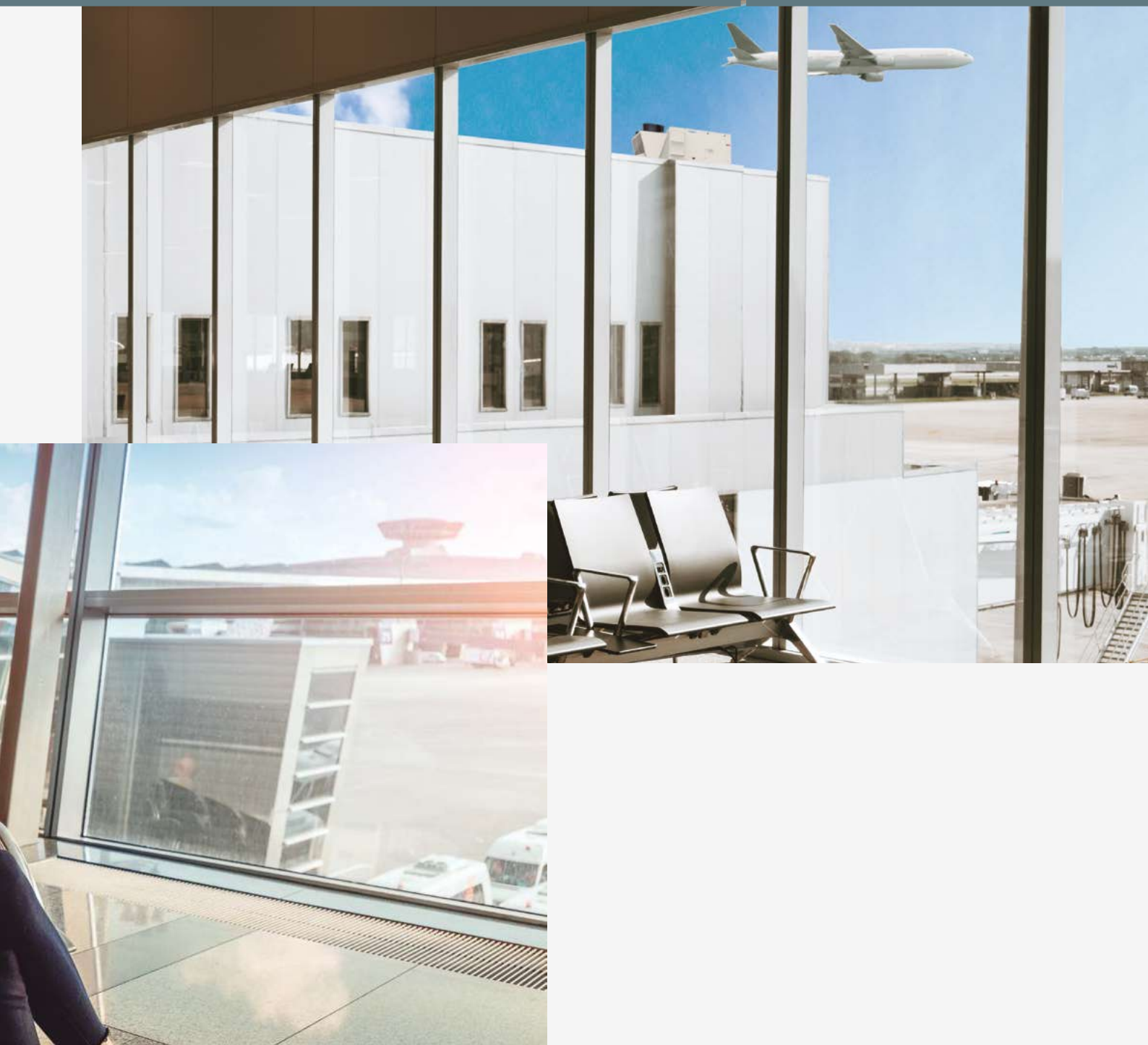

<b>Rooftops</b>	→ 594
Quick selection guide - Rooftops cooling only	→ 596
Quick selection guide - Rooftops reversible	→ 596
Energy recovery system configurations	→ 597
ECOi-RT-Z 40-50 C/H · R32	→ 598
ECOi-RT-Z 105-140 H · R32	→ 600
ECOi-RT C/H · R410A	→ 602

## Rooftops

A complete mono-bloc solution for large buildings.

With rooftop units, you get a complete compact and mono-bloc solution to heat and cool large buildings such as shopping centers, industries or airports that need high capacities. It is an easy to install, space saving solution, directly on the roof or close to a building.



### R32 Rooftop units.

#### Extension of the rooftop range with R32 refrigerant.

2 sizes (40-50).

1 chassis.

- Low energy consumption EC indoor fans
- EC outdoor fan (option)
- Cooling only and heat pump versions
- Wide operating limits: from -15 °C to +50 °C OAT
- Very compact unit
- Double skin (standard)
- Many aeraulic configurations
- Dehumidification
- Fresh air preheating
- Air quality management (option)

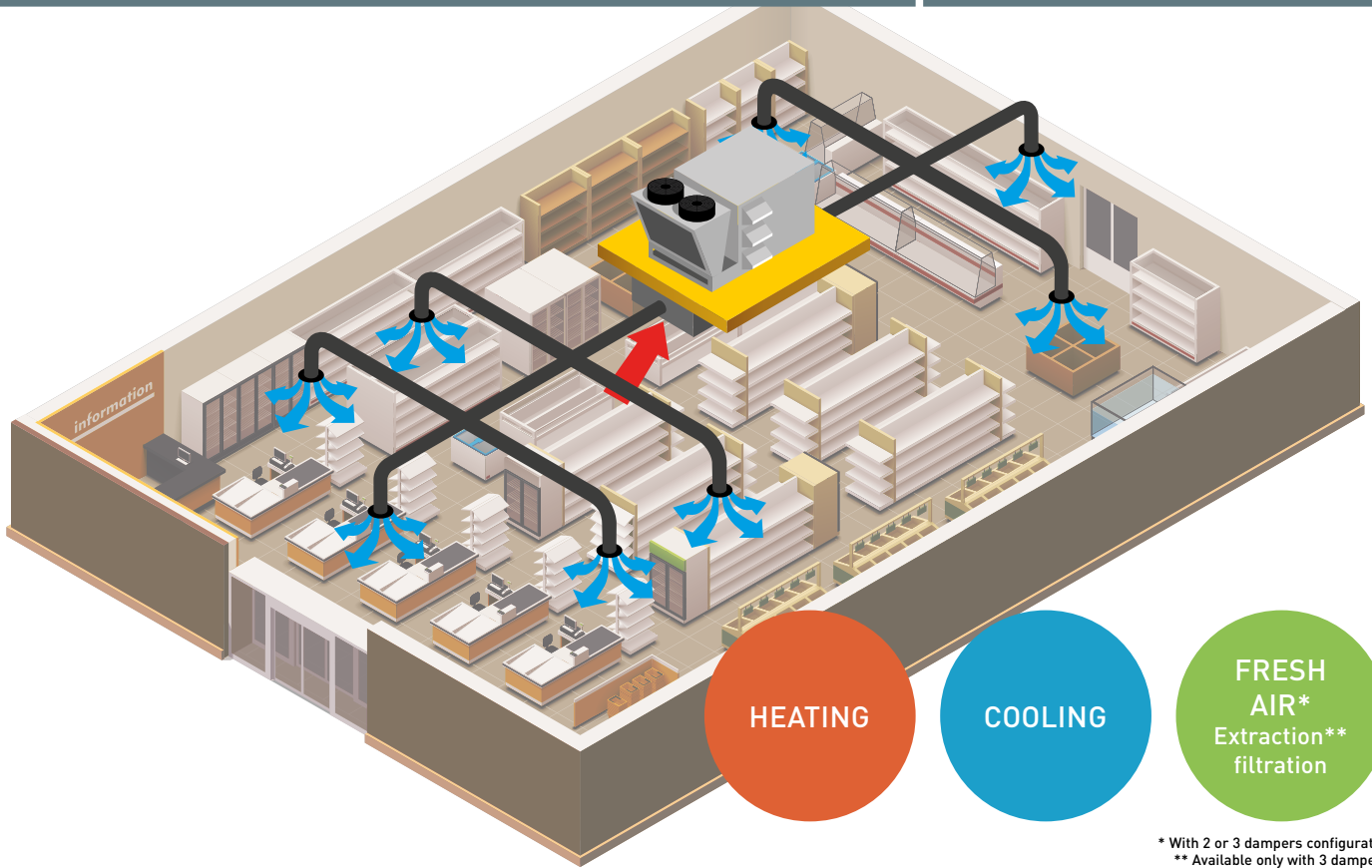

\* With 2 or 3 dampers configurations.  
 \*\* Available only with 3 dampers configuration.



Self-contained solution, compact and mono-bloc.



Capacity range from 40 to 220 kW.

R410A  
R32

Refrigerants: R410A / R32.

HIGH SEER HIGH SCOP

High SEER and SCOP.

HIGH ESP

Very high external static pressure.

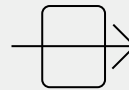

Extractible drain pan.



Many configurations and options.

Ecodesign

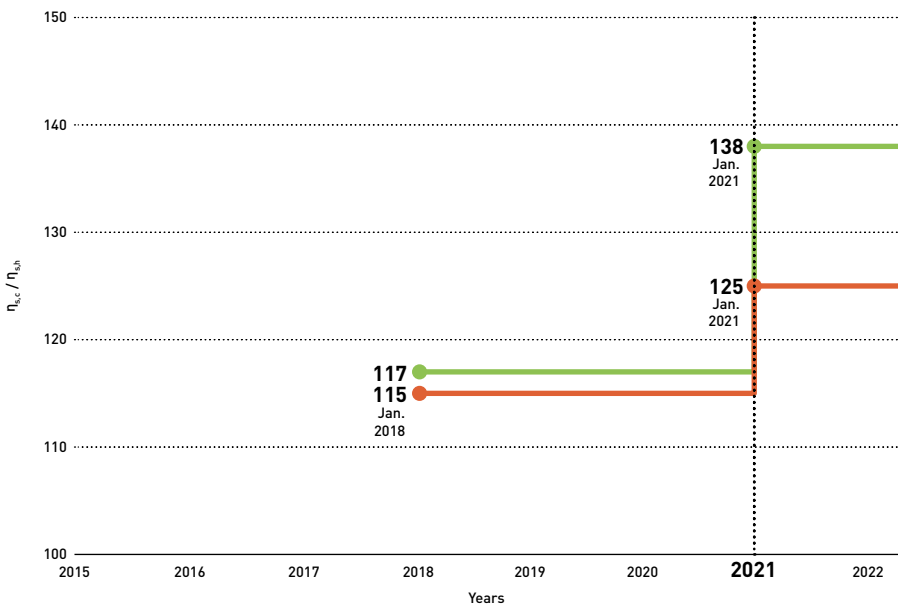

Air to air rooftops cooling only.

Minimum  $\eta_{ec}$  to be Ecodesign compliant. COMMISSION REGULATION (EU) 2016/2281.

Air to air rooftops reversible.

Minimum  $\eta_{sh}$  to be Ecodesign compliant. COMMISSION REGULATION (EU) No813/2013.

## Quick selection guide - Rooftops cooling only

Page	Size	Cooling capacity (kW)	Nominal air flow (m <sup>3</sup> /h)	Sound power (lwo - dB(A))	Dimension L x H x W (mm)
NEW ECOi-RT-Z 40-50 C · R32 P. 598	40	40,80	7500	—	2484 x 1652 x 1850
	50	50,50	9200	—	2484 x 1652 x 1850
ECOi-RT C · R410A P. 602	55	49,60	9720	80	3250 x 1800 x 2030
	65	62,80	11500	83	3250 x 1800 x 2030
	80	79,00	14300	80	3250 x 1800 x 2030
	95	89,27	17500	85	3740 x 2110 x 2285
	105	111,08	19200	85	3740 x 2110 x 2285
	120	119,87	21500	87	3740 x 2110 x 2285
	140	142,09	25500	91	3740 x 2110 x 2285
	160	164,98	28000	91	5505 x 2110 x 2285
	190	197,06	30000	92	5505 x 2110 x 2285
	210	219,12	32000	94	5505 x 2110 x 2285

## Quick selection guide - Rooftops reversible

Page	Size	Cooling and heating capacity (kW)	Nominal air flow (m <sup>3</sup> /h)	Sound power (lwo - dB(A))	Dimension L x H x W (mm)
NEW ECOi-RT-Z 40-50 H · R32 P. 598	40	40,80 52,00	7500	—	2484 x 1652 x 1850
	50	50,50 53,00	9200	—	2484 x 1652 x 1850
ECOi-RT-Z 105-140 H · R32 P. 600	105	106,0 106,0	19200	79,8	3740 x 2150 x 2285
	120	119,0 117,0	21500	79,8	3740 x 2150 x 2285
	140	139,0 142,0	25500	86,1	3740 x 2150 x 2285
ECOi-RT H · R410A P. 602	55	48,1 50,7	9720	80	3250 x 1800 x 2030
	65	61,0 59,7	11500	83	3250 x 1800 x 2030
	80	76,7 76,6	14300	80	3250 x 1800 x 2030
	95	87,2 90,7	17500	85	3740 x 2110 x 2285
	105	107,8 107,0	19200	85	3740 x 2110 x 2285
	120	116,3 117,1	21500	87	3740 x 2110 x 2285
	140	137,9 148,7	25500	91	3740 x 2110 x 2285
	160	160,1 157,9	28000	91	5505 x 2110 x 2285
190	191,2 187,3	30000	92	5505 x 2110 x 2285	
210	212,6 214,4	32000	94	5505 x 2110 x 2285	

\* Heat pump version with EC fans.

# Energy recovery system configurations

## RECO - standard energy recovery (3 dampers)

Energy recovery on the exhaust air.

	Pc	EER	Ph	COP
<b>3 dampers + RECO 30% fresh air</b>	+1%	+2%	+7%	+4%
<b>3 dampers + RECO 60% fresh air</b>	+2%	+4%	+14%	+8%

\* Nominal conditions. Pc: cooling capacity / Ph: heating capacity.

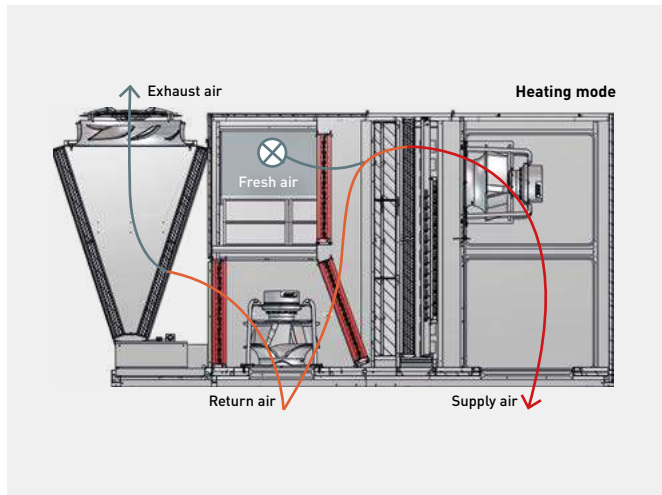

## TRECO - thermodynamic energy recovery (3 dampers)

Active energy recovery between the exhaust air and the fresh air using dedicated thermodynamic system.

	Pc	EER	Ph	COP
<b>3 dampers + TRECO 20% fresh air</b>	+21%	0%	+20%	+3%
<b>3 dampers + TRECO 60% fresh air</b>	+20%	-2%	+21%	+4%

\* Nominal conditions. Pc: cooling capacity / Ph: heating capacity.  
\*\* TRECO is not available for the R32 rooftops.

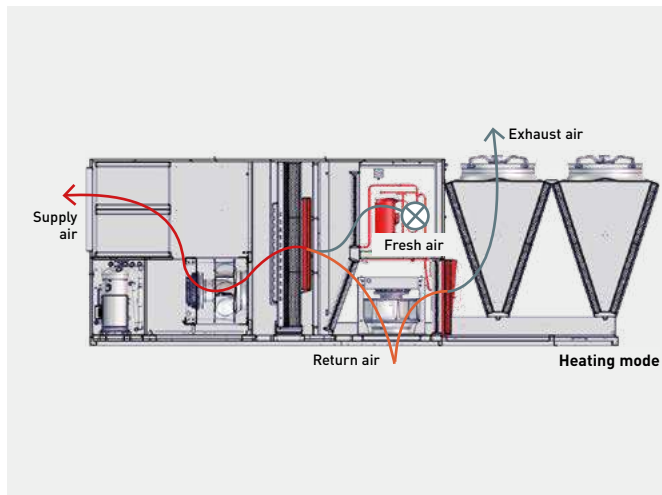

## Supply and return air configurations

<b>Supply air</b>	S1 bottom side supply air
	S2 left side supply air
	S3 front side supply air
	S4 top side supply air
<b>Return air</b>	R1 bottom side return air
	R2 left side return air
	R4 top side return air <sup>1)</sup>

1) Not available with the 3 dampers - RECO system configuration.

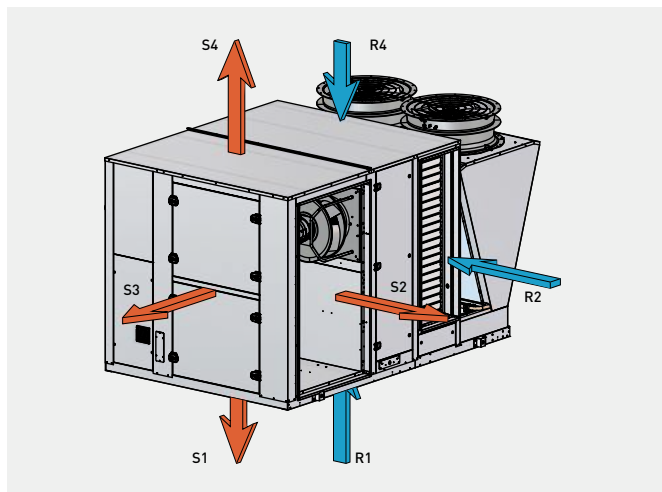

## AC SELECT.

Smart and user-friendly the new air conditioning selection program: <https://acselect.panasonic.eu/>





# ECOi-RT-Z 40-50 C/H · R32

Rooftop cooling only and reversible units.

**Cooling capacity: 40,8 to 50,5 kW.**  
**Heating capacity: 52,0 to 53,0 kW.**

CO<sub>2</sub> carbon footprint  
 reduced by **-80%\***

\* Impact considering only the refrigerants  
 and not the units as a whole.

R32  
 REFRIGERANT

Coming soon. **Summer 2025**



## Operating limits

To be confirmed with AC SELECT:  
<https://acselect.panasonic.eu/>

### Ambient temperature (DB).

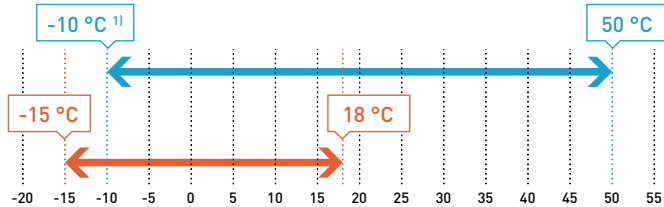

### Temperature before indoor coil <sup>2)</sup>.

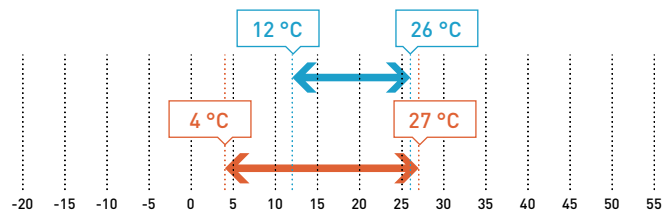

1) Using fan speed control option. 2) Cooling: °C (WB). Heating: °C (DB).

### Accessories and options

2 dampers - for external air inlet
3 dampers - return EC exhaust fan included
Adjustable roof curb
Anti-vibration mounts
Clogged filter sensor (1 or 2 stages)
Compressor soft starter
Container transportation compatibility
Dehumidification function
Electrical heater 18, 27 or 36 kW
Preheater 27 or 36 kW

### Accessories and options

Energy meter
Fan speed control
G4, G4+F7 or G4+F9 filters
Hot water coil
Local and additional remote keyboard
Many aerauc configurations
Room temperature sensor
Sensors (enthalpy, CO <sub>2</sub> )
Smoke detector
Supply EC LPF plug fans

## The range at a glance

- 2 versions: C (cooling only) and H (reversible)
- 2 sizes
- SEER up to 4,35 and SCOP up to 3,56
- Nominal air flow from 19200 to 25500 m<sup>3</sup>/h
- Additional heaters & preheater available
- 3 dampers configuration including EC exhaust fan

## Advantages

- Low GWP R32 refrigerant (GWP= 675)
- Very low sound levels
- Very compact unit
- Safety ventilation system
- Low energy consumption EC indoor fans standard
- Low energy consumption EC outdoor fans in option
- Many supply and return air configurations
- Thermal/acoustic insulation: double skin (25 mm glasswool)
- Dehumidification function (option)
- 100% factory tested

## Equipment

- 1 refrigerant circuit with tandem of compressors. The circuit comprises 2 Scroll compressors in tandem, indoor and outdoor coils, 4 way reversing valve, filter dryer, sight glass, electronic expansion valve, high and low pressure switches, defrosting pressure switch, and temperature sensors
- 2 Scroll compressors in tandem. Each compressor is equipped with a crankcase heater and mounted on rubber pads to eliminate noise and vibration transmissions. The motors are equipped with an overload protection and have direct start-up. A phase sequence monitor is supplied as standard
- The new advanced control system includes, among others, Modbus RTU, Modbus TCP/IP, BACnet IP or BACnet MSTP protocols, optimised defrost logic, very high security envelope, Modbus control of the indoor fans, and a dehumidification function. The controls are grouped and wired in the unit, factory tested and shipped READY TO USE. They are located in a sealed compartment isolated from the air flow. The electrical equipment is compliant with EC standards and EN60204-1
- The outdoor and indoor heat exchangers are made of seamless copper tubes mechanically expanded into aluminium fins. They have a highly optimised design providing a refrigerant charge reduction of 40% (compared to a unit operating with R410A). Outdoor coil is largely dimensioned to optimise performance and defrost cycles. It can also be equipped with a protective grille in option to prevent shocks - Bluefin treatment
- The unit casing is of heavy duty galvanized steel, painted with a special anti-corrosion process (RAL 9001). The complete unit is covered with double skin panels to ensure perfect thermal insulation. For full unit access, all service panels are removable. Under the indoor heat exchanger, an extractable condensate drain pan allows hygienic cleaning
- The indoor fans are plug fan type with EC motors
- A safety ventilation system ensures venting of the refrigerant gas to atmosphere in case of leak



## Technical features

Size				
<b>ECOi-RT-Z 40-50 H - cooling only</b>			<b>40</b>	<b>50</b>
Cooling capacity <sup>1)</sup>	kW		40,8	50,5
Input power <sup>1)</sup>	kW		11,7	15,6
EER <sup>1)</sup>			3,49	3,24
<b>Pdesign <sup>2) 3)</sup></b>	<b>kW</b>		<b>40,8</b>	<b>50,5</b>
<b>SEER <sup>2) 3)</sup></b>			<b>4,28</b>	<b>4,24</b>
<b>Energy efficiency class <sup>2) 3)</sup></b>	<b>A+ to E</b>		<b>B</b>	<b>B</b>
<b><math>\eta_{s,c}</math> <sup>2) 3)</sup></b>			<b>168,3</b>	<b>166,7</b>
ECOi-RT-Z 40-50 H - reversible				
Cooling capacity <sup>1)</sup>	kW		40,8	50,5
Input power <sup>1)</sup>	kW		11,7	15,6
EER <sup>1)</sup>			3,49	3,24
<b>Pdesign <sup>2) 3)</sup></b>	<b>kW</b>		<b>40,8</b>	<b>50,5</b>
<b>SEER <sup>2) 3)</sup></b>			<b>4,28</b>	<b>4,24</b>
<b>Energy efficiency class <sup>2) 3)</sup></b>	<b>A+ to E</b>		<b>B</b>	<b>B</b>
<b><math>\eta_{s,c}</math> <sup>2) 3)</sup></b>			<b>168,3</b>	<b>166,7</b>
Heating capacity <sup>1)</sup>	kW		52,0	53,0
Input power <sup>1)</sup>	kW		11,3	14,7
COP <sup>1)</sup>			3,72	3,61
<b>Pdesign <sup>2) 3)</sup></b>	<b>kW</b>		<b>52,0</b>	<b>53,0</b>
<b>SCOP <sup>2) 3)</sup></b>			<b>3,44</b>	<b>3,42</b>
<b>Energy efficiency class <sup>2) 3)</sup></b>	<b>A+ to E</b>		<b>B</b>	<b>B</b>
<b><math>\eta_{s,h}</math> <sup>2) 3)</sup></b>			<b>134,4</b>	<b>133,6</b>
Electrical data				
Power supply	Voltage	V	400	400
	Phase		Three phase	Three phase
	Frequency	Hz	50	50
Refrigerant and compressors				
Number of refrigerant circuits			1	1
Compressors	Number / type		2 / Scroll	2 / Scroll
Mounting type			Tandem	Tandem
Capacity steps	%		0 / 50 / 100	0 / 50 / 100
Indoor coil				
Coil type			Copper tubes and aluminium fins	Copper tubes and aluminium fins
Outdoor coil				
Coil type			Copper tubes and aluminium fins	Copper tubes and aluminium fins
Indoor fans - EC type				
Fan type			Backward curved centrifugal	Backward curved centrifugal
Number of fans			2	2
Air flow rate	Min. / Nominal / Max.	m <sup>3</sup> /h	7500	9200
Outdoor fans				
Fan	Number / type		2 / Axial	2 / Axial
Dimension and weight				
Dimension	L x W x H	mm	2484 x 1850 x 1652	2484 x 1850 x 1652
Weight (without option)		kg	694	712

1) Following EN 14511 2018. 2) Following EN 14825 2017. 3) Following COMMISSION REGULATION (EU) 2016/2281.





# ECOi-RT-Z 105-140 H · R32

Rooftop reversible units.

**Cooling capacity: 106 to 139 kW.**

**Heating capacity: 106 to 142 kW.**

CO<sub>2</sub> carbon footprint  
reduced by **-80%\***

\* Impact considering only the refrigerants  
and not the units as a whole.

R32  
REFRIGERANT



## The range at a glance

- Reversible version
- SEER up to 3,8 and SCOP up to 3,56
- 3 sizes
- Nominal air flow from 19200 to 25500 m<sup>3</sup>/h
- Additional heaters available
- Many supply and return air configurations
- 1 energy recovery system configuration (RECO)

## Advantages

- Low GWP R32 refrigerant (GWP= 675)
- Very low sound levels
- Safety ventilation system
- Low energy consumption EC fans
- Many supply and return air configurations
- Thermal/acoustic insulation: double skin (25 mm glasswool)
- Dehumidification function (option)
- 100% factory tested

## Operating limits

To be confirmed with AC SELECT:  
<https://acselect.panasonic.eu/>

### Ambient temperature (DB).

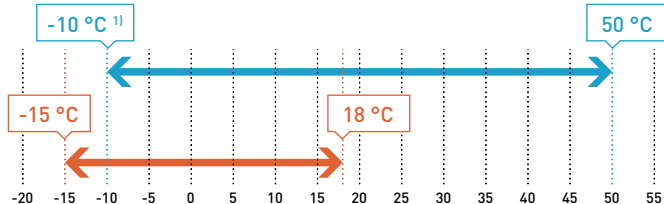

### Temperature before indoor coil <sup>2)</sup>.

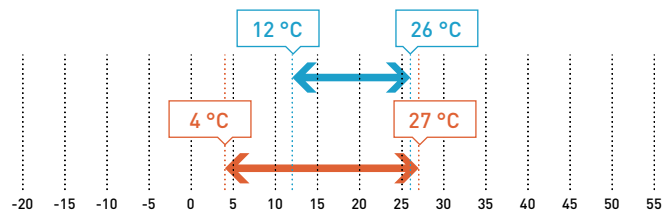

1) Using fan speed control option. 2) Cooling: °C (WB). Heating: °C (DB).

## Equipment

- 2 refrigerant circuits for an optimised defrost logic, completely closed in a separate compartment to reduce noise level. Each circuit comprises of 1 Scroll compressor, indoor and outdoor coils, 4 way reversing valve, filter dryer, sight glass, thermostatic expansion valve, high and low pressure switches, defrosting pressure switch, and temperature sensors
- 2 Scroll compressors - 1 per circuit - covered with sound jackets. Each compressor is equipped with a crankcase heater and mounted on rubber pads to eliminate noise and vibration transmissions. The motors are equipped with an overload protection and have direct start-up. A phase sequence monitor is supplied as standard
- The new advanced control system includes, among others, Modbus protocols, optimised defrost logic, very high security envelope, Modbus control of the indoor fans, and a dehumidification function. The controls are grouped and wired in the unit, factory tested and shipped READY TO USE. They are located in a sealed compartment isolated from the air flow. The electrical equipment is compliant with EC standards and EN60204-1
- The outdoor and indoor heat exchangers are made of seamless copper tubes mechanically expanded into aluminium fins. They have a highly optimised design providing a refrigerant charge reduction of 40% (compared to a unit operating with R410A). Outdoor coils are largely dimensioned to optimise performance and defrost cycles. They are also equipped with a protective grille to prevent shocks - Bluefin treatment
- The unit casing is of heavy duty galvanized steel, painted with a special anti-corrosion process (RAL 9001). The complete unit is covered with double skin panels to ensure perfect thermal insulation. For full unit access, all service panels are removable. Under the indoor heat exchanger, an extractable condensate drain pan allows hygienic cleaning
- The indoor fans are plug fan type with EC motors
- A safety ventilation system ensures venting of the refrigerant gas to atmosphere in case of leak

## ECOi-RT-Z 105-140 H · R32 units are available in 3 configurations:

- No damper: unit working with 100% recycled air
- 2 dampers: with outdoor air inlet
- 3 dampers - RECO system: energy recovery system on the exhaust air. This configuration is equipped with 2 return EC plug fans





## Technical features

Size		105	120	140
<b>ECOi-RT-Z 105-140 H - reversible</b>		<b>P-RTZ0105HA</b>	<b>P-RTZ0120HA</b>	<b>P-RTZ0140HA</b>
Cooling capacity <sup>1)</sup>	kW	106	119	139
Input power <sup>1)</sup>	kW	31,5	36,8	43,0
EER <sup>1)</sup>		3,37	3,23	3,24
<b>Pdesign <sup>2) 3)</sup></b>	<b>kW</b>	<b>106</b>	<b>119</b>	<b>139</b>
<b>SEER <sup>2) 3)</sup></b>		<b>3,82</b>	<b>3,82</b>	<b>3,67</b>
<b>Energy efficiency class <sup>2) 3)</sup></b>	<b>A+ to E</b>	<b>B</b>	<b>B</b>	<b>B</b>
$\eta_{s,c}$ <sup>2) 3)</sup>		<b>150</b>	<b>150</b>	<b>144</b>
Heating capacity <sup>1)</sup>	kW	106	117	142
Input power <sup>1)</sup>	kW	27,0	30,3	38,0
COP <sup>1)</sup>		3,72	3,89	3,69
<b>Pdesign <sup>2) 3)</sup></b>	<b>kW</b>	<b>100</b>	<b>118</b>	<b>140</b>
<b>SCOP <sup>2) 3)</sup></b>		<b>3,36</b>	<b>3,56</b>	<b>3,32</b>
<b>Energy efficiency class <sup>2) 3)</sup></b>	<b>A+ to E</b>	<b>B</b>	<b>B</b>	<b>B</b>
$\eta_{s,h}$ <sup>2) 3)</sup>		<b>131</b>	<b>130</b>	<b>130</b>
<b>Electrical data</b>				
Power supply	Voltage	V	400	400
	Phase		Three phase	Three phase
	Frequency	Hz	50	50
Maximum operating intensity	A	79,0	85,0	105,0
<b>Refrigerant and compressors</b>				
Number of refrigerant circuits		2	2	2
Compressors	Number / type	2 / Scroll	2 / Scroll	2 / Scroll
Mounting type		Single	Single	Single
Capacity steps	%	0 / 50 / 100	0 / 50 / 100	0 / 50 / 100
<b>Indoor coil</b>				
Coil type		Copper tubes and aluminium fins	Copper tubes and aluminium fins	Copper tubes and aluminium fins
Number of rows		4	4	4
Front surface		m <sup>2</sup>	3,24	3,24
<b>Outdoor coil</b>				
Coil type		Copper tubes and aluminium fins	Copper tubes and aluminium fins	Copper tubes and aluminium fins
Number of rows		3	3	3
Front surface		m <sup>2</sup>	1,50	1,50
<b>Indoor fans - EC type</b>				
Fan type		Backward curved centrifugal	Backward curved centrifugal	Backward curved centrifugal
Number of fans		2	2	2
Air flow rate	Min. / Nominal / Max.	m <sup>3</sup> /h	15360 / 19200 / 23040	17200 / 21500 / 25800
Motor power		kW	4,23	4,60
<b>Outdoor fans</b>				
Fan		Number / type	2 / Axial	2 / Axial
Motor power		kW	1,51	1,51
<b>Sound levels</b>				
Sound power		dB(A)	79,8	79,8
Supply sound power		dB(A)	84,2	84,2
Sound pressure at 10 m		dB(A)	48,8	48,8
<b>Dimension and weight</b>				
Dimension	Length total / floor	mm	3740 / 3295	3740 / 3295
	Width / Height	mm	2285 / 2150	2285 / 2150
Weight (without option)		kg	1685	1805

1) Following EN 14511 2018. 2) Following EN 14825 2017. 3) Following COMMISSION REGULATION (EU) 2016/2281.

### Accessories and options

2 dampers - for external air inlet
3 dampers RECO - return EC plug fans included (HPF or LFP) + Recovery
Anti-vibration mounts
Clogged filter sensor (1 or 2 stages)
Compressor soft starter
Container transportation compatibility
Dehumidification function
Electric heater 48 kW
Energy meter

### Accessories and options

Fan speed control
G4, G4+F7 or G4+F9 filters
Hot water coil
Local and additional remote keyboard
Many aeraucic configurations
Room temperature sensor
Sensors (enthalpy, CO <sub>2</sub> )
Smoke detector
Supply EC LPF plug fans

### Accessories supplied loose

<b>P-575505</b>	Kit adjustable roof curb S1R1 - 0/2 Dampers without gas
-----------------	---





# ECOi-RT C/H - R410A

Rooftop cooling only and reversible units.

**Cooling capacity: 48,1 to 219,1 kW.**

**Heating capacity: 50,7 to 214,4 kW.**



## Operating limits

To be confirmed with AC SELECT:

<https://acselect.panasonic.eu/>

Ambient temperature (DB).

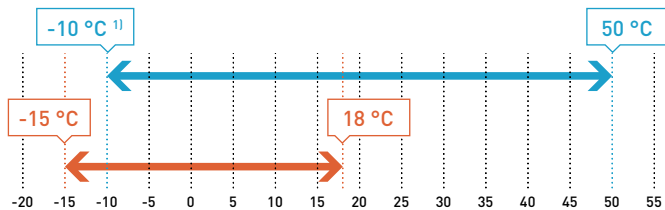

Temperature before indoor coil <sup>2)</sup>.

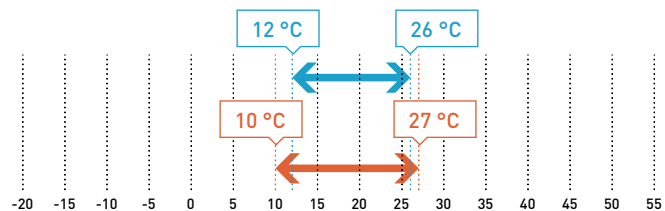

1) Using fan speed control option. 2) Cooling: °C (WB). Heating: °C (DB).

### Accessories and options

AC HP plug fan
Anti-vibration mounts
Clogged filter sensor (1 or 2 stages)
Compatible container transportation
Compressor soft starter
EC or EC HP plug fan
Electric heaters
2-dampers configuration including free-cooling/free-heating functions
Epoxy treatment (indoor/outdoor coils)
Fan speed control
G4, G4+F7 or G4+F9 filters
Gas heater

### Accessories and options

Hot water coil
Local additional remote keyboard
Many aeraulic configurations (bottom, side, front, top)
Modbus / BACnet
RECO or TRECO energy recovery systems including 3-dampers and exhaust fan
FRECO energy recovery system
Room temperature sensor
Sensors (VOC, enthalpy, CO <sub>2</sub> )
Smoke detector

### Accessories supplied loose

<b>P-372062</b>	Kit adjustable roof curb S1R1 - 0/2 dampers with/without gas for sizes 55-80
<b>P-575505</b>	Kit adjustable roof curb S1R1 - 0/2 dampers with/without gas for sizes 95-140
<b>P-575506</b>	Kit adjustable roof curb S1R1 - 0/2 dampers without gas for sizes 160-210
<b>P-374372</b>	Kit adjustable roof curb S1R1 - 0/2 dampers with gas for sizes 160-210
<b>P-372627</b>	Kit adjustable roof curb S1R1 - 3 dampers with/without gas for sizes 55-80
<b>P-372628</b>	Kit adjustable roof curb S1R1 - 3 dampers with/without gas for sizes 95-140
<b>P-372629</b>	Kit adjustable roof curb S1R1 - 3 dampers without gas for sizes 190-210

## The range at a glance

- 2 versions: C (cooling only) and H (reversible)
- SEER up to 3,94 and SCOP up to 3,23
- 10 sizes
- Nominal air flow from 9720 to 32000 m<sup>3</sup>/h
- Additional heaters available
- Many aeraulic configurations
- 2 energy recovery system configurations (RECO and TRECO)

## Advantages

- Very high performances: A class EER and COP
- Low energy consumption EC fans
- Wide operating limits
- Thermal/acoustic insulation: double skin (25 mm glasswool)
- 100% factory tested

## Equipment

- 2 refrigerant circuits for an optimised defrost logic, completely closed in a separate compartment to reduce noise level. Each circuit comprises of Scroll compressor(s) (2 per circuit from size 160), indoor and outdoor coils, 4 way reversing valve (H type), filter dryer, sight glass, thermostatic or electronic expansion valve (from 160 to 210), high and low pressure switches, defrosting pressure switch, intake temperature sensor, and a liquid accumulation bottle (for sizes from 160 to 210)
- 2 or 4 Scroll compressors - 1 per circuit from 55 to 140 and 2 per circuit for 160 to 210 assembled together in tandem. Each compressor is equipped with a crankcase heater and mounted on rubber pads to eliminate noise and vibration transmissions. The motors are equipped with overload protection and have direct start-up. A phase sequence monitor is supplied as standard
- The controls are grouped and wired in the unit, factory tested and shipped READY TO USE. They are located in a sealed compartment that is isolated from the air flow. The electrical equipment is compliant with EC standards and EN60204-1
- The outdoor and indoor heat exchangers are made of seamless copper tubes mechanically expanded into aluminium fins. Outdoor coils are largely dimensioned to optimise performance and defrost cycles. They are also equipped with a protective grille to prevent shocks - Bluefin treatment applicable to reversible type
- The unit casing is of heavy duty galvanized steel, painted with a special anti-corrosion process (RAL 9001). The complete unit is covered with double skin panels to ensure perfect thermal insulation. For full unit access, all service panels are removable. Under the indoor heat exchanger, an extractable condensate drain pan allows hygienic cleaning
- The indoor fan(s) are plug type with AC or EC motors; low pressure or high pressure according to the configuration selected by the customer.



## Technical features

Size		55	65	80	95	105	120	140	160	190	210
<b>ECOi-RT C EC fan - cooling only</b>	<b>P-RTE****CA</b>	<b>0055</b>	<b>0065</b>	<b>0080</b>	<b>0095</b>	<b>0105</b>	<b>0120</b>	<b>0140</b>	<b>0160</b>	<b>0190</b>	<b>0210</b>
Cooling capacity <sup>1)</sup>	kW	49,60	62,80	79,00	89,27	111,08	119,87	142,09	164,98	197,06	219,12
Input power <sup>1)</sup>	kW	15,85	19,44	23,24	28,80	33,56	37,10	47,09	51,19	60,61	71,54
EER <sup>1)</sup>		3,13	3,23	3,40	3,10	3,31	3,23	3,02	3,22	3,25	3,06
<b>Pdesign <sup>2)3)</sup></b>	<b>kW</b>	<b>49,57</b>	<b>62,81</b>	<b>79,00</b>	<b>95,10</b>	<b>111,08</b>	<b>119,87</b>	<b>142,09</b>	<b>164,98</b>	<b>197,06</b>	<b>219,12</b>
<b>SEER <sup>2)3)</sup></b>		<b>3,57</b>	<b>3,58</b>	<b>3,74</b>	<b>3,54</b>	<b>3,66</b>	<b>3,57</b>	<b>3,52</b>	<b>3,91</b>	<b>3,94</b>	<b>3,71</b>
<b>Energy efficiency class <sup>2)3)</sup></b>	<b>A+ to E</b>	<b>B</b>	<b>B</b>	<b>B</b>	<b>B</b>	<b>B</b>	<b>B</b>	<b>B</b>	<b>B</b>	<b>B</b>	<b>B</b>
$\eta_{s,c}$ <sup>2)3)</sup>		<b>140</b>	<b>140</b>	<b>147</b>	<b>139</b>	<b>143</b>	<b>140</b>	<b>138</b>	<b>154</b>	<b>154</b>	<b>145</b>
<b>ECOi-RT H EC fan - reversible</b>	<b>P-RTE****HA</b>	<b>0055</b>	<b>0065</b>	<b>0080</b>	<b>0095</b>	<b>0105</b>	<b>0120</b>	<b>0140</b>	<b>0160</b>	<b>0190</b>	<b>0210</b>
Cooling capacity <sup>1)</sup>	kW	48,10	61,00	76,70	87,21	107,81	116,34	137,88	160,10	191,21	212,60
Input power <sup>1)</sup>	kW	15,82	19,49	23,24	28,97	33,56	37,10	45,69	51,19	60,61	70,47
EER <sup>1)</sup>		3,04	3,13	3,30	3,01	3,21	3,14	3,02	3,13	3,15	3,02
<b>Pdesign <sup>2)3)</sup></b>	<b>kW</b>	<b>48,12</b>	<b>60,95</b>	<b>76,67</b>	<b>92,34</b>	<b>107,81</b>	<b>116,34</b>	<b>137,88</b>	<b>160,10</b>	<b>191,21</b>	<b>212,60</b>
<b>SEER <sup>2)3)</sup></b>		<b>3,53</b>	<b>3,52</b>	<b>3,63</b>	<b>3,52</b>	<b>3,55</b>	<b>3,52</b>	<b>3,52</b>	<b>3,80</b>	<b>3,82</b>	<b>3,65</b>
<b>Energy efficiency class <sup>2)3)</sup></b>	<b>A+ to E</b>	<b>B</b>	<b>C</b>	<b>B</b>	<b>C</b>	<b>B</b>	<b>B</b>	<b>B</b>	<b>B</b>	<b>B</b>	<b>B</b>
$\eta_{s,c}$ <sup>2)3)</sup>		<b>138,12</b>	<b>137,80</b>	<b>142,20</b>	<b>137,80</b>	<b>139,17</b>	<b>138,00</b>	<b>138,00</b>	<b>148,92</b>	<b>149,82</b>	<b>143,15</b>
Heating capacity <sup>1)</sup>	kW	50,65	59,65	76,63	90,66	106,95	117,10	148,70	157,90	187,31	214,37
Input power <sup>1)</sup>	kW	14,81	17,49	21,77	26,59	30,38	34,14	42,85	46,17	54,29	62,68
COP <sup>1)</sup>		3,42	3,41	3,52	3,41	3,52	3,43	3,47	3,42	3,45	3,42
<b>Pdesign <sup>2)3)</sup></b>	<b>kW</b>	<b>48,00</b>	<b>58,00</b>	<b>67,00</b>	<b>85,00</b>	<b>100,00</b>	<b>112,00</b>	<b>145,00</b>	<b>155,00</b>	<b>180,00</b>	<b>210,00</b>
<b>SCOP <sup>2)3)</sup></b>		<b>3,20</b>	<b>3,22</b>	<b>3,22</b>	<b>3,23</b>	<b>3,22</b>	<b>3,21</b>	<b>3,20</b>	<b>3,19</b>	<b>3,23</b>	<b>3,19</b>
$\eta_{s,h}$ <sup>2)3)</sup>		<b>125,00</b>	<b>125,80</b>	<b>125,80</b>	<b>126,20</b>	<b>126,00</b>	<b>125,00</b>	<b>125,00</b>	<b>125,00</b>	<b>126,00</b>	<b>125,00</b>
<b>Electrical data</b>											
Power supply	Voltage	V	400	400	400	400	400	400	400	400	400
	Phase		Three phase	Three phase	Three phase	Three phase	Three phase	Three phase	Three phase	Three phase	Three phase
	Frequency	Hz	50	50	50	50	50	50	50	50	50
Maximum operating intensity	A	46,30	57,60	74,60	83,80	89,80	103,00	123,00	157,80	161,80	178,60
Start intensity (without soft starter)	A	156,10	175,00	184,60	225,80	276,80	290,00	347,00	266,80	303,80	365,60
Start intensity (with soft starter)	A	69,96	85,68	113,60	125,40	139,20	152,40	185,40	198,10	203,40	228,00
<b>Refrigerant and compressors</b>											
Number of refrigerant circuits		2	2	2	2	2	2	2	2	2	2
Compressors	Number / type	2 / Scroll	2 / Scroll	2 / Scroll	2 / Scroll	2 / Scroll	2 / Scroll	2 / Scroll	4 / Scroll	4 / Scroll	4 / Scroll
Mounting type		Single	Single	Single	Single	Single	Single	Single	Tandem	Tandem	Tandem
Capacity steps	%	0 / 50 / 100	0 / 50 / 100	0 / 50 / 100	0 / 50 / 100	0 / 50 / 100	0 / 50 / 100	0 / 50 / 100	0 / 25 / 50 / 75 / 100	0 / 25 / 50 / 75 / 100	0 / 25 / 50 / 75 / 100
Crankcase heater	W	2 x 70	2 x 70	2 x 70	2 x 70	2 x 70	2 x 70	2 x 120	4 x 70	4 x 70	2 x 70 - 2 x 120
<b>Indoor coil</b>											
Coil type		Copper tubes and aluminium fins	Copper tubes and aluminium fins	Copper tubes and aluminium fins	Copper tubes and aluminium fins	Copper tubes and aluminium fins	Copper tubes and aluminium fins	Copper tubes and aluminium fins	Copper tubes and aluminium fins	Copper tubes and aluminium fins	Copper tubes and aluminium fins
Number of rows		3	3	4	3	4	4	4	4	6	6
Front surface	m <sup>2</sup>	1,50	1,80	2,25	2,25	3,24	3,24	3,24	3,24	3,24	3,24
<b>Indoor fan(s) - EC type</b>											
Fan type		Backward curved centrifugal	Backward curved centrifugal	Backward curved centrifugal	Backward curved centrifugal	Backward curved centrifugal	Backward curved centrifugal	Backward curved centrifugal	Backward curved centrifugal	Backward curved centrifugal	Backward curved centrifugal
Number of fans		1	1	2	2	2	2	2	2	2	2
Air flow rate	Minimum	m <sup>3</sup> /h	7760	9200	11440	14000	15600	17200	20400	24000	25400
	Nominal	m <sup>3</sup> /h	9720	11500	14300	17500	19500	21500	25500	28000	30000
	Maximum	m <sup>3</sup> /h	11640	13800	17160	21000	23400	25800	30600	33600	36000
Motor power	kW	3,5	5,7	5,8	7	7	11,4	11,4	13,5	13,5	13,5
<b>Outdoor coil</b>											
Coil type		Copper tubes and aluminium fins	Copper tubes and aluminium fins	Copper tubes and aluminium fins	Copper tubes and aluminium fins	Copper tubes and aluminium fins	Copper tubes and aluminium fins	Copper tubes and aluminium fins	Copper tubes and aluminium fins	Copper tubes and aluminium fins	Copper tubes and aluminium fins
Number of rows		2	2	3	2	3	3	3	2	3	3
Front surface	m <sup>2</sup>	0,76	1,01	1,01	1,50	1,50	1,50	1,50	2,70	2,70	2,70
<b>Outdoor fans</b>											
Fan type		Axial	Axial	Axial	Axial	Axial	Axial	Axial	Axial	Axial	Axial
Number of fans		2	2	2	2	2	2	2	4	4	4
Diameter	mm	630	710	710	800	800	800	800	800	800	800
Air flow rate	Nominal	m <sup>3</sup> /h	9800	13000	13000	20000	20000	20000	20000	15500	15500
Motor power	kW	0,62	0,94	0,94	1,65	1,65	1,65	1,65	0,84	0,84	1,65
<b>Sound levels</b>											
Sound power (lwo) - outside	C type	dB(A)	80	83	80	85	85	87	91	91	92
	H type	dB(A)	80	83	80	81	85	87	91	91	92
Sound power (lwi) - in supply duct	dB(A)	87	94	89	90	91	95	100	91	92	88
<b>Dimension and weight</b>											
Length	Total	mm	3250	3250	3250	3740	3740	3740	3740	5505	5505
	Floor	mm	2895	2895	2895	3295	3295	3295	3295	5050	5050
Width	mm	2030	2030	2030	2285	2285	2285	2285	2285	2285	2285
Height	mm	1800	1800	1800	2110	2110	2110	2110	2110	2110	2110
Weight (without option)	kg	1085	1155	1225	1470	1637	1757	1787	2350	2555	2608

1) Following EN 14511 2018. 2) Following EN 14825 2017. 3) Following COMMISSION REGULATION (EU) 2016/2281.



ErP: ECOi-RT H and ECOi-RT C 105/160/190/210 need to be equipped with EC fans to be ErP compliant. Eurovent certification from size 55 to 95.





## CO<sub>2</sub> condensing units - CR Series with natural refrigerant

Panasonic's CO<sub>2</sub> condensing units - CR Series provide the ideal solution for supermarkets, convenience stores and gas stations. Keeping food always fresh at right temperature in showcases or cold rooms is a very critical point. And one of the biggest challenges for those retailers has been the expensive effects of refrigeration breakdowns which can result in costly product wastage.





### Choose the sustainable green solution by Panasonic

Natural solution with high energy saving	→ 606
A sustainable refrigeration systems in your food retail	→ 608
The safe refrigeration systems for your healthcare business	→ 610
CO <sub>2</sub> transcritical condensing units - CR Series	→ 611
Technology by Panasonic	→ 612
Control and connectivity	→ 614
Range of CO <sub>2</sub> condensing units - CR Series	→ 616
Accessories and control	→ 618
CO <sub>2</sub> condensing units - CR Series	→ 619
	→ 620

### Panasonic PACi NX Elite can cool rooms down to 8 °C

Bringing nature's balance indoors	→ 622
PACi NX Series Elite wall-mounted - PK4 · R32	→ 624
PACi NX Series Elite 4 way 90x90 cassette - PU3 · R32	→ 626
PACi NX Series Elite ceiling - PT3 · R32	→ 627
PACi NX Series Elite adaptive ducted unit - PF3 · R32	→ 628
PACi NX Jet Air Stream · R32	→ 629
Accessories and control - PACi NX	→ 630
	→ 631

# Choose the sustainable green solution by Panasonic

Environmentally friendly CO<sub>2</sub> condensing units - CR Series and medium temperature solutions with PACi NX R32.



CO <sub>2</sub> condensing units - CR Series						Medium temperature solutions with PACi NX
MT/LT Type	MT Type	MT/LT Type	MT Type	MT/LT Type	MT/LT Type	
<b>Capacity range (kW)</b>						<b>Capacity range (kW)</b>
4 (MT) / 2 (LT)	7,5	8 (MT) / 4 (LT)	15	16 (MT) / 8 (LT)	29 (MT) / 15 (LT)	2,10 to 23,77
<b>Low temperature</b>						<b>Low temperature</b>
✓	—	✓	—	✓	✓	—
<b>Medium temperature</b>						<b>Medium temperature</b>
✓	✓	✓	✓	✓	✓	✓
<b>High Temperature</b>						<b>High Temperature</b>
—	—	—	—	—	—	✓
<b>Heat recovery port</b>						<b>Heat recovery port</b>
—	✓	✓	—	✓	✓	—
<b>ET (evaporation temperature) set points range</b>						<b>Room temp. set point</b>
-45 ~ -5 °C	-20 ~ -5 °C	-45 ~ -5 °C	-20 ~ -5 °C	-45 ~ -5 °C	-45 ~ -5 °C	+8 ~ +24 °C WB
<b>Room size example (m<sup>2</sup>)*</b>						<b>Room size example (m<sup>2</sup>)*</b>
40 (MT) / 10 (LT)	80	80 (MT) / 20 (LT)	200	200 (MT) / 50 (LT)	300 (MT) / 75 (LT)	From 6

\* Room size is reference. Please contact to authorized Panasonic dealer for calculation.

## Energy saving



### Natural CO<sub>2</sub> / R744.

R744 refrigerant provides higher energy saving and lower CO<sub>2</sub> emission compared to R404A. Zero ODP and GWP=1 means natural substance.



### Refrigerant R32.

Our heat pumps containing R32 refrigerant show a drastic reduction in the value of Global Warming Potential (GWP). An important step to reduce greenhouse gases. R32 is also a component refrigerant, making it easy to recycle.



### Inverter Plus system.

Inverter Plus system classification highlights Panasonic's highest performing systems.



### High efficiency compressor.

Powerful 2-stage CO<sub>2</sub> rotary compressor by Panasonic. It delivers high performance all year around.

## High performance and indoor air quality



### Super quiet.

Systems operate extremely quiet. Minimum 33 dB(A) @10 m with OCU-CR400VF8(SL).



### Operating range up to 43 °C.

The system operates up to 43 °C, allowing for installation in various locations.



### Anti corrosion coating.

Selectable fin type with or without an anti corrosion coating. The anti corrosion coating prevents salt damage for a longer lifespan.



### Heat recovery port.

The heat recovery port is available to cut running costs as optional. By utilizing exhausted heat generated by refrigeration to the energy source for heating.



### Automatic fan operation.

Microprocessor control automatically adjusts the outdoor fan speed in CO<sub>2</sub> systems for efficient operation.



### 5 Years compressor warranty.

We guarantee the outdoor unit compressors in the entire range for five years.

## High connectivity



### BMS connectivity.

The system can be supervised with major monitoring system.

## Why CO<sub>2</sub>? Natural refrigerant.

EU F-Gas regulation is a key priority for European countries. It ensures compliance with the Kigali Amendment supporting international climate commitments on greenhouse gases and leading the global transition to climate-friendly HFC-free technologies. Carbon dioxide (R744) is regaining its place in the refrigeration world. Driven by environmental concerns, legislation now requires increased adoption of 'alternative' refrigerants, such as CO<sub>2</sub>. CO<sub>2</sub> is an environmentally-friendly solution, with zero ODP and "GWP" (Global Warming Potential)=1 means natural substance in the atmosphere.

In Europe a step-by-step HFC reduction has been in place since the F-Gas regulation was introduced in 2015. Countries all over the world have actively been preparing to enact the necessary domestic legislation to implement the agreement to reduce the use of HFCs. Panasonic is now able to provide a solution in Europe with CO<sub>2</sub> refrigeration systems to prevent global warming and to support environment-friendly retail operations. The following table shows how well R744 (CO<sub>2</sub>) performs regarding environmental impact and safety.

ODP (Ozone Depletion Potential) = 0 - GWP (Global Warming Potential) = 1

	Next generation refrigerant			Current refrigerant	
	CO <sub>2</sub>	Ammonia	Isobutane	R410A	R404A
ODP	0	0	0	0	0
GWP	1	0	4	2090	3920
Flammability	Non flammable	Light flammable	Flammable	Non flammable	Non flammable
Toxicity	No	Yes	No	No	No

## Comparison of CO<sub>2</sub> emissions

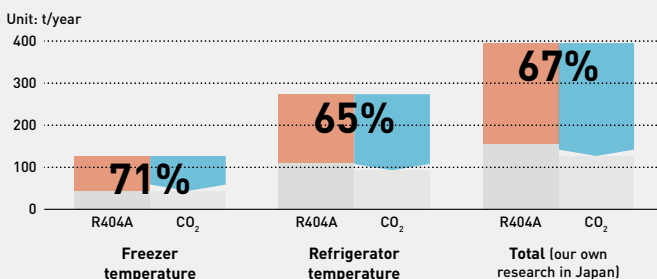

Energy saving  
25,4% freezer  
16,2% refrigeration

CO<sub>2</sub> emission  
67% reduction

Direct influence <sup>1)</sup> Indirect influence <sup>2)</sup>

1) Direct influence presents the effect of refrigerant leakage comparing R744 (CO<sub>2</sub>) with R404A.  
2) Indirect influence presents CO<sub>2</sub> emissions linked to power consumption of CO<sub>2</sub> unit and conventional units.  
By Panasonic research in Japan. Comparing 6 shops average for R404A Inverter multi condensing unit.

## Natural solution with high energy saving

Panasonic's range of CO<sub>2</sub> condensing units - CR Series with natural refrigerant, and R32 complete systems for HT applications offer a reliable solution for a wide range of applications, including convenience stores, supermarket, gas stations and cold rooms.





Showcases.

Convenience stores, supermarkets, gas-stations.

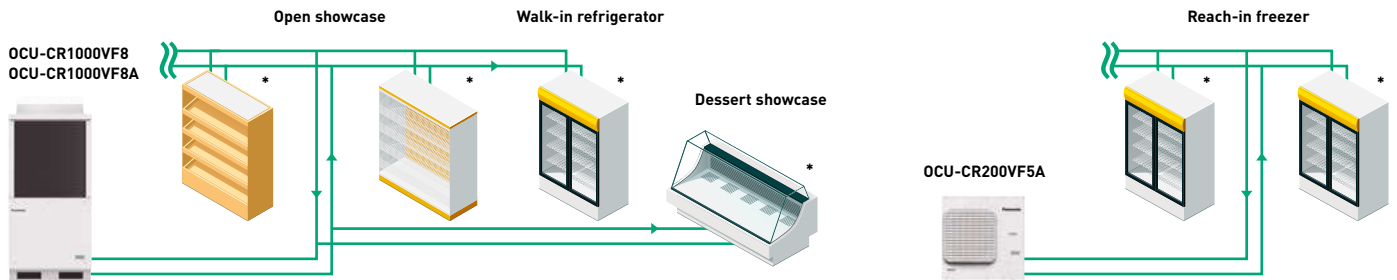

\* Controllers: PAW-CO2-PANEL-C or local supply.

Cold room application to keep food fresh

Multiple installation capabilities. Unparalleled flexibility:

- Food retail applications (convenience store, supermarkets, gas-stations)
- Food service applications (restaurants, canteens, schools)
- Non-food applications (warehousing, industrial storage, healthcare)

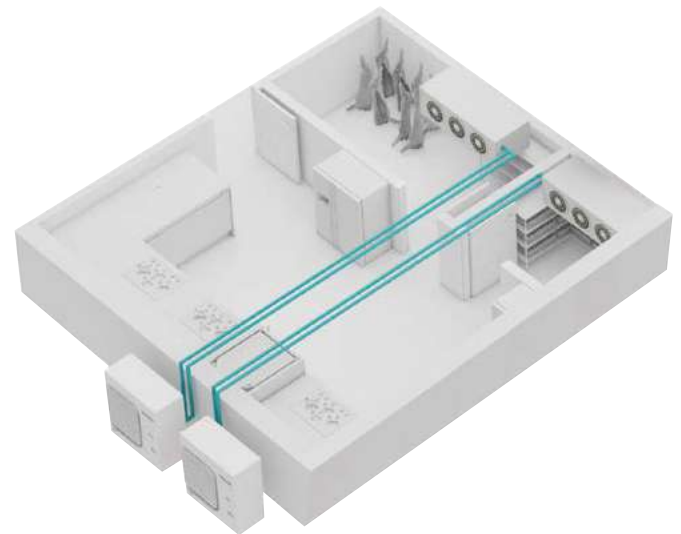
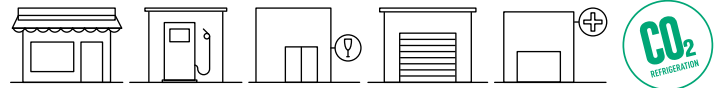

Cold room application integrated with PACi NX Series

Panasonic offers various solutions for cold rooms by combining a wide range of products. Integrated with PACi NX Series, it allows for flexible design and installation.



CO<sub>2</sub> condensing units - CR Series for refrigerated room.



PACi NX Series for cooling rooms between 8 °C WB and 24 °C WB.

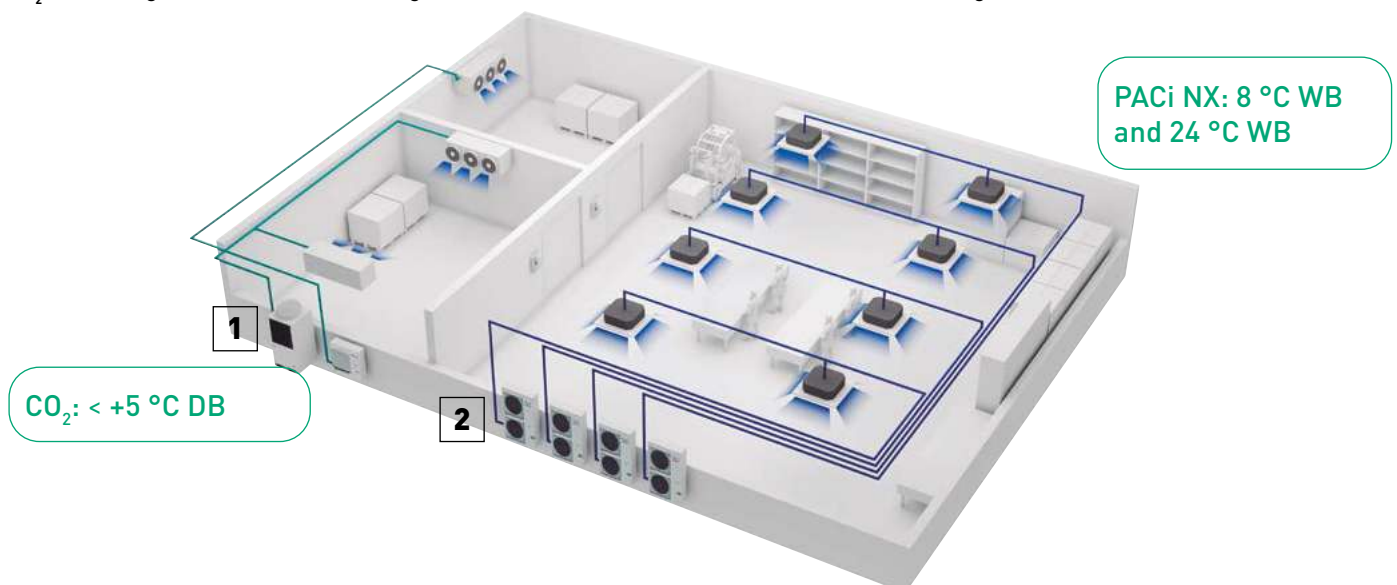

# A sustainable refrigeration systems in your food retail

CO<sub>2</sub> refrigerant is the choice to curb carbon footprint of any business organization, especially to food retailers, to whom it brings key advantages.

Panasonic professional strongly supports your projects to meet customer's request!



**1**  
10 HP MT TYPE  
(OCU-CR1000VF8).

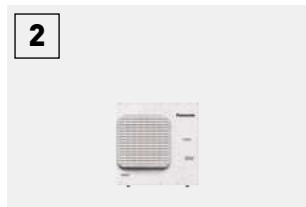

**2**  
2 HP MT/LT TYPE  
(OCU-CR200VF5A).

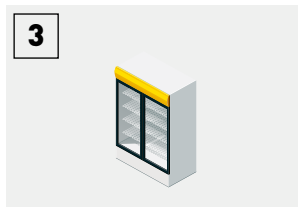

**3**  
Reach-in freezer (field supplied).

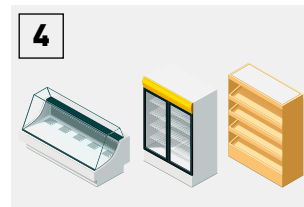

**4**  
Serve-over counters,  
showcase and walk-in  
refrigerator (field supplied).

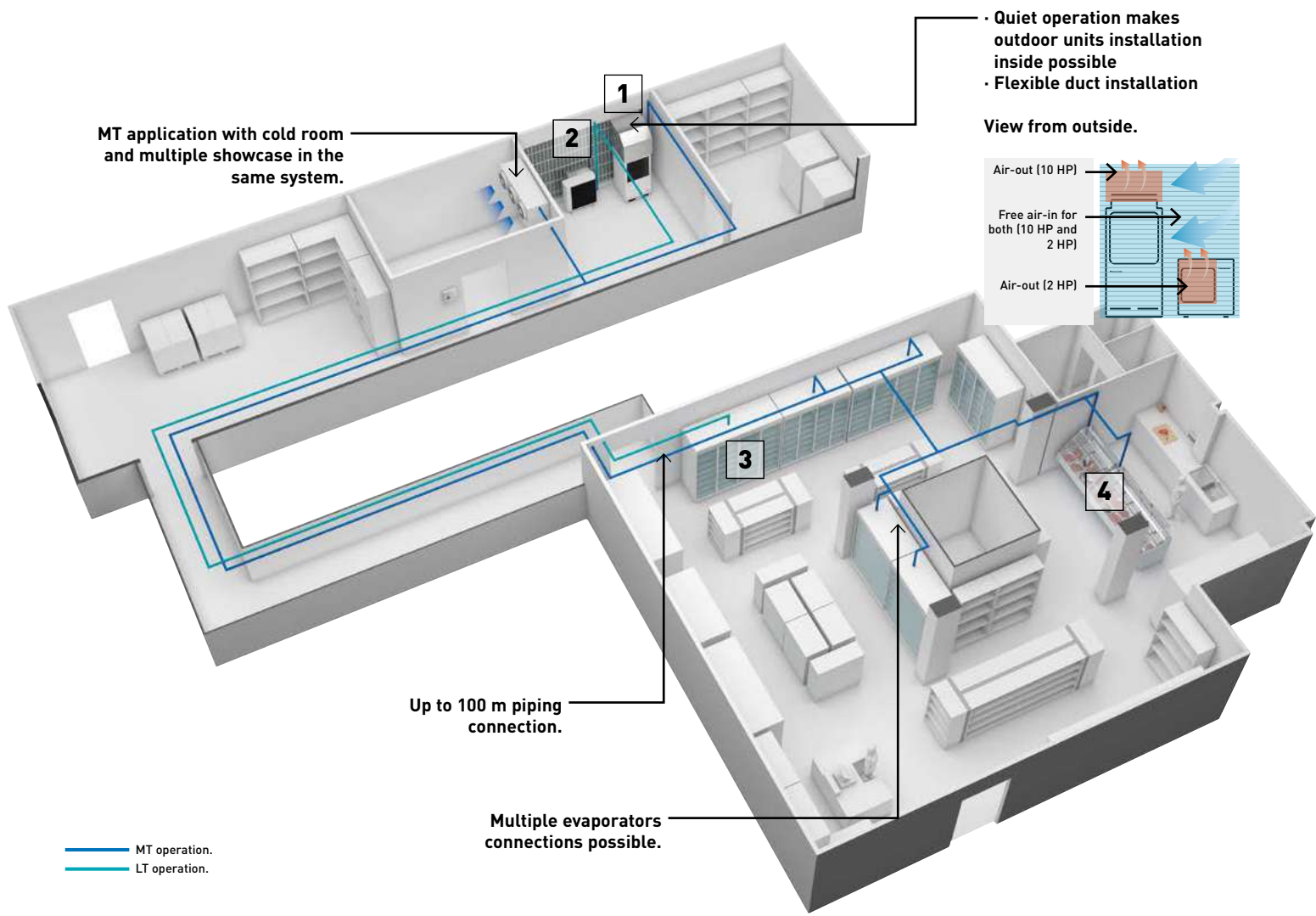

### Nolan's Supermarket.

Nolan's Supermarket celebrated its 60th year in business with an extension and full refurbishment which completely overhauled the existing store.

A particular focus of the project was to create a state-of-the-art refrigeration system operating on the 'Zero Ozone Depletion' plus ultralow GWP of 1 natural refrigerant CO<sub>2</sub> and as part of the scheme. Panasonic CO<sub>2</sub> condensing units - CR Series have been chosen because of the high performance and reliable quality.

# The safe refrigeration systems for your healthcare business

CO<sub>2</sub> is the right refrigerant to curb carbon footprint of any business organization. In addition, there are advantages specially for healthcare business. The project example shows one of the warehouse in the healthcare laboratory which requires several cold rooms there to keep bio-products safely.



**1**  
10 HP LT TYPE  
(OCU-CR1000VF8A).



**2**  
10 HP MT TYPE  
(OCU-CR1000VF8).

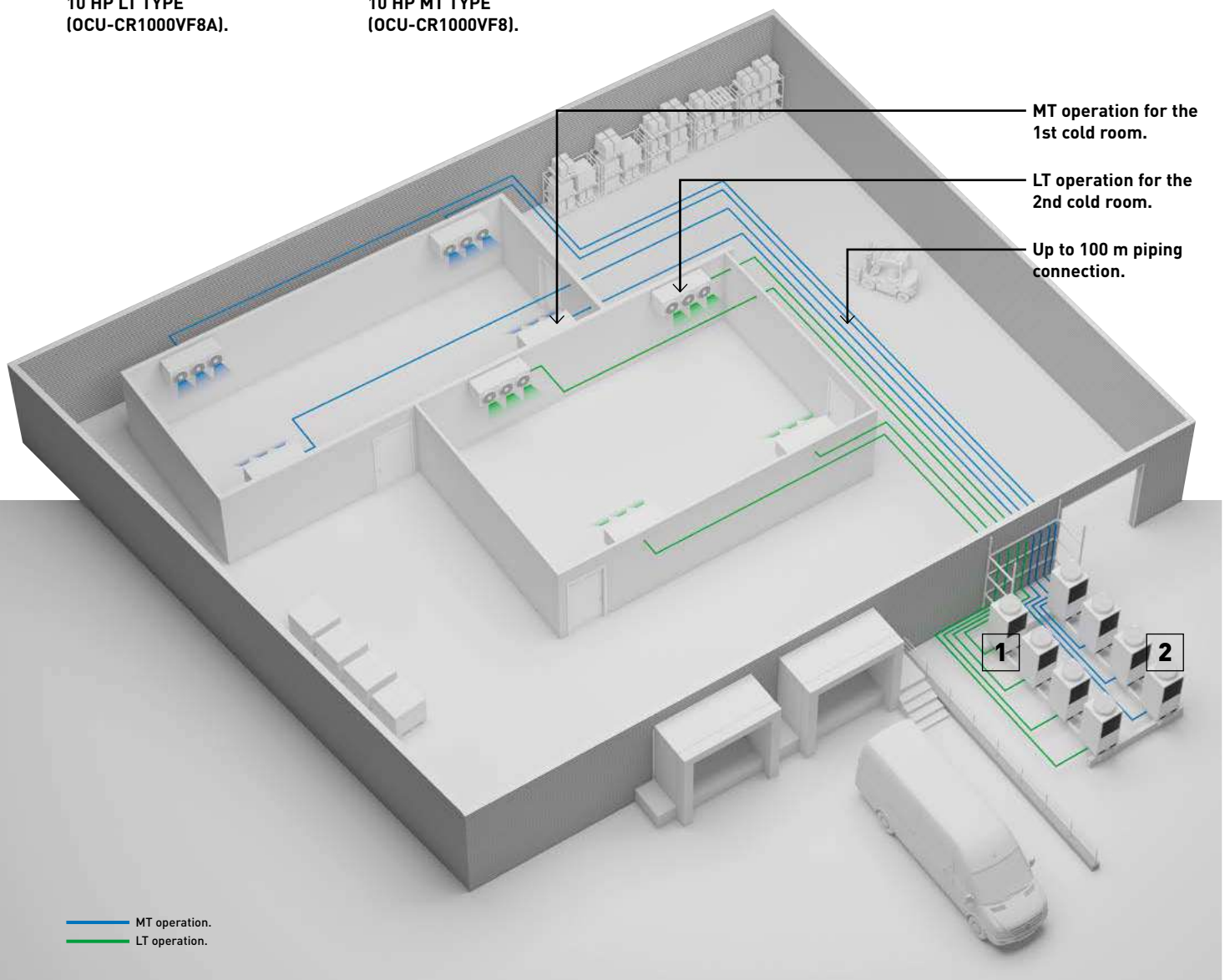

## STEMCELL Technologies.

STEMCELL Technologies is a global biotechnology company that develops, manufactures and sells products and provides services that support academic and industrial scientists. Panasonic CO<sub>2</sub> condensing units - CR Series have been chosen to fulfill the expectation of environmental-friendly and safety requirements. The products with reliable quality and high performance was also an essential point.

## CO<sub>2</sub> transcritical condensing units - CR Series

CR Series offer a wide range of refrigeration systems, meeting the specific needs of small retail stores.



### CR Series 20 HP MT/LT model.

The CR Series now includes 20 HP MT/LT model, a highly efficient multi compressor solution.

- Multi-compressor systems
- Smaller footprint
- Maximum piping length of 100 m
- Cooling capacity can be controlled from 25 to 100% under partial load
- Flexible and precise control capabilities with digital input/output

### Energy efficient multi compressors operation.

By distributing the workload between two compressors, the system operate efficiently, adjusting capacity to match the varying cooling demands. Compressors 1 and 2 alternate every 10 days to ensure even load distribution.

Example of compressor operation.

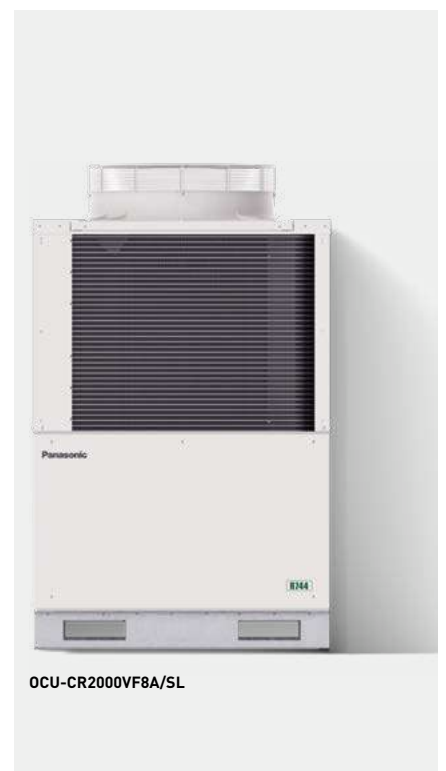
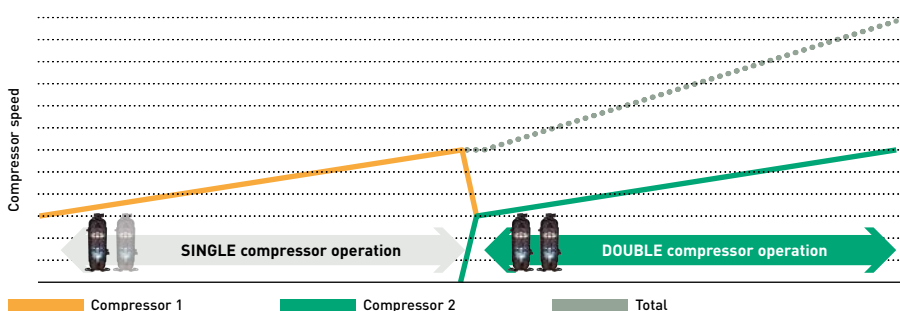

## Superior cooling capacity at each evaporating temperature.

CO<sub>2</sub> transcritical condensing units - CR Series have a high cooling capacity at each set point. The CO<sub>2</sub> 2-stage compressor developed by Panasonic is designed to compress CO<sub>2</sub> refrigerant twice; it reduces the load in operation by half (compared to 1-stage refrigerant compression) and delivers increased durability and reliability.

Units can be programmed to run at low and medium temperatures at initial set-up. These settings can then be modified by turning a simple and user friendly rotary switch to further enhance energy savings.

### MT/LT Type: 200VF5A - 4 / 2 kW.

3,83 SEPR cooling.  
1,92 SEPR freezing.

\* SEPR values has been tested at 3-part laboratory.



OCU-CR200VF5A(SL) <sup>1)</sup>.

Cooling capacity (kW)

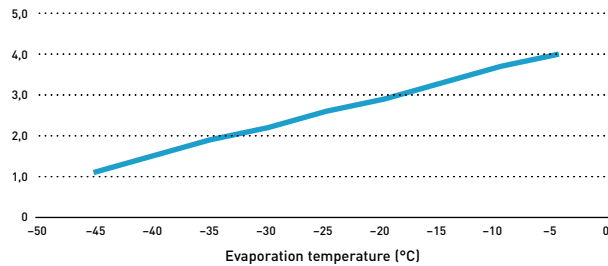

### MT Type: 400VF8 - 7,5 kW. MT/LT Type: 400VF8A - 8 / 4 kW.

2,45 SEPR cooling.  
1,56 SEPR freezing.

\* Model 400VF8A.



OCU-CR400VF8(SL) / OCU-CR400VF8A(SL) <sup>2)</sup>.

Cooling capacity (kW)

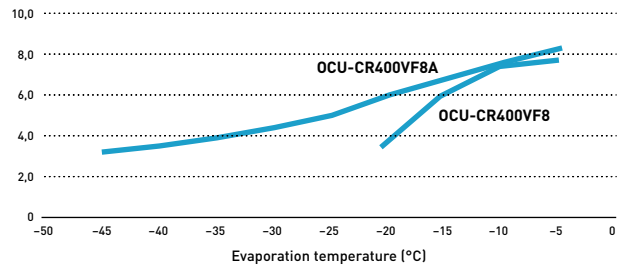

### MT Type: 1000VF8 - 15 kW. MT/LT Type: 1000VF8A - 16 / 8 kW.

2,86 SEPR cooling.  
1,49 SEPR freezing.

\* Model 1000VF8A.



OCU-CR1000VF8(SL) / OCU-CR1000VF8A(SL) <sup>2)</sup>.

Cooling capacity (kW)

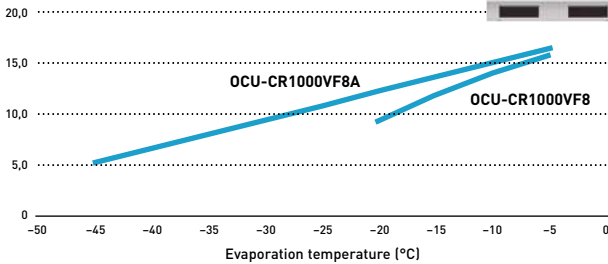

### MT/LT Type: 2000VF8A - 29 / 15 kW.

3,10 SEPR cooling.  
1,64 SEPR freezing.

OCU-CR2000VF8A(SL) <sup>1)</sup>.

Cooling capacity (kW)

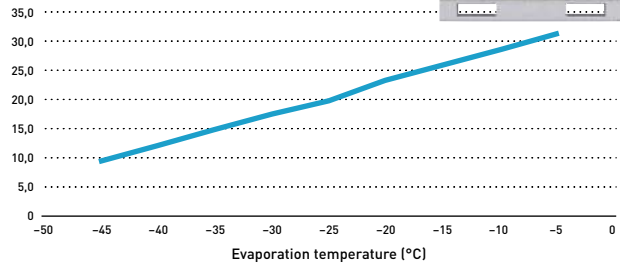

1) Ambient temperature: 32 °C, 230 V, refrigerant: R744, suction gas temperature: 18 °C. 2) Ambient temperature: 32 °C, 400 V, refrigerant: R744, suction gas temperature: 18 °C.

## 1 Superior efficiency with reliable quality

- Panasonic has combined the 2-stage compressor with the split cycle for increased efficiency
- High seasonal performance. SEPR: Maximum 3,83 in cooling, 1,92 in freezing\*
- High COP at high ambient temperature

\* 200VF5A.

## 2 Heat recovery port <sup>1)</sup> as renewable energy

- Maximum 16,7 kW <sup>2)</sup> of heating for free
- Optional possibility to get subsidy (depending on location)
- Easy connection process

1) For models 1000VF8A and 2000VF8A. 2) For model 1000VF8A.

## 3 Flexible installation

- Set-points at medium or low temperature available depending on applications
- Compact unit
- Silent operation
- Long piping length: Maximum 100 m\*
- High external static pressure
- Transfer pressure control for stable electric expansion valve control in showcases\*

\* For models 1000VF8A and 2000VF8A.

## Technology by Panasonic

Excellent quality control established by skilled factory team.

Reliability is our main target and therefore we offer compressor warranties of 5 years, and 2 year warranties on other components!



### Reliable CO<sub>2</sub> technology by Panasonic

- Reliable quality: Made in Japan
- 19500 units sold and installed in more than 5200 retail operations such as convenience stores and supermarkets in Japan\*
- Excellent quality control established by skilled factory team
- Panasonic offers 5 year warranties on compressors and 2 years on components
- The 5 year compressor warranty matches the products long lifespan

\* As of the end of December 23.

## Panasonic's combined technology of the 2-stage compressor with the split cycle.

- Panasonic 2-stage rotary compressor delivering powerful performance for more than 20 years
- Split cycle\* enhances cooling effect

\* Available for 200VF5A, 400VF8A, 1000VF8A and 2000VF8A models.

\*\* In the case that the standard cycle with 1-stage rotary compressor was compared.

Watch the highlighted technology video.

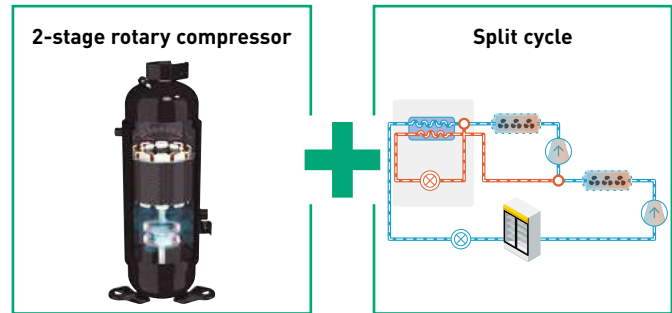

### Standard cycle.

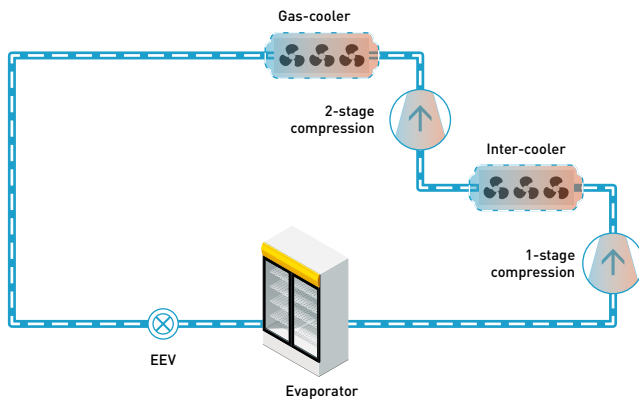

### Split cycle.

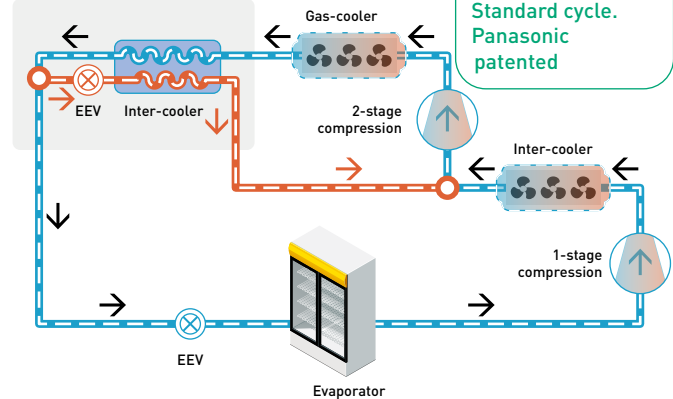

Up to 50%\*\*  
More efficient than  
Standard cycle.  
Panasonic  
patented

## Heat recovery function for heating

This function offers refrigeration combined with heating all in one system. The ground-breaking solution allows for increased opportunity to cut running costs by utilizing exhausted heat from refrigeration and transferring to the energy source for heating.

16,7 kW<sup>1)</sup>  
Of hot water  
for free

### What is heat recovery function?

#### Solution example.

Heat recovery system can produce both heating and refrigeration.

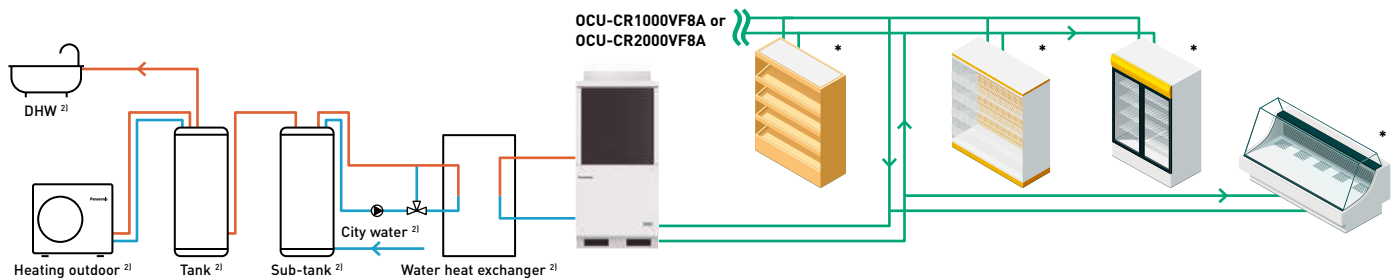

1) Tested with OCU-CR1000VF8A. Under the condition: ambient temperature 32 °C, evaporation temperature -10 °C. 100% Partial load. 2) Local supply.

\* Controllers: PAW-CO2-PANEL-C or local supply.

## Refrigeration designer available in Panasonic PRO Club.

This simple design tool supports engineers, installers, and technicians to make a quick calculation for commercial refrigeration systems.

- Evaporation temperature selection
- Cooling capacity calculator
- Refrigerant pipe calculation
- Electric expansion valves calculation
- Refrigerant amount calculation

Ready to works on all devices, computers, tablets and smartphones!!

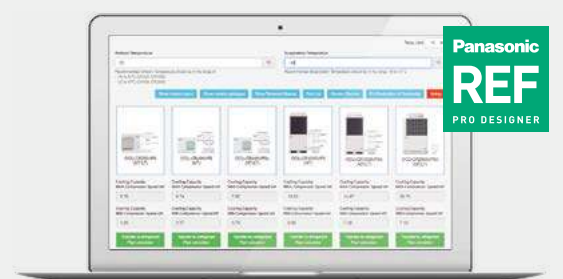

PRO Club

www.panasonicproclub.com or  
connect simply with your smartphone  
to the PRO Club using this QR



## Control and connectivity

Panasonic CO<sub>2</sub> condensing units - CR Series is optimized with Panel-C intelligent controller and a service checker for professionals. It can be easily integrated with major monitoring systems.



### Modbus compatibility with monitoring system

Panasonic CO<sub>2</sub> condensing units - CR Series can be supervised by major monitoring system such as CAREL, Eliwell, COPELAND, Danfoss, RDM and Pego. Monitoring system ensures the recording, monitoring and reporting of temperature conditions etc... of entire CO<sub>2</sub> condensing units - CR Series system at shops.

#### Monitoring system



Standard boss & boss-mini



AK-SM Series\*



TelevisGo

Copeland Controls



Xweb



DMTOUCH



TeleNET

\* M2M1-10 gateway (Model code: FDS021) is required in addition to the monitoring system. M2M1-10 gateway is a local supply.



## Control panel and electric expansion valves.

Panel-C, an intelligent controller with a compact chassis. This controller has the smart program especially for showcases and cold rooms. Electric expansion valves (EEVs) are ready with 8 different sizes to meet precisely the field demand and it's delivered with Panel-C as a kit.

### Intelligent controller with compact chassis. Panel-C.

- MPXPRO control fully pre-programmed for MT and LT on the same panel
- Compact structure size: 300 x 220 x 120 mm
- Necessary cables, EEV stator, temperature and pressure probes as standard equipment
- Ultracap technology as standard equipment for emergency EEV's closing in the event of mains power failure
- Smart defrost functions, advanced superheat control, light and showcase curtain management, etc
- Own display user terminal plus keypad for programming, built-in switching power supply, Modbus, etc
- Management of HACCP alarms

### Electric expansion valves (EEVs) line-up.

- EEV's E2V-CW with 3/8" ODF copper fittings for high pressure applications (CO<sub>2</sub>)
- Operation refrigerant temperature: -40 T 70 °C
- Maximum operating pressure for all the models 03, 05, 09, 11, 14, 18, 24 and 30 (MOP) 140 bar
- Maximum operating pressure difference for 03, 05, 09, 11, 14, 18, (MOPD) 120 bar, 24 (MOPD) 85 bar, and 30 (MOPD) 90 bar
- Bipolar stator hermetic IP69K as standard equipment (supplied on panel)
- Mechanical strainer as standard equipment (500 mm mesh)
- Equipercetile control particularly effective at partial load with reliable operation even after 1,2 billion steps

\* Please refer the model references in page 620.



## CO<sub>2</sub> service checker

### PAW-CO2-CHECKER

The service checker is a useful tool which supports your technical tasks on the field such as commissioning, maintenance and troubleshooting for Panasonic CO<sub>2</sub> condensing units - CR Series.

#### Main features:

- Reading and recording variable technical parameters
- Main technical parameters available\*: pressures, temperatures, opening of expansion valves, states of solenoid valves, rotational speeds of the gas-cooler fan motor, frequency and compressor's current, etc.
- Setting change of operating values possible
- 2D graph visualization for the detailed analysis
- Monitoring an alarm status, for example the status of the compressor oil level, etc.

\* Please check all the parameters available in the manual.

**To use it, is necessary to download free Device Manager software from the Eliwell website:**

Visit: <https://www.eliwell.com/en/Family/DeviceManager.html> using this QR.

Eliwell product name: Device Manager 100. Eliwell part number: DMP1000002000.



**eliwell**  
by Schneider Electric

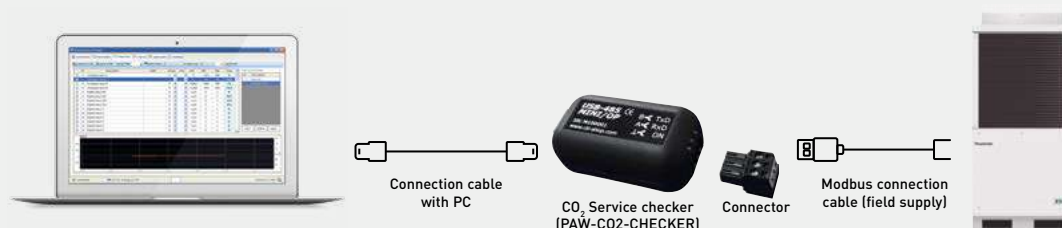

## Range of CO<sub>2</sub> condensing units - CR Series

Outdoor units	MT	4,0 kW	7,0 kW	8,0 kW	15,0 kW	16,0 kW	29,0 kW
	LT		2,0 kW		4,0 kW		8,0 kW

2 HP MT / LT  
(200VF5A)



OCU-CR200VF5A  
OCU-CR200VF5ASL

4 HP MT  
(400VF8)



OCU-CR400VF8  
OCU-CR400VF8SL

4 HP MT / LT  
(400VF8A)



OCU-CR400VF8A  
OCU-CR400VF8ASL

10 HP MT  
(1000VF8)



OCU-CR1000VF8  
OCU-CR1000VF8SL

10 HP MT / LT  
(1000VF8A)



OCU-CR1000VF8A  
OCU-CR1000VF8ASL

20 HP MT / LT  
(2000VF8A)



OCU-CR2000VF8A  
OCU-CR2000VF8ASL

# Accessories and control

## Control panel and electric expansion valves







### Control panel (Panel-C) with electric expansion valves (EEV) included.



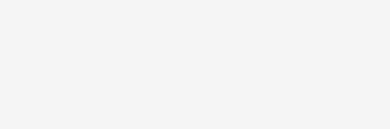
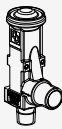
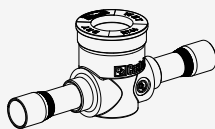
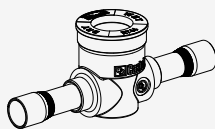
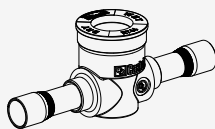
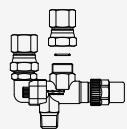
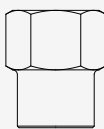
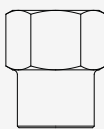

Panel-C includes MPXPRO control, stator, probes, etc.

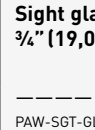
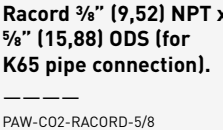
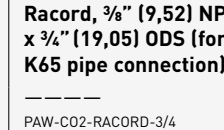
EEV size E2V03CWAC0.	EEV size E2V05CWAC0.	EEV size E2V09CWAC0.	EEV size E2V11CWAC0.	EEV size E2V14CWAC0.	EEV size E2V18CWAC0.	EEV size E2V24CWAC0.	EEV size E3V30CWM00.
----- KIT-CO2-PANEL-C-03	----- KIT-CO2-PANEL-C-05	----- KIT-CO2-PANEL-C-09	----- KIT-CO2-PANEL-C-11	----- KIT-CO2-PANEL-C-14	----- KIT-CO2-PANEL-C-18	----- KIT-CO2-PANEL-C-24	----- KIT-CO2-PANEL-C-30

## Accessories

 <p><b>Service adaptor for vacuum and service (HP and LP port) for all outdoor units*.</b></p> <p>----- SPK-TU125</p>	 <p><b>Lubrication Oil PZ-68S (0,5L) for all outdoor units**.</b></p> <p>----- CZ-CO2LBR0L500</p>	 <p><b>Pressure release valve (PRV) 3/8" (9,52) NPT x G 1/2" (12,70) Pset= 80,0 bar (PRV for suction line all outdoor units or PRV for liquid receiver only for 400VF8(A), 1000VF8(A) and 2000VF8A).</b></p> <p>----- PAW-CO2-PRV80</p>	 <p><b>Pressure release valve (PRV) 3/8" (9,52) NPT x G 1/2" (12,70) Pset= 120,0 bar (PRV for liquid receiver, only for the 200VF5A).</b></p> <p>----- PAW-CO2-PRV120</p>		
 <p><b>Sight glass, 130 bar, 1/4" (6,35) ODS.</b></p> <p>----- PAW-SGT-GLASS-1/4</p>	 <p><b>Sight glass, 130 bar, 3/8" (9,52) ODS.</b></p> <p>----- PAW-SGT-GLASS-3/8</p>	 <p><b>Sight glass, 130 bar, 1/2" (12,70) ODS.</b></p> <p>----- PAW-SGT-GLASS-1/2</p>	 <p><b>Changeover valve, 3/8" (9,52) NPT x 3/8" (9,52) NPT.</b></p> <p>----- PAW-CO2-CHANGE-0</p>	 <p><b>Racord 3/8" (9,52) NPT x 3/8" (9,52) ODS (for K65 pipe connection).</b></p> <p>----- PAW-CO2-RACORD-3/8</p>	 <p><b>Racord 3/8" (9,52) NPT x 1/2" (12,70) ODS (for K65 pipe connection).</b></p> <p>----- PAW-CO2-RACORD-1/2</p>
 <p><b>Sight glass, 130 bar, 5/8" (15,88) - 16 mm ODS.</b></p> <p>----- PAW-SGT-GLASS-5/8</p>	 <p><b>Sight glass, 130 bar, 3/4" (19,05) ODS.</b></p> <p>----- PAW-SGT-GLASS-3/4</p>			 <p><b>Racord 3/8" (9,52) NPT x 5/8" (15,88) ODS (for K65 pipe connection).</b></p> <p>----- PAW-CO2-RACORD-5/8</p>	 <p><b>Racord, 3/8" (9,52) NPT x 3/4" (19,05) ODS (for K65 pipe connection).</b></p> <p>----- PAW-CO2-RACORD-3/4</p>

## CO<sub>2</sub> service checker

 <p><b>CO<sub>2</sub> service checker for commissioning, maintenance and troubleshooting.</b></p> <p>----- PAW-CO2-CHECKER</p>	 <p><b>NEW S-006T suction filter, 3/4" (19,05) (outer Ø welding) for 400VF8(A)***.</b></p> <p>----- 80203514142000</p>	 <p><b>S-008T1 suction filter, 3/4" (19,05) (outer Ø welding) for 1000VF8(A) and 2000VF8A.</b></p> <p>----- 80203514139000 <sup>1)</sup></p>	 <p><b>D-155T filter dryer, 5/8" (15,88) (in Ø welding) (type CO-085-S) for 1000VF8(A) and 2000VF8A.</b></p> <p>----- 80203513180000 <sup>2)</sup></p>	 <p><b>DCY-P8 165 S filter dryer, 5/8" (16,10) (in Ø welding) for 1000VF8(A) and 2000VF8A.</b></p> <p>----- 80203513187000 <sup>3)</sup></p>	 <p><b>D-152T filter dryer, 1/4" (6,35) (in Ø welding) (type CO-082-S) for 200VF5A and 400VF8(A).</b></p> <p>----- 80203513179000 <sup>4)</sup></p>	 <p><b>NEW DCY-P8 093S filter dryer, 3/8" (9,60) (in Ø welding) for 400VF8(A).</b></p> <p>----- 80203513190000</p>	 <p><b>DCY-P12 092 S filter dryer, 1/4" (6,40) (in Ø welding) for 200VF5A.</b></p> <p>----- 80203513186000 <sup>5)</sup></p>
---	--	---	--	--	---	---	---

\* 2 pcs. are recommended for the 2000VF8A.

\*\* You can find the PZ-68S oil "Safety Sheet" in the SAFETY section of our pipe selection software, available on our PRO Club platform.

\*\*\* Sample image – actual product appearance may vary.

Compatibility relationship: 2) and 3) are compatible; 4) and 5) are compatible. Stock availability: 2) and 4) until end of stock.

CO<sub>2</sub> condensing units - CR Series

Standard outdoor unit			OCU-CR200VF5A	OCU-CR400VF8	OCU-CR400VF8A		
Anti corrosion coating outdoor unit			OCU-CR200VF5ASL	OCU-CR400VF8SL	OCU-CR400VF8ASL		
Type (MT: medium temperature, LT: low temperature)			MT (4 kW) / LT (2 kW)	MT (7,5 kW)	MT (8 kW) / LT (4 kW)		
Power supply	Voltage	V	220/230/240	380/400/415	380/400/415		
	Phase		Single phase	Three phase	Three phase		
	Frequency	Hz	50	50	50		
Cooling capacity at ET -10 °C AT 32 °C		kW	3,70	6,89	7,52		
Cooling capacity at ET -35 °C AT 32 °C		kW	1,80	—	3,77		
<b>SEPR cooling at ET -10 °C AT 32 °C</b>			<b>3,83</b>	<b>3,17</b>	<b>3,20</b>		
<b>SEPR freezing at ET -35 °C AT 32 °C</b>			<b>1,92</b>	<b>—</b>	<b>1,73</b>		
Annual electricity consumption at ET -10 °C AT 32 °C		kWh/a	6797	13384	14488		
Annual electricity consumption at ET -35 °C AT 32 °C		kWh/a	8021	—	16255		
Evaporator connection			Multiple	Multiple	Multiple		
Evaporation temperature	Min ~ Max	°C	-45 ~ -5	-20 ~ -5	-45 ~ -5		
Ambient temperature	Min ~ Max	°C	-20 ~ +43	-20 ~ +45	-20 ~ +45		
Refrigerant			R744	R744	R744		
Design pressure liquid line		Mpa	12	8	8		
Design pressure suction line		Mpa	8	8	8		
User system external alarm. Digital input. Non-voltage contact			Yes	Yes	Yes		
Liquid tube electromagnetic valve		Vac	220/230/240	220/230/240	220/230/240		
Showcase operation ON / OFF signal. Digital input. Non-voltage contact			Yes	Yes	Yes		
Modbus communication line (RS485)		Ports	Yes	Yes	Yes		
Compressor type			2- stage rotary	2- stage rotary	2- stage rotary		
Dimension	H x W x D	mm	930 x 900 x 437	948 x 1143 x 609	948 x 1143 x 609		
Net weight		Kg	70	136	149		
Piping diameter <sup>1)</sup>	Suction pipe	Inch (mm)	¾(9,52)	½(12,70)	½(12,70)		
	Liquid pipe	Inch (mm)	¼(6,35)	¾(9,52)	¾(9,52)		
Length of connection piping		m	25	50 <sup>2)</sup>	50 <sup>2)</sup>		
PED		CAT	I	II	II		
Air flow		m <sup>3</sup> /min	54	59	59		
External static pressure		Pa	17	50	50		
Heat recovery port			—	—	Yes		
Standard performance	Ambient temperature	°C	32	32	32		
	Evaporating temperature	°C	-10	-35	-10	-35	
	Cooling capacity	kW	3,70	1,80	6,89	7,52	3,77
	Power consumption	kW	1,79	1,65	4,00	4,51	3,69
	Nominal load ampere	A	7,94	7,26	6,14	7,20	6,20
	Sound pressure	dB(A)	35,5 <sup>3)</sup>	35,5 <sup>3)</sup>	33,0 <sup>4)</sup>	36,1 <sup>4)</sup>	36,1 <sup>4)</sup>
<b>Necessary accessories</b>							
Drier filter liquid line, Ø6,35 mm		<b>D-152T / DCY-P12</b>	Yes (included)	—	—		
Drier filter liquid line, Ø15,88 mm		<b>D-155T / DCY-P8</b>	—	Yes (included)	Yes (included)		
Suction filter, Ø19,05 mm (outer Ø welding)		<b>S-008T1 / S-006T</b>	—	Yes (included)	Yes (included)		

1) These diameters correspond to the output of the unit. The required diameter must be calculated with Refrigeration designer available on PRO Club. 2) PZ-68S (refrigeration oil) must be added according to Refrigeration designer available on PRO Club. 3) ET-10 °C, 65 S-1, 10 m from product. 4) ET-10 °C, 80 S-1, 10 m from product.





Standard outdoor unit			OCU-CR1000VF8	OCU-CR1000VF8A	OCU-CR2000VF8A
Anti corrosion coating outdoor unit			OCU-CR1000VF8SL	OCU-CR1000VF8ASL	OCU-CR2000VF8ASL
Type (MT: medium temperature, LT: low temperature)			MT (15 kW)	MT (16 kW) / LT (8 kW)	MT (29 kW) / LT (15 kW)
Power supply	Voltage	V	380/400/415	380/400/415	380/400/415
	Phase		Three phase	Three phase	Three phase
	Frequency	Hz	50	50	50
Cooling capacity at ET -10 °C AT 32 °C		kW	14,00	15,10	28,74
Cooling capacity at ET -35 °C AT 32 °C		kW	—	8,00	14,73
<b>SEPR cooling at ET -10 °C AT 32 °C</b>			<b>2,62</b>	<b>2,86</b>	<b>3,10</b>
<b>SEPR freezing at ET -35 °C AT 32 °C</b>			<b>—</b>	<b>1,49</b>	<b>1,64</b>
Annual electricity consumption at ET -10 °C AT 32 °C		kWh/a	32815	32409	57076
Annual electricity consumption at ET -35 °C AT 32 °C		kWh/a	—	39985	66760
Evaporator connection			Multiple	Multiple	Multiple
Evaporation temperature	Min - Max	°C	-20 ~ -5	-45 ~ -5	-45 ~ -5
Ambient temperature	Min - Max	°C	-20 ~ +43	-20 ~ +43	-20 ~ +45
Refrigerant			R744	R744	R744
Design pressure liquid line		Mpa	8	8	8
Design pressure suction line		Mpa	8	8	8
User system external alarm. Digital input. Non-voltage contact			Yes	Yes	Yes
Liquid tube electromagnetic valve		Vac	220/230/240	220/230/240	—
Showcase operation ON / OFF signal. Digital input. Non-voltage contact			Yes	Yes	Yes
Modbus communication line (RS485)		Ports	Yes	Yes	Yes
Compressor type			2- stage rotary	2- stage rotary	2- stage rotary
Dimension	H x W x D	mm	1941 x 890 x 890	1941 x 890 x 890	1941 x 1190 x 890
Net weight		Kg	293	320	494
Piping diameter <sup>1)</sup>	Suction pipe	Inch (mm)	¾ (19,05)	¾ (19,05)	¾ (22,22)
	Liquid pipe	Inch (mm)	¾ (15,88)	¾ (15,88)	¾ (19,05)
Length of connection piping		m	100 <sup>2)</sup>	100 <sup>2)</sup>	100 <sup>2)</sup>
PED		CAT	II	II	II
Air flow		m <sup>3</sup> /min	220	220	220
External static pressure		Pa	58	58	58
Heat recovery port			—	Yes	Yes
Standard performance	Ambient temperature	°C	32	32	32
	Evaporating temperature	°C	-10	-10	-35
	Cooling capacity	kW	14,00	15,10	8,00
	Power consumption	kW	8,20	8,20	7,57
	Nominal load ampere	A	12,60	12,60	11,60
Sound pressure		dB(A)	36,0 <sup>3)</sup>	36,0 <sup>3)</sup>	36,0 <sup>3)</sup>
<b>Necessary accessories</b>					
Drier filter liquid line, Ø15,88 mm		<b>D-155T / DCY-P8</b>	Yes (included)	Yes (included)	—
Drier filter liquid line, Ø19,05 mm		<b>D-155T / DCY-P8</b>	—	—	Yes (included)
Suction filter, Ø19,05 mm (outer Ø welding)		<b>S-008T1</b>	Yes (included)	Yes (included)	Yes (included)

1) These diameters correspond to the output of the unit. The required diameter must be calculated with Refrigeration designer available on PRO Club. 2) PZ-685 (refrigeration oil) must be added if >50 m. 3) ET -10 °C, 60 S-1, 10 m from product.



## Panasonic PACi NX Elite can cool rooms down to 8 °C

PACi

Panasonic PACi NX Elite offers a high quality and efficient solution for high temperature refrigeration applications for facilities such as wine cellars, food processing facilities and supermarkets.

Cooling rooms between  
8 °C WB and 24 °C WB

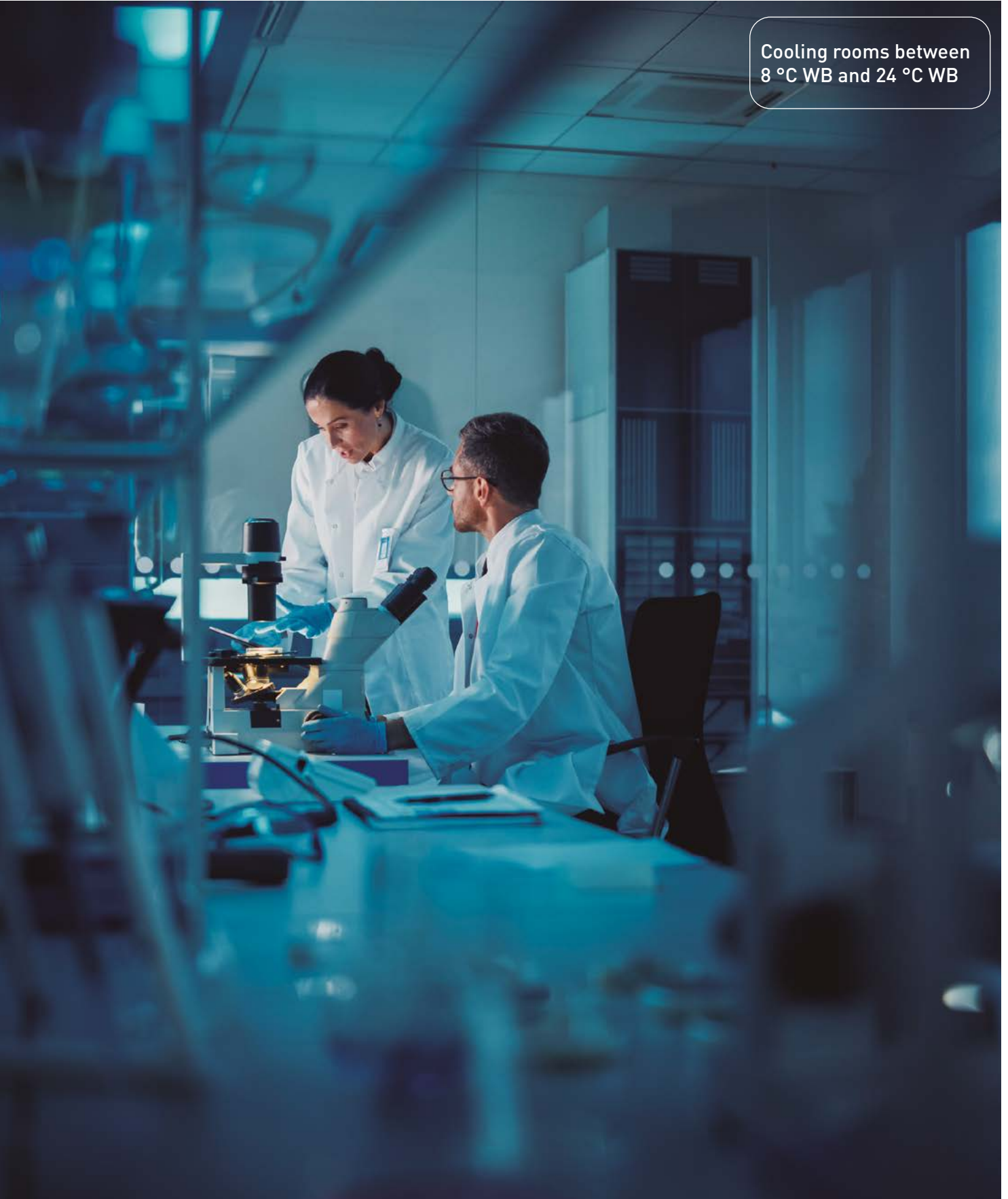

## Solutions for cold rooms. Set the room temperature to 8 °C.

Complete range from 2,10 to 23,77 kW. This unique solution is perfect for:

Wine cellars, ice cream factories, flower shops, supermarkets, grain stores, food storage, food processing, food distribution, lunchrooms, vegetable processing...

Just like all the indoor units in the PACi NX range, these units are compatible with all Panasonic control and monitoring solutions, which can be scaled from controlling a single zone to monitoring geographically distributed facilities.

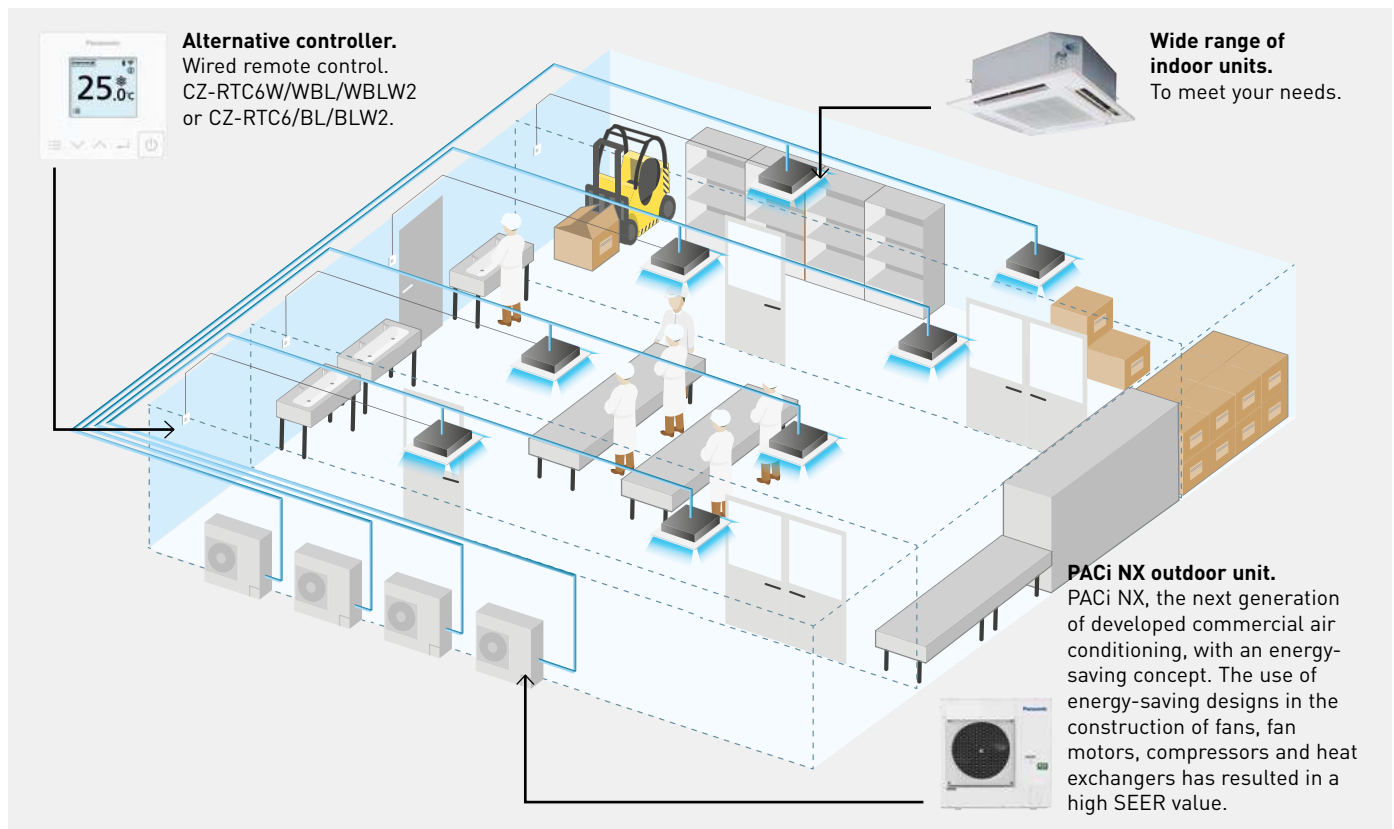

- Flexibility with different type of indoors
- Benefits of hydroxyl radicals
- Out of the box solution from Panasonic. Outdoor, indoor, controller comes as package
- Provides wide scale of control options (individual, central, cloud)
- Redundancy for 2 systems with CONEX controller range and up to 4 indoor unit groups with PAW-PACR4 optional redundancy controller



## Wine cellars and special high temperature rooms

One of the main features of the PACi NX series is the possibility of adjusting the product for special applications, not just for regular cooling applications. The purpose of this product information is to explain in detail these special applications that need a cooling operation to maintain the room temperature at +8 ~ +24 °C WB (or +10 ~ +30 °C DB). In order to do this in terms of enthalpy, the indoor unit needs to be overdimensioned and certain parameters need to be adjustable.

Temperature range for wine cellar		
	Indoor	Outdoor
Cooling operation	+8 ~ +24 °C WB	-5 [-15] ~ 43 °C DB

**Temperature range for wine cellar.**  
In cooling. Outdoor air intake temperature °C DB.

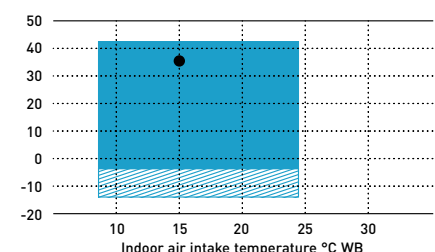

 Only allowed after installation of wind and snow vents.

 Area where cooling capacity is established for this purpose.

# Bringing nature's balance indoors



## nanoe™ X, technology with the benefits of hydroxyl radicals.

Abundant in nature, hydroxyl radicals (also known as OH radicals) have the capacity to inhibit pollutants, viruses, and bacteria to clean and deodorise. nanoe™ X technology can bring these incredible benefits indoors so that hard surfaces, soft furnishings, and the indoor environment can be a cleaner and more pleasant place to be.



### What is unique about nanoe™ X?

**Effective on fabrics and surfaces.**

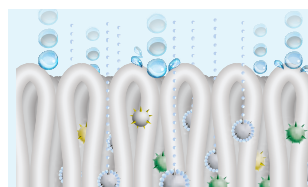

1 | At one billionth of a metre, nanoe™ X is much smaller than steam and can deeply penetrate cloth fabrics to deodorise.

**Longer lifespan.**



2 | Contained in tiny water particles, nanoe™ X has a long lifespan, which is about 600 seconds, to spread easily around the room.

**Huge quantity.**



3 | nanoe X Generator Mark 3 produces 48 trillion hydroxyl radicals per second. Greater amounts of hydroxyl radicals contained in nanoe™ X lead to higher performance on inhibition of pollutants.

**Maintenance-free.**

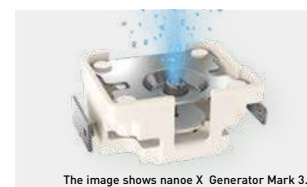

The image shows nanoe X Generator Mark 3.

4 | No service and maintenance required. nanoe™ X is a filter free solution that does not require maintenance, as its atomisation electrode is enveloped with water during its generation process and it is made with Titanium.

### 7 effects of nanoe™ X – Panasonic unique technology

**Deodorises**

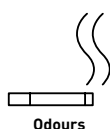

Odours

**Capacity to inhibit 5 types of pollutants**

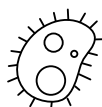

Bacteria and viruses

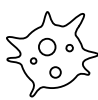

Mould



Allergens



Pollen



Hazardous substances



Skin and hair

\* Refer to <https://aircon.panasonic.eu> for more details and validation data.

### First nanoe™ device was developed by Panasonic in 2003

**Generator: nanoe™**

2003

480 billion hydroxyl radicals/sec

**Ion particle structure**  
Hydroxyl radicals

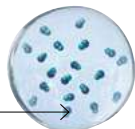

**Generator: nanoe™ X**

**Mark 1 - 2016**

4,8 trillion hydroxyl radicals/sec

10x times

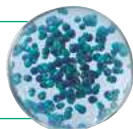

**Mark 2 - 2019**

9,6 trillion hydroxyl radicals/sec

20x times

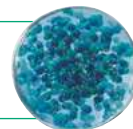

**Mark 3 - 2022**

48 trillion hydroxyl radicals/sec

100x times

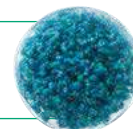



## nanoe™ X, internationally-validated technology in testing facilities.

The effectiveness of nanoe™ X technology has been tested by 3rd party laboratories in Germany, France, Denmark, Japan and China.

The nanoe™ X performance varies depending on the room size, environment and usage and it may take several hours to reach the full effect. nanoe™ X is not medical device, local regulations on building design and sanitary recommendations must be followed. Test results conducted under controlled laboratory conditions. Performance of nanoe™ X might differ in real life environment.

	Tested contents	Generator	Result	Capacity	Time	Testing organisation	Report No.	
Airborne	Virus	Influenza (H1N1)	98,3% inhibited	30 m³	1,5 h	China Electronic Product Reliability and Environmental Testing Research Institute	J2003WT8888-00889	
		Bacteriophage ΦX174	99,2% inhibited	Approx. 25 m³	6 h	Kitasato Research Center for Environmental Science	24_0300_1	
	Bacteria	Staphylococcus aureus	99,7% inhibited	Approx. 25 m³	4 h	Kitasato Research Center for Environmental Science	24_0301_1	
Adhering	Virus	SARS-CoV-2	91,4% inhibited	6,7 m³	8 h	Texcell (France)	1140-01 C3	
		SARS-CoV-2	99,9% inhibited	45 L	2 h	Texcell (France)	1140-01 A1	
		Bacteriophage ΦX174	99,8% inhibited	Approx. 25 m³	8 h	Japan Food Research Laboratories	13001265005-01	
		Xenotropic murine leukemia virus	99,999% inhibited	45 L	6 h	Charles River Biopharmaceutical Services GmbH	—	
		Coxsackie virus (CA16)	99,9%inhibited	30 m³	4 h	China Electronic Product Reliability and Environmental Testing Research Institute	J2002WT8888-00439	
		Bacteriophage	<b>Mark 3</b>	98,81% inhibited	Approx. 139,3 m³	4 h	SGS Inc	SHES210901902584
	Bacteria	MS2 Phage Virus	<b>Mark 3</b>	99,99% inhibited	Approx. 25 m³	2 h	Shokukanken, Inc.	227131N
		Staphylococcus aureus	Mark 1	99,9% inhibited	20 m³	8 h	Danish Technological Institute	868988
	Pollen	Cedar pollen	<b>Mark 3</b>	99%inhibited	Approx. 24 m³	12 h	Panasonic Product Analysis Center	H21YA017-1
		Ambrosia pollen	Mark 1	99,4% inhibited	20 m³	8 h	Danish Technological Institute	868988
	Odours	Cigarette smoke odour	Mark 1	Odour intensity reduced by 2,4 levels	Approx. 23 m³	0,2 h	Panasonic Product Analysis Center	4AA33-160615-N04
			<b>Mark 3</b>	Odour intensity reduced 1,7 levels	Approx. 139,3 m³	0,5 h	SGS Inc	SHES210901902478

### Licensed in VDI 6022

Certification of a HVAC system under VDI 6022 guarantees that the system fulfills the market's strictest hygiene requirements.



#### VDI 6022 – Part 5 <sup>1)</sup> Certification.

##### Avoidance of allergenic exposure.

Inhibits a wide range of harmful bacteria, viruses, mould, pollen and allergens.



#### VDI 6022 – Part 1 <sup>1)</sup> & 1.1 <sup>2)</sup> Certification.

##### Ventilation and indoor-air quality.

Panasonic nanoe™ X technology improving indoor air quality.

1) Certification mark only valid for nanoe X Generator Mark 3. 2) Certification mark only valid for nanoe X Generator Mark 2 and Mark 3.

## nanoe™ X: improving protection 24/7



Acts to clean the work area, such as meat or fish handling in hotel kitchens, food handling in industrial processes, laboratories, wine cellars, etc. So that the indoor environment can be a cleaner and more pleasant place to be all day long and keep the processes in better bacterial conditions.

nanoe™ X works together with the cooling function when during the day but can work independently when the area is not occupied.

Give the system the strength to increase the protection of persons, air, colds stuffs and working surfaces with nanoe™ X technology and convenient control via the Panasonic Comfort Cloud App.

#### Cleans the air even when there is no work activity.

Leave the nanoe™ X mode ON to inhibit certain pollutants and deodorize before start the work activity again.

#### Improves your environment and better protects the products handled when you are or not at work.

Enjoy a cleaner comfortable space both when working indoors and simply when it comes to better protecting products in the cold room.



### Panasonic Heating & Cooling Solutions is incorporating nanoe™ technology in a wide range of equipment



**Wall-mounted.  
Built-in nanoe X Generator Mark 3.**



**Ceiling.  
Built-in nanoe X Generator Mark 2.**



**4 Way 90x90 cassette.  
Built-in nanoe X Generator Mark 1.**



**Adaptive ducted unit.  
Built-in nanoe X Generator Mark 2.**

**NEW PACi NX Series Elite wall-mounted - PK4 - R32**

For light refrigeration applications.

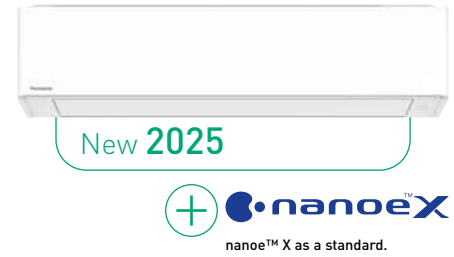

Kit		High temperature									
		36	50	60	71	100	125	140			
Indoor unit - 1		S-5010PK4E	S-5010PK4E	S-5010PK4E	S-5010PK4E	S-5010PK4E	S-5010PK4E	S-5010PK4E			
Indoor unit - 2					S-5010PK4E	S-5010PK4E	S-5010PK4E	S-5010PK4E			
Outdoor unit		U-36PZH3E5	U-50PZH3E5	U-60PZH3E5	U-71PZH4E5/8	U-100PZH4E5/8	U-125PZH4E5/8	U-140PZH4E5/8			
Outdoor 35 °C (DB)	Indoor 15 °C (WB)	Cooling capacity	kW	3,50	4,90	5,80	6,90	8,80	11,60	13,00	
		EER		4,27	3,83	3,45	3,40	3,15	3,41	3,61	
		Input power	kW	0,82	1,28	1,68	2,03	2,79	3,40	3,60	
	Indoor 12 °C (WB)	Cooling capacity	kW	3,19	4,46	5,28	6,28	8,01	10,56	11,83	
		EER		3,96	3,55	3,21	3,16	2,93	3,17	3,35	
		Input power	kW	0,80	1,25	1,65	1,99	2,73	3,33	3,53	
	Indoor 8 °C (WB)	Cooling capacity	kW	2,10	2,94	3,48	4,14	5,28	6,96	7,80	
		EER		3,28	2,94	2,66	2,62	2,42	2,62	2,78	
		Input power	kW	0,64	1,00	1,31	1,58	2,18	2,65	2,81	
	Outdoor 30 °C (DB)	Indoor 15 °C (WB)	Cooling capacity	kW	3,75	5,24	5,92	7,04	9,42	12,41	13,91
			EER		4,96	4,45	3,75	3,69	3,66	3,97	4,20
			Input power	kW	0,75	1,18	1,58	1,91	2,57	3,13	3,31
Indoor 12 °C (WB)		Cooling capacity	kW	3,43	4,80	5,39	6,42	8,62	11,37	12,74	
		EER		4,65	4,17	3,49	3,44	3,43	3,71	3,93	
		Input power	kW	0,74	1,15	1,55	1,87	2,51	3,06	3,24	
Indoor 8 °C (WB)		Cooling capacity	kW	2,10	2,94	3,48	4,14	5,28	6,96	7,80	
		EER		3,66	3,28	2,88	2,83	2,70	2,92	3,09	
		Input power	kW	0,57	0,90	1,21	1,46	2,15	2,38	2,52	
Indoor unit		Dimension (HxWxD)	mm	295 x 1060 x 249	295 x 1060 x 249	295 x 1060 x 249	295 x 1060 x 249	295 x 1060 x 249	295 x 1060 x 249	295 x 1060 x 249	
		Net weight	kg	14	14	14	14	14	14	14	
		nanoe X Generator		Mark 3	Mark 3	Mark 3	Mark 3	Mark 3	Mark 3	Mark 3	
Outdoor unit	Dimension (HxWxD)	mm	695 x 875 x 320	695 x 875 x 320	695 x 875 x 320	996 x 980 x 370	996 x 980 x 370	996 x 980 x 370	996 x 980 x 370		
	Net weight	kg	42	42	43	66	84	86	86		

**Accessories**

<b>CZ-RTC6W</b>	CONEX wired remote controller (non-wireless), white
<b>CZ-RTC6WBL</b>	CONEX wired remote controller with Bluetooth®, white
<b>CZ-RTC6WBLW2</b>	CONEX wired remote controller with Wi-Fi and Bluetooth®, white
<b>CZ-RTC6</b>	CONEX wired remote controller (non-wireless), black
<b>CZ-RTC6BL</b>	CONEX wired remote controller with Bluetooth®, black
<b>CZ-RTC6BLW2</b>	CONEX wired remote controller with Wi-Fi and Bluetooth®, black
<b>CZ-RTC5B</b>	Wired remote controller with Econavi function
<b>CZ-RW53</b>	Infrared remote controller

**Accessories**

<b>PAW-PACR4</b>	Interface to run up to 4 indoor unit groups on backup and alternative run
<b>PAW-WTRAY</b>	Tray for condenser water compatible with outdoor elevation platform
<b>PAW-GRDBSE20</b>	Outdoor base ground support for noise and vibration absorption
<b>PAW-GRDSTD40</b>	Outdoor elevation platform 400 x 900 x 400 mm
<b>CZ-CENSC1</b>	Econavi energy saving sensor

**Technical focus**

- Modern, flat design with a stylish matte white finish featuring
- DC fan for better efficiency and control
- Five-direction automatic airflow adjustment for cooling and heating
- Six directional piping outlet
- Quiet operation
- nanoe™ X (Generator Mark 3: 48 trillion hydroxyl radicals/sec) as standard for better indoor air quality
- Wired remote control CZ-RTC6WBL and CZ-RTC6BL allows easy system setting via Bluetooth®
- Easy connection and control of external fan or ERV using the connector PAW-FDC on the indoor unit PCB. The external device can be controlled by the remote control of the Panasonic indoor unit

**Closed discharge port**

When the unit is turned OFF, the flap closes completely to prevent dust getting into the unit and to keep the equipment clean.

**Piping outlet in six directions**

Piping outlet is possible in six directions of; right, right rear, right bottom, left, left rear and left bottom, making the installation work more flexible.

**Air distribution is automatically altered depending on the operational mode of the unit**

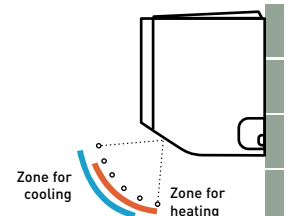

## PACi NX Series Elite 4 way 90x90 cassette - PU3 · R32

For light refrigeration applications.



Standard panel, white (RAL9003). CZ-KPU3

**nanoe™ X** as a standard.

		High temperature											
Kit		36	50	60	71	100	125	140	200	250			
Indoor unit - 1		S-6071PU3E	S-6071PU3E	S-1014PU3E	S-1014PU3E	S-1014PU3E	S-1014PU3E	S-1014PU3E	S-1014PU3E	S-1014PU3E			
Indoor unit - 2		—	—	—	—	—	—	S-1014PU3E	S-1014PU3E	S-1014PU3E			
Outdoor unit		U-36PZH3E5	U-50PZH3E5	U-60PZH3E5	U-71PZH4E5/8	U-100PZH4E5/8	U-125PZH4E5/8	U-140PZH4E5/8	U-200PZH4E8	U-250PZH4E8			
Outdoor 35 °C (DB)	Indoor 15 °C (WB)	Cooling capacity	kW	3,50	4,90	5,80	6,90	8,80	11,60	13,00	18,50	23,20	
		EER		5,12	4,05	3,81	3,67	4,09	3,47	3,82	3,38	2,97	
		Input power	kW	0,68	1,21	1,52	1,88	2,15	3,34	3,40	5,48	7,82	
	Indoor 12 °C (WB)	Cooling capacity	kW	3,19	4,46	5,28	6,28	8,01	10,56	11,83	16,84	21,11	
		EER		4,78	3,76	3,54	3,41	3,80	3,22	3,55	3,13	2,75	
		Input power	kW	0,67	1,19	1,49	1,84	2,11	3,27	3,33	5,37	7,66	
	Indoor 8 °C (WB)	Cooling capacity	kW	2,10	2,94	3,48	4,14	5,28	6,96	7,80	11,10	13,92	
		EER		3,96	3,12	2,94	2,82	3,15	2,67	2,94	2,60	2,28	
		Input power	kW	0,53	0,94	1,19	1,47	1,68	2,61	2,65	4,27	6,10	
	Outdoor 30 °C (DB)	Indoor 15 °C (WB)	Cooling capacity	kW	3,75	5,24	5,92	7,04	9,42	12,41	13,91	20,17	25,29
			EER		5,99	4,71	4,14	3,98	4,76	4,04	4,45	4,00	3,51
			Input power	kW	0,63	1,11	1,43	1,77	1,98	3,07	3,13	5,04	7,19
Indoor 12 °C (WB)		Cooling capacity	kW	3,43	4,80	5,39	6,42	8,62	12,41	12,74	18,50	23,20	
		EER		5,60	4,41	3,86	3,71	4,46	4,04	4,16	3,75	3,30	
		Input power	kW	0,61	1,09	1,40	1,73	1,94	3,07	3,06	4,93	7,04	
Indoor 8 °C (WB)	Cooling capacity	kW	2,10	2,94	3,48	4,14	5,28	6,96	7,80	11,10	13,92		
	EER		4,41	3,47	3,18	3,06	3,51	2,98	3,28	2,89	2,54		
	Input power	kW	0,48	0,85	1,09	1,35	1,51	2,34	2,38	3,84	5,47		
Indoor unit		Dimension (HxWxD)	mm	256x840x840	256x840x840	256x840x840	319x840x840	319x840x840	319x840x840	319x840x840	319x840x840	319x840x840	
		Net weight	kg	19	19	20	25	25	25	25	25	25	
		nanoe X Generator		Mark 1	Mark 1	Mark 1	Mark 1	Mark 1	Mark 1	Mark 1	Mark 1	Mark 1	
Outdoor unit		Dimension (HxWxD)	mm	695x875x320	695x875x320	695x875x320	996x980x370	996x980x370	996x980x370	996x980x370	996x1140x460	996x1140x460	
		Net weight	kg	42	42	43	66	84	86	86	109	109	

### Accessories

<b>CZ-RTC6W</b>	CONEX wired remote controller (non-wireless), white
<b>CZ-RTC6WBL</b>	CONEX wired remote controller with Bluetooth®, white
<b>CZ-RTC6BLW2</b>	CONEX wired remote controller with Wi-Fi and Bluetooth®, white
<b>CZ-RTC6</b>	CONEX wired remote controller (non-wireless), black
<b>CZ-RTC6BL</b>	CONEX wired remote controller with Bluetooth®, black
<b>CZ-RTC6BLW2</b>	CONEX wired remote controller with Wi-Fi and Bluetooth®, black
<b>CZ-RTC5B</b>	Wired remote controller with Econavi function
<b>CZ-RWS3 + CZ-RWRU3</b>	Infrared remote controller and receiver

### Accessories

<b>CZ-KPU3A</b>	Econavi exclusive panel, white (RAL9003)
<b>CZ-KPU3B</b>	<b>NEW</b> Standard panel, graphite black (RAL9011)
<b>PAW-WTRAY</b>	Tray for condenser water compatible with outdoor elevation platform
<b>PAW-GRDBSE20</b>	Outdoor base ground support for noise and vibration absorption
<b>PAW-GRDSTD40</b>	Outdoor elevation platform 400x900x400 mm
<b>CZ-FDU3+CZ-ATU2</b>	Fresh air-intake kit

### Technical focus

- High performance turbo fan
- Econavi: An optional intelligent sensor to reduce waste of energy
- nanoe™ X (Generator Mark 1: 4,8 trillion hydroxyl radicals/sec) as standard for better indoor air quality, indoor unit internal cleaning with nanoe™ X plus dry operation
- **NEW** graphite black and white panels providing options to suit a variety of light commercial applications
- Lower noise in low fan operation
- Light weight, easy piping and integrated drain pump for quick installation
- Wired remote control CZ-RTC6WBL and CZ-RTC6BL allows easy system setting via Bluetooth®
- High volume fresh air input with optional air-intake plenum and chamber (CZ-FDU3+CZ-ATU2)

### White and graphite black panels available for the 4 way 90x90 cassette.

Standard panel, white (RAL9003).

CZ-KPU3



Econavi panel, white (RAL9003).

CZ-KPU3A



Standard panel, graphite black (RAL9011).

CZ-KPU3B



## PACi NX Series Elite ceiling - PT3 · R32

For light refrigeration applications.



Kit		High temperature											
		36	50	60	71	100	125	140	200	250			
Indoor unit - 1		S-6071PT3E	S-6071PT3E	S-1014PT3E	S-1014PT3E	S-1014PT3E	S-1014PT3E	S-1014PT3E	S-1014PT3E	S-1014PT3E			
Indoor unit - 2		—	—	—	—	—	—	S-1014PT3E	S-1014PT3E	S-1014PT3E			
Outdoor unit		U-36PZH3E5	U-50PZH3E5	U-60PZH3E5	U-71PZH4E5/8	U-100PZH4E5/8	U-125PZH4E5/8	U-140PZH4E5/8	U-200PZH4E8	U-250PZH4E8			
Outdoor 35 °C (DB)	Indoor 15 °C (WB)	Cooling capacity	kW	3,50	4,90	5,80	6,60	8,80	11,20	13,00	18,50	23,20	
		EER		4,67	3,71	3,63	3,53	3,76	3,15	3,40	3,32	2,92	
		Input power	kW	0,75	1,32	1,60	1,87	2,34	3,56	3,82	5,57	7,94	
	Indoor 12 °C (WB)	Cooling capacity	kW	3,19	4,46	5,28	6,01	8,01	10,19	11,83	16,84	21,11	
		EER		4,33	3,45	3,37	3,28	3,49	2,92	3,16	3,08	2,71	
		Input power	kW	0,74	1,29	1,57	1,83	2,29	3,49	3,74	5,46	7,78	
	Indoor 8 °C (WB)	Cooling capacity	kW	2,10	2,94	3,48	3,96	5,28	6,72	7,80	11,10	13,92	
		EER		3,59	2,86	2,79	2,71	2,89	2,42	2,62	2,55	2,25	
		Input power	kW	0,59	1,03	1,25	1,46	1,83	2,78	2,98	4,34	6,19	
	Outdoor 30 °C (DB)	Indoor 15 °C (WB)	Cooling capacity	kW	3,75	5,24	5,92	6,73	9,42	11,98	13,91	20,17	25,29
			EER		5,43	4,32	3,93	3,83	4,37	3,66	3,96	3,94	3,46
			Input power	kW	0,69	1,21	1,50	1,76	2,15	3,28	3,51	5,12	7,30
Indoor 12 °C (WB)		Cooling capacity	kW	3,43	4,80	5,39	6,14	8,62	10,98	12,74	18,50	23,20	
		EER		5,08	4,04	3,66	3,57	4,09	3,43	3,71	3,69	3,25	
		Input power	kW	0,68	1,19	1,47	1,72	2,11	3,20	3,44	5,01	7,15	
Indoor 8 °C (WB)		Cooling capacity	kW	2,10	2,94	3,48	3,96	5,28	6,72	7,80	11,10	13,92	
		EER		4,00	3,18	3,02	2,94	3,22	2,70	2,92	2,85	2,50	
		Input power	kW	0,53	0,92	1,15	1,35	1,64	2,49	2,67	3,90	5,56	
Indoor unit		Dimension (HxWxD)	mm	235x1275x690	235x1275x690	235x1590x690	235x1590x690	235x1590x690	235x1590x690	235x1590x690	235x1590x690	235x1590x690	
		Net weight	kg	34	34	40	40	40	40	40	40	40	
		nanoe X Generator		Mark 2	Mark 2	Mark 2	Mark 2	Mark 2	Mark 2	Mark 2	Mark 2	Mark 2	
Outdoor unit	Dimension (HxWxD)	mm	695x875x320	695x875x320	695x875x320	996x980x370	996x980x370	996x980x370	996x980x370	996x1140x460	996x1140x460		
	Net weight	kg	42	42	43	66	84	86	86	109	109		

Accessories	
<b>CZ-RTC6W</b>	CONEX wired remote controller (non-wireless), white
<b>CZ-RTC6WBL</b>	CONEX wired remote controller with Bluetooth®, white
<b>CZ-RTC6WBLW2</b>	CONEX wired remote controller with Wi-Fi and Bluetooth®, white
<b>CZ-RTC6</b>	CONEX wired remote controller (non-wireless), black
<b>CZ-RTC6BL</b>	CONEX wired remote controller with Bluetooth®, black
<b>CZ-RTC6BLW2</b>	CONEX wired remote controller with Wi-Fi and Bluetooth®, black
<b>CZ-RTC5B</b>	Wired remote controller with Econavi function

## Technical focus

- Wide air distribution for large rooms
- Horizontal air flow reaches maximum 9,5 m
- Fresh air connection available on the unit
- Slim design with 235 mm height fits narrow space
- Silent operation
- nanoe™ X (Generator Mark 2: 9,6 trillion hydroxyl radicals/sec) as standard for better indoor air quality
- Wired remote control CZ-RTC6WBL and CZ-RTC6BL allows easy system setting via Bluetooth®
- Twin, Triple and Double-twin split options
- Easy connection and control of external fan or ERV using the connector PAW-FDC on the indoor unit PCB. The external device can be controlled by the remote control of the Panasonic indoor unit

Accessories	
<b>CZ-RWS3 + CZ-RWRT3</b>	Infrared remote controller and receiver
<b>PAW-WTRAY</b>	Tray for condenser water compatible with outdoor elevation platform
<b>PAW-GRDBSE20</b>	Outdoor base ground support for noise and vibration absorption
<b>PAW-GRDSTD40</b>	Outdoor elevation platform 400x900x400 mm
<b>CZ-CENSC1</b>	Econavi energy saving sensor

## Further comfort improvement with air flow distribution

Horizontal air flow reaches maximum 9,5 m. This is ideal for wide rooms.

The wide air discharge opening expands the air flow to the left and right. The unpleasant feeling caused when the air flow directly hits the human body is prevented by the "Draft prevention position", which changes the swing width, increasing the degree of comfort.

## PACi NX Series Elite adaptive ducted unit - PF3 · R32

For light refrigeration applications.



		High temperature											
Kit			36	50	60	71	100	125	140	200	250		
Indoor unit - 1			S-6071PF3E	S-6071PF3E	S-1014PF3E	S-1014PF3E	S-1014PF3E	S-1014PF3E	S-1014PF3E	S-1014PF3E	S-1014PF3E		
Indoor unit - 2			—	—	—	—	—	—	S-1014PF3E	S-1014PF3E	S-1014PF3E		
Outdoor unit			U-36PZH3E5	U-50PZH3E5	U-60PZH3E5	U-71PZH4E5/8	U-100PZH4E5/8	U-125PZH4E5/8	U-140PZH4E5/8	U-200PZH4E8	U-250PZH4E8		
Outdoor 35 °C (DB)	Indoor 15 °C (WB)	Cooling capacity	kW	3,50	4,90	5,80	6,60	8,80	11,20	13,00	18,50	23,20	
		EER		3,98	3,20	3,52	3,37	3,79	3,21	3,59	3,50	3,08	
		Input power	kW	0,88	1,53	1,65	1,96	2,32	3,49	3,62	5,29	7,54	
	Indoor 12 °C (WB)	Cooling capacity	kW	3,19	4,46	5,28	6,01	8,01	10,19	11,83	16,84	21,11	
		EER		3,69	2,97	3,26	3,13	3,52	2,98	3,33	3,25	2,86	
		Input power	kW	0,86	1,50	1,62	1,92	2,27	3,42	3,55	5,18	7,39	
	Indoor 8 °C (WB)	Cooling capacity	kW	2,10	2,94	3,48	3,96	5,28	6,72	7,80	11,10	13,92	
		EER		3,06	2,46	2,70	2,59	2,92	2,47	2,76	2,69	2,37	
		Input power	kW	0,69	1,19	1,29	1,53	1,81	2,72	2,82	4,13	5,88	
	Outdoor 30 °C (DB)	Indoor 15 °C (WB)	Cooling capacity	kW	3,75	5,24	5,92	6,73	9,42	11,98	13,91	20,17	25,29
			EER		4,63	3,72	3,81	3,65	4,41	3,73	4,18	4,14	3,65
			Input power	kW	0,81	1,41	1,55	1,84	2,13	3,21	3,33	4,87	6,94
Indoor 12 °C (WB)		Cooling capacity	kW	3,43	4,80	5,39	6,14	8,62	10,98	12,74	18,50	23,20	
		EER		4,33	3,49	3,55	3,40	4,13	3,49	3,91	3,89	3,42	
		Input power	kW	0,79	1,38	1,52	1,80	2,09	3,14	3,26	4,76	6,79	
Indoor 8 °C (WB)	Cooling capacity	kW	2,10	2,94	3,48	3,96	5,28	6,72	7,80	11,10	13,92		
	EER		3,41	2,75	2,93	2,81	3,25	2,75	3,08	3,00	2,64		
	Input power	kW	0,62	1,07	1,19	1,41	1,62	2,44	2,53	3,70	5,28		
Indoor unit	Dimension (HxWxD)	mm	250x1000x730	250x1000x730	250x1000x730	250x1400x730	250x1400x730	250x1400x730	250x1400x730	250x1400x730	250x1400x730		
	Net weight	kg	30	30	30	39	39	39	39	39	39		
	nanoe X Generator		Mark 2	Mark 2	Mark 2	Mark 2	Mark 2	Mark 2	Mark 2	Mark 2	Mark 2		
Outdoor unit	Dimension (HxWxD)	mm	695x875x320	695x875x320	695x875x320	996x980x370	996x980x370	996x980x370	996x980x370	996x1140x460	996x1140x460		
	Net weight	kg	42	42	43	66	84	86	84	109	109		

### Accessories

<b>CZ-RTC6W</b>	CONEX wired remote controller (non-wireless), white
<b>CZ-RTC6WBL</b>	CONEX wired remote controller with Bluetooth®, white
<b>CZ-RTC6WBLW2</b>	CONEX wired remote controller with Wi-Fi and Bluetooth®, white
<b>CZ-RTC6</b>	CONEX wired remote controller (non-wireless), black
<b>CZ-RTC6BL</b>	CONEX wired remote controller with Bluetooth®, black
<b>CZ-RTC6BLW2</b>	CONEX wired remote controller with Wi-Fi and Bluetooth®, black
<b>CZ-RTC5B</b>	Wired remote controller with Econavi function
<b>CZ-RWS3 + CZ-RWRC3</b>	Infrared remote controller and receiver
<b>PAW-WTRAY</b>	Tray for condenser water compatible with outdoor elevation platform

### Accessories

<b>PAW-GRDBSE20</b>	Outdoor base ground support for noise and vibration absorption
<b>PAW-GRDSTD40</b>	Outdoor elevation platform 400x900x400 mm
<b>CZ-CENSC1</b>	Econavi energy saving sensor
<b>CZ-56DAF2</b>	Air outlet plenum for S-3650PF3E
<b>CZ-90DAF2</b>	Air outlet plenum for S-6071PF3E
<b>CZ-160DAF2</b>	Air outlet plenum for S-1014PF3E
<b>PAW-APF800F</b>	BION air pollutant filter for S-3650PF3E
<b>PAW-APF1000F</b>	BION air pollutant filter for S-6071PF3E
<b>PAW-APF1400F</b>	BION air pollutant filter for S-1014PF3E

### Technical focus

- 2 installation possibilities (horizontal / vertical)
- Maximum external static pressure: 150 Pa
- Selectable inlet air position (rear / bottom entry)
- Improved drain pan suitable for both horizontal / vertical installation
- Drain pump included
- nanoe™ X (Generator Mark 2: 9,6 trillion hydroxyl radicals/sec) as standard for the long duct piping case\*
- BION air pollutant filter for certain types of pollutants, such as nitrogen dioxide (NO<sub>2</sub>), nitrogen oxides (NO<sub>x</sub>) and Ozone (O<sub>3</sub>) (optional)
- Wired remote control CZ-RTC6WBL and CZ-RTC6BL allows easy system setting via Bluetooth®

\* The performance of nanoe™ X air can be expected even by 10 m long duct by Panasonic internal survey.

### 2 installation possibilities (horizontal / vertical)

Vertical installation is available. External static pressure 150 Pa, sufficient for remotely installing units away from the rooms.



### Improved drain pan design

Just one drain pan for both horizontal and vertical installations. No need to modify the unit.

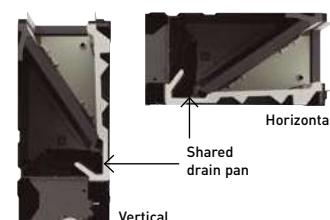

## PACi NX Jet Air Stream - R32

For light refrigeration applications.

Touch panel controller.  
PCZ-AHRX0012

				High temperature			
Kit				125	140	200	250
Indoor unit <sup>1)</sup>				P-VTVF140	P-VTVF140	P-VTVF250	P-VTVF250
Outdoor unit				U-125PZH4E5/8	U-140PZH4E5/8	U-200PZH4E8	U-250PZH4E8
Outdoor 35 °C (DB)	Indoor 15 °C (WB)	Cooling capacity	kW	14,85	14,85	23,77	23,77
		EER		2,41	2,41	3,17	3,17
		Input power	kW	6,15	6,15	7,49	7,49
	Indoor 12 °C (WB)	Cooling capacity	kW	13,56	13,56	21,70	21,70
		EER		2,25	2,25	2,95	2,95
		Input power	kW	6,03	6,03	7,34	7,34
Indoor 8 °C (WB)	Cooling capacity	kW	11,83	11,83	18,93	18,93	
	EER		2,02	2,02	2,65	2,65	
	Input power	kW	5,87	5,87	7,14	7,14	
Outdoor 30 °C (DB)	Indoor 15 °C (WB)	Cooling capacity	kW	15,94	15,94	25,51	25,51
		EER		2,54	2,54	3,33	3,33
		Input power	kW	6,28	6,28	7,65	7,65
	Indoor 12 °C (WB)	Cooling capacity	kW	14,49	14,49	23,19	23,19
		EER		2,35	2,35	3,09	3,09
		Input power	kW	6,16	6,16	7,50	7,50
Indoor 8 °C (WB)	Cooling capacity	kW	12,46	12,46	19,94	19,94	
	EER		2,08	2,08	2,73	2,73	
	Input power	kW	6,00	6,00	7,30	7,30	
Indoor unit		Dimension (HxWxD)	mm	802 x 1105 x 893	802 x 1105 x 893	1026 x 1458 x 953	1026 x 1458 x 953
		Net weight	kg	88	88	130	130
Outdoor unit		Dimension (HxWxD)	mm	996 x 980 x 370	996 x 980 x 370	996 x 1140 x 460	996 x 1140 x 460
		Net weight	kg	86	86	109	109

1) The CONEX controller CZ-RTC6 (-BL/-BLW2) is not required.

Optional configurations*		Front panel type	Air flow (m³/h)
<b>P-VTVF140NC5-PE</b>	Jet Air Stream Standard	Manual nozzles	2500
<b>P-VTVF250NC5-PE</b>	Jet Air Stream Standard	Manual nozzles	5000
<b>P-VTVF140PC5-PE</b>	Jet Air Stream Ducted	Ducted front panel	2500
<b>P-VTVF250PC5-PE</b>	Jet Air Stream Ducted	Ducted front panel	5000

\* The product technical data is the same as Jet Air Stream Smart.

Accessories	
<b>CZ-RTC6W</b>	CONEX wired remote controller (non-wireless), white
<b>CZ-RTC6WBL</b>	CONEX wired remote controller with Bluetooth®, white
<b>CZ-RTC6WBLW2</b>	CONEX wired remote controller with Wi-Fi and Bluetooth®, white
<b>CZ-RTC6</b>	CONEX wired remote controller (non-wireless), black
<b>CZ-RTC6BL</b>	CONEX wired remote controller with Bluetooth®, black
<b>CZ-RTC6BLW2</b>	CONEX wired remote controller with Wi-Fi and Bluetooth®, black
<b>PCZ-AHRX0012</b>	Touch panel controller with Modbus integration and group control up to 8 units







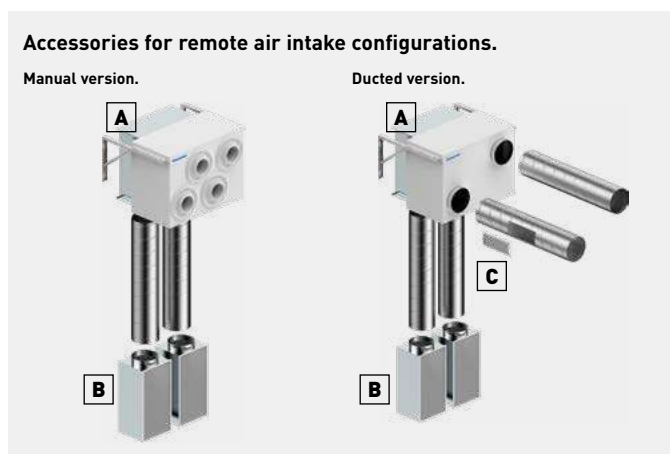







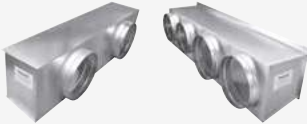











## Technical focus

- Energy-saving solution for year-round heating and cooling in large and high spaces
- High air volume up to 5000 m³/h and long maximum air throw distance of 30 m
- Optimal comfort with Smart Jet - self-directing nozzles

Accessories	
<b>PCZ-AHRP0681</b>	Recessed mounting box for controller
<b>A PCZ-AHRX0051</b>	Ducted air intake plenum (1x DN 355 mm) for VTVF140N and VTVF140P
<b>A PCZ-AHRX0052</b>	Ducted air intake plenum (2x DN 355 mm) for VTVF250N and VTVF250P
<b>B PCZ-AHRX0061</b>	Ground air intake module (VTVF250 requires two of them)
<b>C PCZ-AHRX0071</b>	Air supply grille for ducts

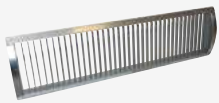

# Accessories and control - PACi NX

Panels			IAQ filter for adaptive ducted unit			
						
<b>Standard panel for 4 way 90x90 cassette, white (RAL9003).</b>	<b>Econavi panel for 4 way 90x90 cassette, white (RAL9003).</b>	<b>NEW Standard panel for 4 way 90x90 cassette, graphite black (RAL9011).</b>	<b>BION air pollutant filter for S-3650PF3E.</b>	<b>BION air pollutant filter for S-6071PF3E.</b>	<b>BION air pollutant filter for S-1014PF3E.</b>	
----- CZ-KPU3	----- CZ-KPU3A	----- CZ-KPU3B	----- PAW-APF800F	----- PAW-APF1000F	----- PAW-APF1400F	
Plenums			Special outdoor supports			
						
<b>Air outlet plenum for S-3650PF3E.</b>	<b>Air outlet plenum for S-6071PF3E.</b>	<b>Air outlet plenum for S-1014PF3E.</b>	<b>Tray for condenser water compatible with outdoor elevation platform.</b>	<b>Outdoor elevation platform.</b> Dimension (HxWxD): 400x900x400 mm	<b>Outdoor base ground support for noise and vibration absorption.</b> Dimension (HxWxD): 600x95x130 mm Safe working load: 500 kg	
----- CZ-56DAF2	----- CZ-90DAF2	----- CZ-160DAF2	----- PAW-WTRAY	----- PAW-GRDSTD40	----- PAW-GRDBSE20	
Individual controls						
						
<b>CONEX wired remote controller (non-wireless), white.</b>	<b>CONEX wired remote controller with Bluetooth®, white.</b>	<b>CONEX wired remote controller with Wi-Fi and Bluetooth®, white.</b>	<b>CONEX wired remote controller (non-wireless), black.</b>	<b>CONEX wired remote controller with Bluetooth®, black.</b>	<b>CONEX wired remote controller with Wi-Fi and Bluetooth®, black.</b>	
----- CZ-RTC6W	----- CZ-RTC6WBL	----- CZ-RTC6WBLW2	----- CZ-RTC6	----- CZ-RTC6BL	----- CZ-RTC6BLW2	
						
<b>Design Wired remote controller with Econavi function.</b>	<b>Infrared remote controller for wall-mounted.</b>	<b>Infrared remote controller and receiver for 4 way 90x90 cassette.</b>	<b>Infrared remote controller and receiver for ceiling.</b>	<b>Infrared remote controller and receiver for all indoor units.</b>		
----- CZ-RTC5B	----- CZ-RWS3	----- CZ-RWS3 + CZ-RWRU3	----- CZ-RWS3 + CZ-RWRT3	----- CZ-RWS3 + CZ-RWRC3		
Accessories PCB			Sensors			
						
<b>PCB for server room application, control up to 4 indoor unit groups, redundancy, backup, etc.</b>			<b>Econavi energy saving sensor.</b>			<b>Fresh air-intake kit.</b>
----- PAW-PACR4			----- CZ-CENS1			----- CZ-FDU3+CZ-ATU2
Accessories for Jet Air Stream						
						
<b>Touch panel controller with Modbus integration and group control up to 8 units.</b>	<b>Recessed mounting box for controller.</b>	<b>Ducted air intake plenum (1 x DN 355 mm) for VTVF140N and VTVF140P.</b>	<b>Ducted air intake plenum (2 x DN 355 mm) for VTVF250N and VTVF250P.</b>	<b>Ground air intake module (VTVF250 requires two of them).</b>	<b>Air supply grille for ducts.</b>	
----- PCZ-AHRX0012	----- PCZ-AHRP0681	----- PCZ-AHRX0051	----- PCZ-AHRX0052	----- PCZ-AHRX0061	----- PCZ-AHRX0071	

# Dimensions

## Aquarea

All in One H Series	→ 633
All in One / with Electrical Anode K Series (185 L)	→ 633
All in One 2 zones K Series (185 L)	→ 634
Hydraulic All in One / with Electrical Anode L Series (185 L)	→ 634
Hydraulic All in One 2 zones L Series (185 L)	→ 635
Hydraulic All in One / with Electrical Anode M Series (185 L)	→ 635
Hydraulic All in One / with Electrical Anode M Series (260 L)	→ 636
Bi-bloc H Series	→ 636
Bi-bloc K Series	→ 637
Hydraulic Bi-bloc L Series	→ 637
Hydraulic Bi-bloc M Series	→ 638
EcoFlex	→ 638
Outdoor units	→ 640
Aquarea Air Smart fan coils	→ 644
Aquarea Loop	→ 653
Buffer tanks	→ 653
Enamelled tanks	→ 654
Stainless steel tanks	→ 656
Heat recovery ventilation unit	→ 656

## Domestic

Heatcharge VZ	→ 657
Etherea	→ 658
TZ super-compact	→ 660
BZ super-compact	→ 662
UZ super-compact	→ 663
Floor console	→ 664
Low static pressure hide-away	→ 665
4 Way 60x60 cassette	→ 666
Outdoor units Multi systems	→ 667
RAC Solo	→ 670

## Commercial

Wall-mounted Professional	→ 671
Wall-mounted	→ 673
4 way 60x60 cassette	→ 674
4 way 90x90 cassette	→ 675
Ceiling	→ 676
Adaptive ducted unit	→ 679
Big PACi NX	→ 680
Jet Air Stream	→ 681
Outdoor units	→ 682
PACi Water Heat Exchanger	→ 684

## VRF Systems

Mini ECOi LZ2 Series	→ 685
Mini ECOi LE2 / LE1 Series	→ 686
2-Pipe ECOi EX MZ1 Series	→ 687
2-Pipe ECOi EX ME2 Series	→ 687
3-Pipe ECOi EX MF3 Series	→ 688
2-Pipe ECO G GE3 Series	→ 689
3-Pipe ECO G GF3 Series	→ 690
3-Pipe Control Box Kit	→ 691
2-Pipe Hybrid GHP / EHP	→ 691
Water Heat Exchanger	→ 693
U2 type 4 way 90x90 cassette	→ 694
Y3 type 4 way 60x60 cassette	→ 695
L1 type 2 way cassette	→ 696
D1 type 1 way cassette	→ 696
F3 type variable static pressure adaptive duct	→ 697
M2 type slim variable static pressure hide-away concealed duct	→ 698
E2 type high static pressure hide-away	→ 699
K3 type wall-mounted	→ 700
T2 type ceiling	→ 701
G1 type floor console	→ 702
P1 type floor-standing	→ 702
R1 type concealed floor-standing	→ 703
Hydrokit for ECOi, water at 45 °C	→ 703

## Ventilation

AHU connection kit for PACi, ECOi and ECO G	→ 704
Advanced energy recovery ventilation - ZY Series	→ 704
ERV with DX coil - HRPT Series	→ 705
Electric air curtain	→ 707
Air curtain with DX coil	→ 708
E2 type high static pressure hide-away	→ 708
Ceiling mounted air-e nanoe X Generator	→ 709
Heat recovery ventilation unit	→ 709

## Connectivity

VRF Smart Connectivity+	→ 710
Commercial Wi-Fi Adaptor	→ 711
CONEX wired remote controller	→ 711
Design wired remote controller	→ 712
Econavi sensor	→ 712
Remote sensor	→ 712
Intelligent controller (touch screen/web server)	→ 712
Infrared remote controller	→ 712
System controller with weekly timer	→ 713
Local adaptor for ON / OFF control	→ 713
Communication adaptor	→ 713
Central ON / OFF controller	→ 713
Mini Seri-Para I/O Unit 0 -10 V	→ 713

## Refrigeration

CR Series 4,0 kW	→ 714
CR Series 7,5 and 8,0 kW	→ 714
CR Series 15,0 and 16,0 kW	→ 715
CR Series 29,0 kW	→ 715



Aquarea All in One H Series.

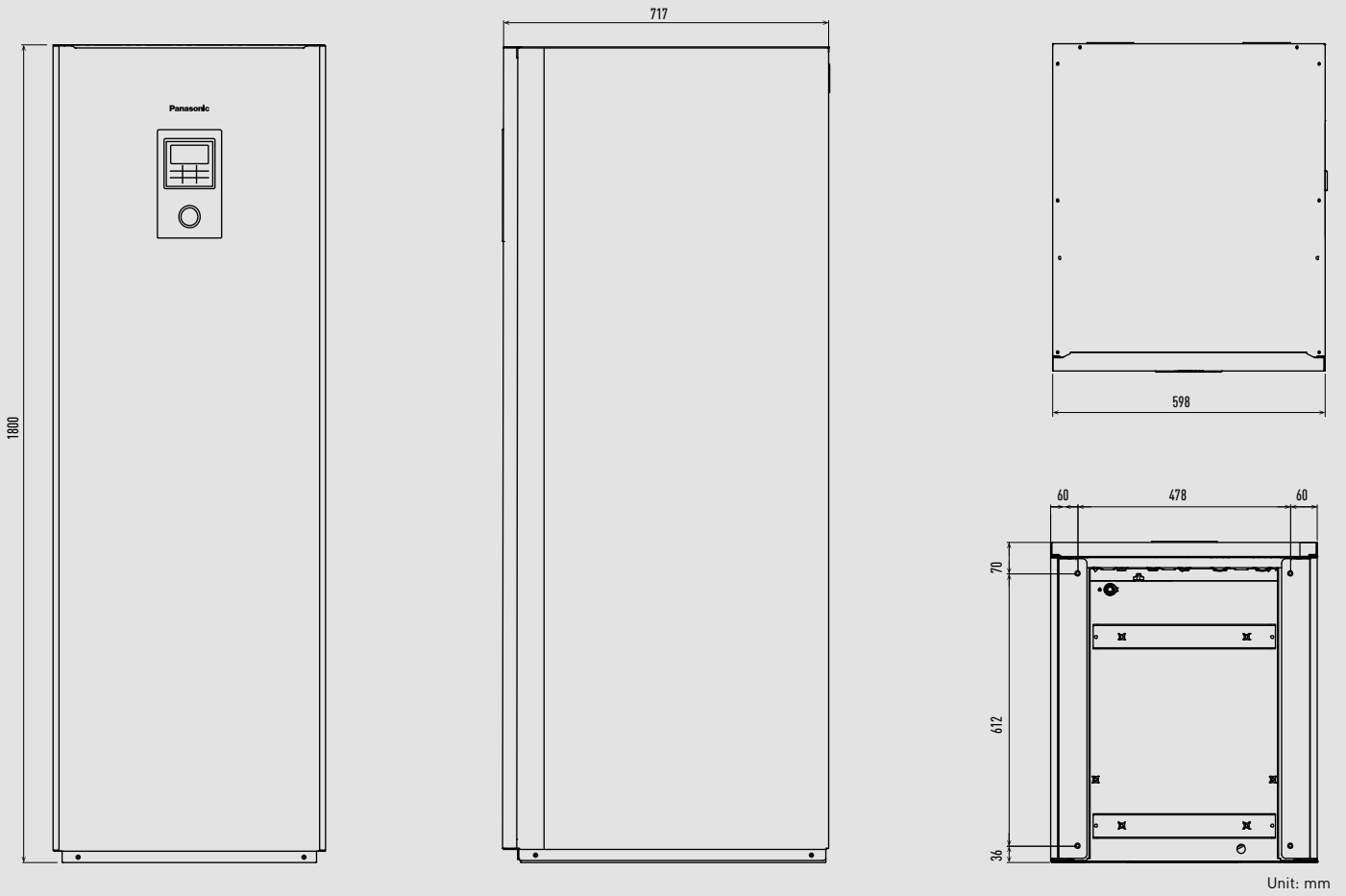

Aquarea All in One / with Electrical Anode K Series (185 L).

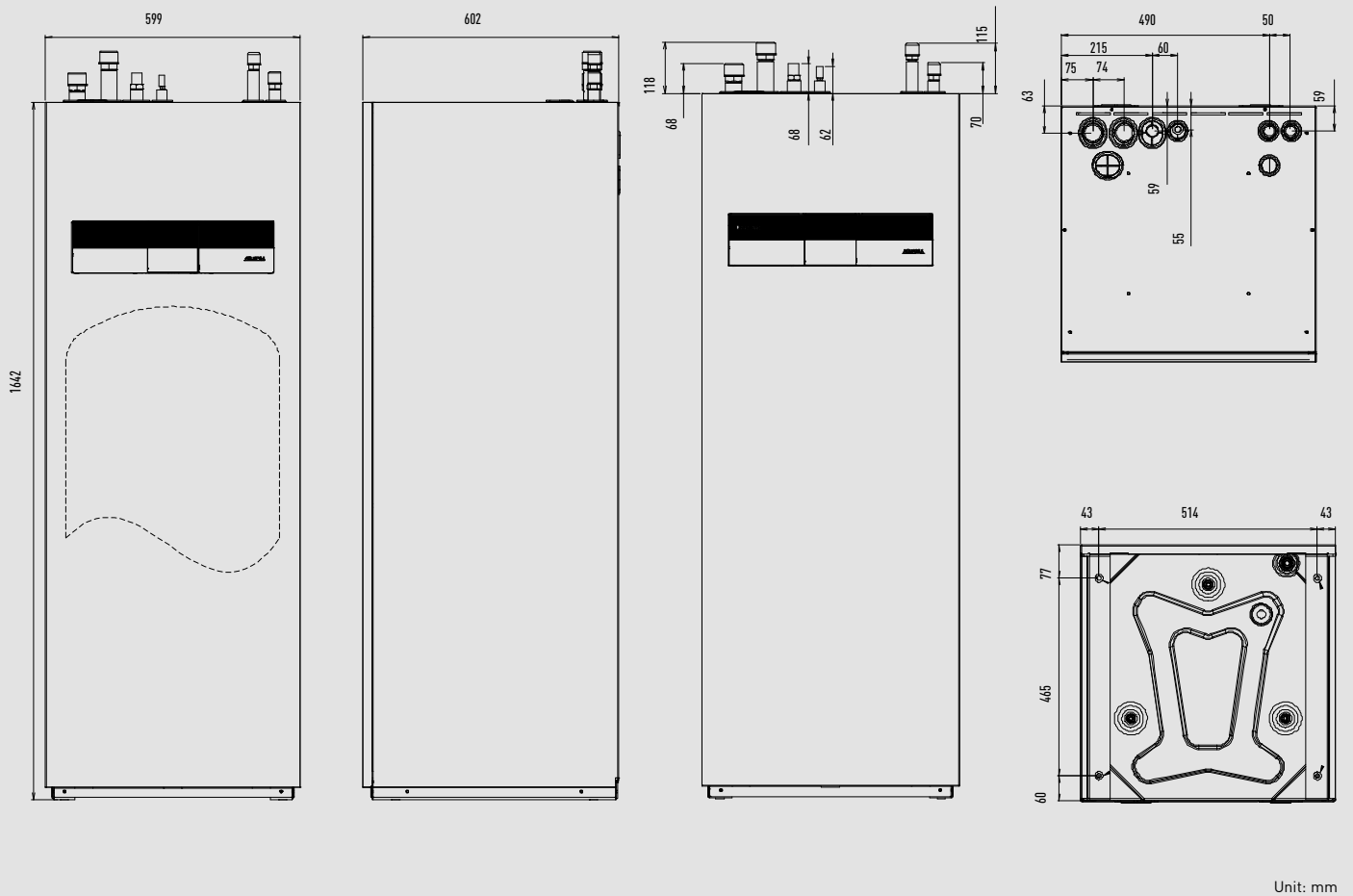

Aquarea All in One 2 zones K Series (185 L).

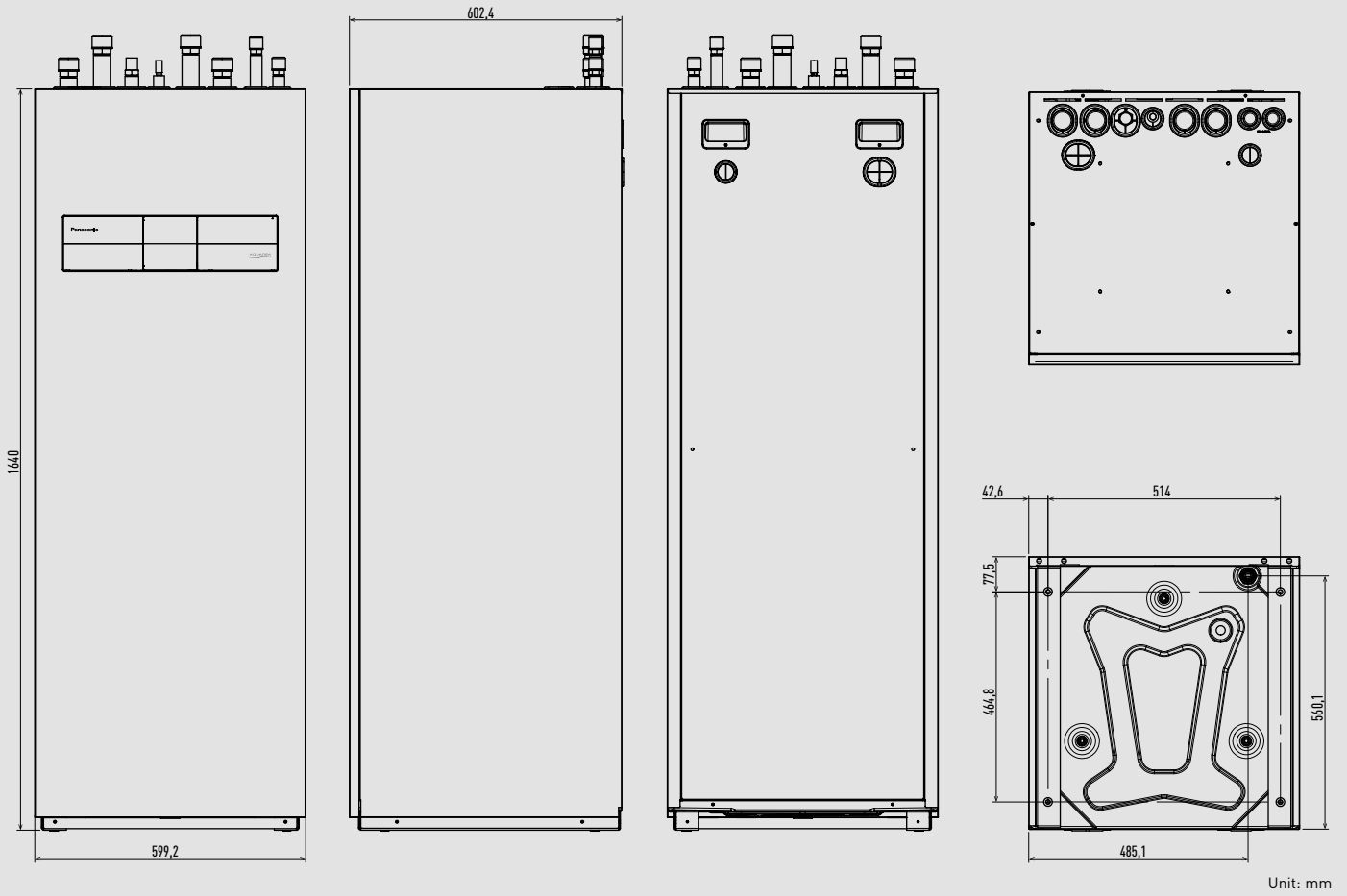

Aquarea Hydraulic All in One / with Electrical Anode L Series (185 L).

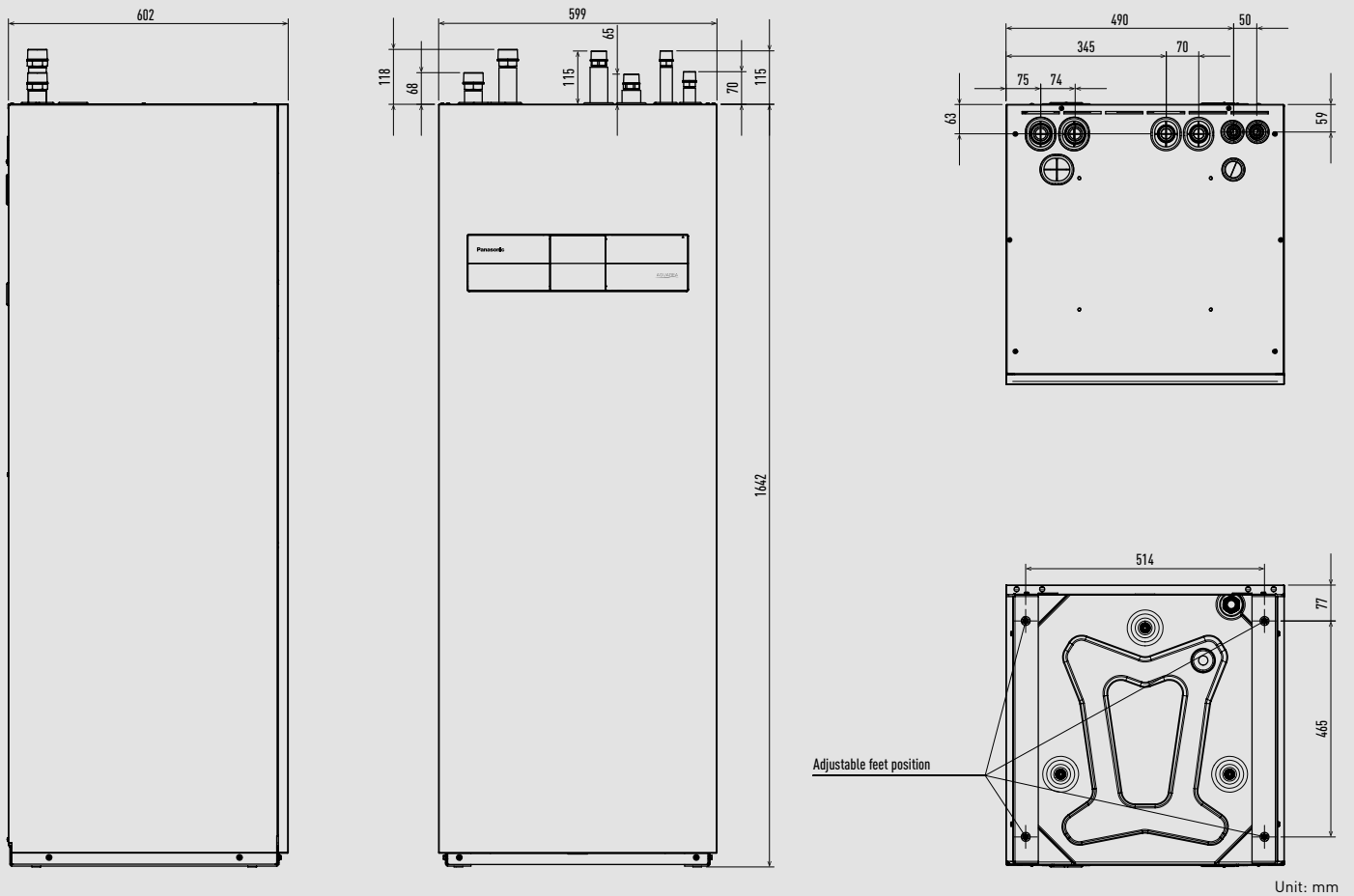



Aquarea Hydraulic All in One 2 zones L Series (185 L).

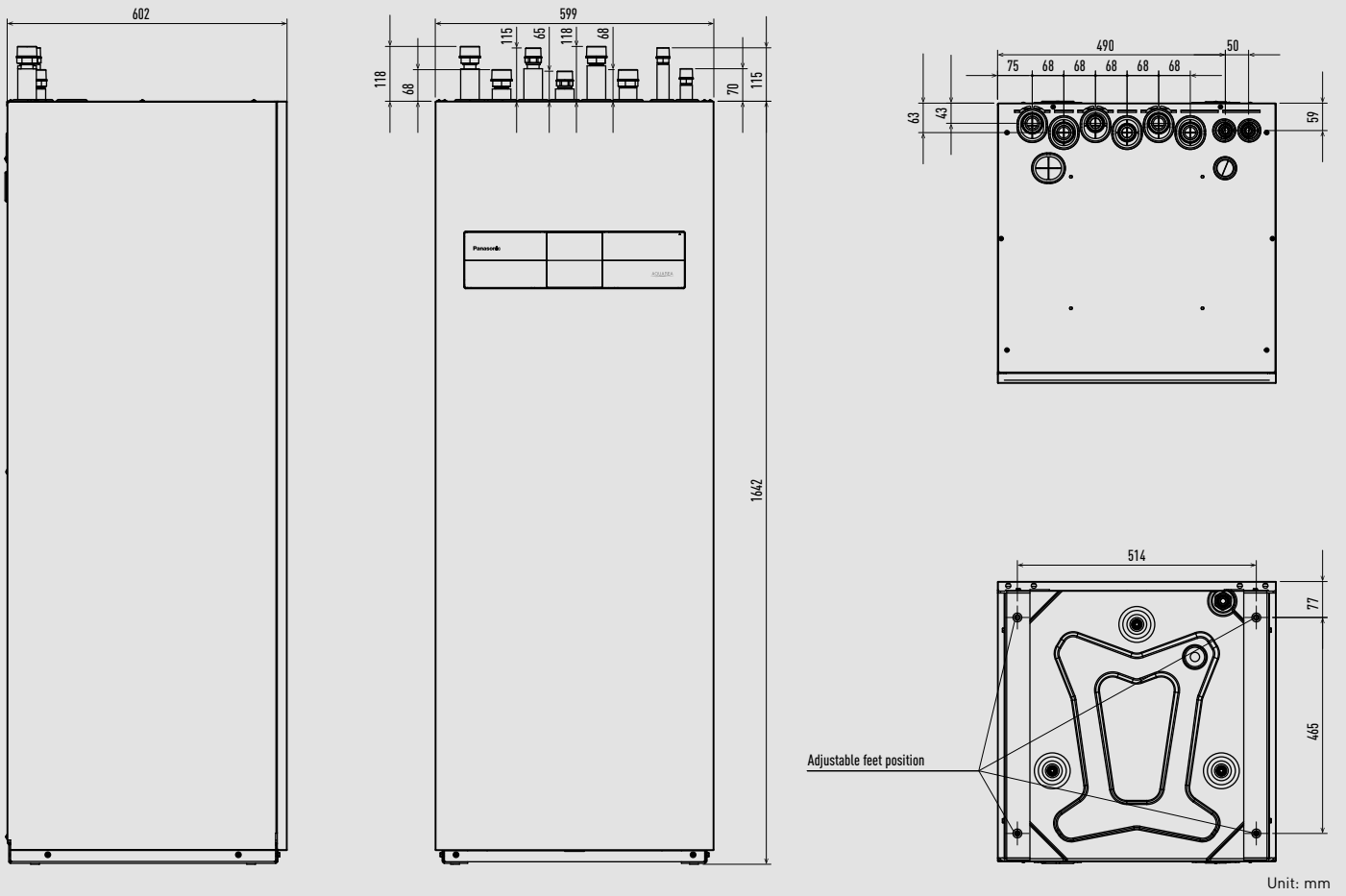

Aquarea Hydraulic All in One / with Electrical Anode M Series (185 L).

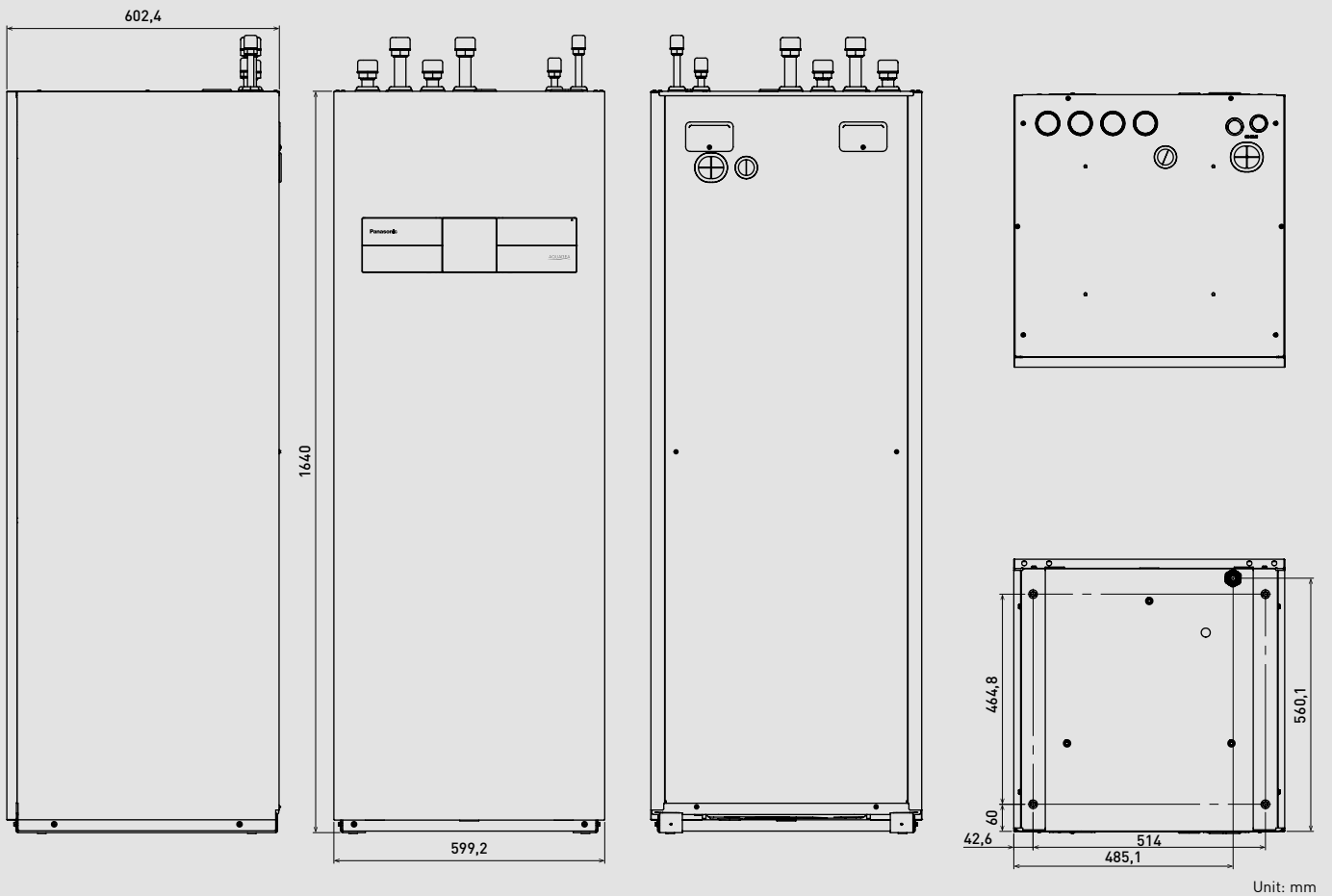

Aquarea Hydraulic All in One / with Electrical Anode M Series (260 L).

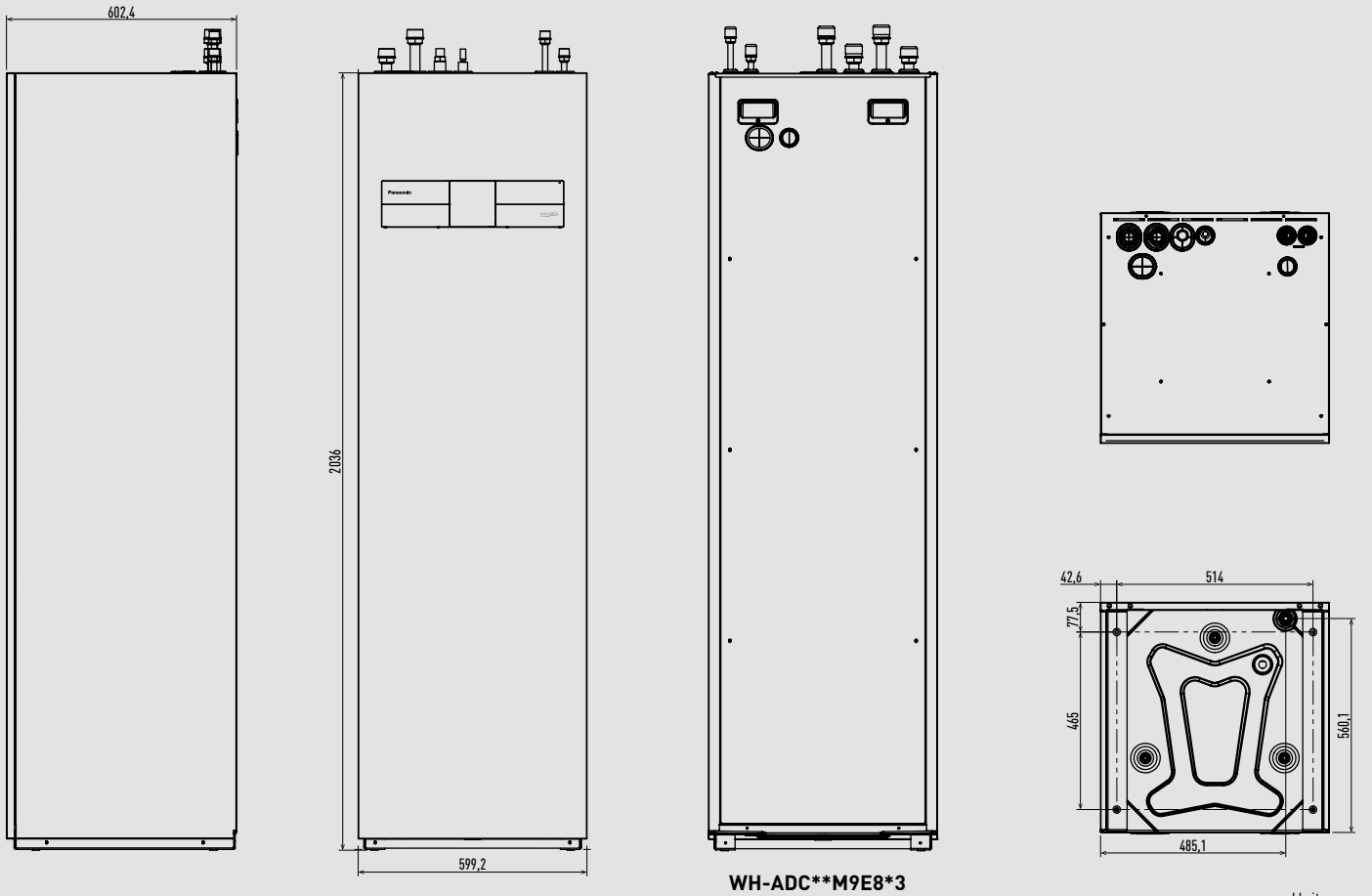

Unit: mm

Aquarea Bi-bloc H Series.

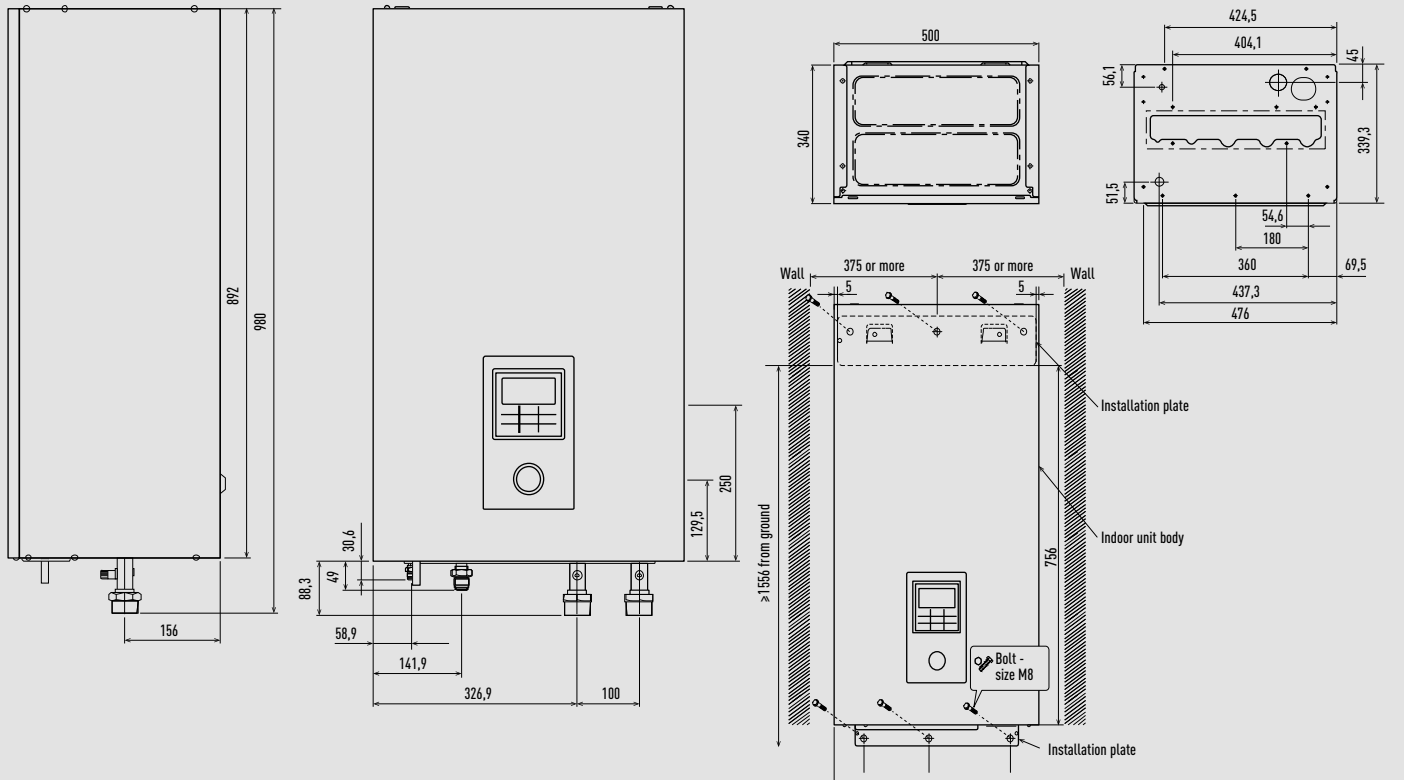

Unit: mm

Aquarea Bi-bloc K Series.

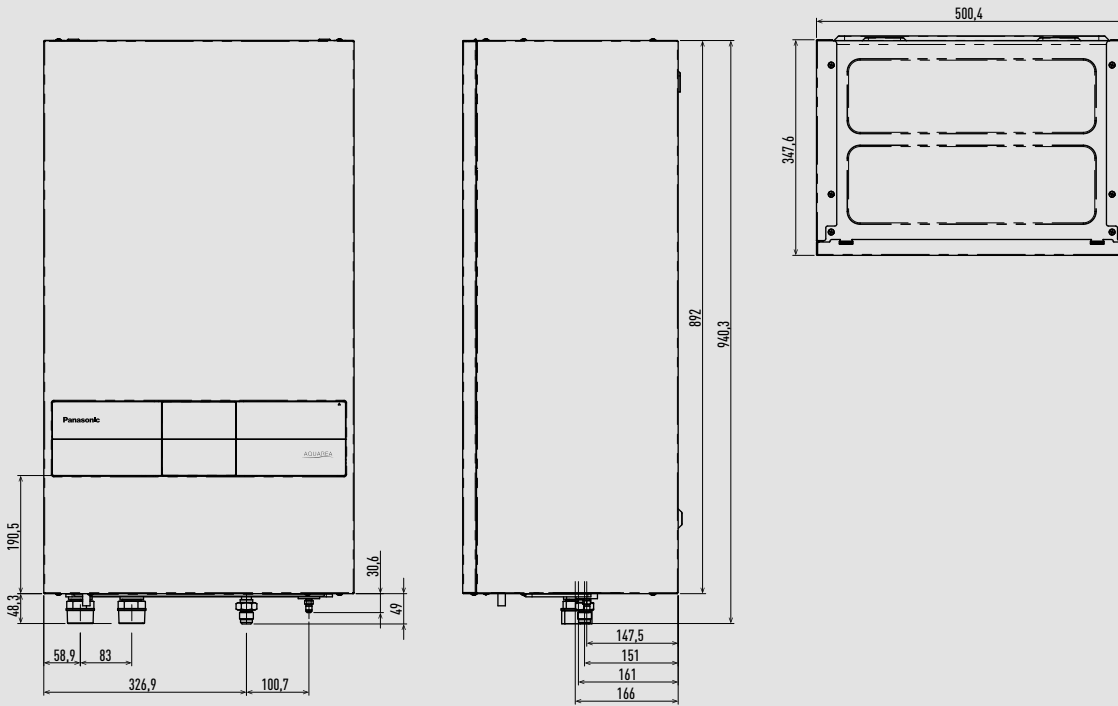

Unit: mm

Aquarea Hydraulic Bi-bloc L Series.

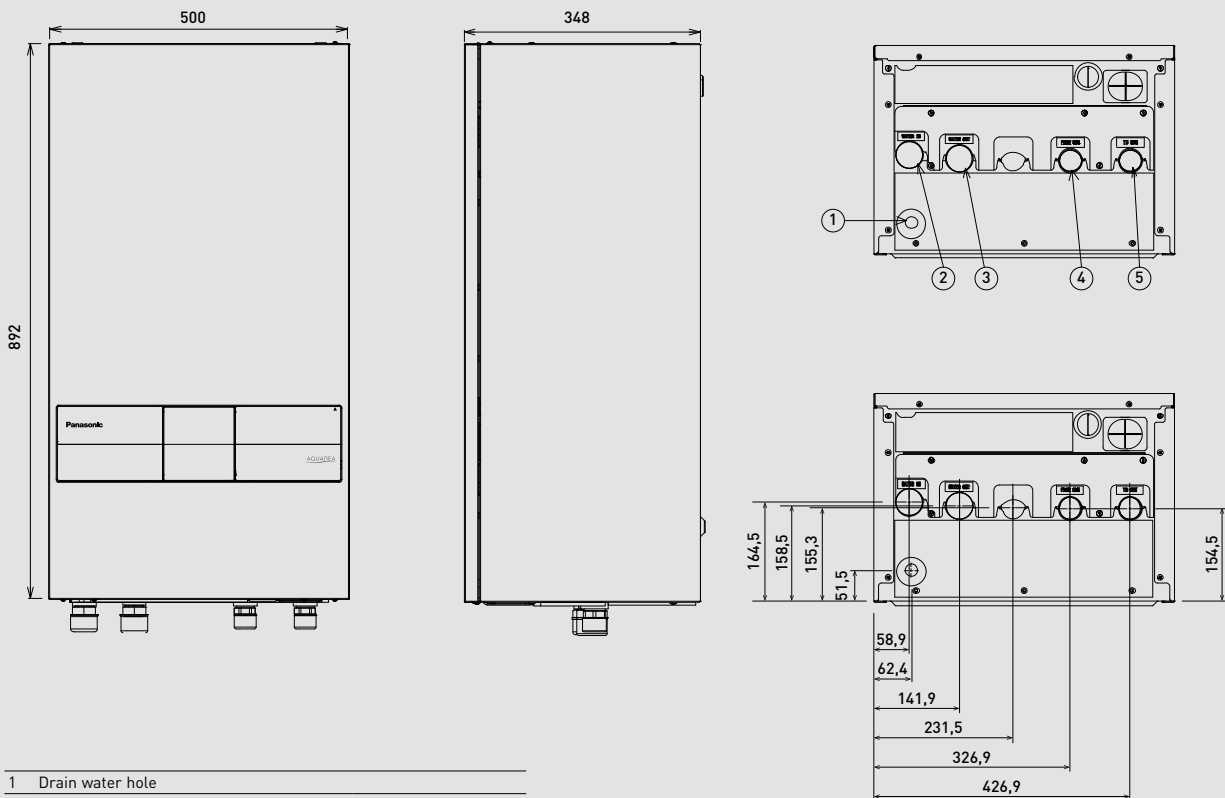

1	Drain water hole	
2	Water inlet	R 1 1/4"
3	Water outlet	R 1 1/4"
4	Water inlet (from outdoor unit)	R 1"
5	Water outlet (to outdoor unit)	R 1"

Unit: mm

Aquarea Hydraulic Bi-bloc M Series.

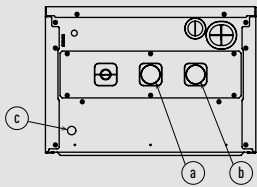
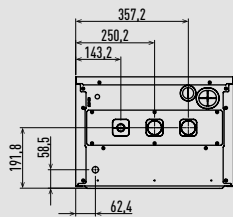
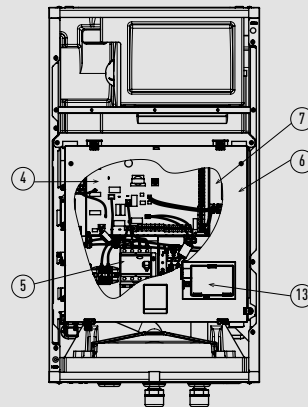
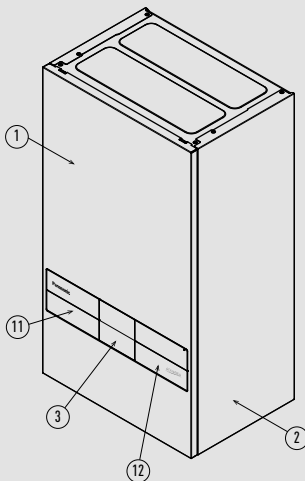
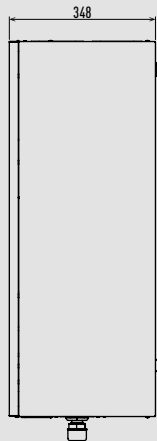
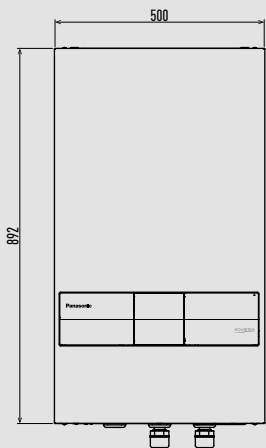

a	Water inlet	R 1 1/4
b	Water outlet	R 1 1/4
c	Drain water hole	

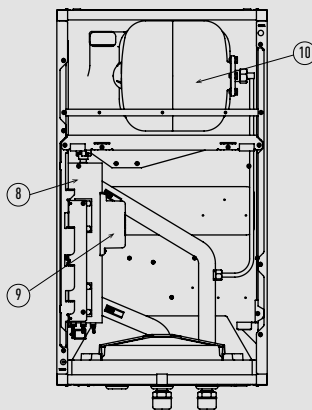

- 1 Cabinet front plate
- 2 Cabinet side plate
- 3 Remote controller
- 4 PCB
- 5 Three phase RCCB/ELCB
- 6 Control board cover
- 7 Control board
- 8 Backup heater
- 9 Overload protector
- 10 Expansion vessel
- 11 Left decoration panel
- 12 Right decoration panel
- 13 Network adaptor holder

Unit: mm

Aquarea EcoFlex tank unit.

Front view

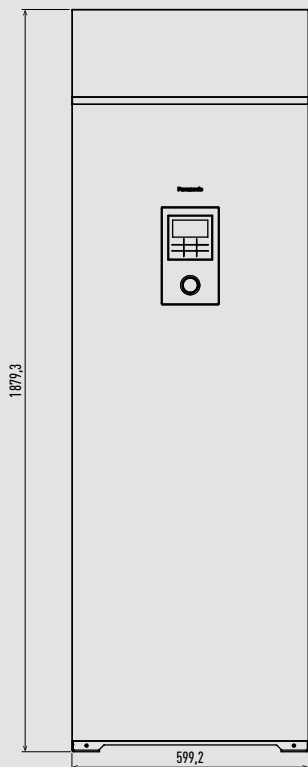

Side view

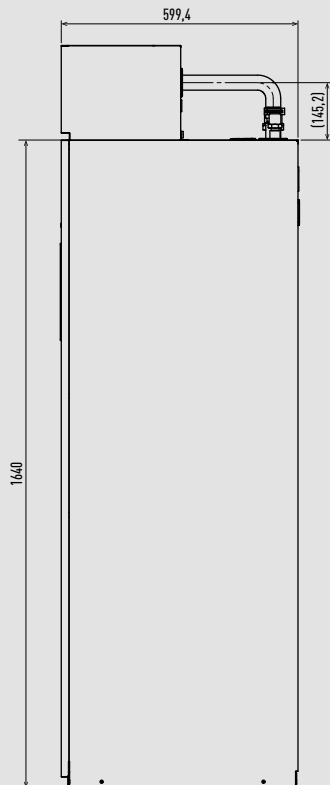

Rear view

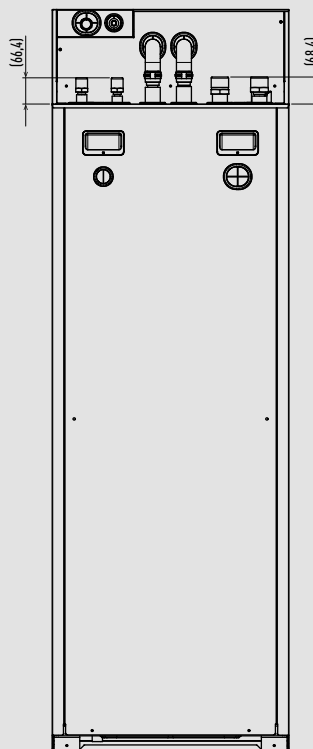

Bottom view

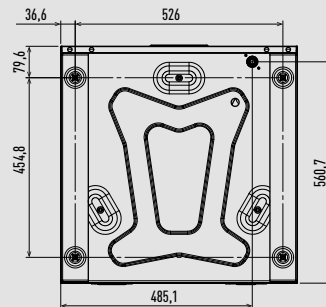

Top view

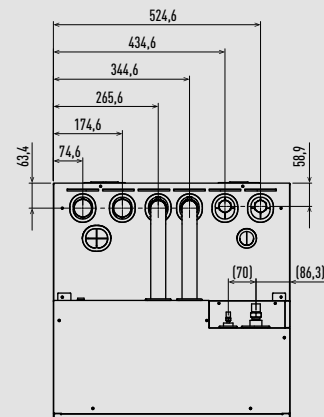

Unit: mm

Aquarea EcoFlex ducted unit.

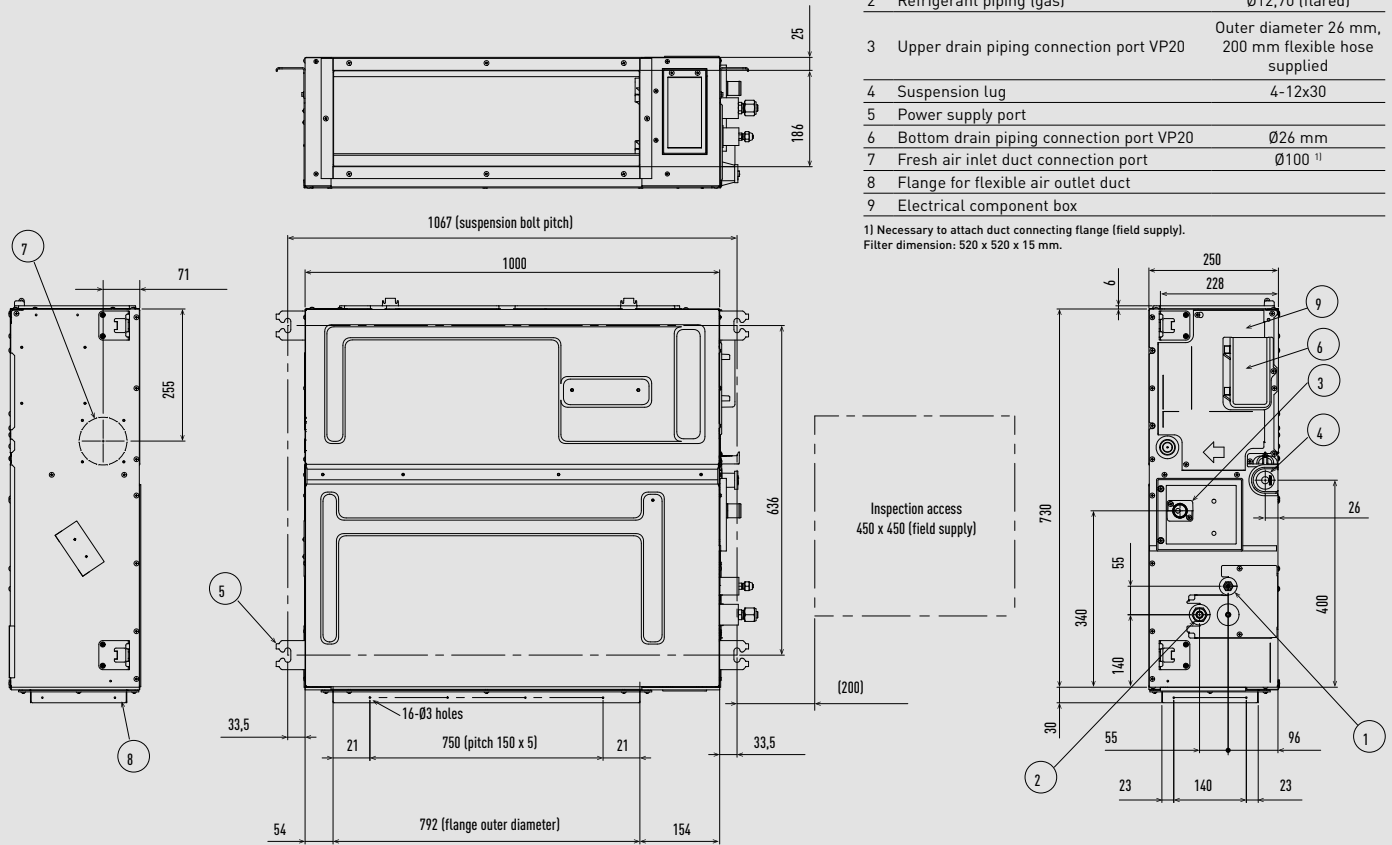

Unit: mm

Aquarea EcoFlex outdoor unit.

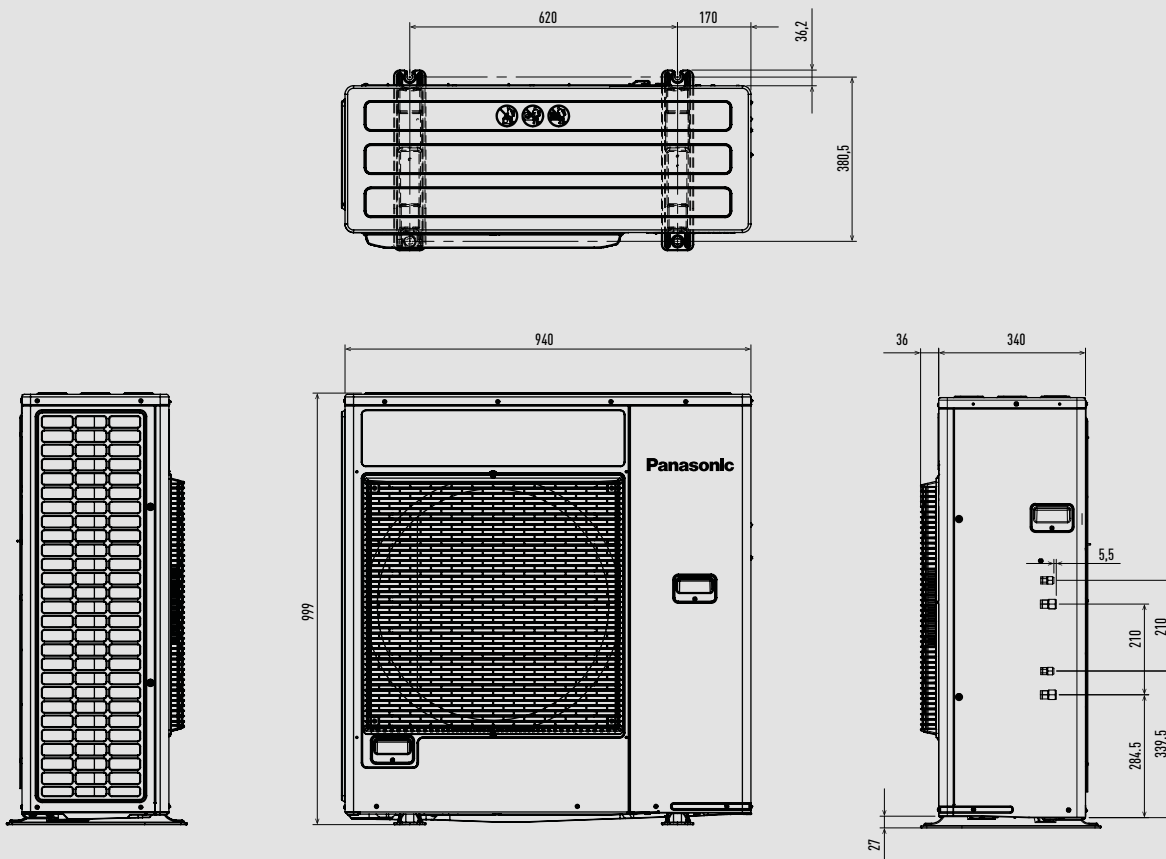

Unit: mm

Aquarea High Performance outdoor unit 3 kW K Series.

Space necessary for installation

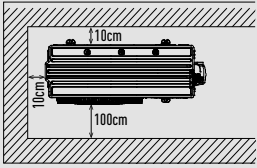

Anchor bolt pitch 355 x 260

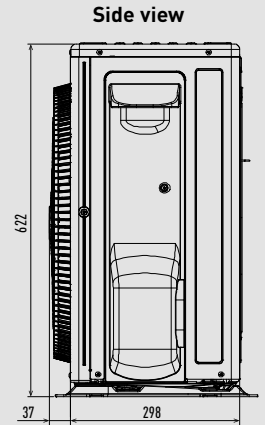
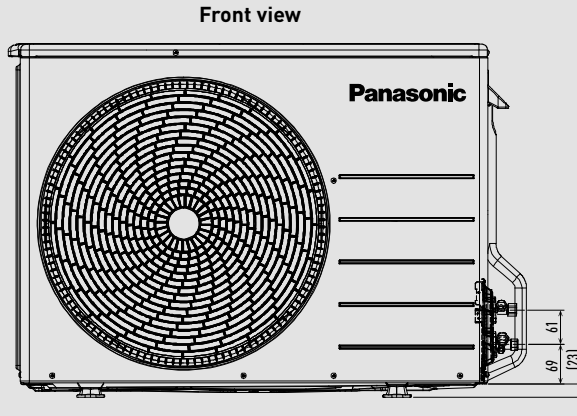
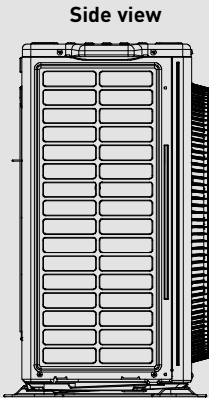
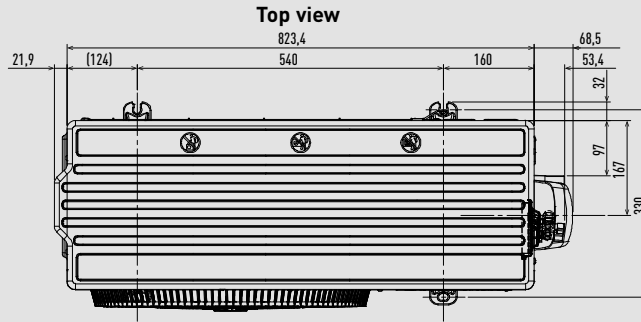

Unit: mm

Aquarea High Performance outdoor units from 5 to 9 kW K Series.

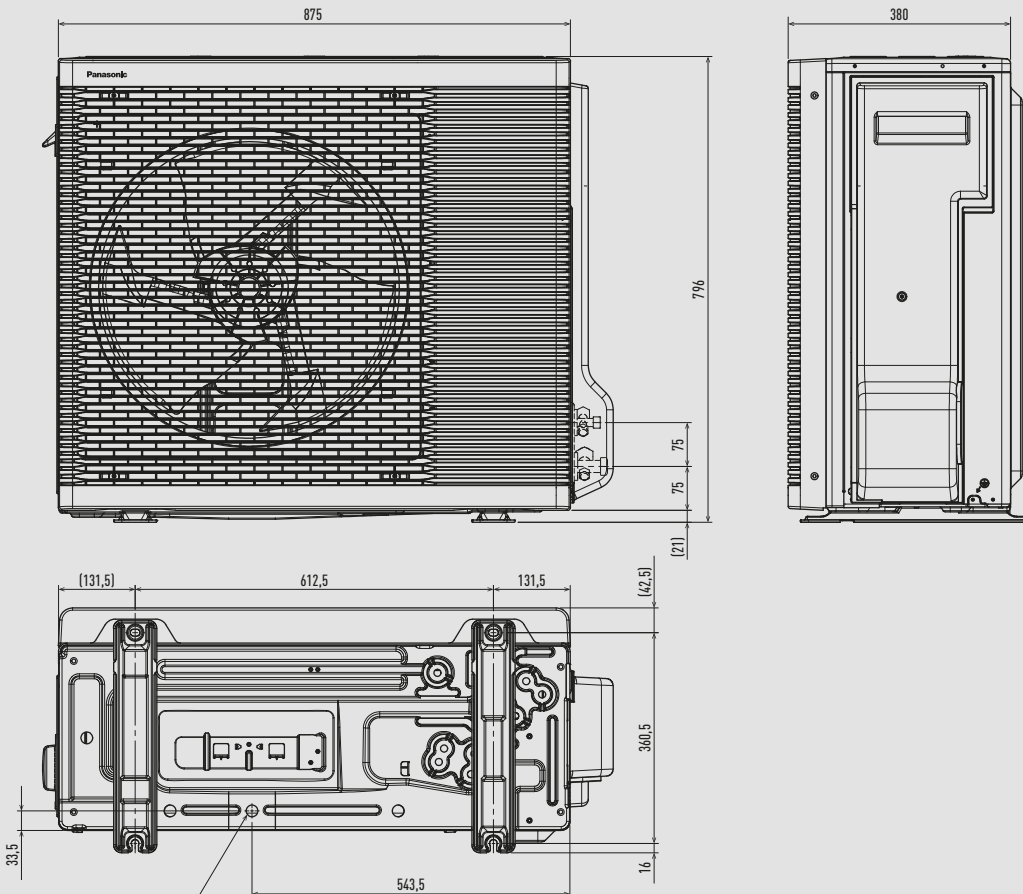

Unit: mm



Aquarea High Performance outdoor units from 12 to 16 kW single phase and 9 to 16 kW three phase K Series.  
 Aquarea T-CAP outdoor units K Series.

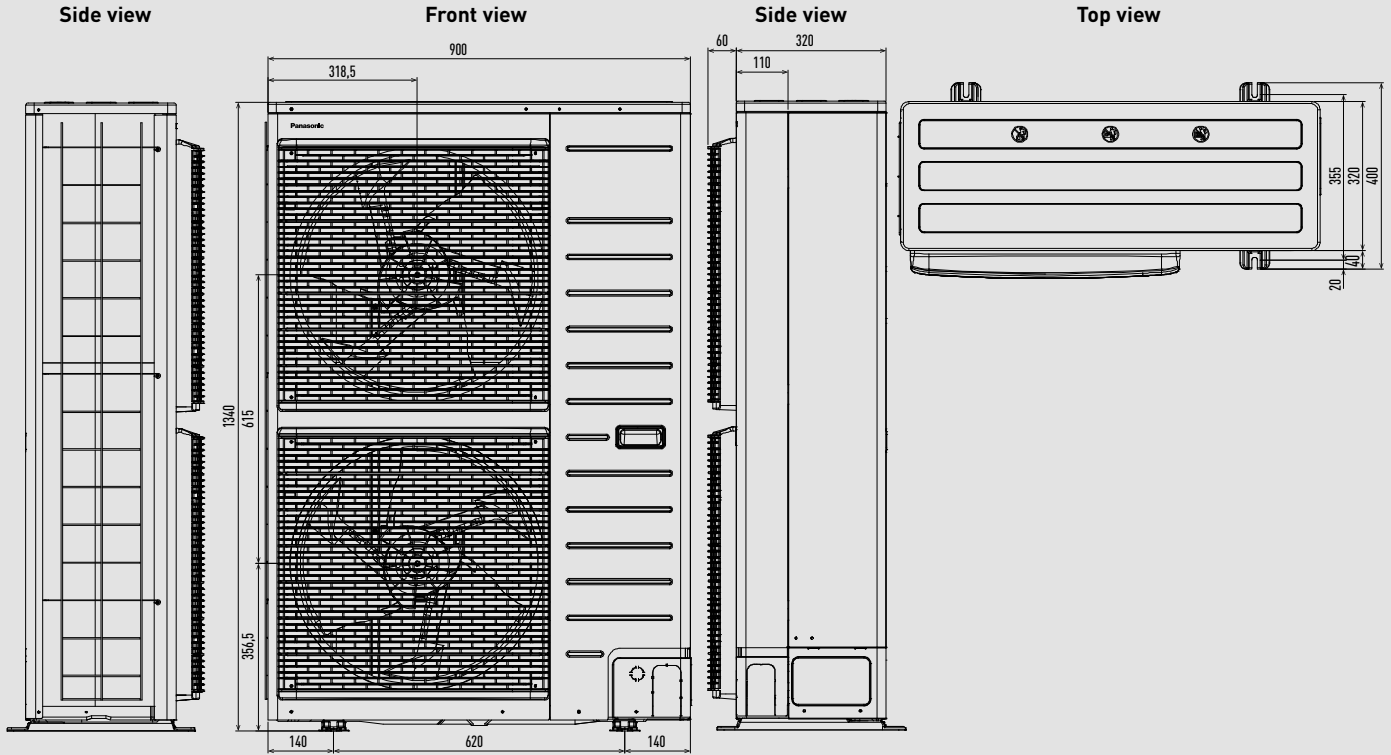

Unit: mm

Aquarea High Performance Hydraulic outdoor units from 5 to 9 kW L Series.

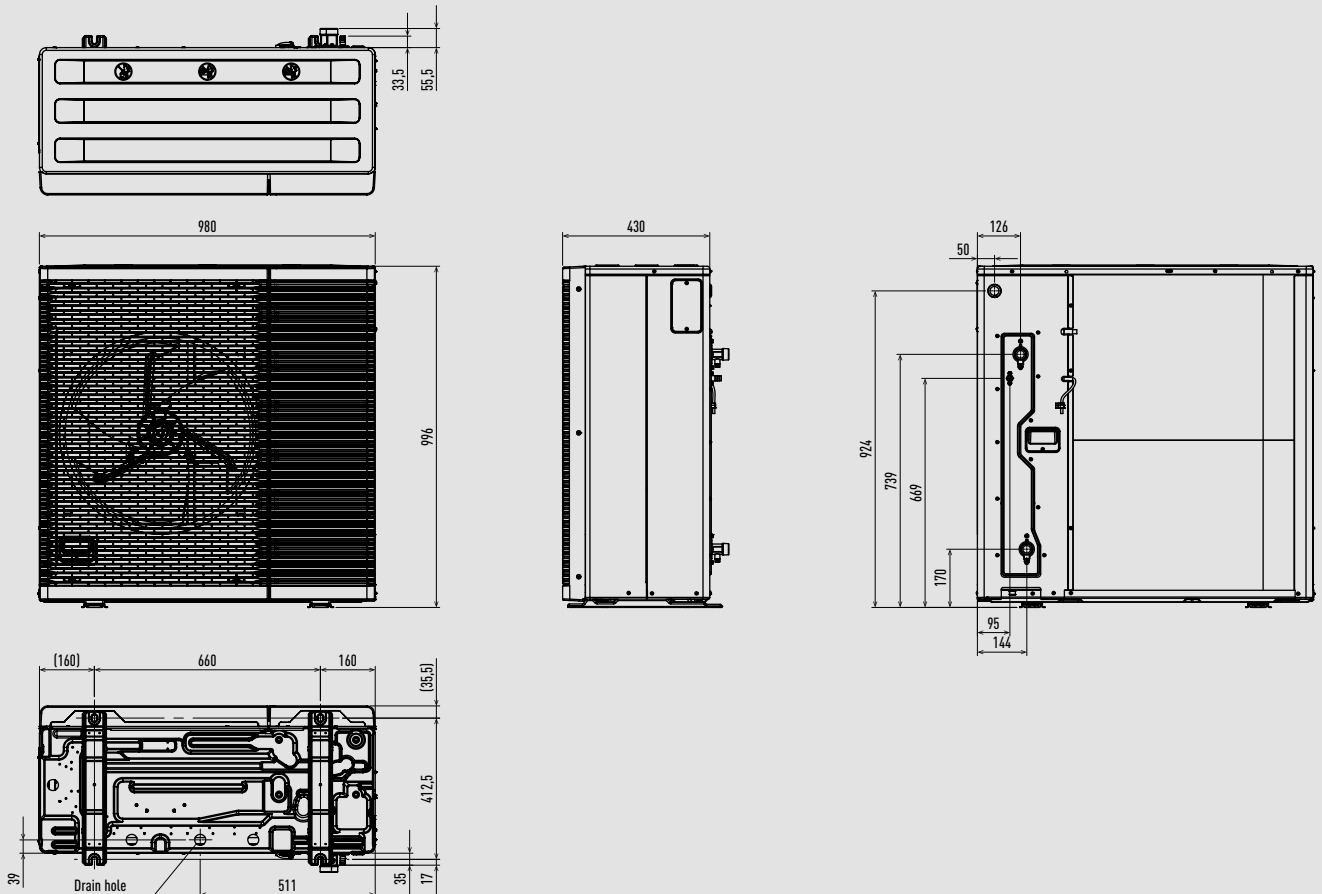

Unit: mm

Aquarea T-CAP Hydraulic M Series outdoor units from 9 to 16 kW.

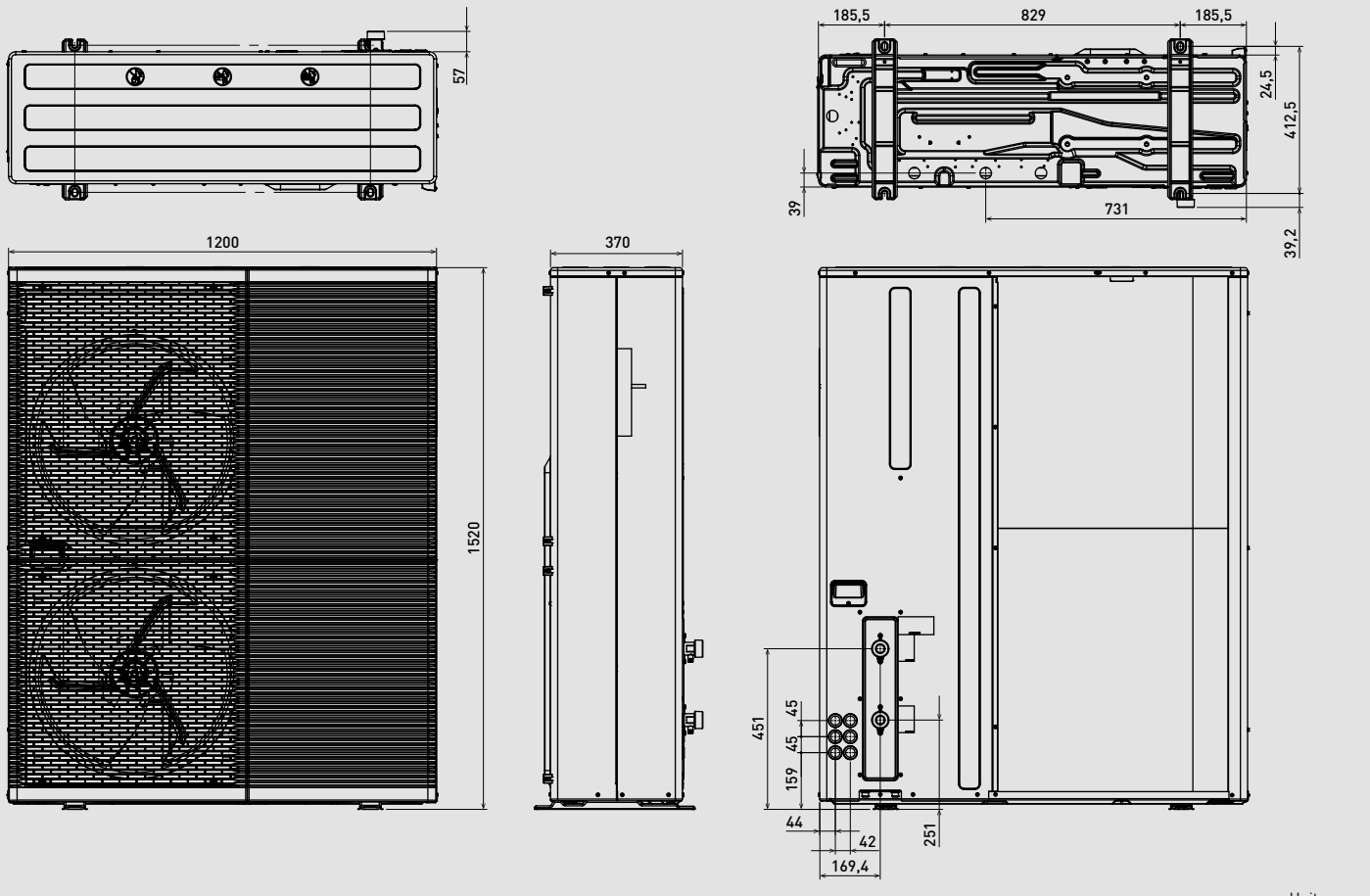

Unit: mm

Aquarea T-CAP outdoor units from 20 to 30 kW M Series.

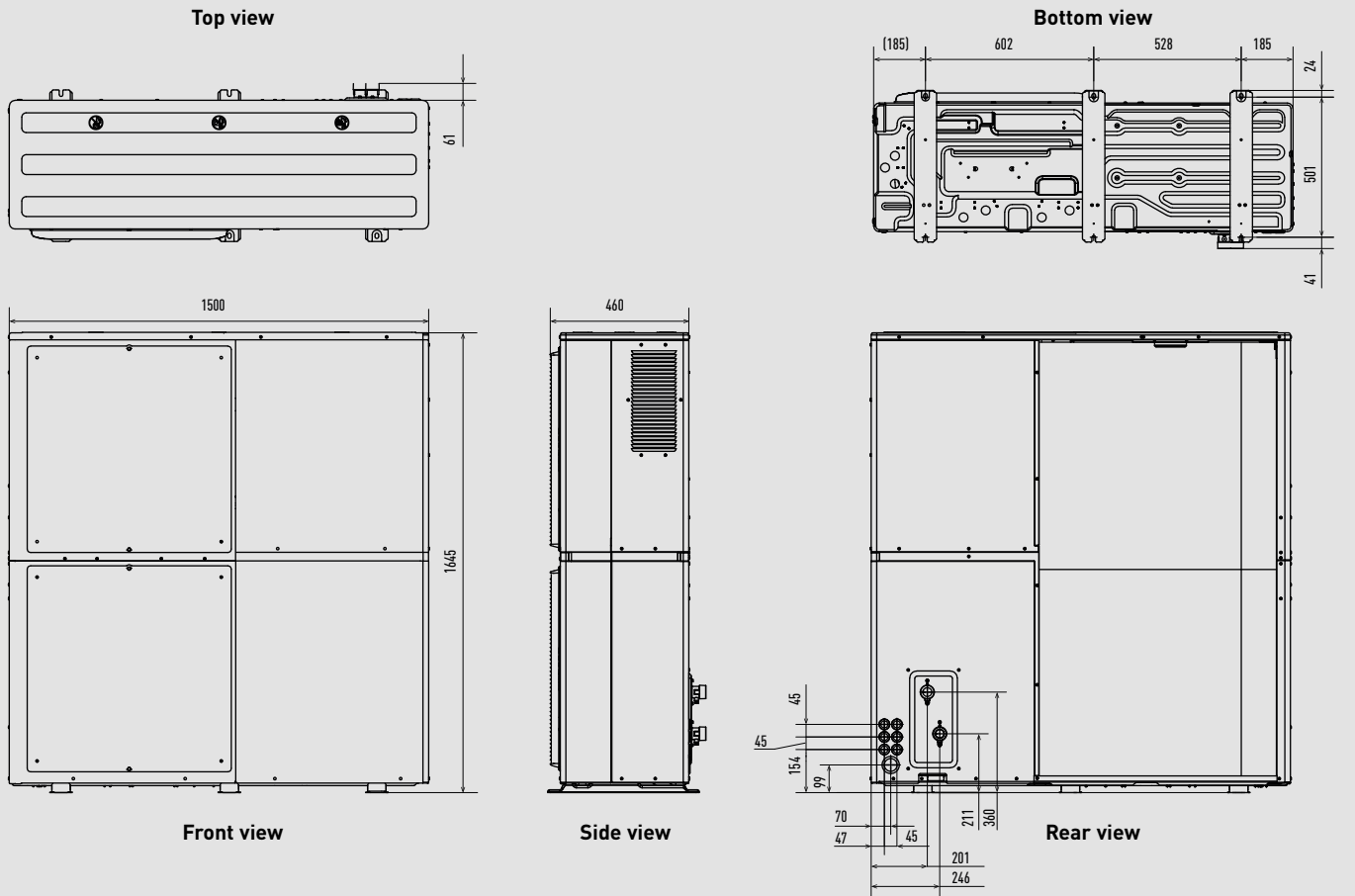

Unit: mm

Aquarea High Performance Mono-bloc outdoor units from 5 to 9 kW.

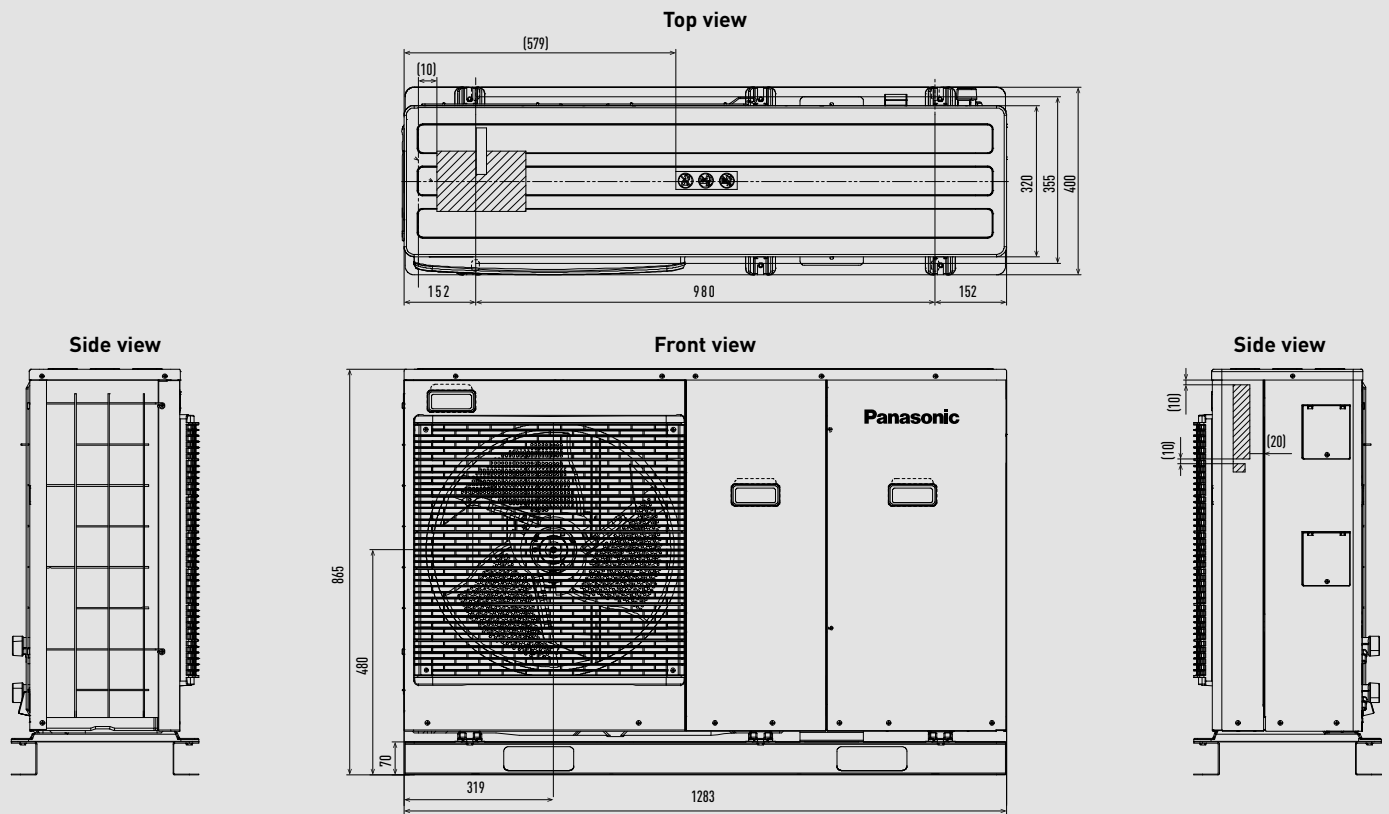

Unit: mm

Aquarea T-CAP Mono-bloc outdoor units.  
 Aquarea T-CAP Super Quiet outdoor units.

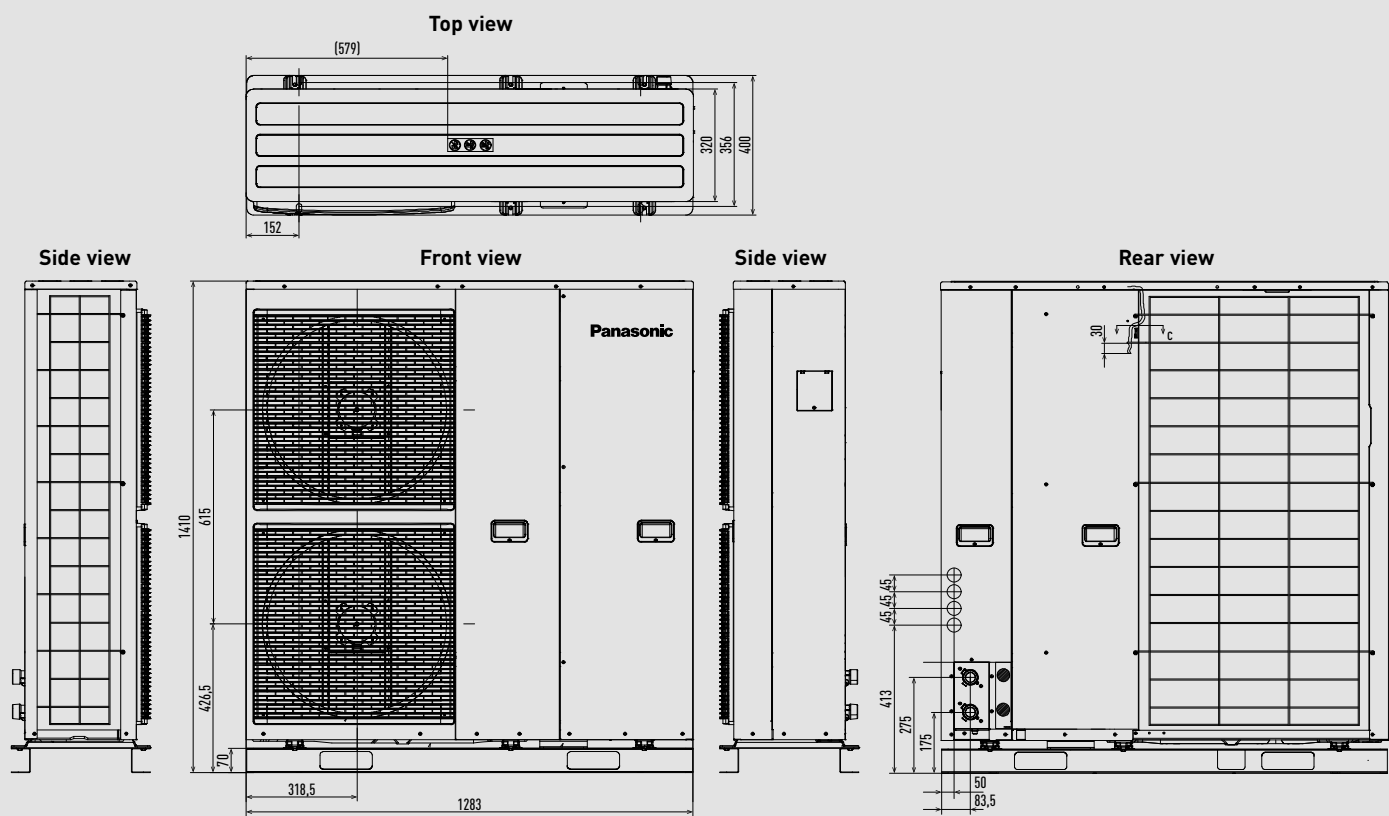

Unit: mm

Aquarea Air Smart fan coil floor standing.

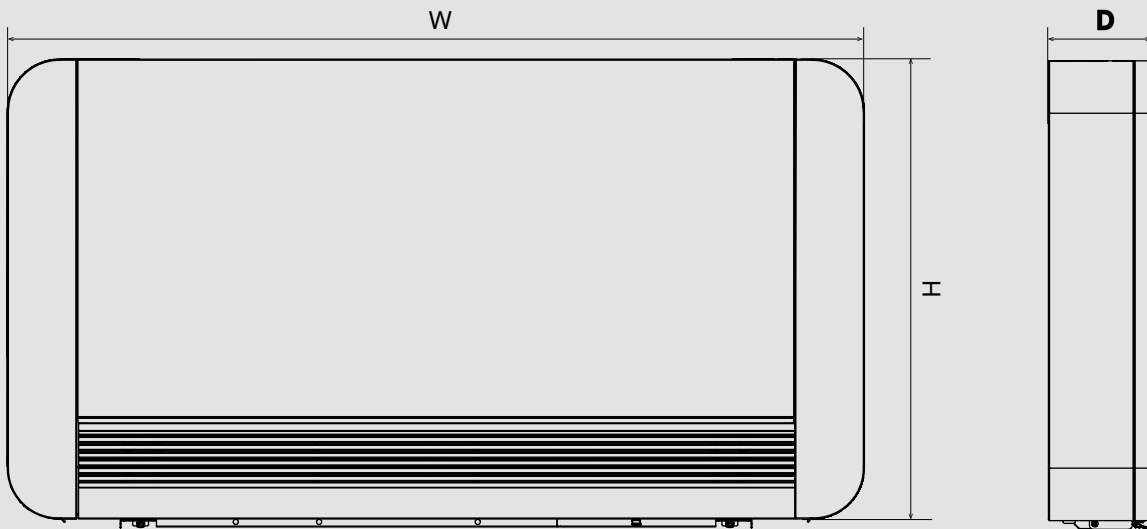

	H (mm)	W (mm)	D (mm)
P-FAL10	579	735	129
P-FAL20	579	935	129
P-FAL30	579	1135	129
P-FAL35	579	1335	129
P-FAL40	579	1535	129

Unit: mm

Aquarea Air Smart fan coil wall-mounted.

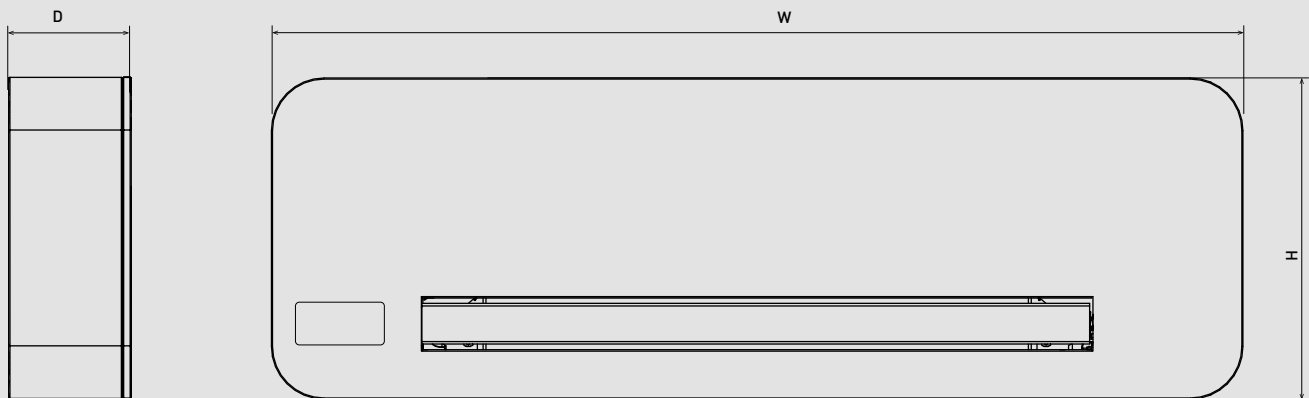

	H (mm)	W (mm)	D (mm)
P-FMM10	335	815	128
P-FMM15	335	1015	128
P-FMM20	335	1215	128
P-FMM40	335	1215	215

Unit: mm

Aquarea Air Smart fan coil ducted thin - P-FTN15 / P-FTN20 / P-FTN25.

P-FTN15

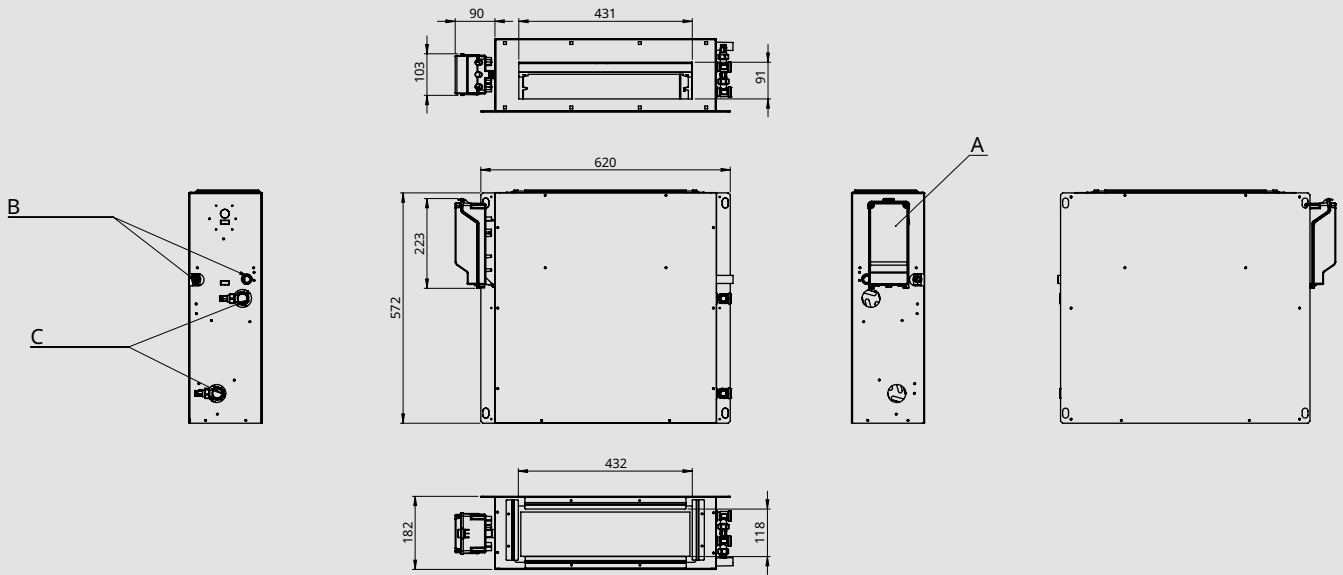

P-FTN20

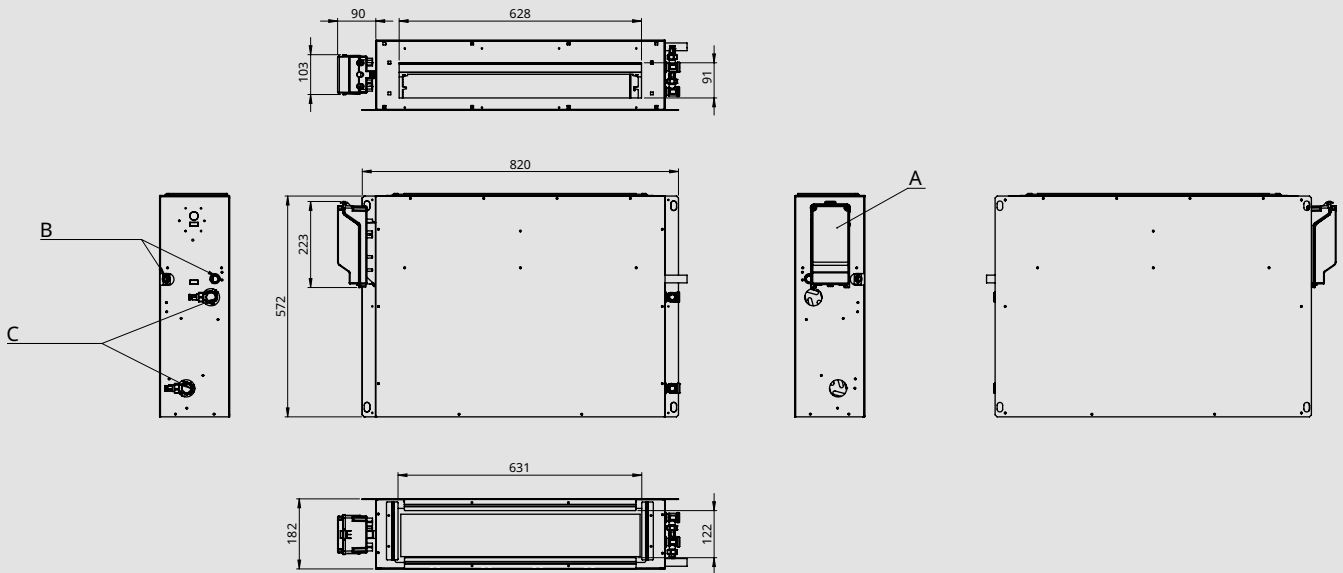

P-FTN25

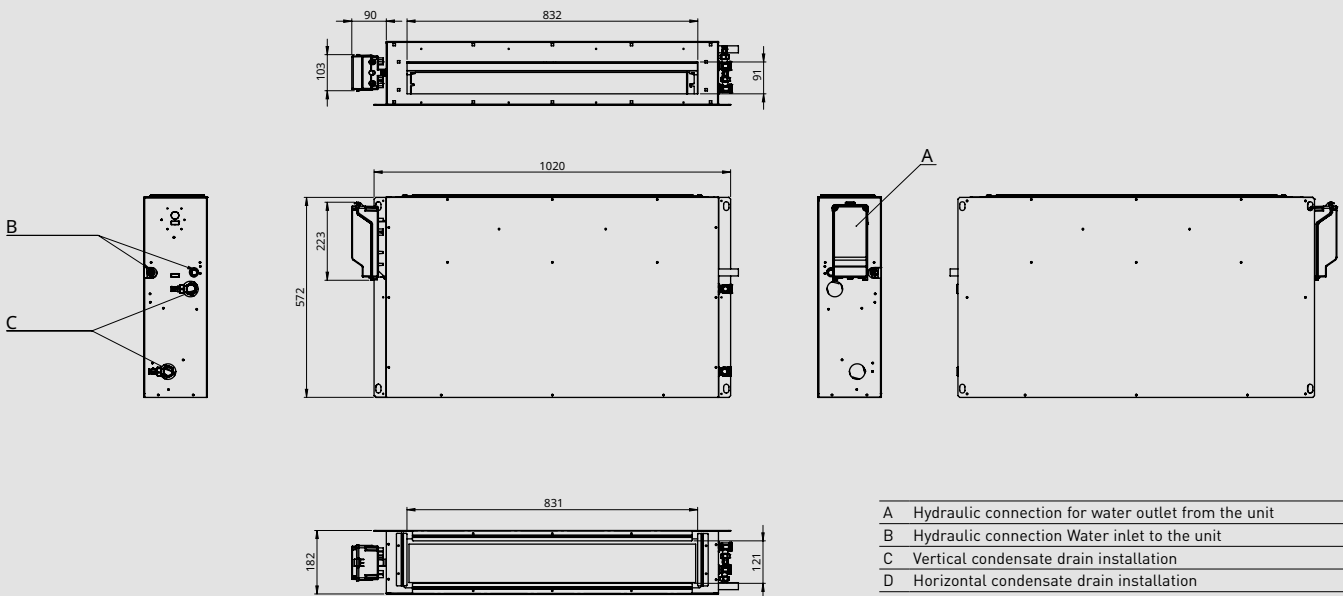

- A Hydraulic connection for water outlet from the unit
- B Hydraulic connection Water inlet to the unit
- C Vertical condensate drain installation
- D Horizontal condensate drain installation
- E Electrical panel

Unit: mm

Aquarea Air Smart fan coil ducted thin - P-FTN35 / P-FTN45.

P-FTN35

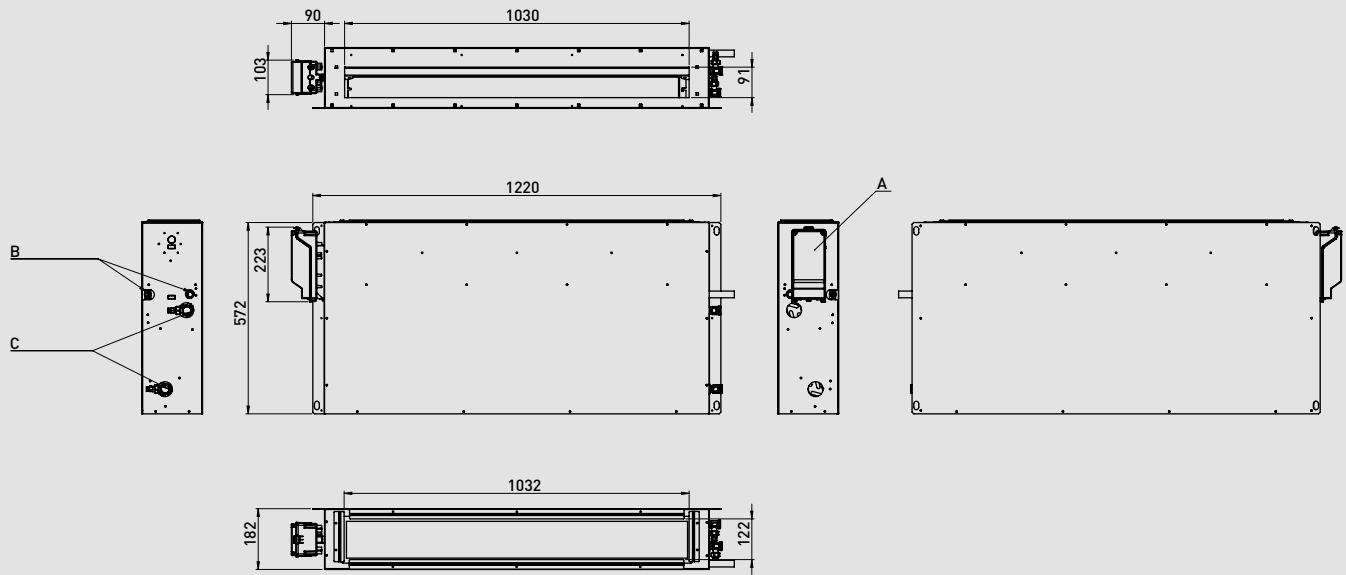

P-FTN45

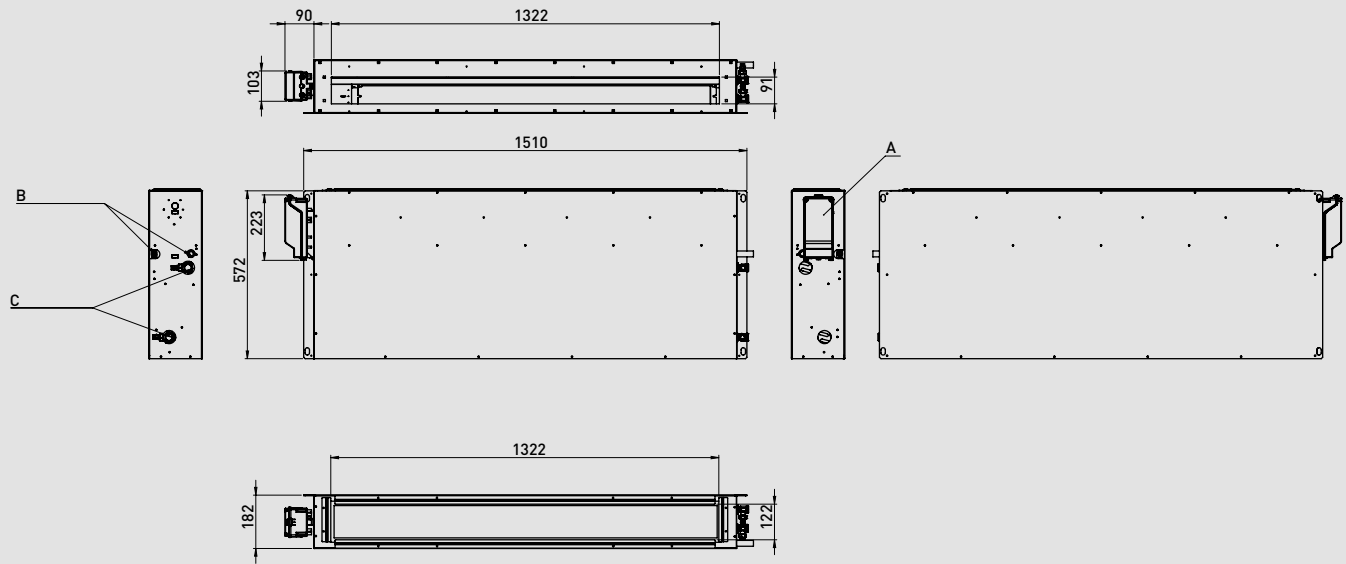

- A Hydraulic connection for water outlet from the unit
- B Hydraulic connection Water inlet to the unit
- C Vertical condensate drain installation
- D Horizontal condensate drain installation
- E Electrical panel

Unit: mm

Aquarea Air Smart fan coil ducted - P-FSN20 / P-FSN25 / P-FSN35.

P-FSN20

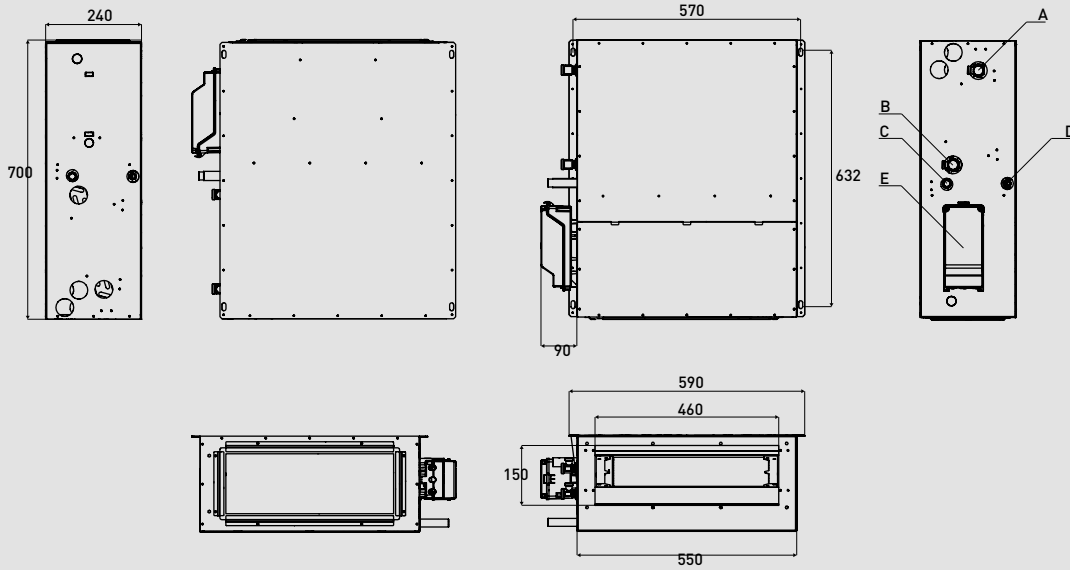

P-FSN25

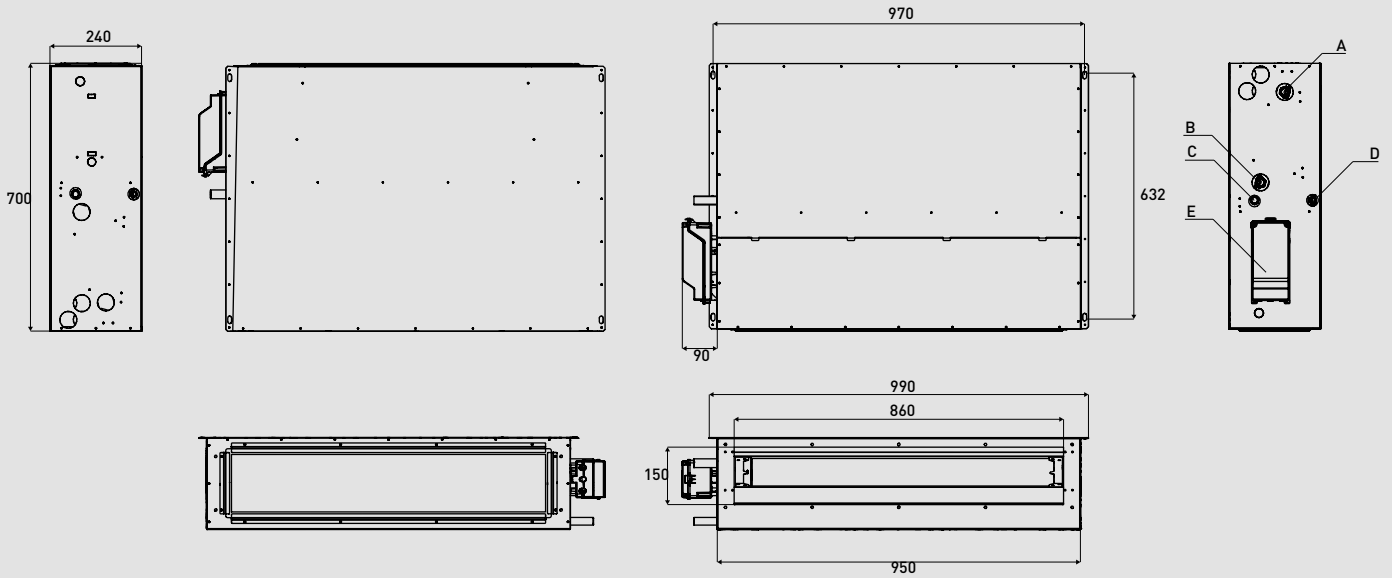

P-FSN35

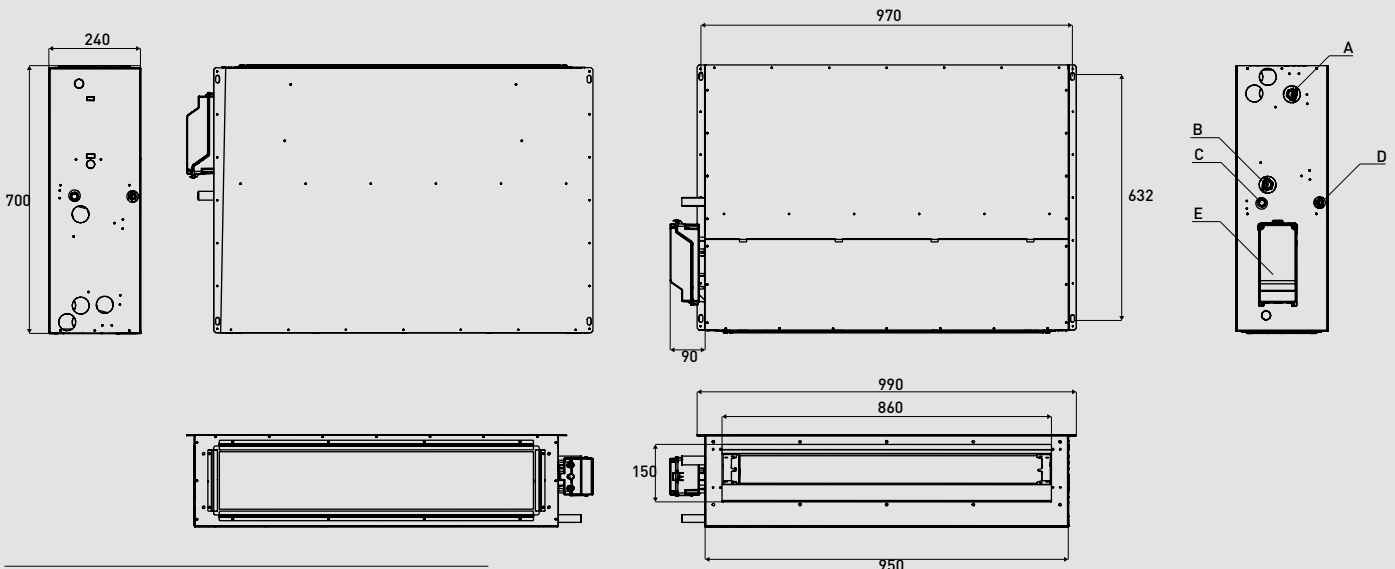

- A Hydraulic connection for water outlet from the unit
- B Hydraulic connection Water inlet to the unit
- C Vertical condensate drain installation

- D Horizontal condensate drain installation
- E Electrical panel

Unit: mm

Aquarea Air Smart fan coil ducted - P-FSN45 / P-FSN55.

P-FSN45

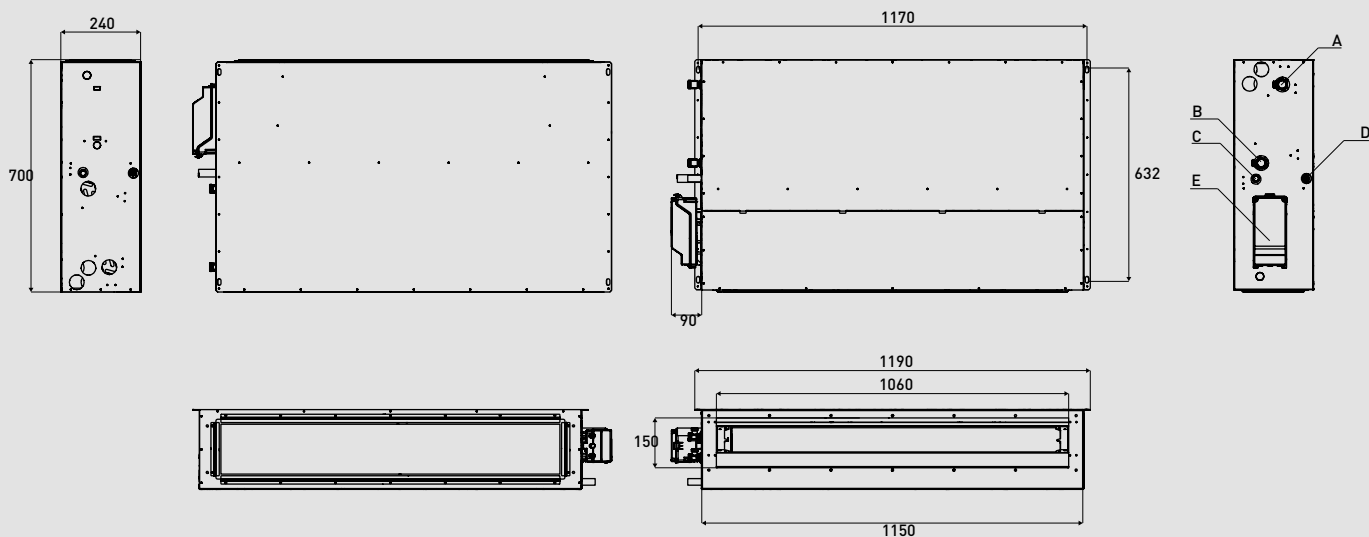

P-FSN55

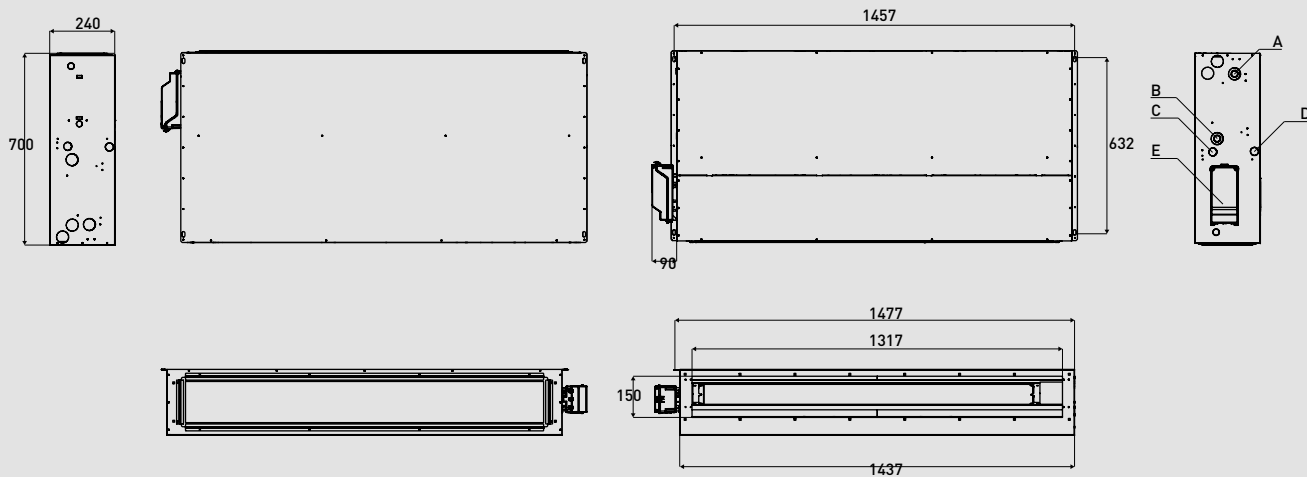

- A Hydraulic connection for water outlet from the unit
- B Hydraulic connection Water inlet to the unit
- C Vertical condensate drain installation
- D Horizontal condensate drain installation
- E Electrical panel

Unit: mm



Aquarea Air Smart fan coil ducted multi zone thin - P-FTQ30 / P-FTQ45.

P-FTQ30

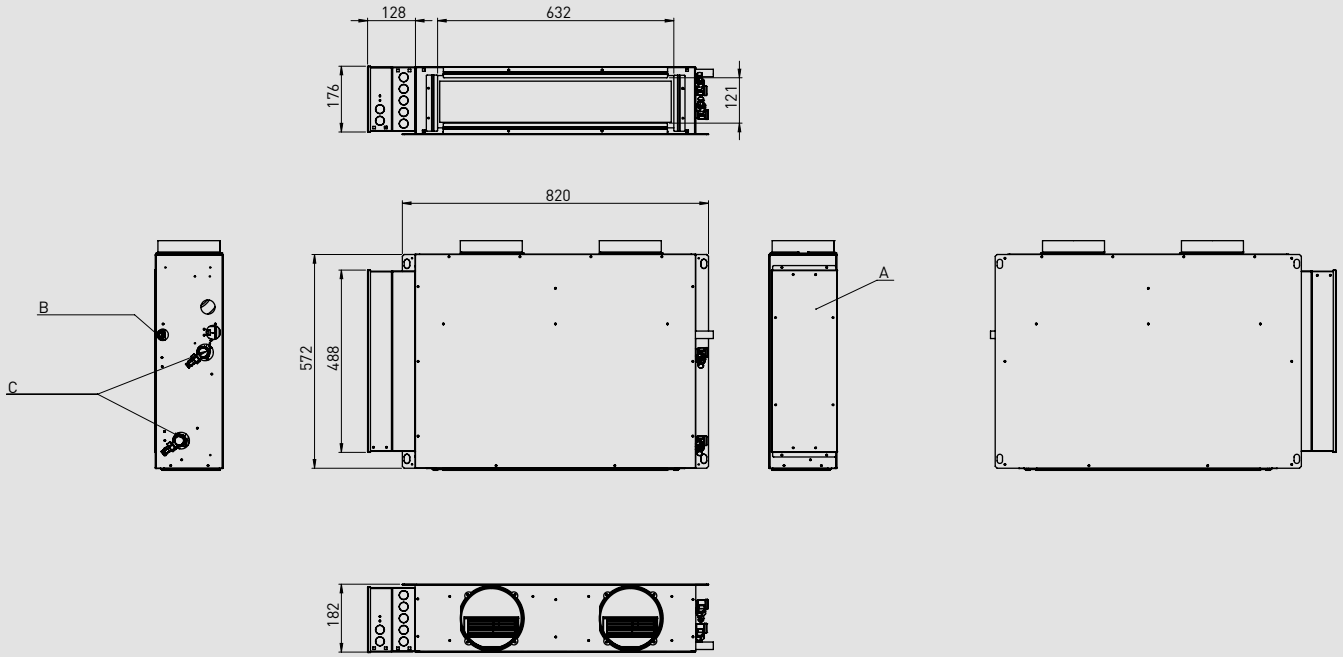

P-FTQ45

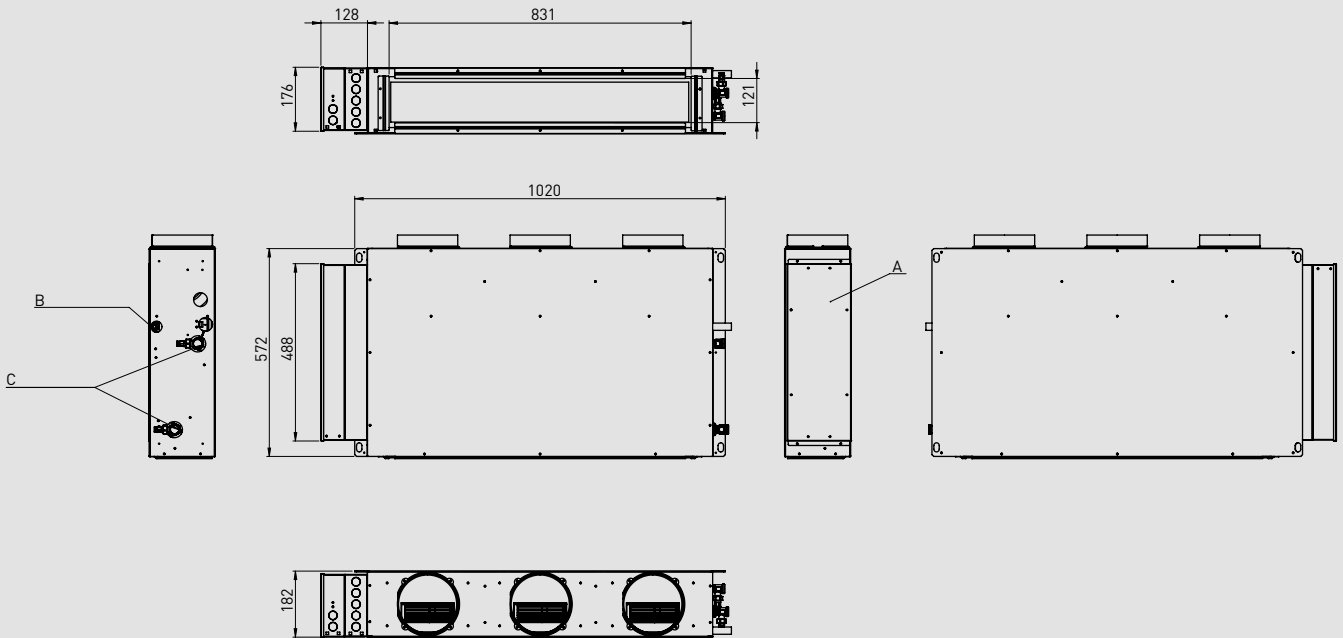

- A Electrical panel
- B Condensate drain
- C Hydraulic connections

Unit: mm

Aquarea Air Smart fan coil ducted multi zone thin - P-FTQ60 / P-FTQ65.

P-FTQ60

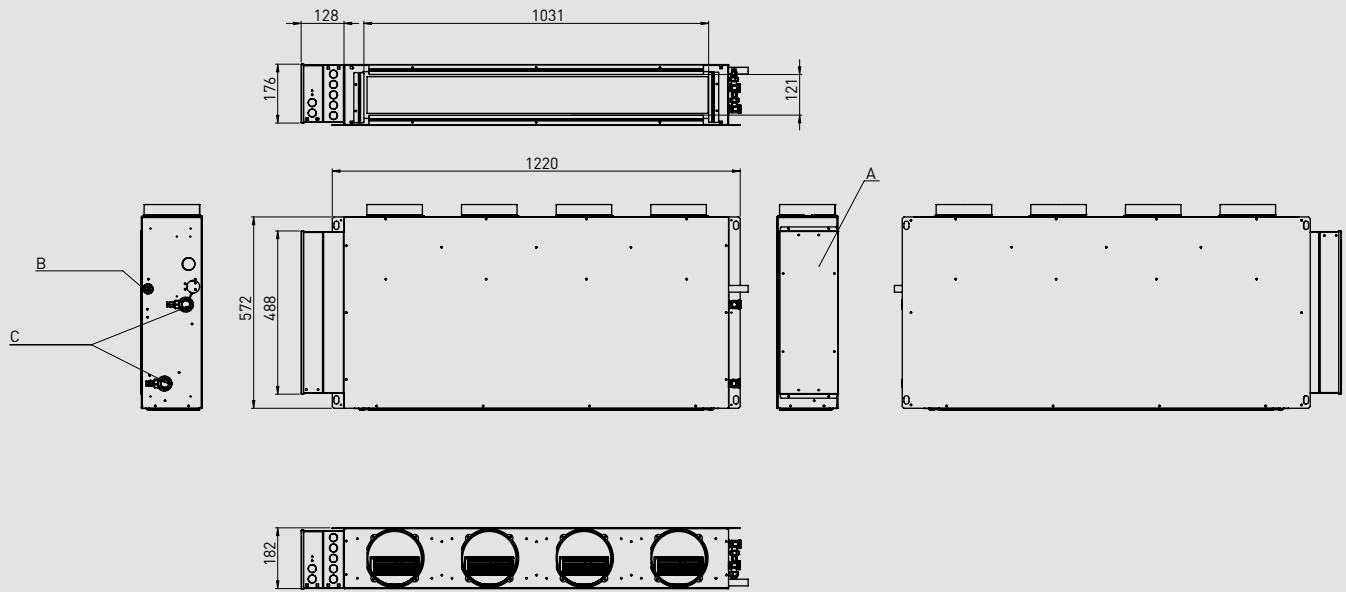

P-FTQ65

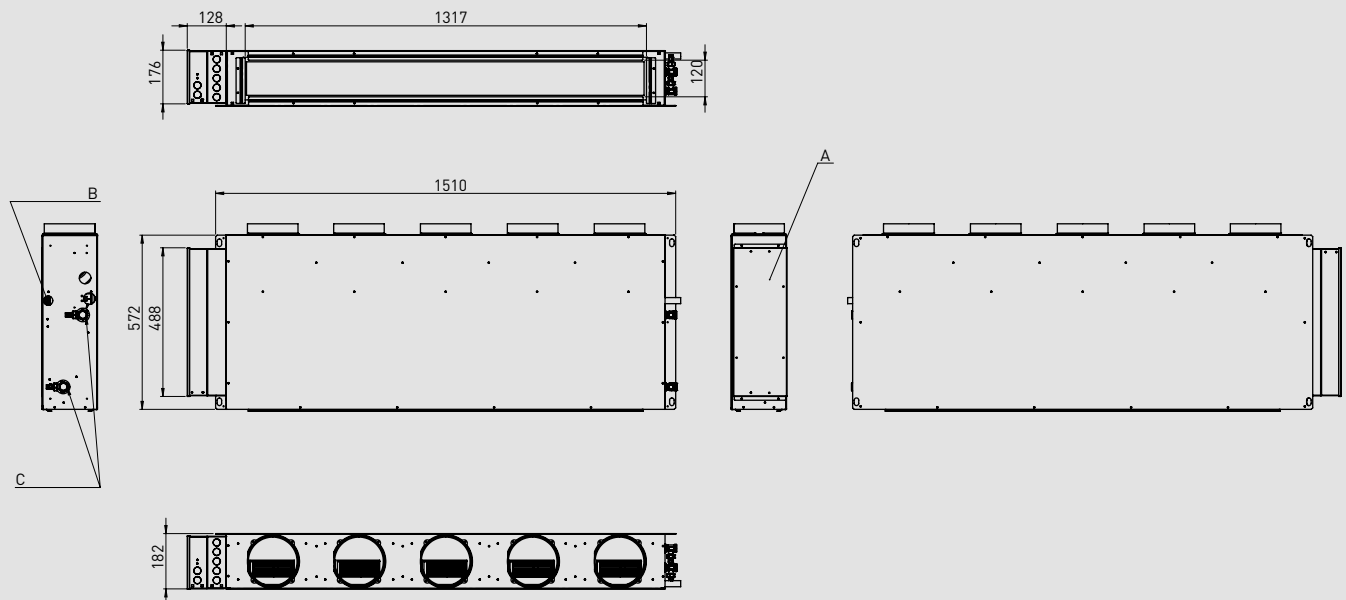

- A Electrical panel
- B Condensate drain
- C Hydraulic connections

Unit: mm

Aquarea Air Smart fan coil ducted multi zone - P-FSQ30 / P-FSQ45.

P-FSQ30

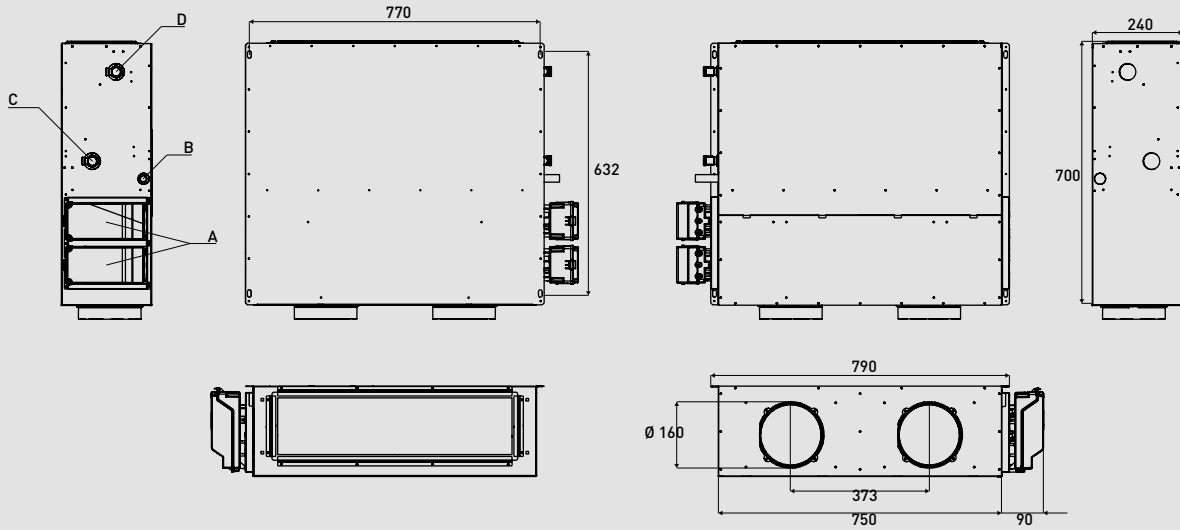

P-FSQ45

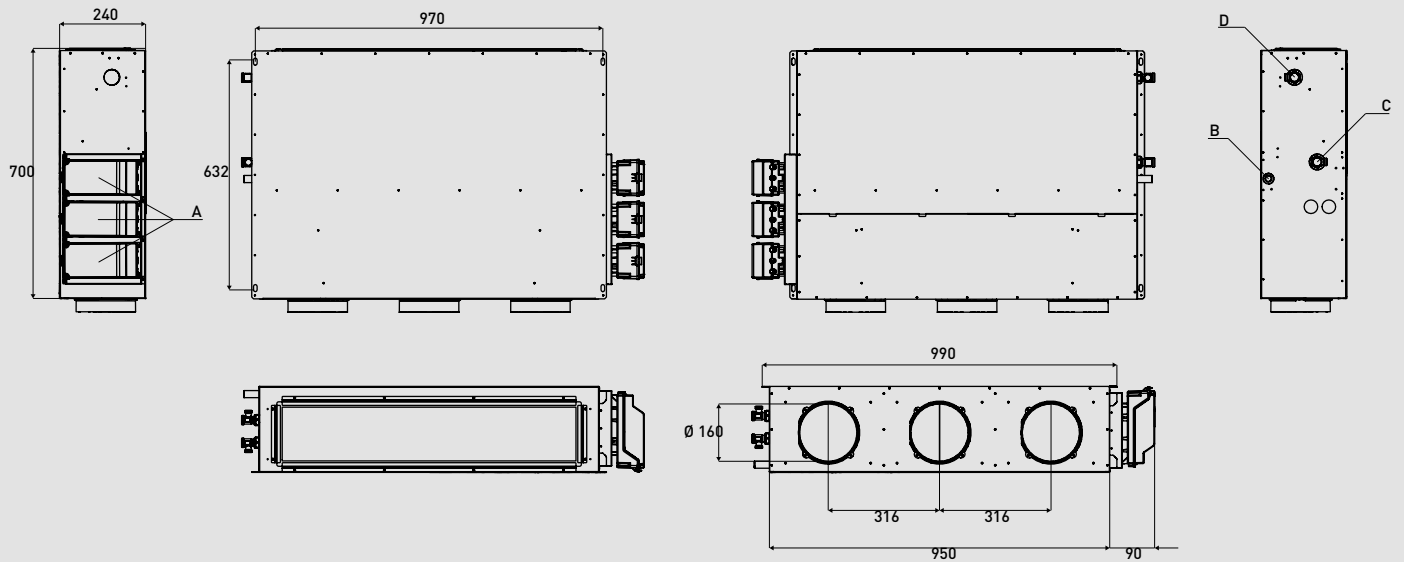

A	Electrical panel
B	Condensate drain
C	Water inlet
D	Water outlet

Unit: mm

Aquarea Air Smart fan coil ducted multi zone - P-FSQ60 / P-FSQ75.

P-FSQ60

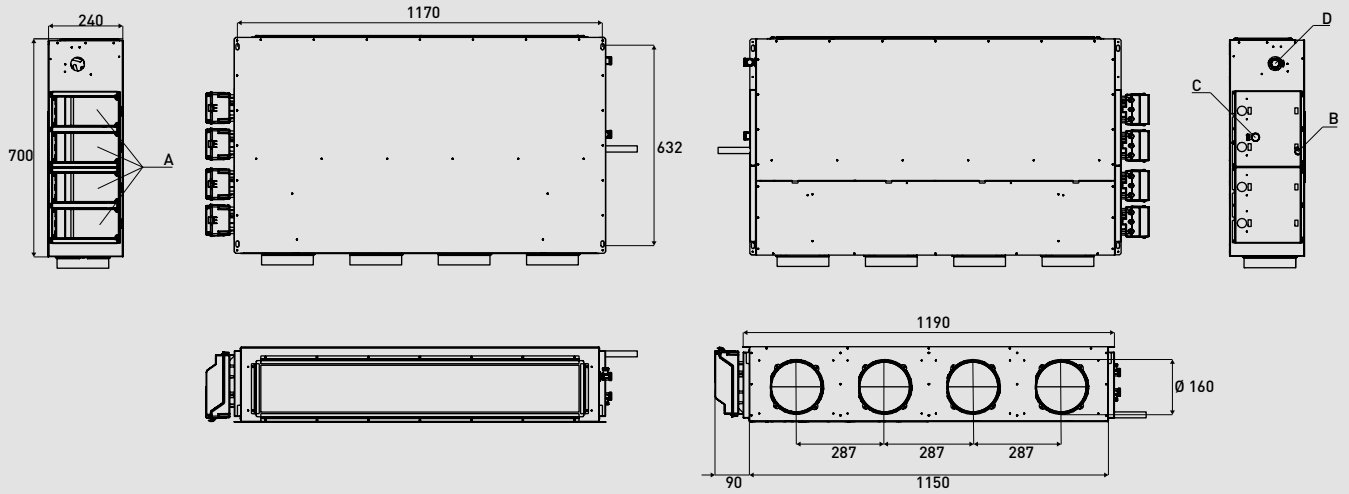

P-FSQ75

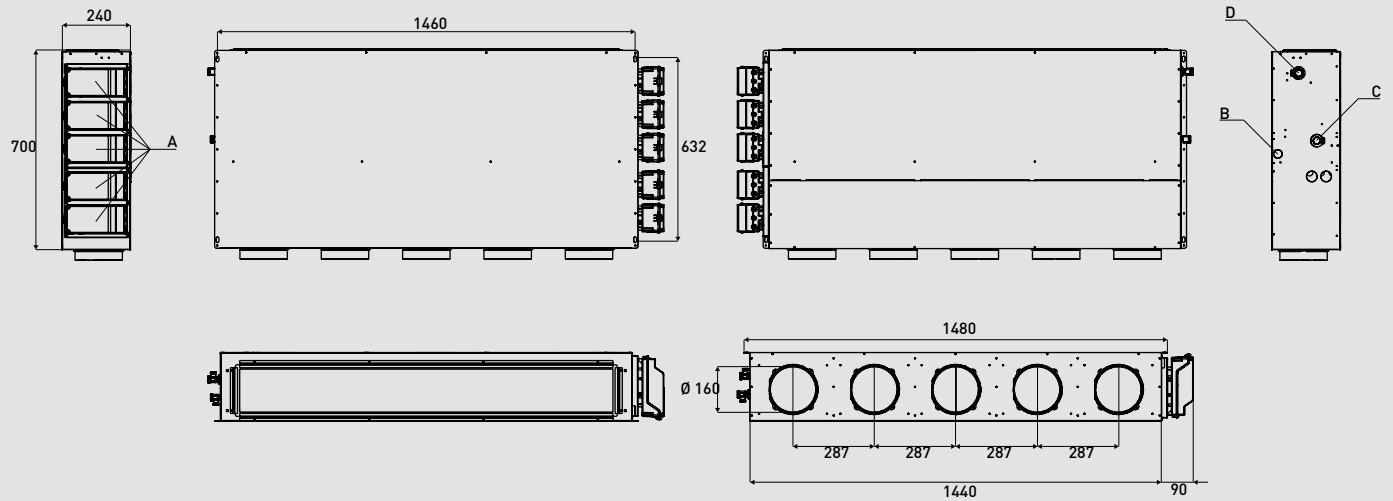

- A Electrical panel
- B Condensate drain
- C Water inlet
- D Water outlet

Unit: mm

Aquarea Loop

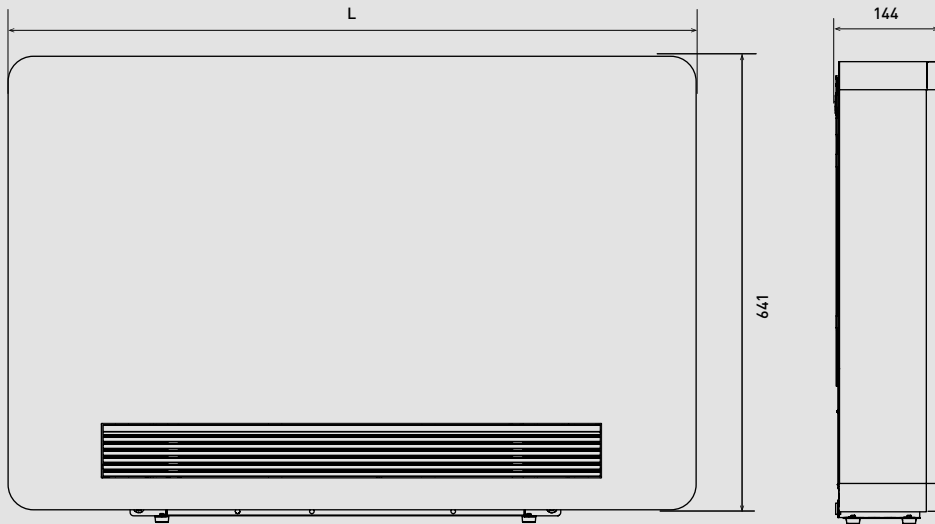

	L (mm)
P-CWSL10	775
P-CWSL20	975
P-CWSL30	1225

Unit: mm

Buffer tank - PAW-BTANK50L-2 / PAW-BTANK100L.

	A*	B*	C	D	E	Ø
PAW-BTANK50L-2	704	636	422	192	96	435
PAW-BTANK100L	1243	1175	962	192	96	435

Tolerance +/- 5 mm. \* Total height tolerance +0 / -13 mm.

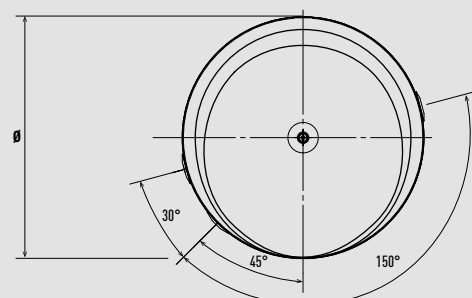
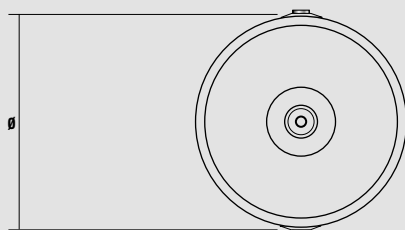
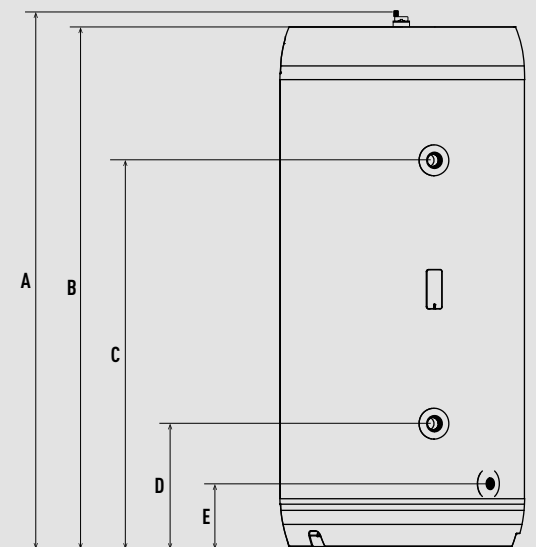
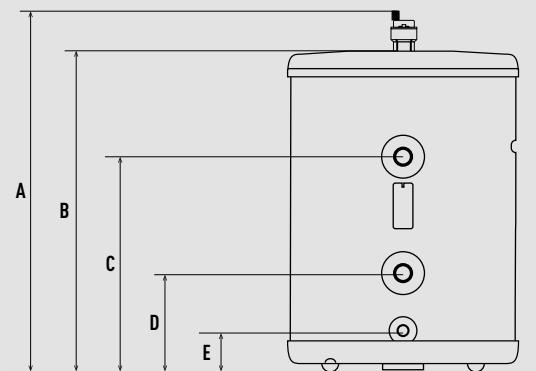

Unit: mm

Buffer tank - PAW-BTANKG200L / PAW-BTANKG260L.

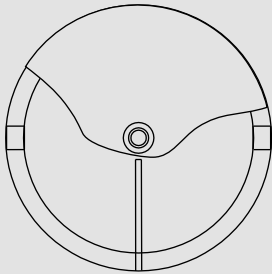
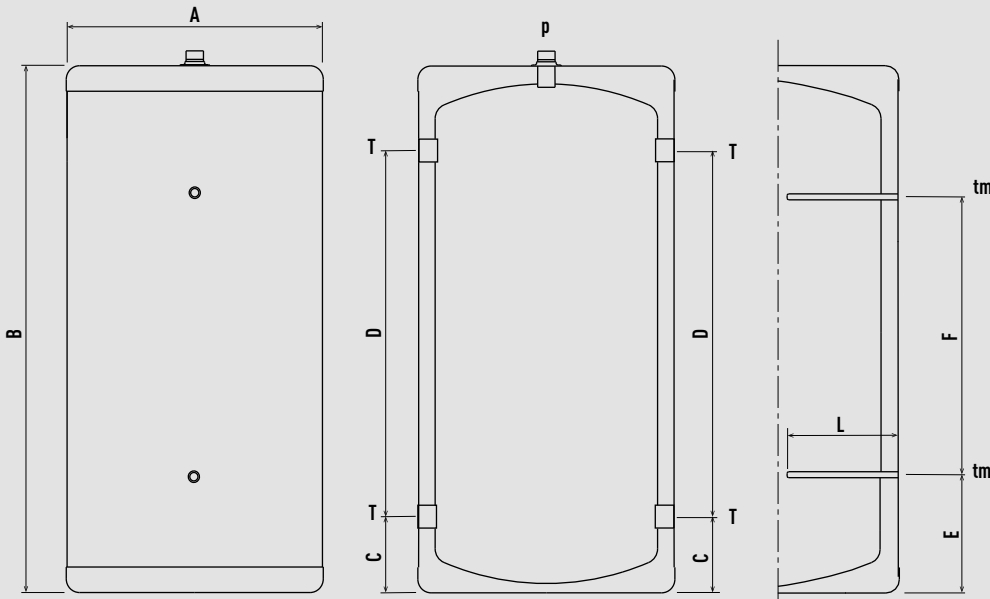

	A: External diameter	B: Overall height	C	D	E	F	L	T: connection	tm: probe tube for sensors	p: Purge
	mm	mm	mm	mm	mm	mm	mm	Inch G/F	Ø int. (mm)	Inch G/M
PAW-BTANKG200L	620	983	168	624	194	566	285	1 1/2	10	1
PAW-BTANKG260L	620	1293	168	873	279	652	285	1 1/2	10	1

Unit: mm

Enamelled tank - PAW-TA15C1E5.

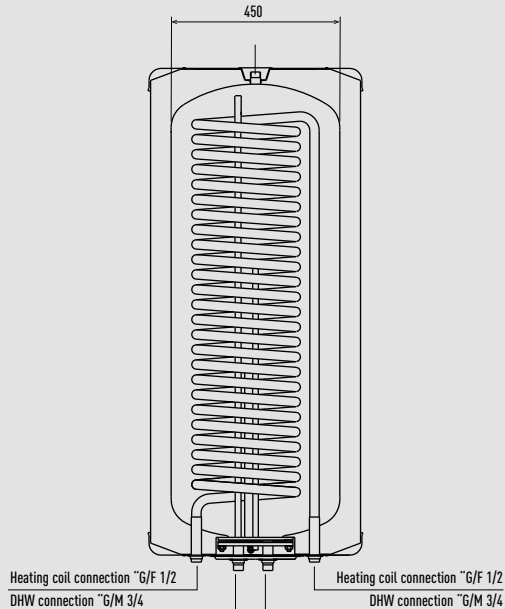
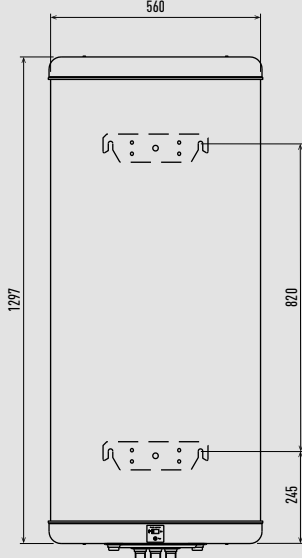
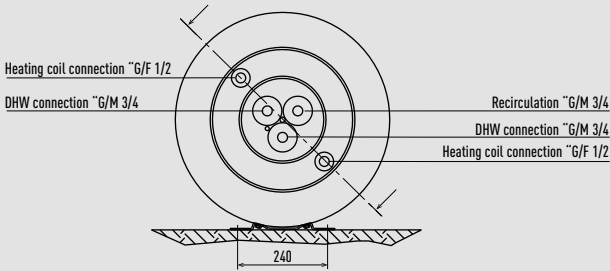

Unit: mm

Enamelled tanks - PAW-TA20C1E5STD / PAW-TA30C1E5STD / PAW-TA40C1E5STD.

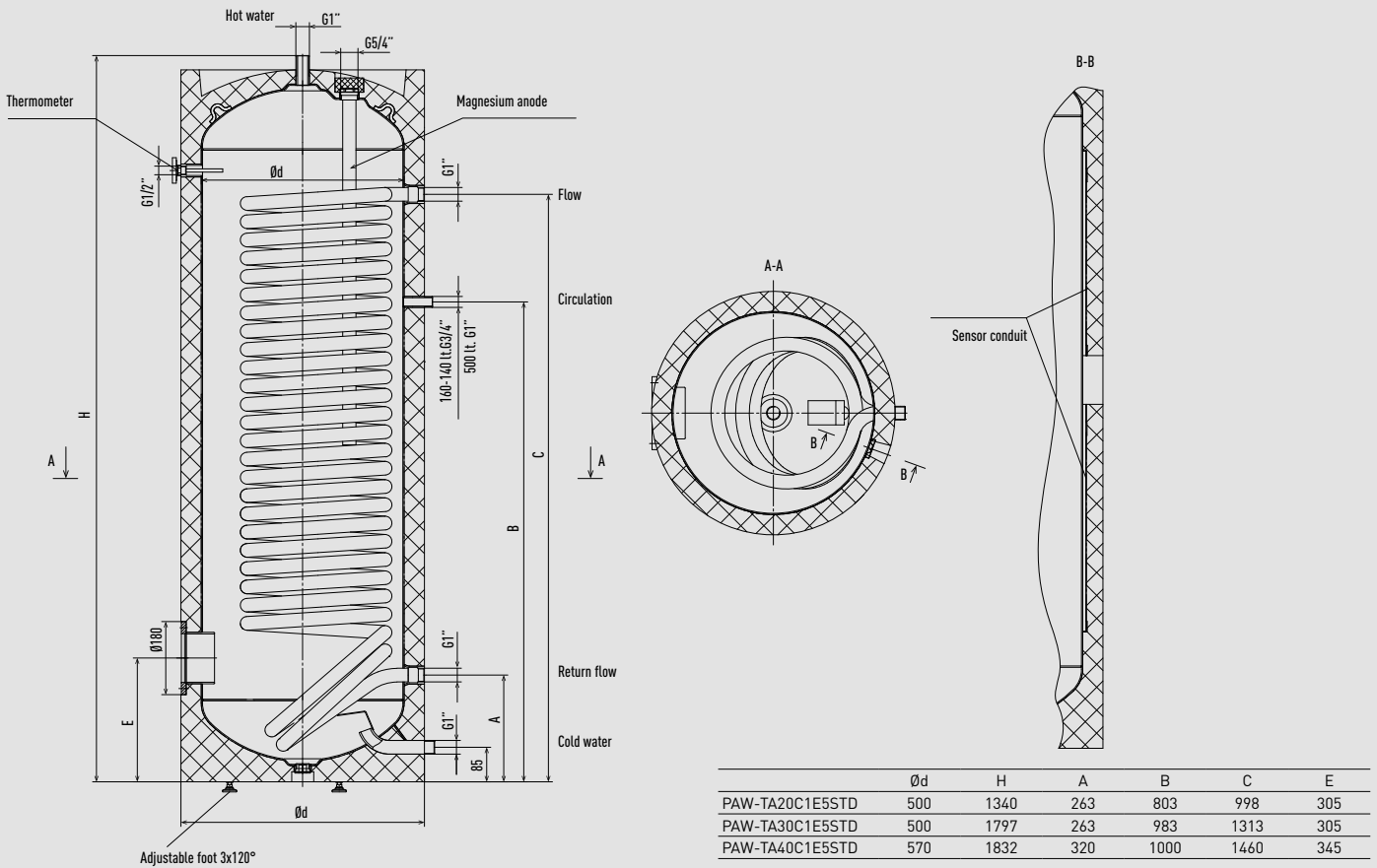

Unit: mm

Enamelled tank - PAW-TA30C2E5STD.

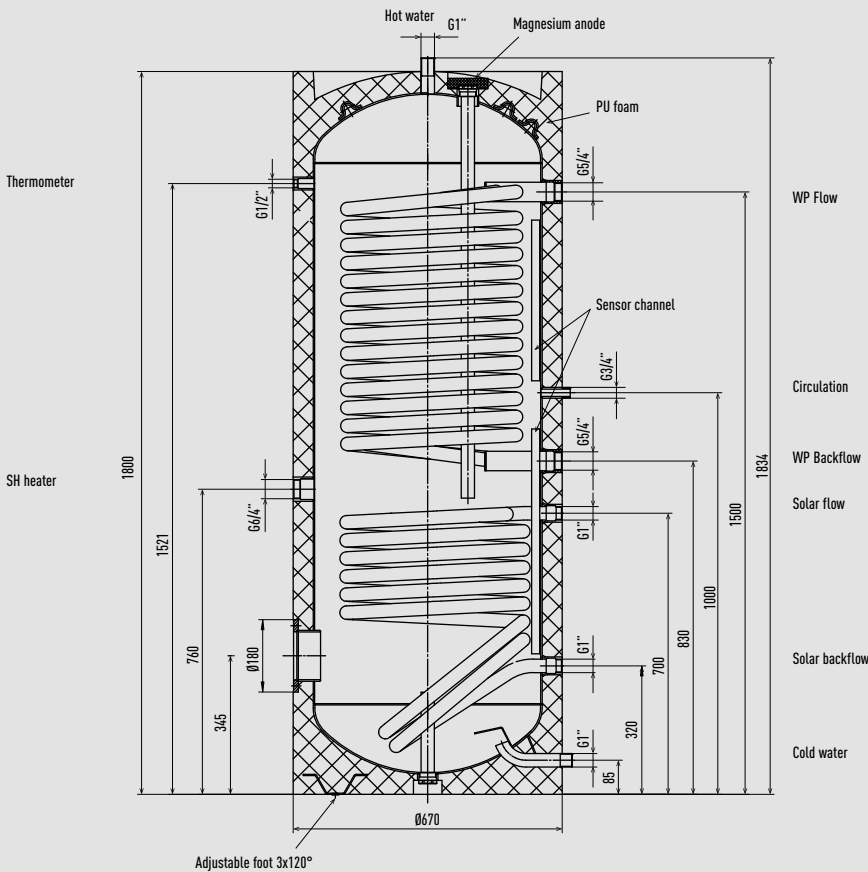

Unit: mm

Stainless steel tanks - PAW-TD20C1E5-1 / PAW-TD30C1E5-1 / PAW-TD30C1E5HI-1.

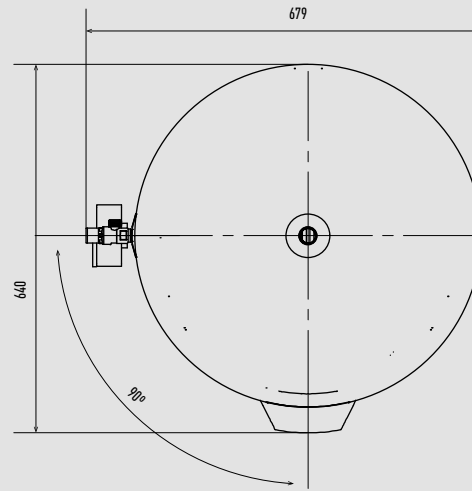
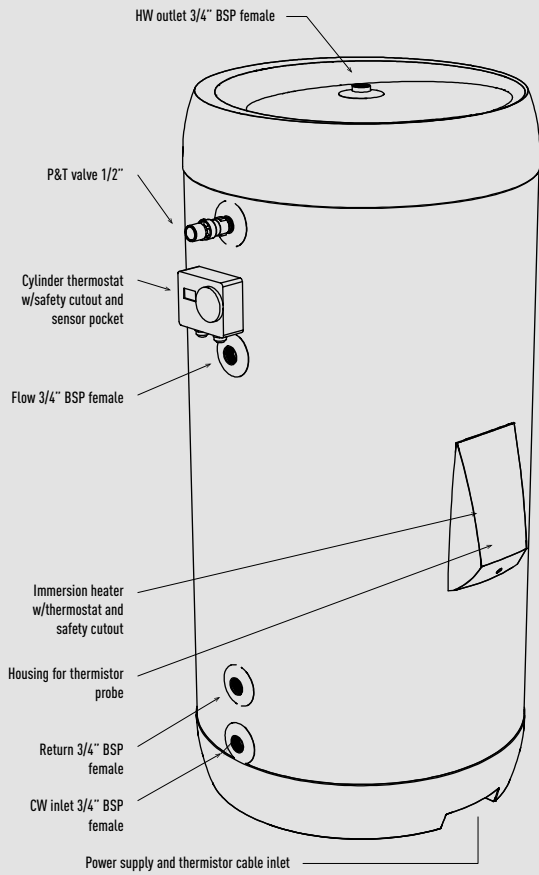

Unit: mm

Heat recovery ventilation unit.

Side view

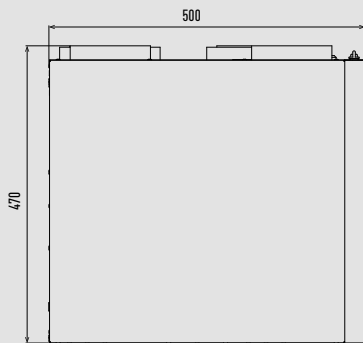

PAW-A2W-VENTA-L

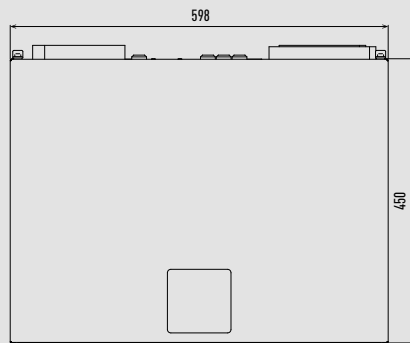

PAW-A2W-VENTA-R

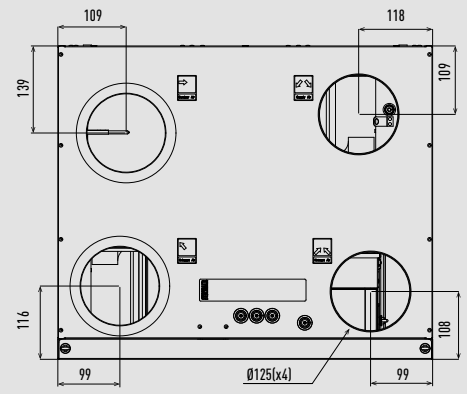
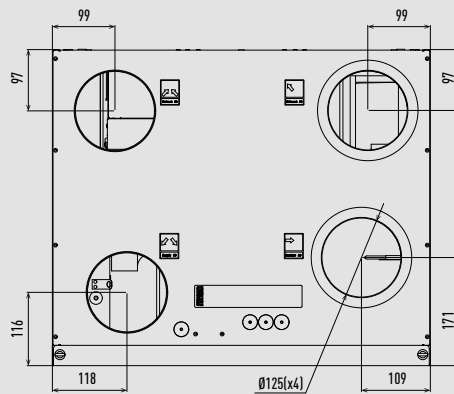
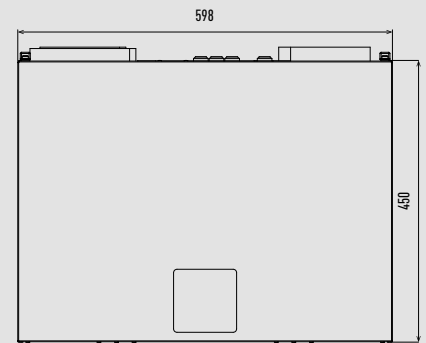

Unit: mm



Wall-mounted Heatcharge VZ.

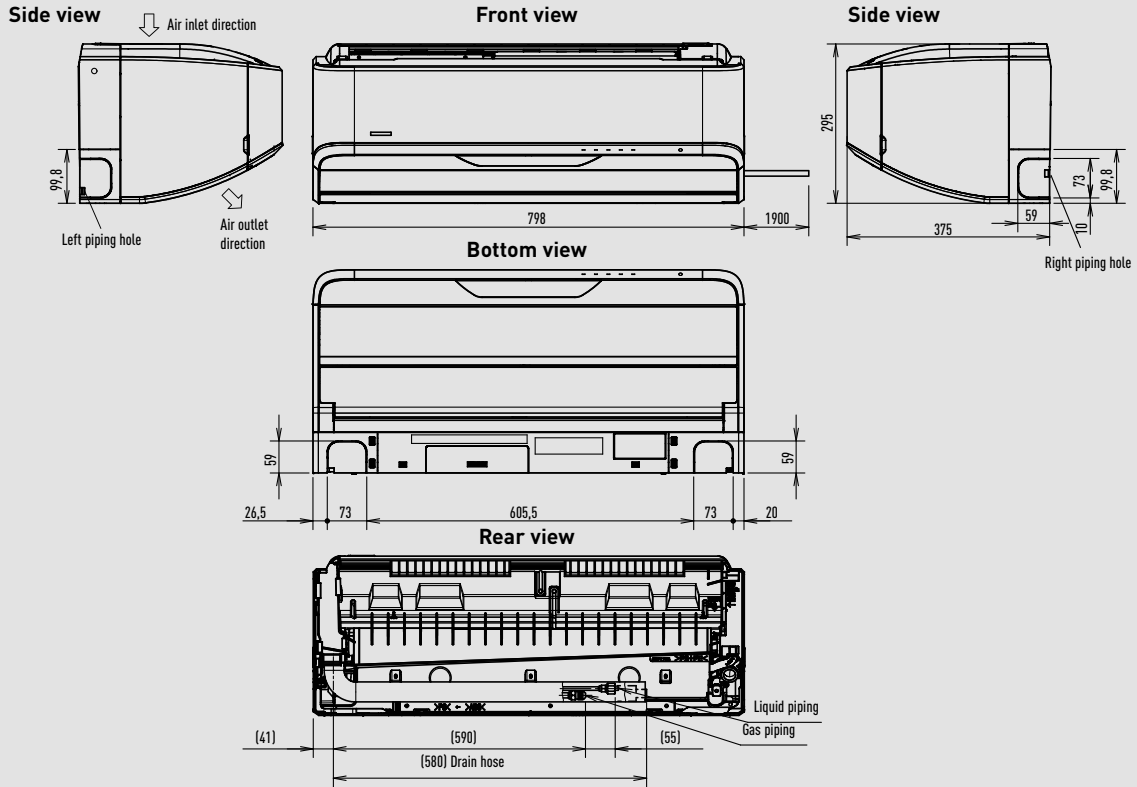

Relative position between the indoor unit and the installation plate

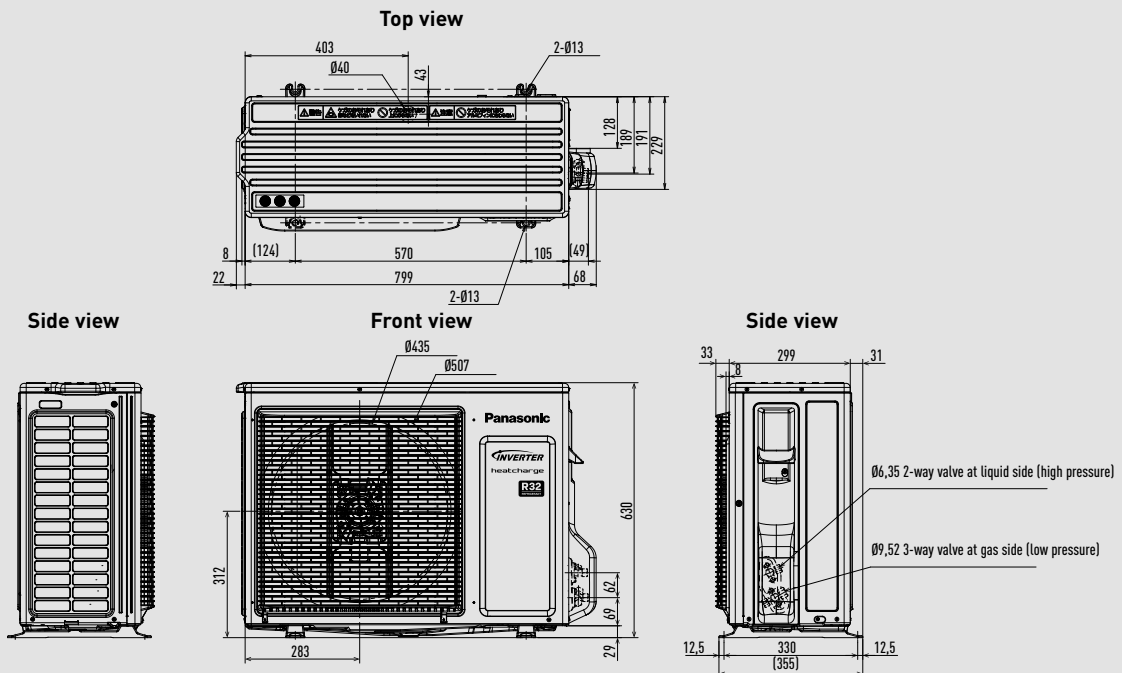
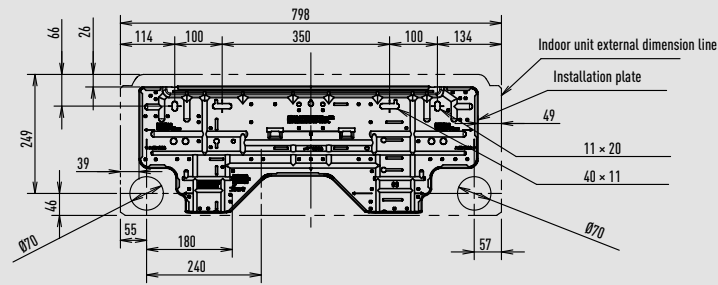

Wall-mounted Etherea (from 1,6 to 4,2 kW).

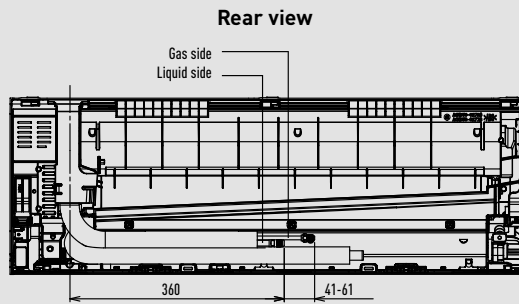
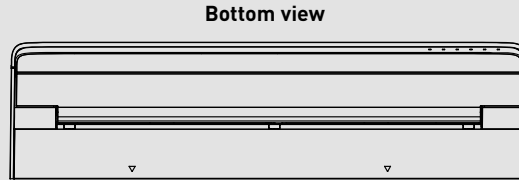
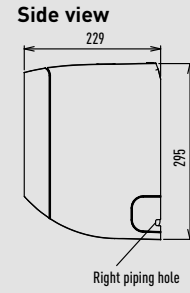
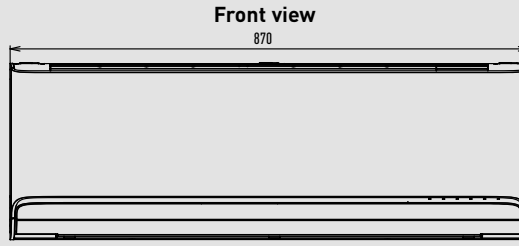
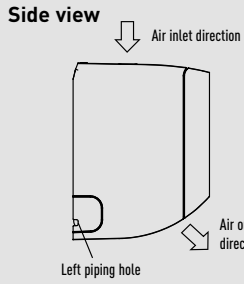

Relative position between the indoor unit and the installation plate

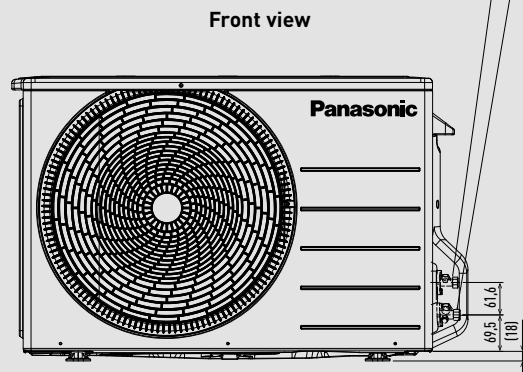
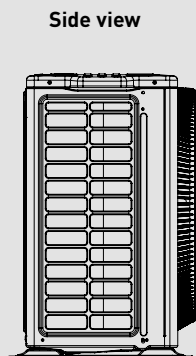
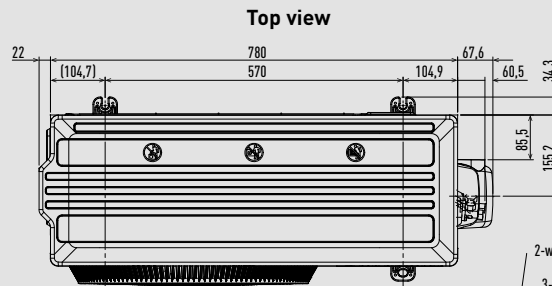
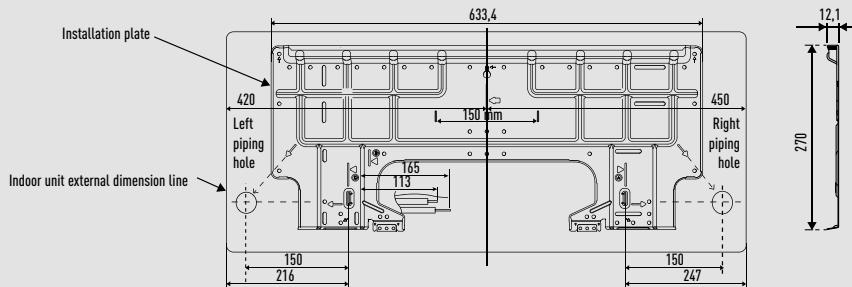

2-way valve at liquid side (high pressure)  
3-way valve at gas side (low pressure)

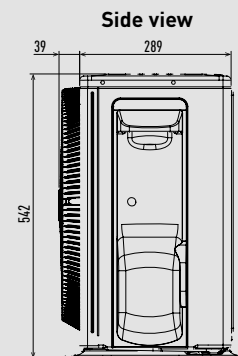

Wall-mounted Etherea (5,0 and 7,1 kW).

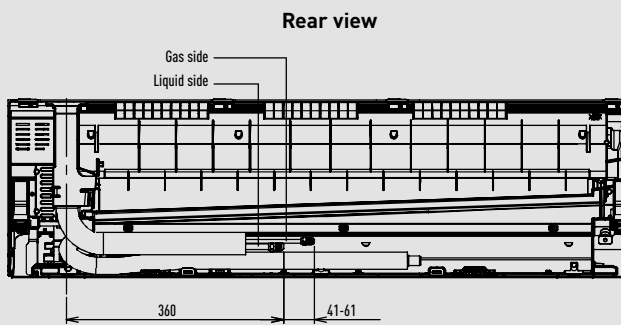
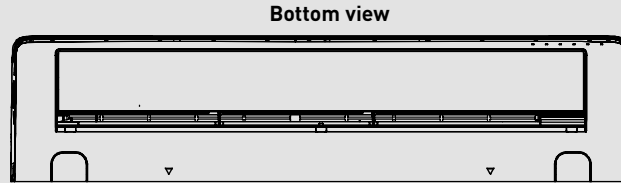
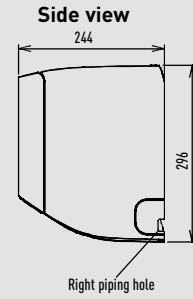
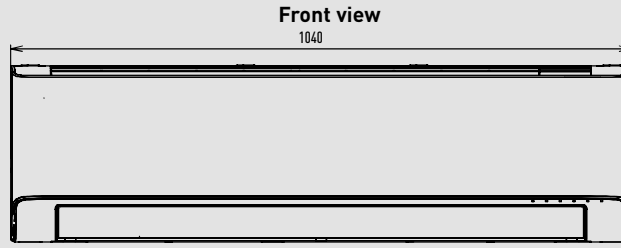
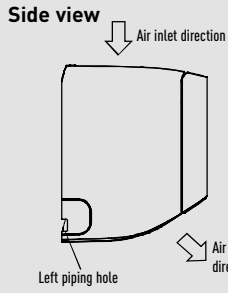

Relative position between the indoor unit and the installation plate

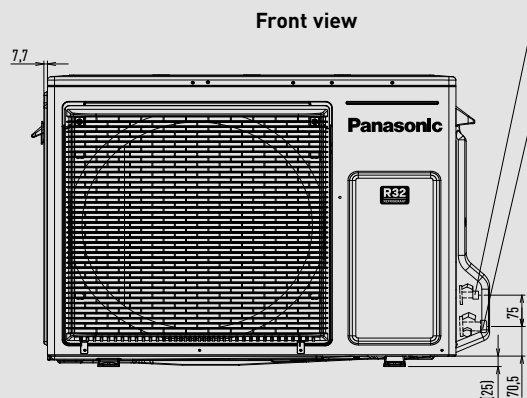
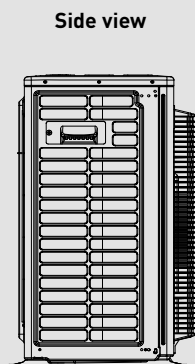
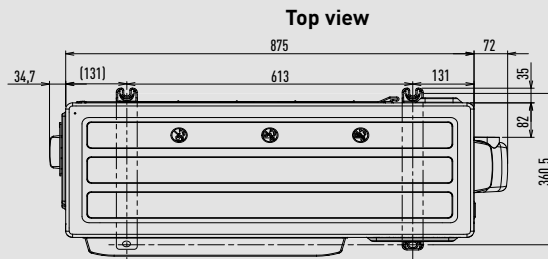
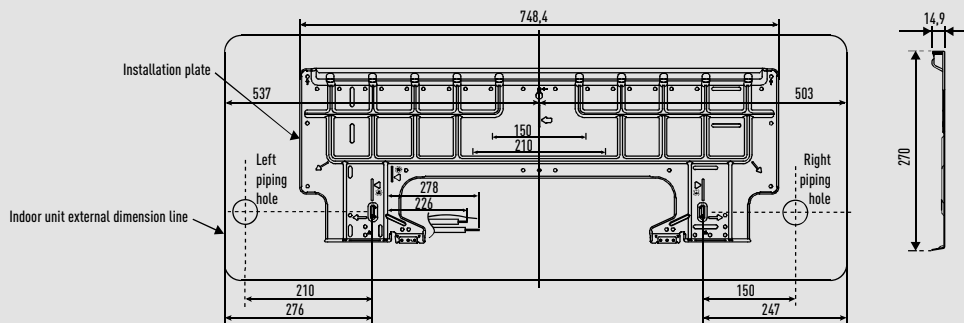

2-way valve at liquid side (high pressure)

3-way valve at gas side (low pressure)

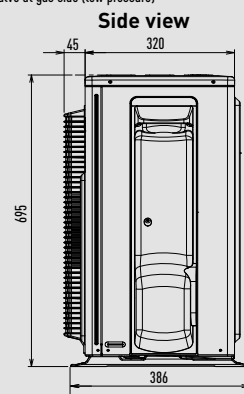

Wall-mounted TZ super-compact (from 1,6 to 5,0 kW).

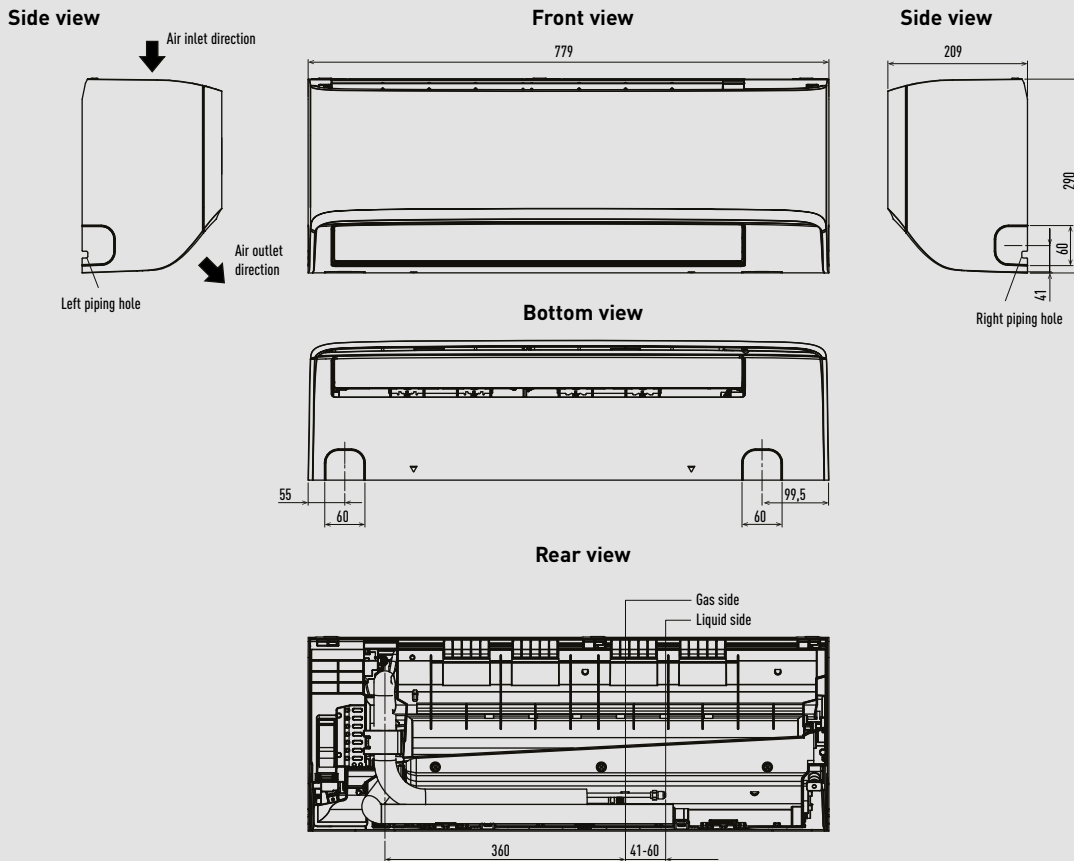

Relative position between the indoor unit and the installation plate

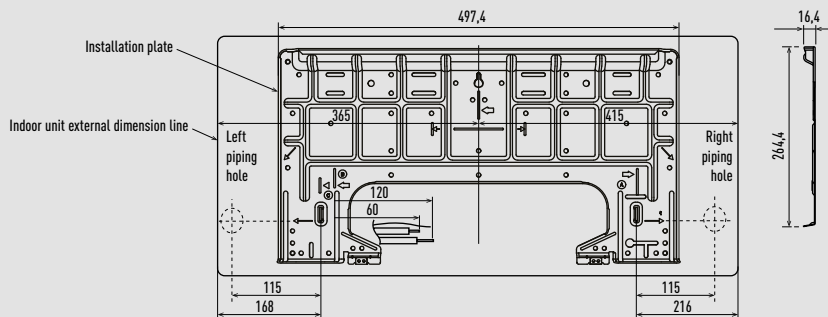

CU-TZ20ZKE / CU-TZ25ZKE / CU-TZ35ZKE / CU-TZ42ZKE

CU-TZ50ZKE

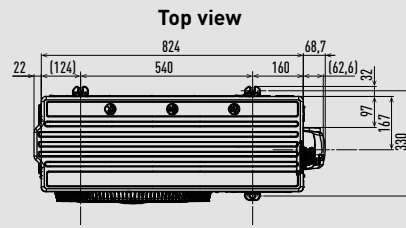
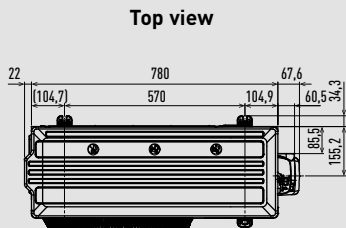

Side view

Front view

Side view

Side view

Front view

Side view

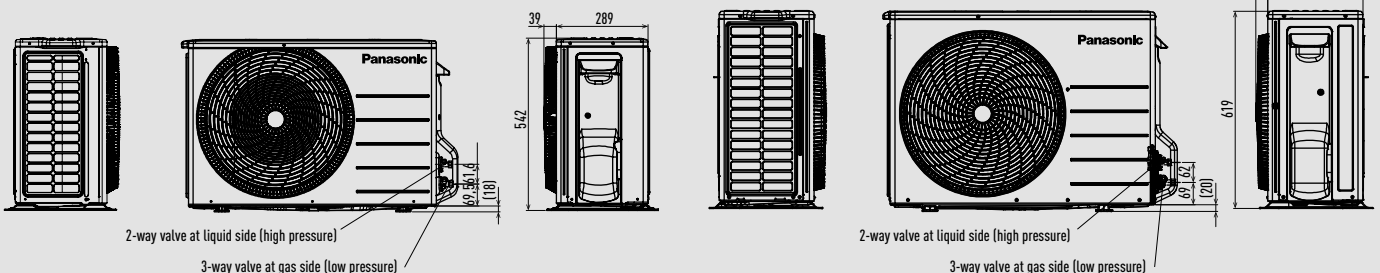

Unit: mm

Wall-mounted TZ super-compact (6,0 and 7,1 kW).

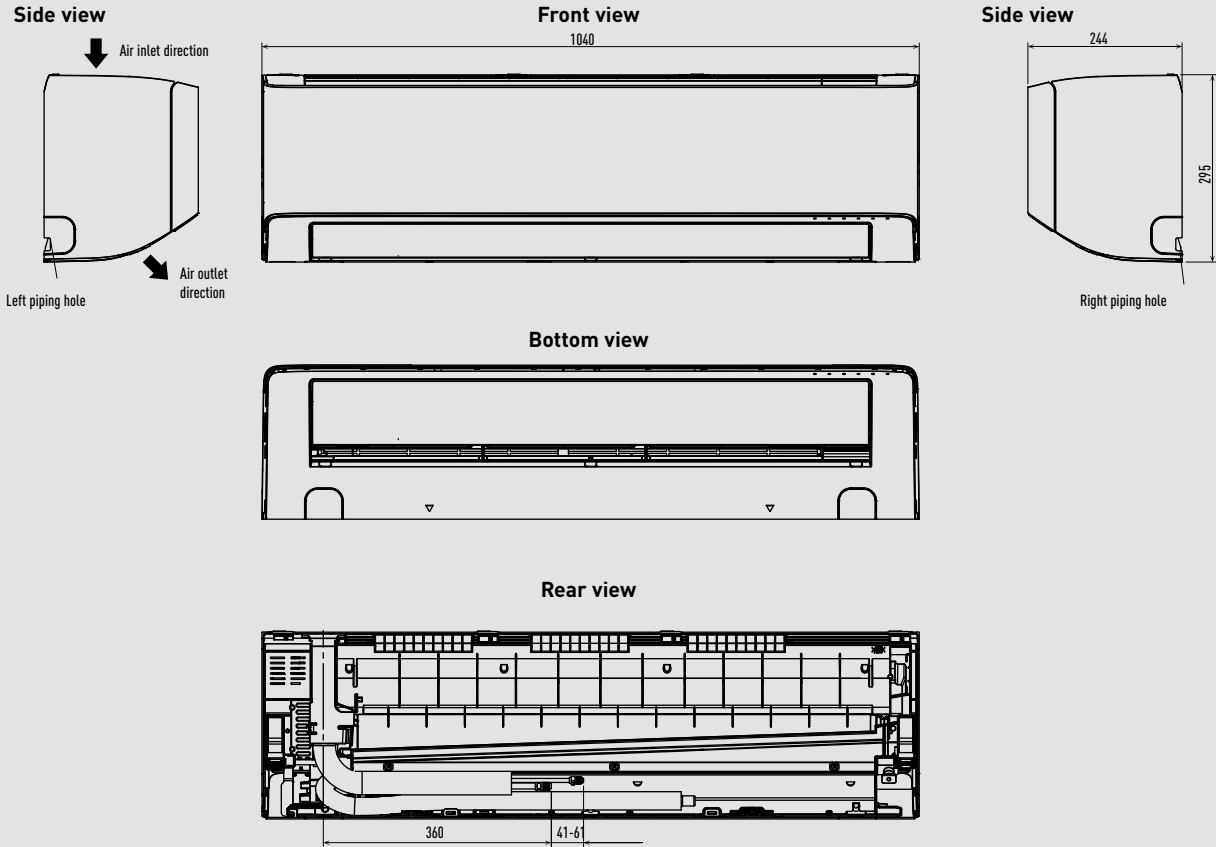

Relative position between the indoor unit and the installation plate

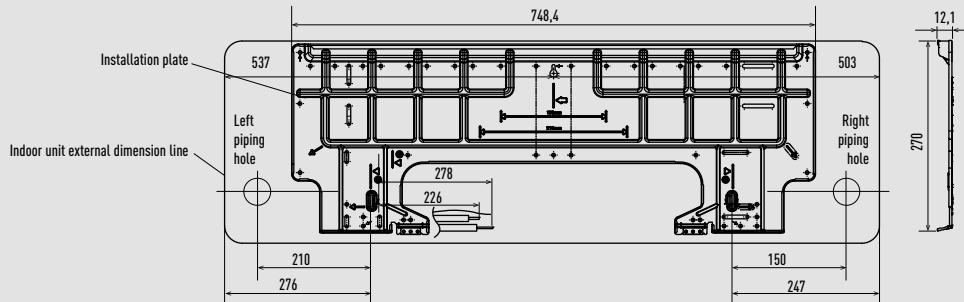

CU-TZ60ZKE

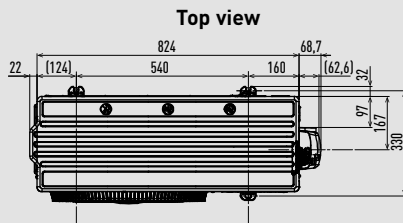

CU-TZ71ZKE

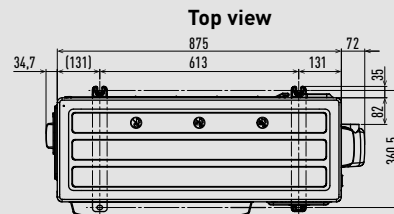

Side view

Front view

Side view

Side view

Front view

Side view

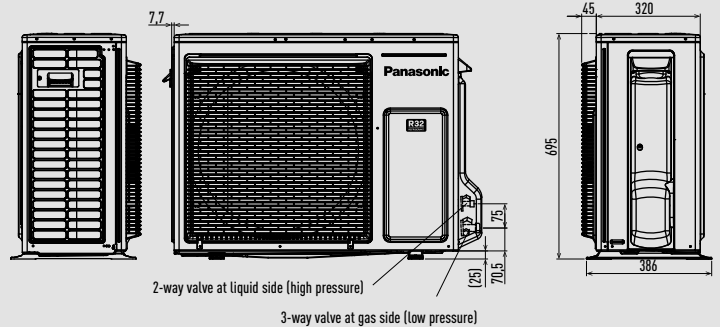
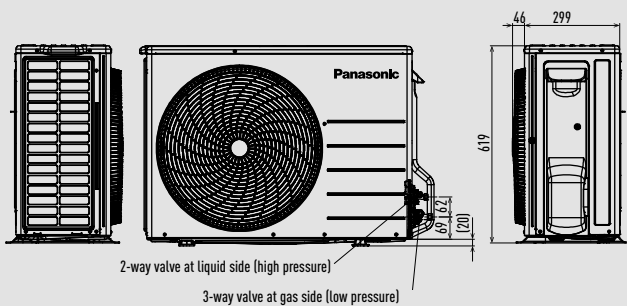

Unit: mm

Wall-mounted BZ super-compact.

Side view

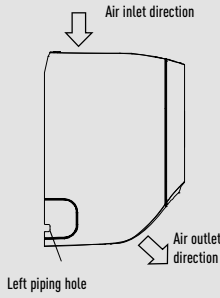

Front view



Side view

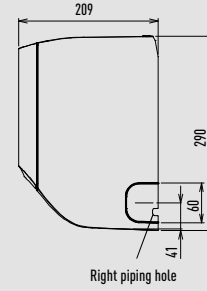

Bottom view

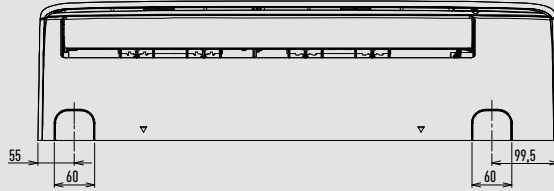

Rear view

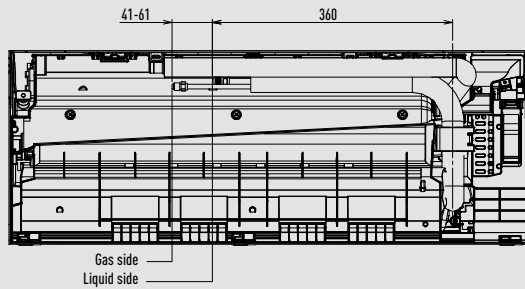

Relative position between the indoor unit and the installation plate

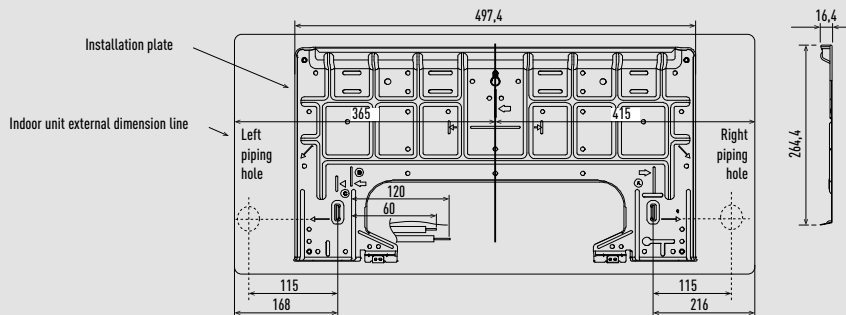

CU-BZ25ZKE / CU-BZ35ZKE

Top view

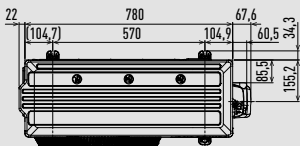

Front view

Side view

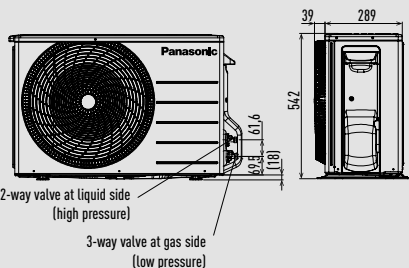

CU-BZ50ZKE

Top view

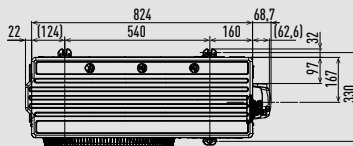

Front view

Side view

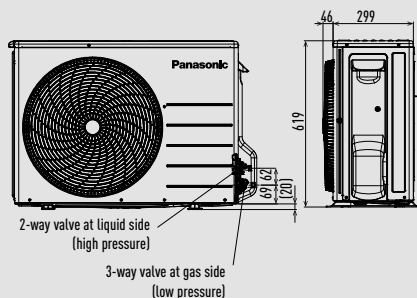

CU-BZ60ZKE

Top view

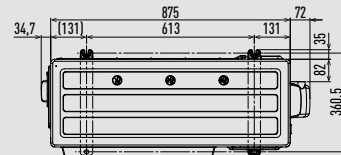

Front view

Side view

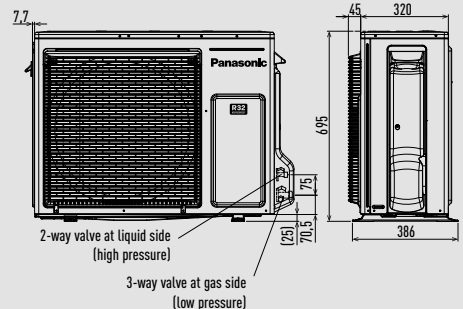

Unit: mm

Wall-mounted UZ super-compact.

Side view

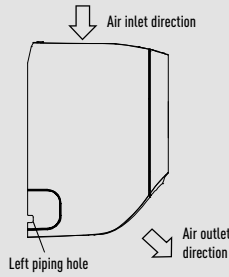

Front view

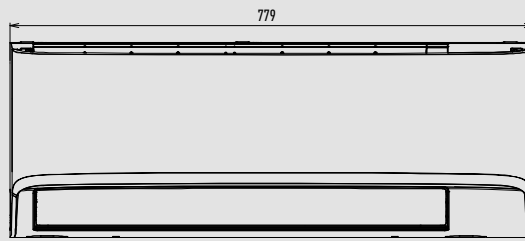

Side view

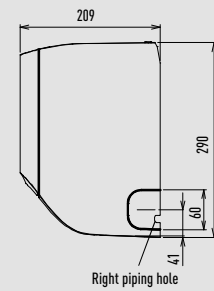

Bottom view

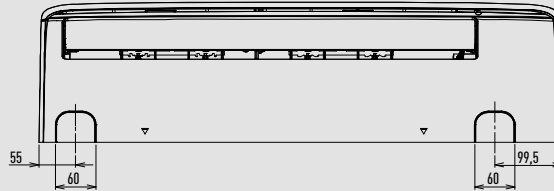

Rear view

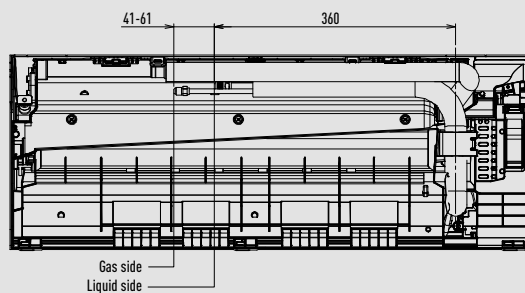

Relative position between the indoor unit and the installation plate

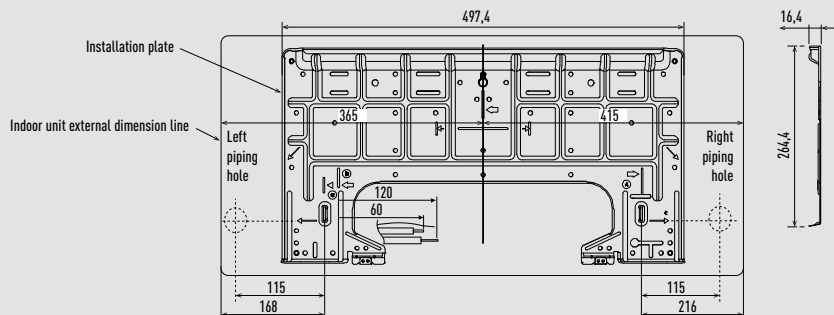

CU-UZ25ZKE / CU-UZ35ZKE

Top view

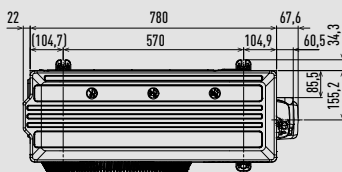

Front view

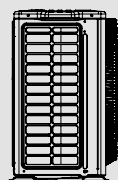

2-way valve at liquid side (high pressure)  
3-way valve at gas side (low pressure)

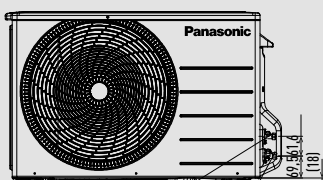

Side view

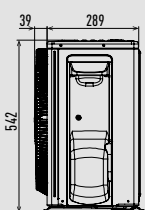

Side view

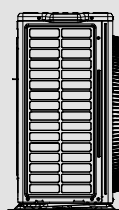

CU-UZ50ZKE

Top view

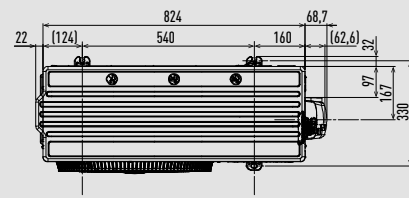

Front view

2-way valve at liquid side (high pressure)  
3-way valve at gas side (low pressure)



Side view

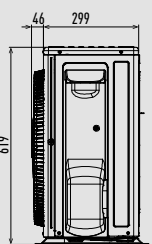

Floor console.

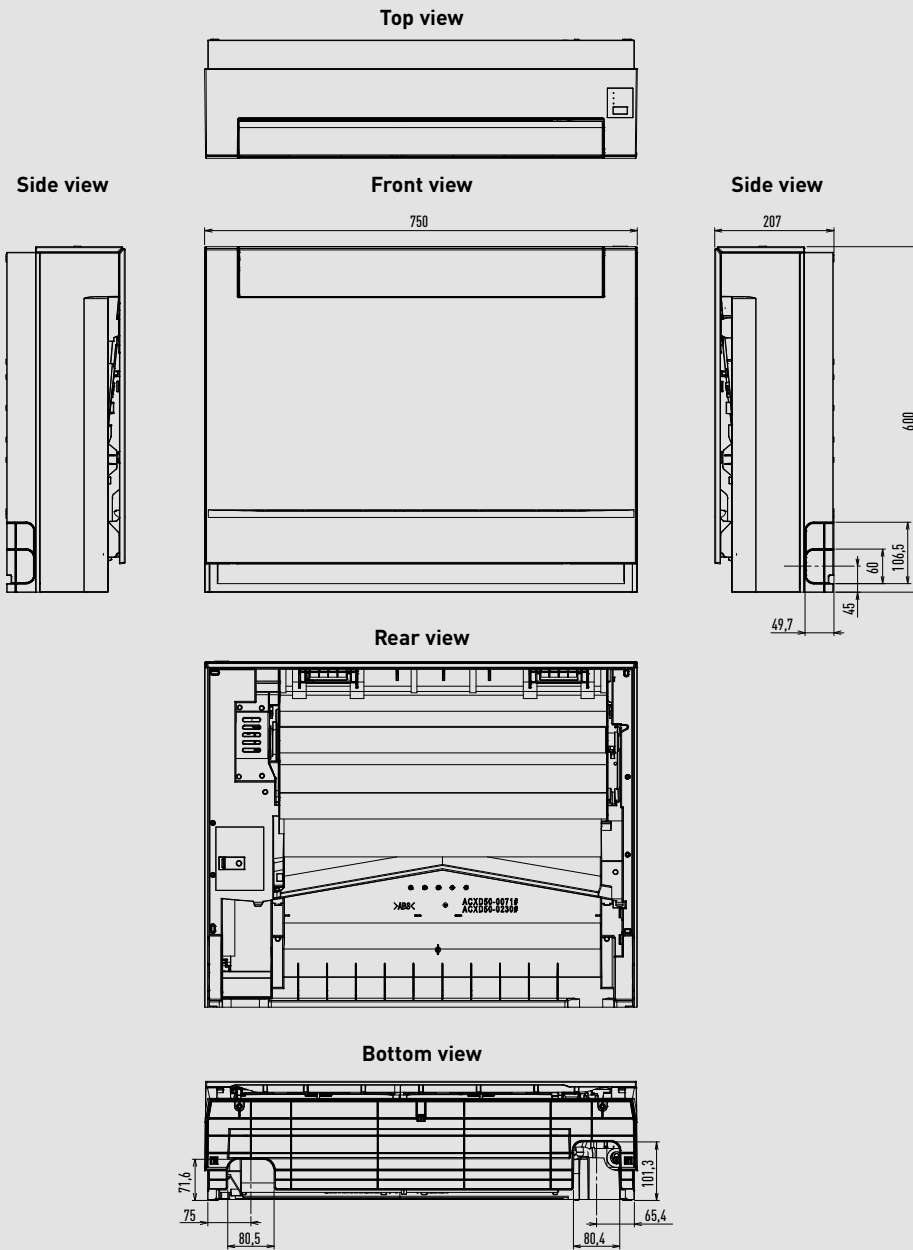

CU-Z25UBEA

CU-Z35UBEA

CU-Z50UBEA

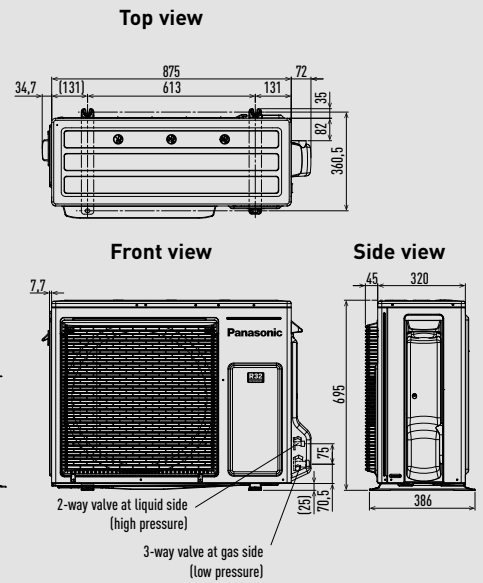
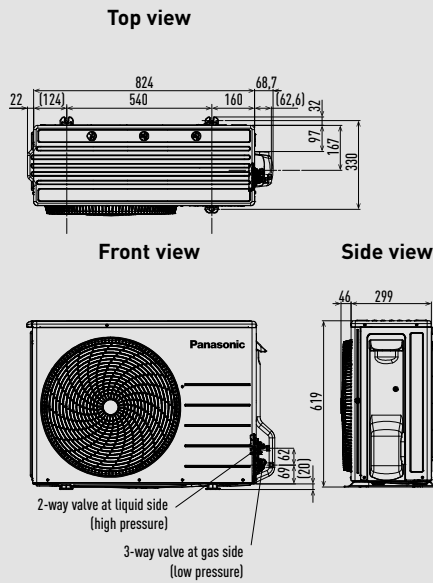
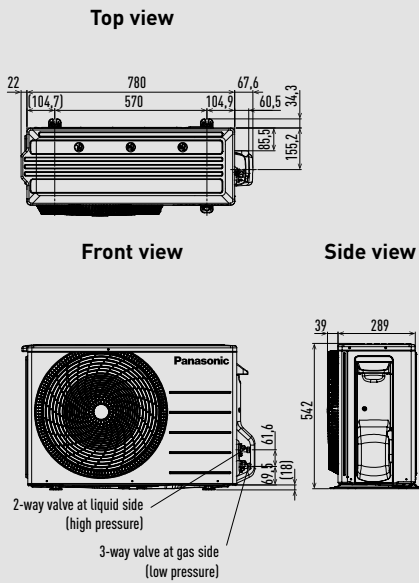

Unit: mm



Low static pressure hide-away.

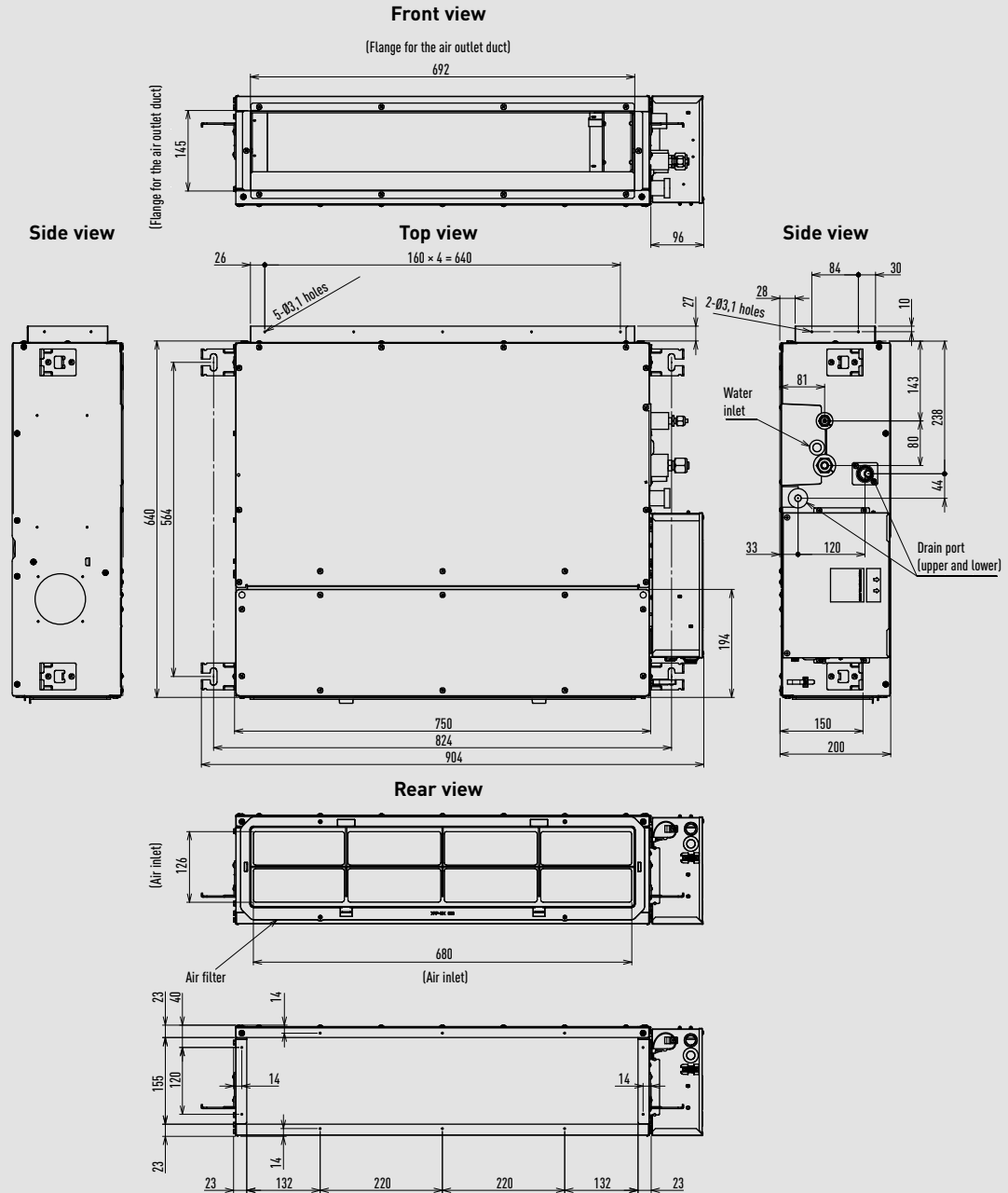

CU-Z25UBEA

Top view

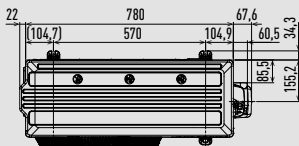

Front view

Side view

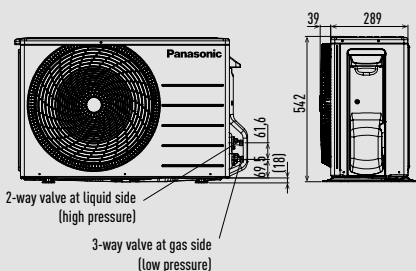

CU-Z35UBEA

Top view

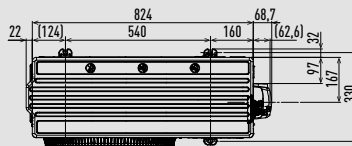

Front view

Side view

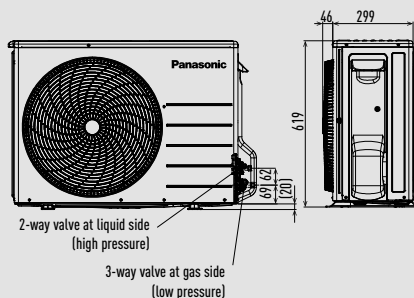

CU-Z50UBEA / CU-Z60UBEA

Top view

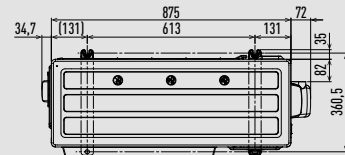

Front view

Side view

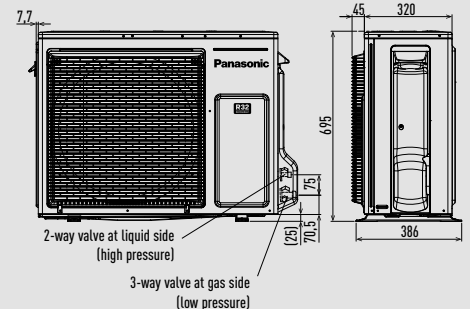

Unit: mm

Indoor unit Multi system Z - 4 Way 60x60 cassette.

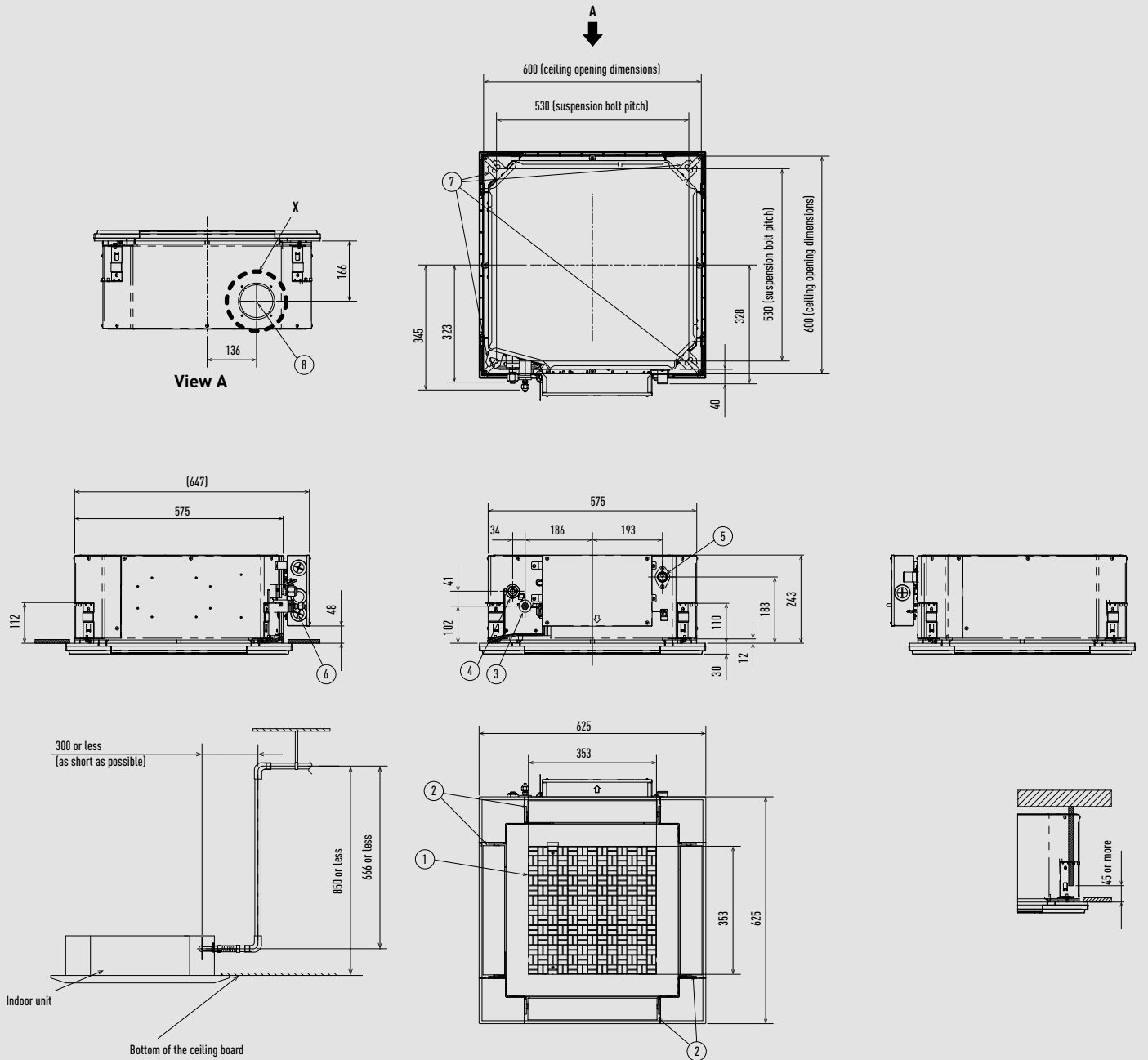

\* Length of supplied drain piping= 250 mm.

Type	20-50	60
1 Air inlet		
2 Air outlet		
3 Refrigerant piping (liquid)	$\varnothing 6,35$ (flared)	$\varnothing 9,52$ (flared)
4 Refrigerant piping (gas)	$\varnothing 12,70$ (flared)	$\varnothing 15,88$ (flared)
5 Drain piping connection port VP20		
6 Power supply port		
7 Suspension bolt hole (4-11x26 slot)		
8 Fresh air inlet duct connection port ( $\varnothing 100$ ) <sup>1)</sup>		

1) Necessary to attach duct connecting flange (field supply).

Filter dimension: 362 x 362 x 15 mm.

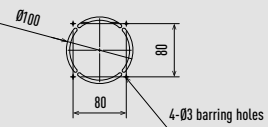

Detailed view X

Outdoor units Multi system Z.

CU-2Z35TBE / CU-2Z41TBE / CU-2Z50TBE

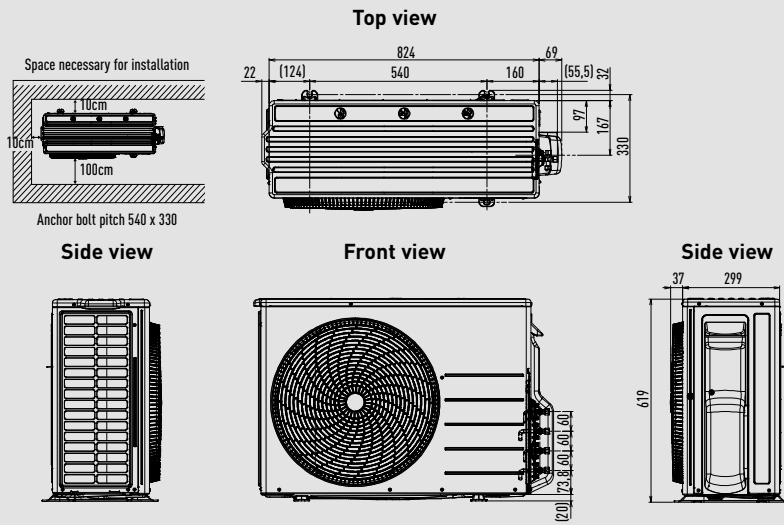

CU-3Z52TBE / CU-3Z68TBE / CU-4Z68TBE

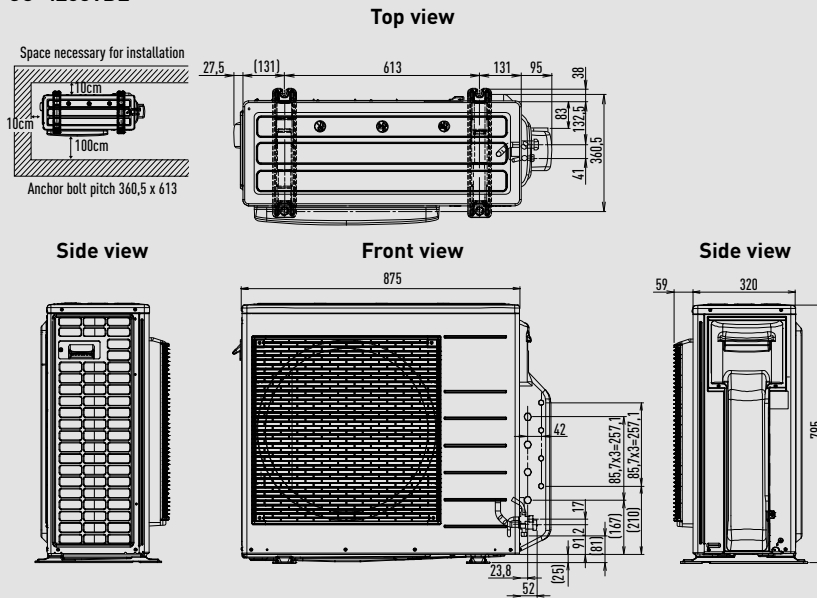

CU-4Z80TBE / CU-5Z90TBE

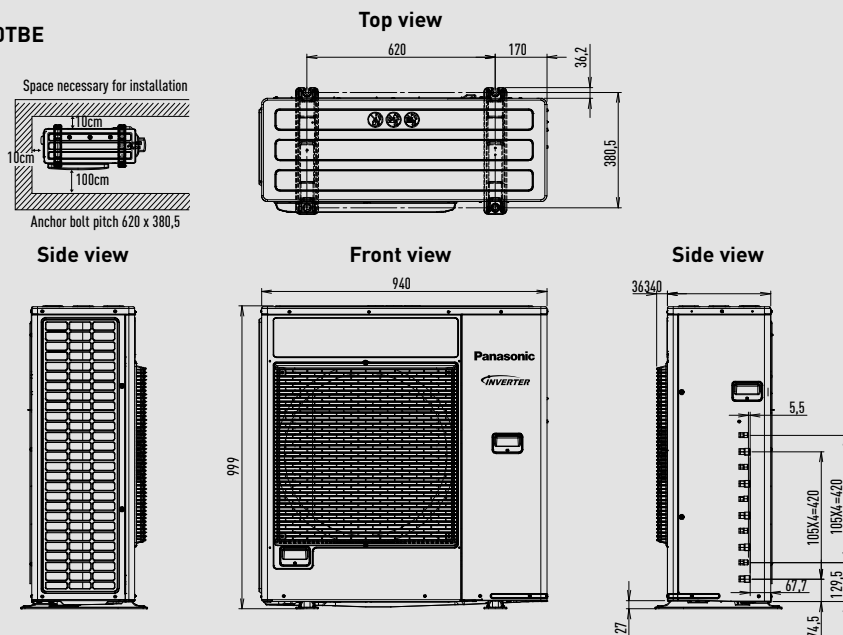

Outdoor units Power Heat Multi system.

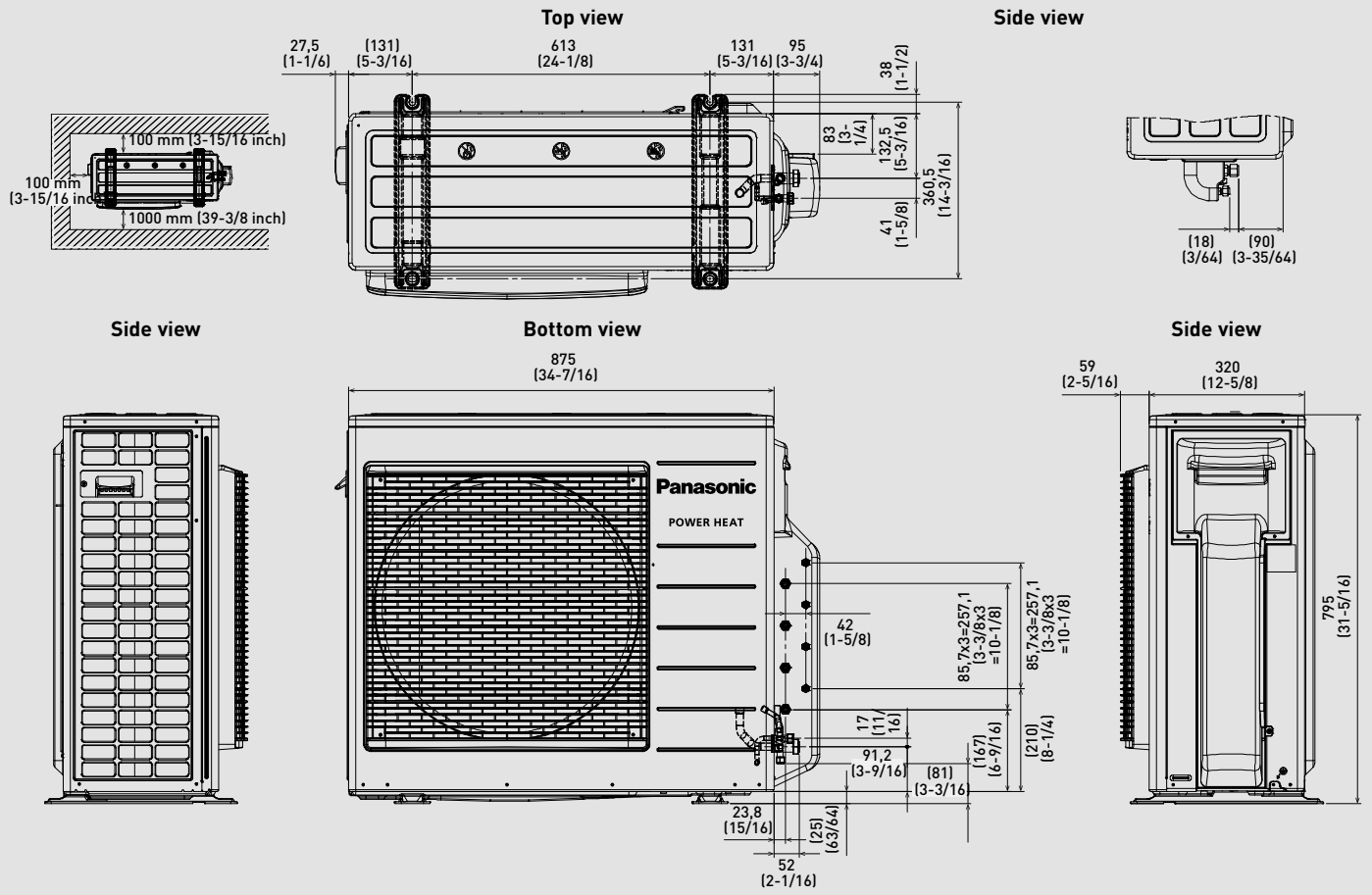

Unit: mm

Outdoor units Multi TZ.

CU-2TZ41TBE / CU-2TZ50TBE

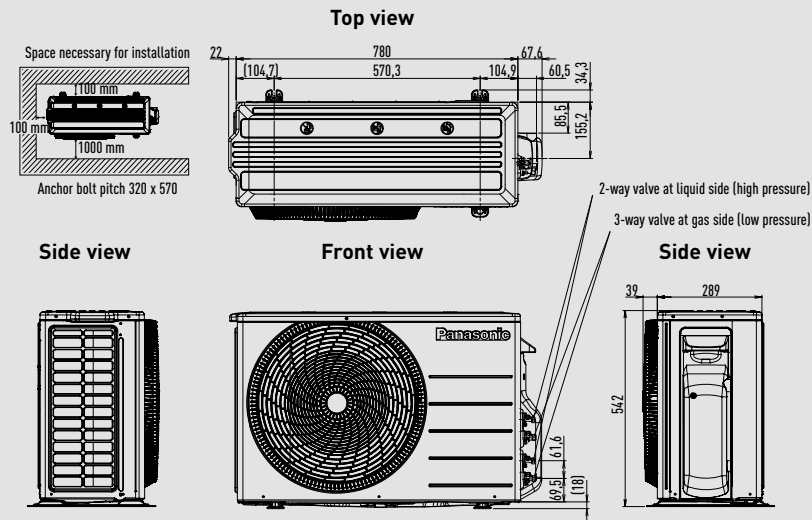

CU-3TZ52TBE

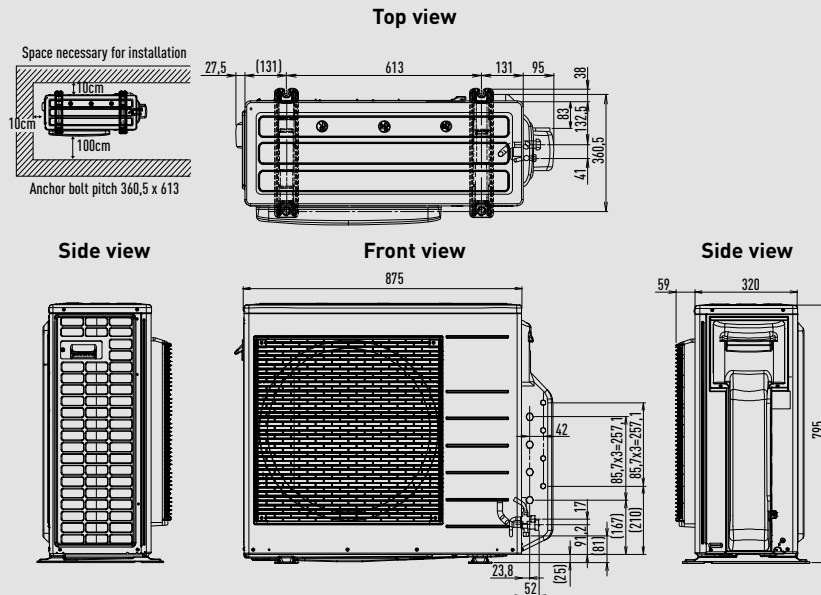

RAC Solo.

P-M0G16IC5-E

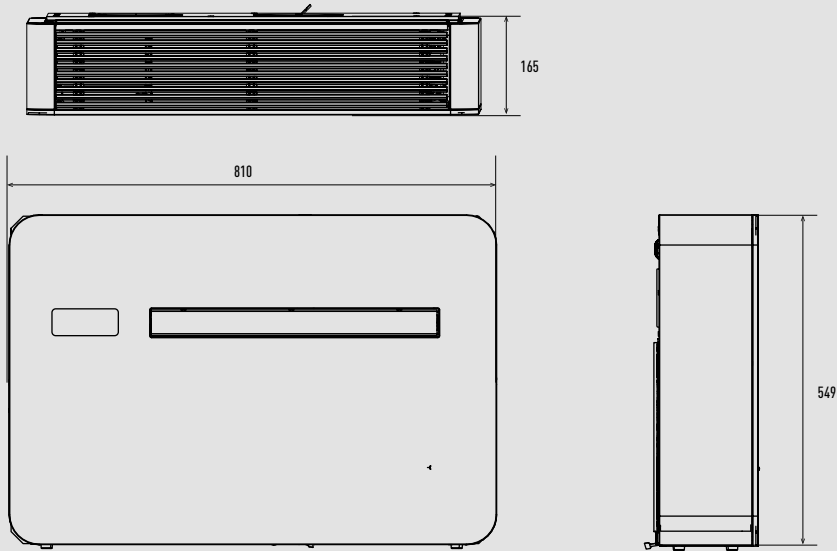

P-MOZ20IC5-E / P-MOZ25IC5-E / P-MOZ30IC5-E

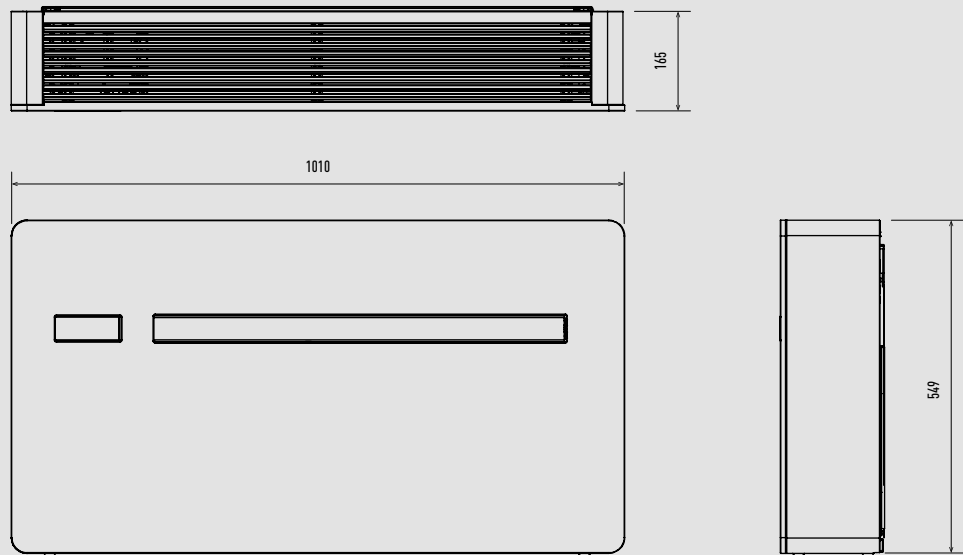

Wall-mounted Professional (from 2,5 to 4,2 kW).

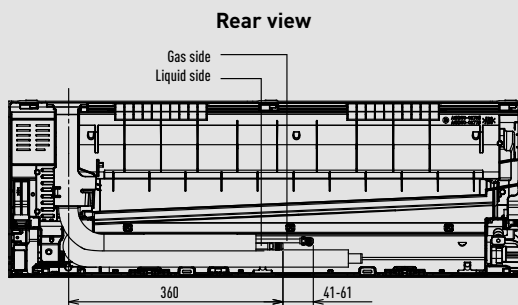
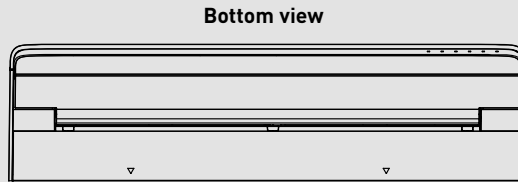
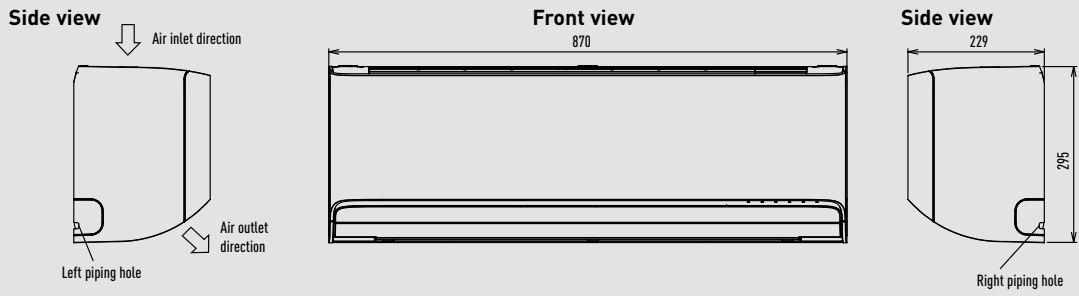

Relative position between the indoor unit and the installation plate

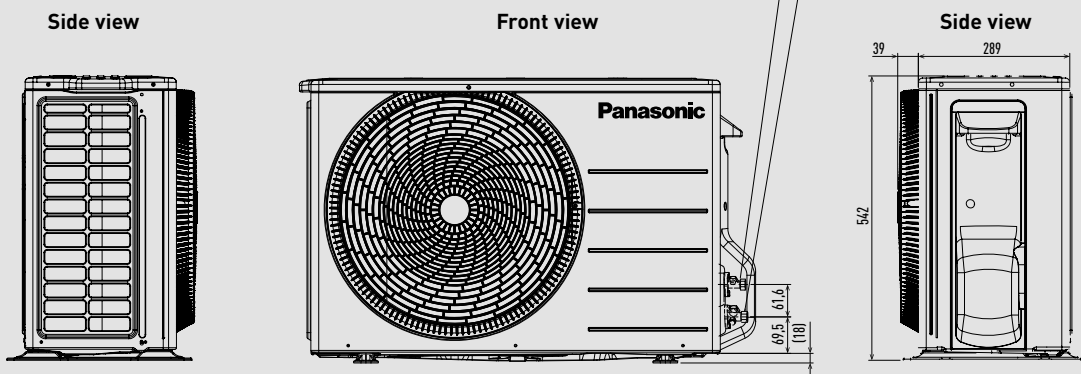
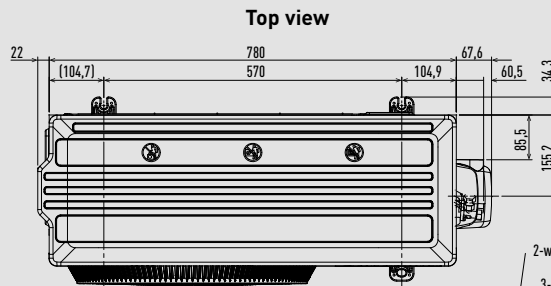
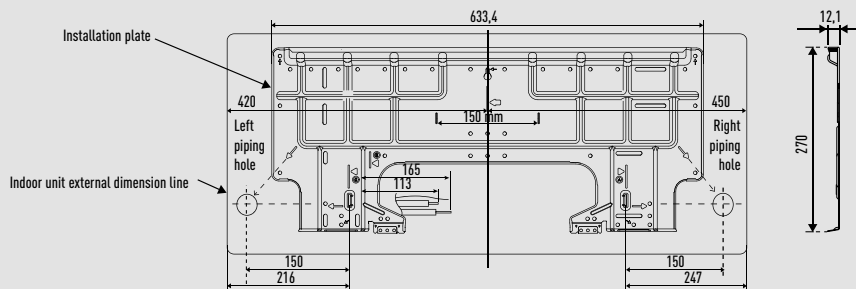

Wall-mounted Professional (5,0 and 7,1 kW).

Side view

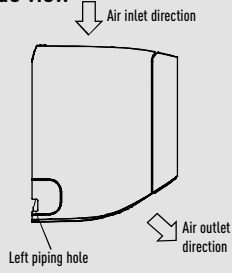

Front view

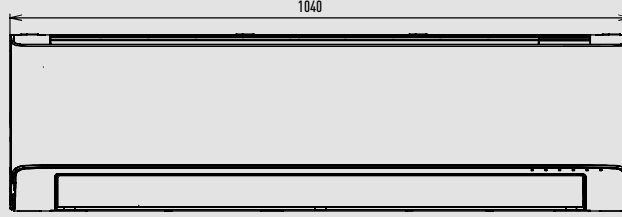

Side view

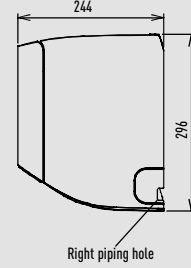

Bottom view

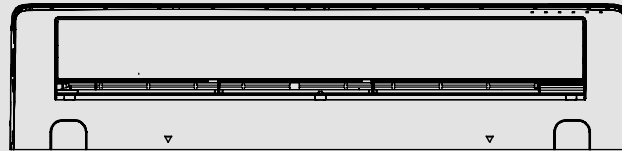

Rear view

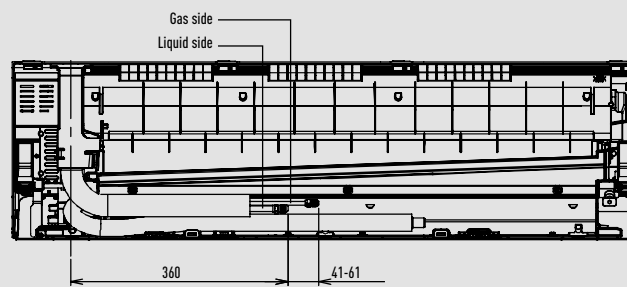

Relative position between the indoor unit and the installation plate

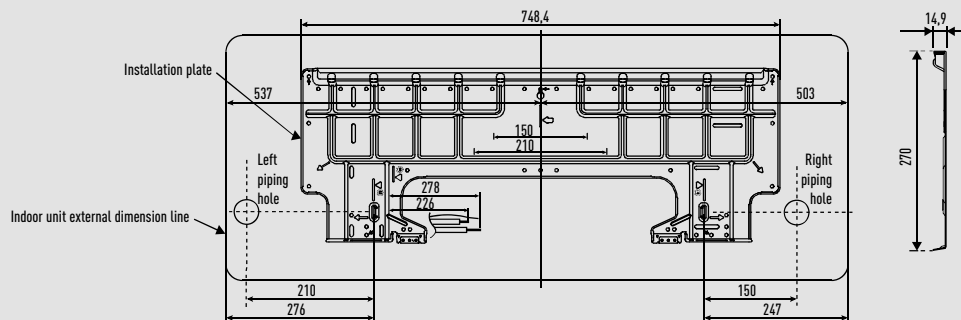

Top view

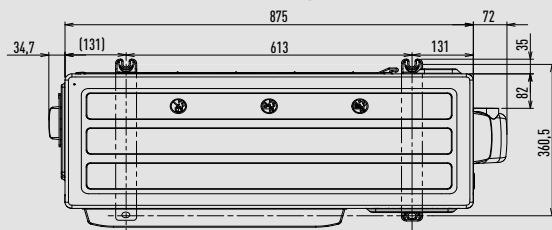

2-way valve at liquid side (high pressure)

3-way valve at gas side (low pressure)

Side view

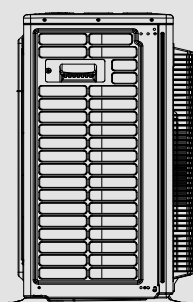

Front view

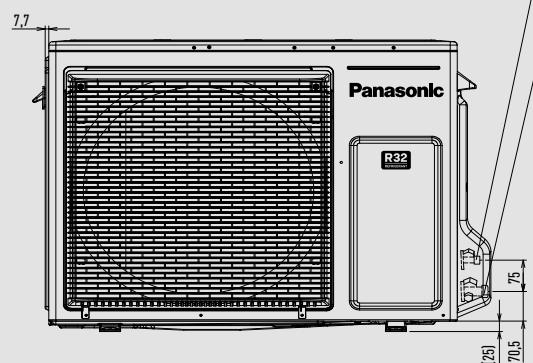

Side view

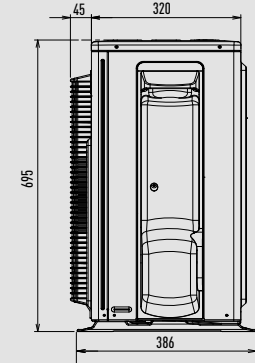

Unit: mm



PACi NX Series wall-mounted.

S-2545PK4E

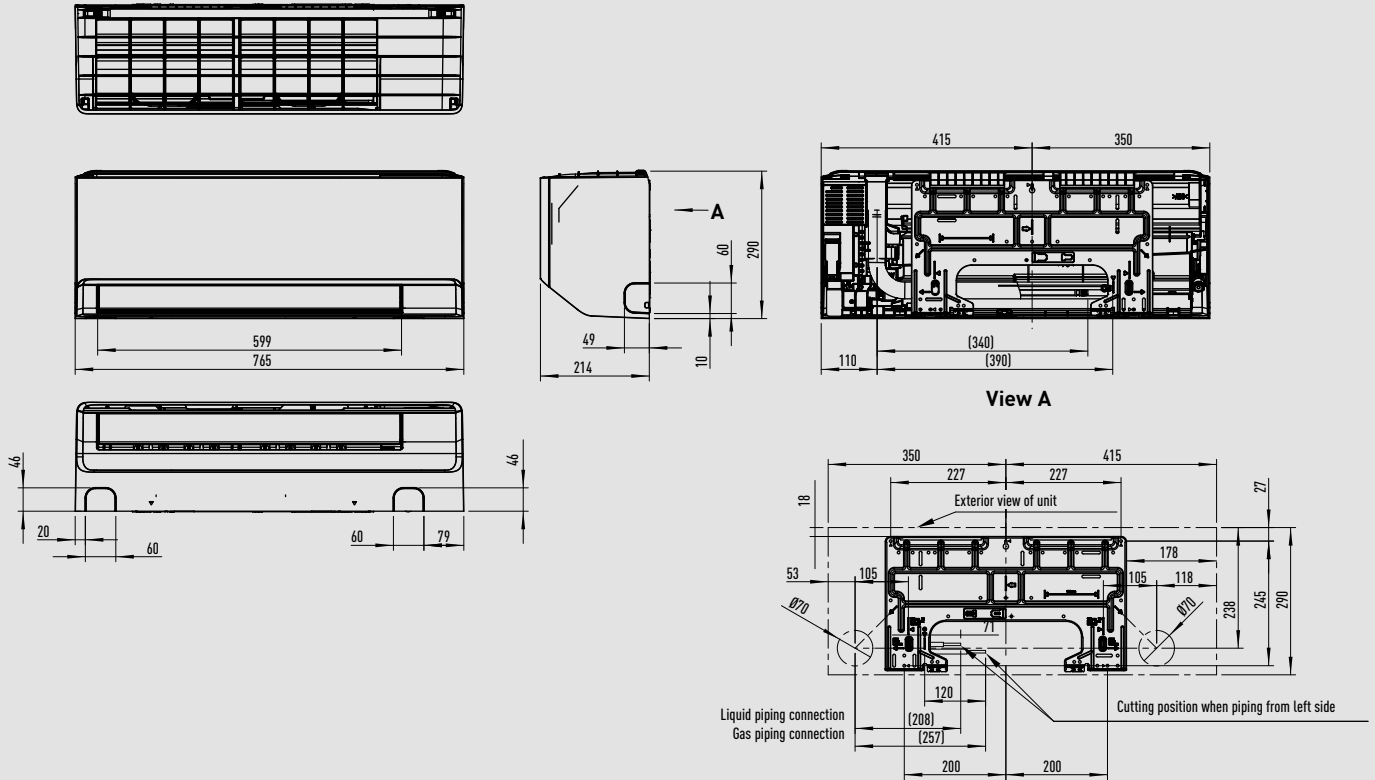

S-5010PK4E

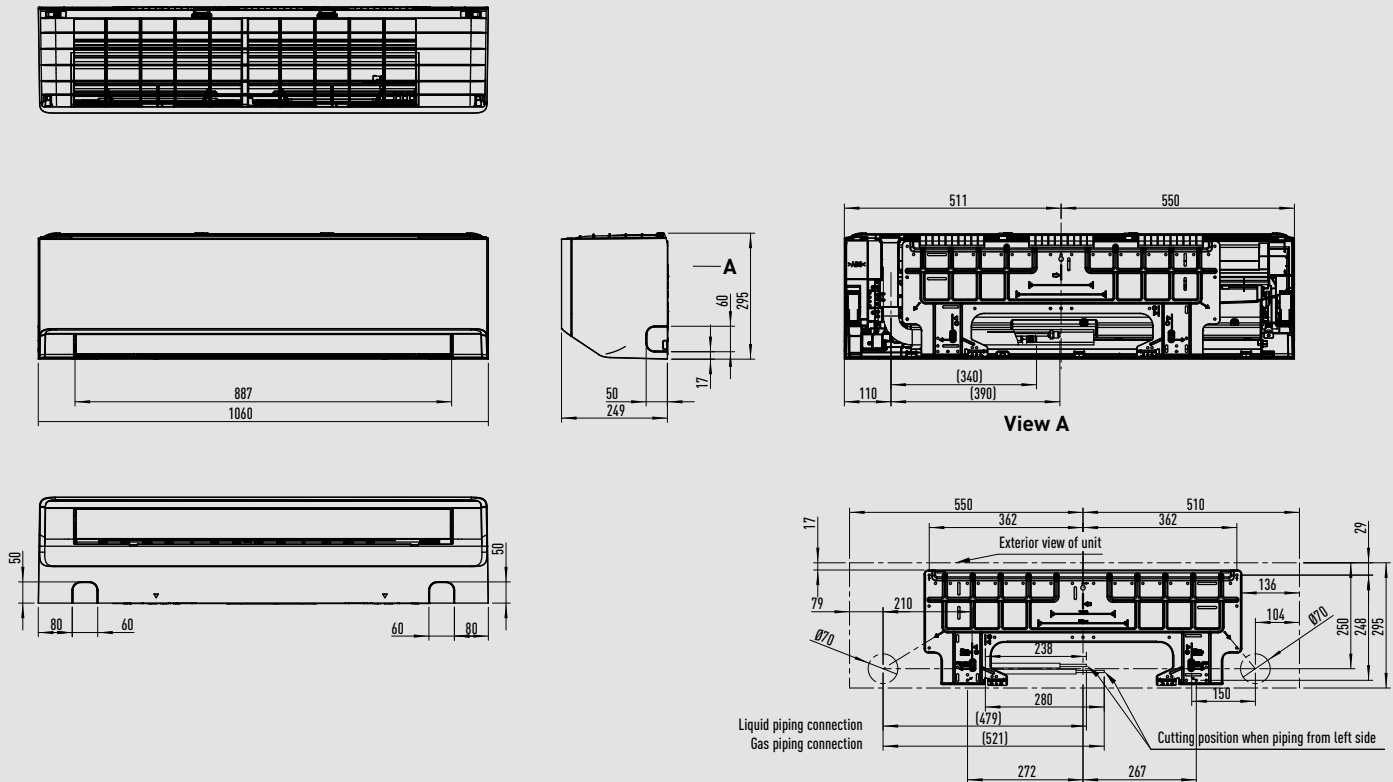

Unit: mm

PACi NX Series 4 way 60x60 cassette.

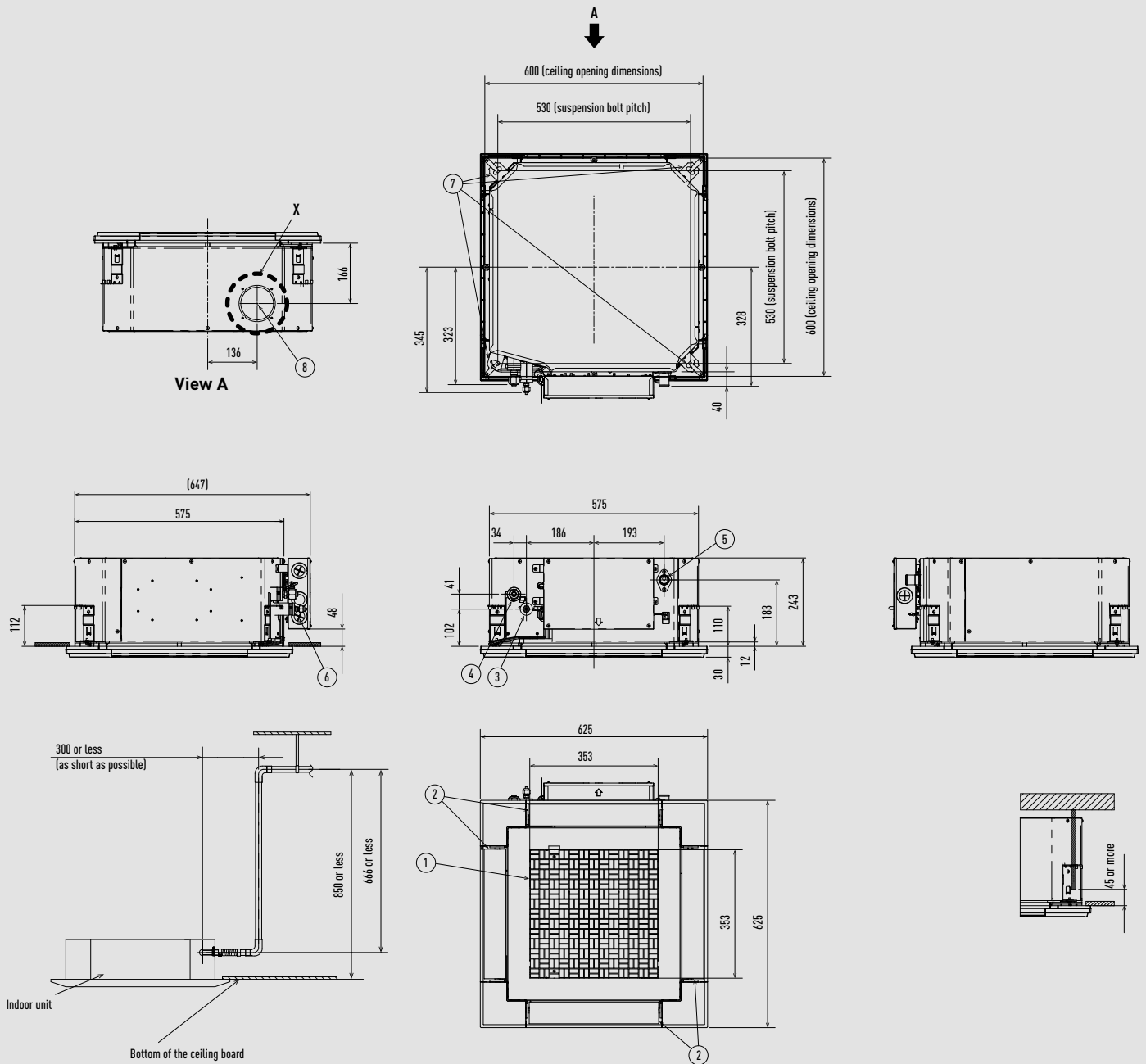

\* Length of supplied drain piping= 250 mm.

Type	25-50	60
1 Air inlet		
2 Air outlet		
3 Refrigerant piping (liquid)	Ø6,35 (flared)	Ø9,52 (flared) <sup>1)</sup>
4 Refrigerant piping (gas)	Ø12,70 (flared)	Ø15,88 (flared) <sup>2)</sup>
5 Drain piping connection port VP20		
6 Power supply port		
7 Suspension bolt hole (4-11x26 slot)		
8 Fresh air inlet duct connection port (Ø100) <sup>3)</sup>		

1) When connecting with U-60PZ3E5A or U-60PZH3E5, connect the liquid socket piping (Ø9,52 - Ø6,35) to the liquid piping side indoor unit.  
 2) When connecting with U-60PZ3E5A or U-60PZH3E5, connect the gas socket piping (Ø15,88 - Ø12,70) to the gas piping side indoor unit.  
 3) Necessary to attach duct connecting flange (field supply).

Filter dimension: 362 x 362 x 15 mm.

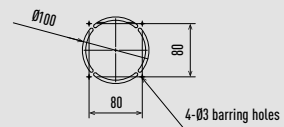

Detailed view X

PACi NX Series 4 way 90x90 cassette.

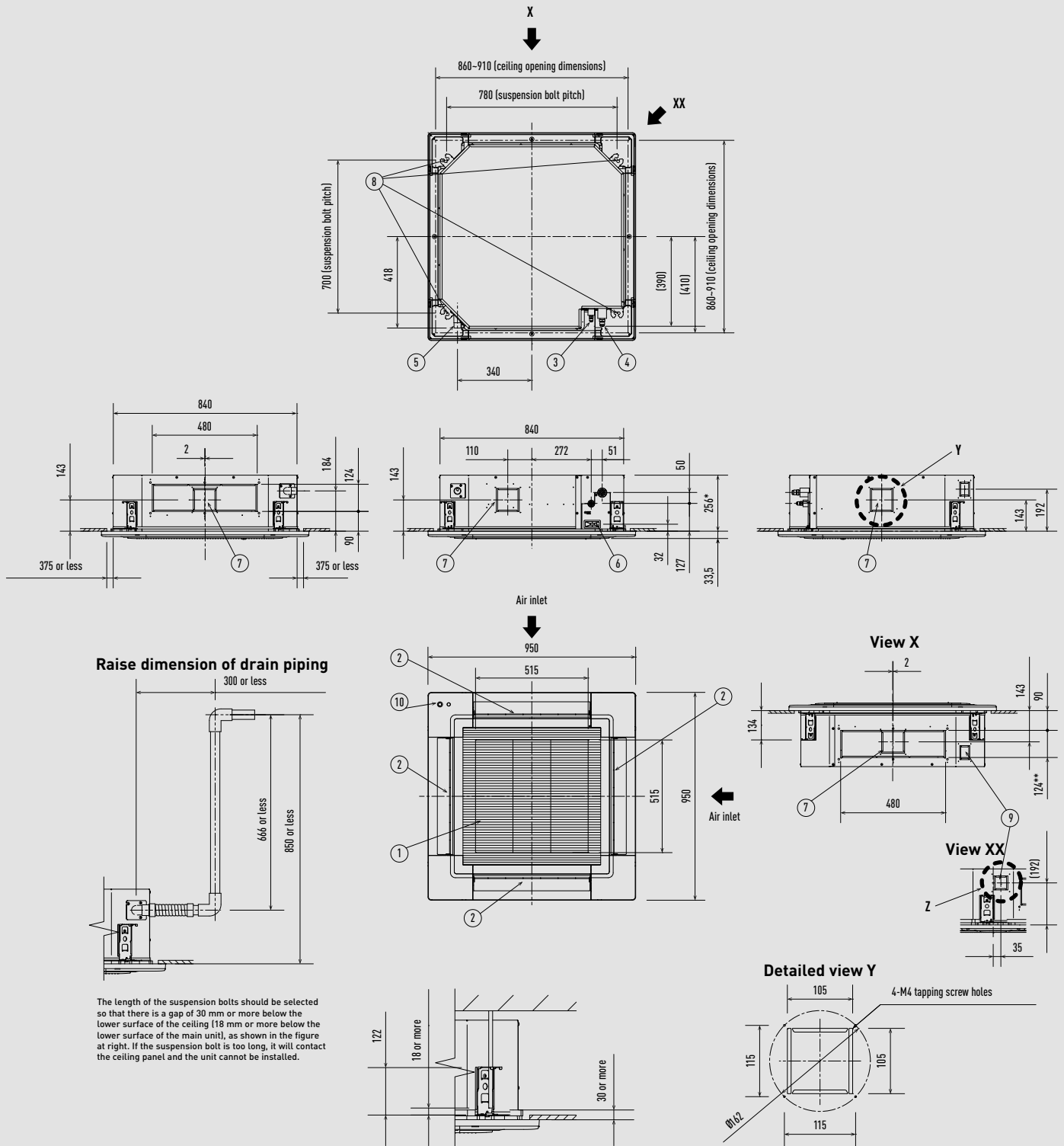

Raise dimension of drain piping

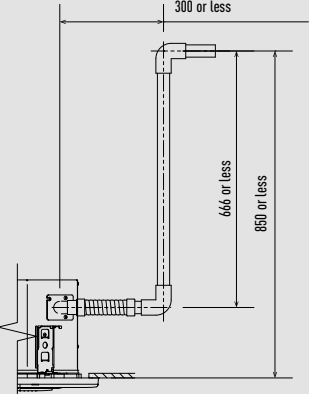

The length of the suspension bolts should be selected so that there is a gap of 30 mm or more below the lower surface of the ceiling (18 mm or more below the lower surface of the main unit), as shown in the figure at right. If the suspension bolt is too long, it will contact the ceiling panel and the unit cannot be installed.

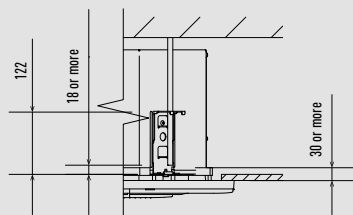

Type	S-3650PU3E	S-6071PU3E	S-1014PU3E
1 Air inlet			
2 Air outlet			
3 Refrigerant piping (liquid)	Ø6,35 (flared)	Ø9,52 (flared) <sup>1)</sup>	Ø9,52 (flared)
4 Refrigerant piping (gas)	Ø12,70 (flared)	60: Ø15,88 (flared) <sup>2)</sup> 71: Ø15,88 (flared)	Ø15,88 (flared)
5 Drain piping connection port VP25		Outer diameter 32 mm	
6 Power supply port			
7 Suspension bolt hole		4-12x30 elongated hole	
8 Fresh air inlet duct connection port		Ø100 <sup>3)</sup>	
9 Suspension bolt hole		4-12x30 elongated hole	
10 Econavi sensor (only CZ-KPU3A or CZ-KPU3AW)			

1) When connecting with U-60PZ3E5, U-71PZ3E5 or U-60PZH3E5, connect the liquid socket piping (Ø9,52 - Ø6,35) to the liquid piping side indoor unit.

2) When connecting with U-60PZ3E5 or U-60PZH3E5, connect the gas socket piping (Ø15,88 - Ø12,70) to the gas piping side indoor unit.

3) Necessary to attach duct connecting flange (field supply).

Filter dimension: 520 x 520 x 15 mm.

\* 319 mm for S-1014PU3E.

\*\* 187 mm for S-1014PU3E.

PACi NX Series ceiling (S-3650PT3E).

Detailed view of air inlet duct connection port

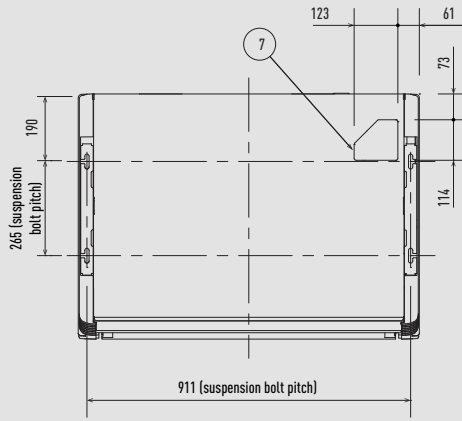
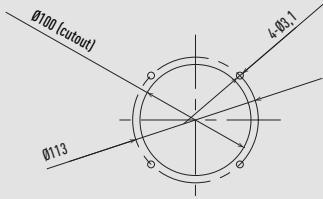

Distance of each exposed bolt must be of equal length within 50 mm

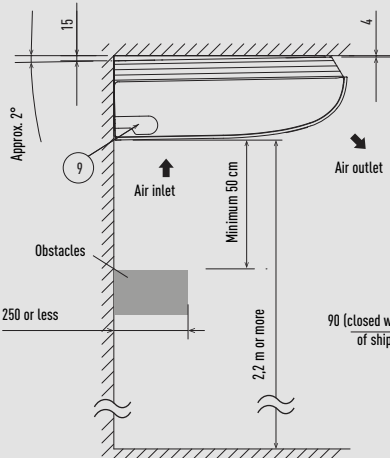
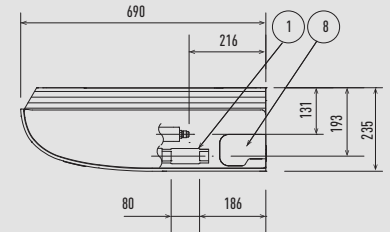
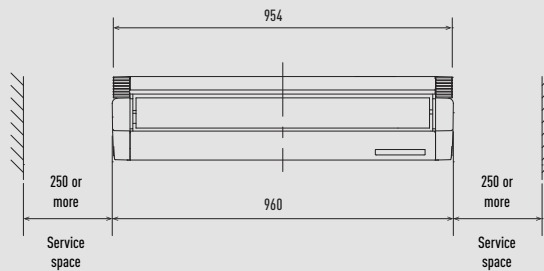
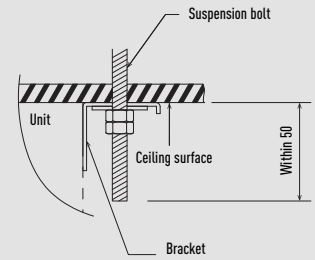

Side view

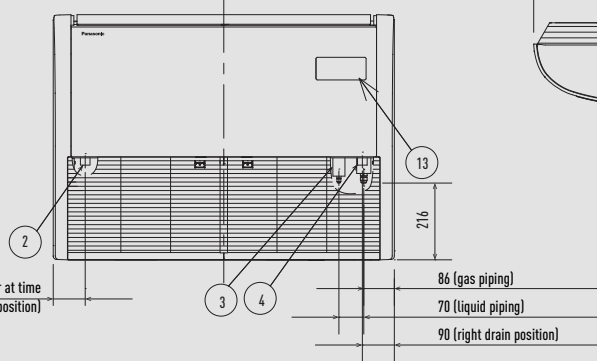

Hole position of indoor unit rear-side (figure shows view from front)

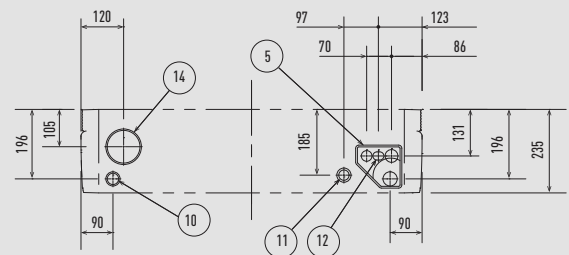

Piping hole position on wall surface (figure shows view from front)

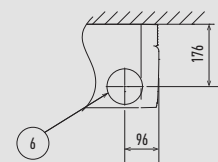

1	Drain piping connection port VP20	Inside diameter 26 mm, drain hose supplied
2	Left drain position	
3	Refrigerant piping (liquid)	Ø6,35mm (flared)
4	Refrigerant piping (gas)	Ø12,7mm (flared)
5	Cover of rear piping hole	
6	Piping hole on wall surface	Ø100 mm
7	Upper side piping port	
8	Right side drain hose outlet port (cutout)	
9	Left side drain hose outlet port (cutout)	
10	Left-rear side drain hose outlet port (cutout)	
11	Power inlet port	
12	Remote control wiring and inter-unit wiring inlet port	
13	Wireless remote controller receiver installation location	
14	Air inlet duct connection port	Ø100 mm (cutout)

Filter dimension: 421 x 250 x 16 mm x 2 pcs.

Unit: mm

PACi NX Series ceiling (S-6071PT3E).

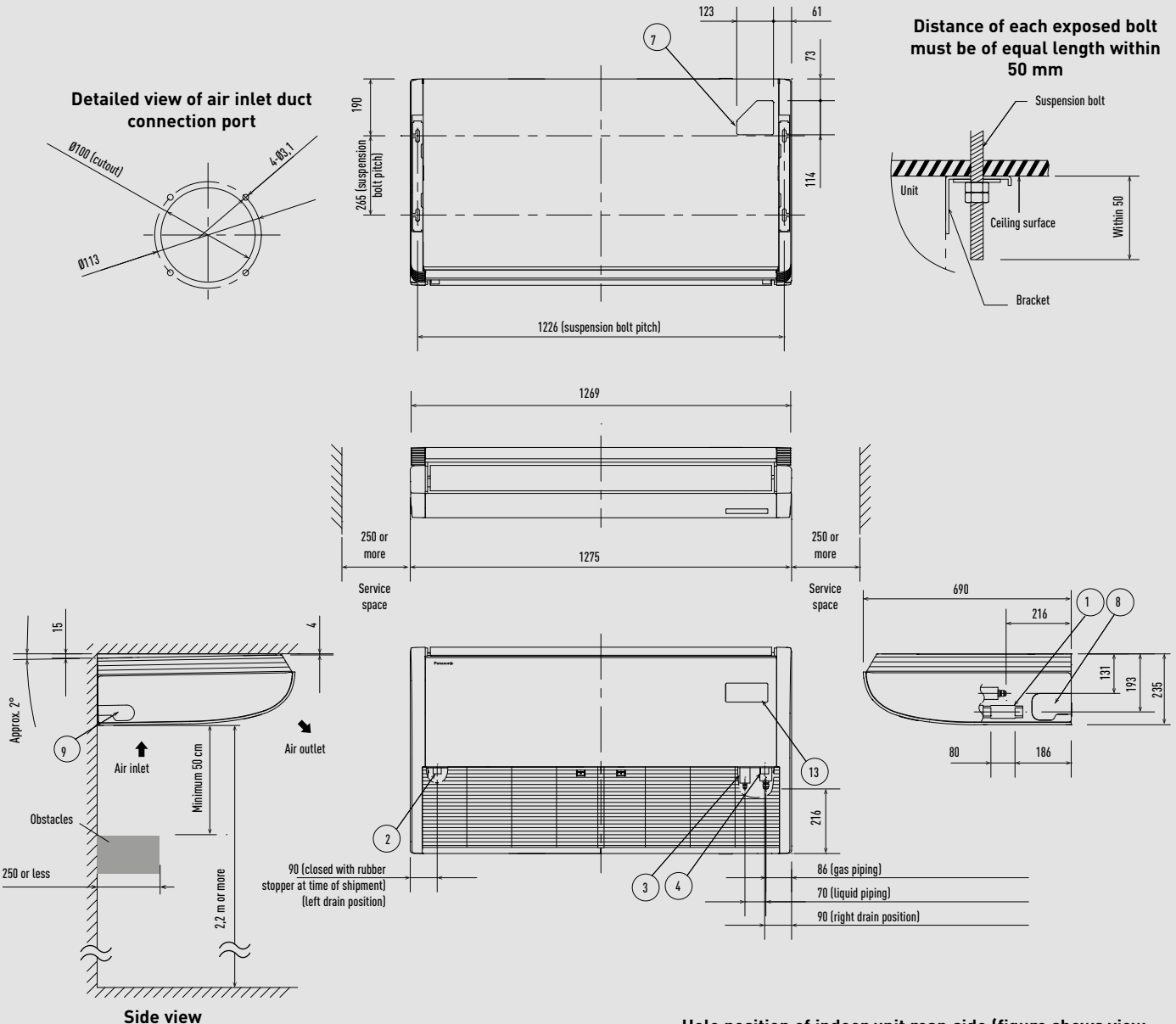

Distance of each exposed bolt must be of equal length within 50 mm

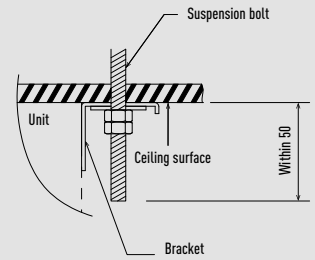

Hole position of indoor unit rear-side (figure shows view from front)

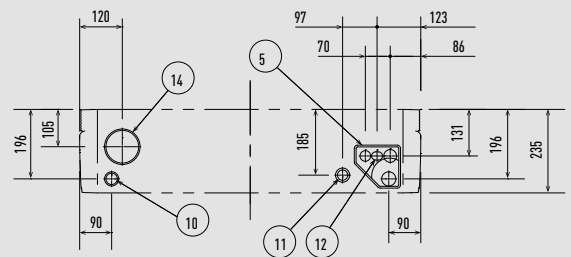

Piping hole position on wall surface (figure shows view from front)

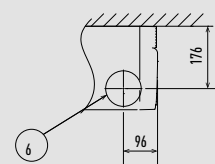

1	Drain piping connection port VP20	Inside diameter 26 mm, drain hose supplied
2	Left drain position	
3	Refrigerant piping (liquid)	Ø9,52 (flared) <sup>1)</sup>
4	Refrigerant piping (gas)	Ø15,88 (flared) <sup>2)</sup>
5	Cover of rear piping hole	
6	Piping hole on wall surface	Ø100 mm
7	Upper side piping port	
8	Right side drain hose outlet port (cutout)	
9	Left side drain hose outlet port (cutout)	
10	Left-rear side drain hose outlet port (cutout)	
11	Power inlet port	
12	Remote control wiring and inter-unit wiring inlet port	
13	Wireless remote controller receiver installation location	
14	Air inlet duct connection port	Ø100 mm (cutout)

1) When connecting with U-60PZ3E5, U-71PZ3E5 or U-60PZH3E5, connect the liquid socket piping (Ø9,52 - Ø6,35) to the liquid piping side indoor unit.  
 2) When connecting with U-60PZ3E5 or U-60PZH3E5, connect the gas socket piping (Ø15,88 - Ø12,70) to the gas piping side indoor unit.

Filter dimension: 579 x 250 x 16 mm x 2 pcs.

Unit: mm

PACi NX Series ceiling (S-1014PT3E).

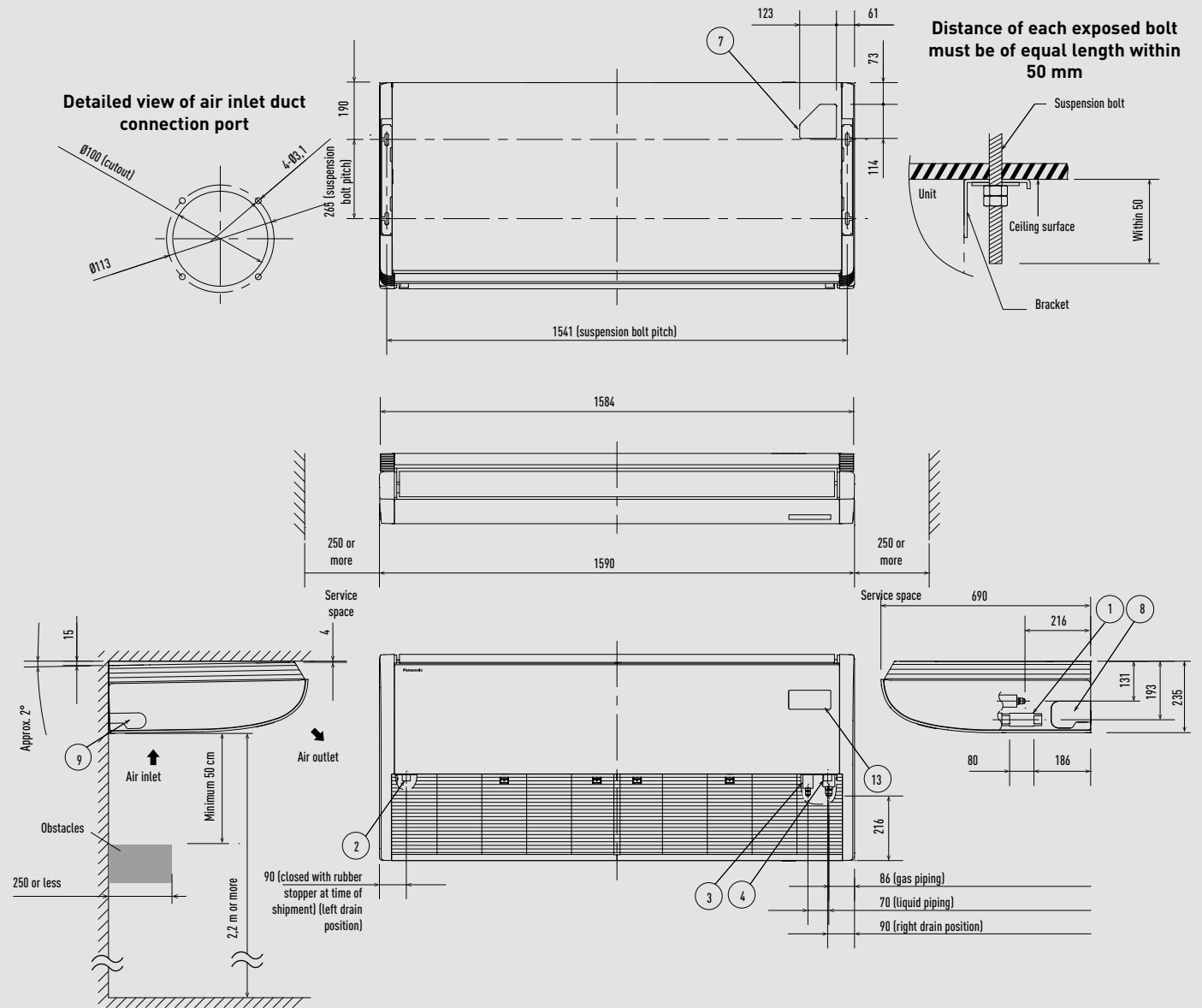

Hole position of indoor unit rear-side (figure shows view from front)

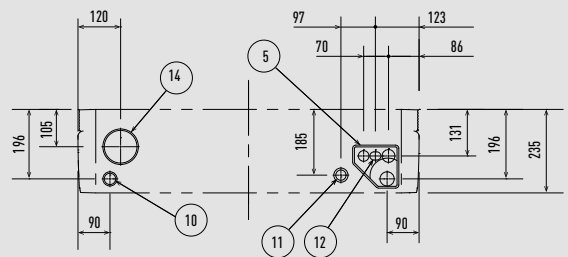

Piping hole position on wall surface (figure shows view from front)

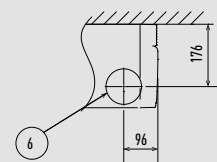

1	Drain piping connection port VP20	Inside diameter 26 mm, drain hose supplied
2	Left drain position	
3	Refrigerant piping (liquid)	Ø9,52 (flared)
4	Refrigerant piping (gas)	Ø15,88 (flared)
5	Cover of rear piping hole	
6	Piping hole on wall surface	Ø100 mm
7	Upper side piping port	
8	Right side drain hose outlet port (cutout)	
9	Left side drain hose outlet port (cutout)	
10	Left-rear side drain hose outlet port (cutout)	
11	Power inlet port	
12	Remote control wiring and inter-unit wiring inlet port	
13	Wireless remote controller receiver installation location	
14	Air inlet duct connection port	Ø100 mm (cutout)

Filter dimension: 736 x 250 x 16 mm x 2 pcs.

PACi NX Series adaptive ducted unit.

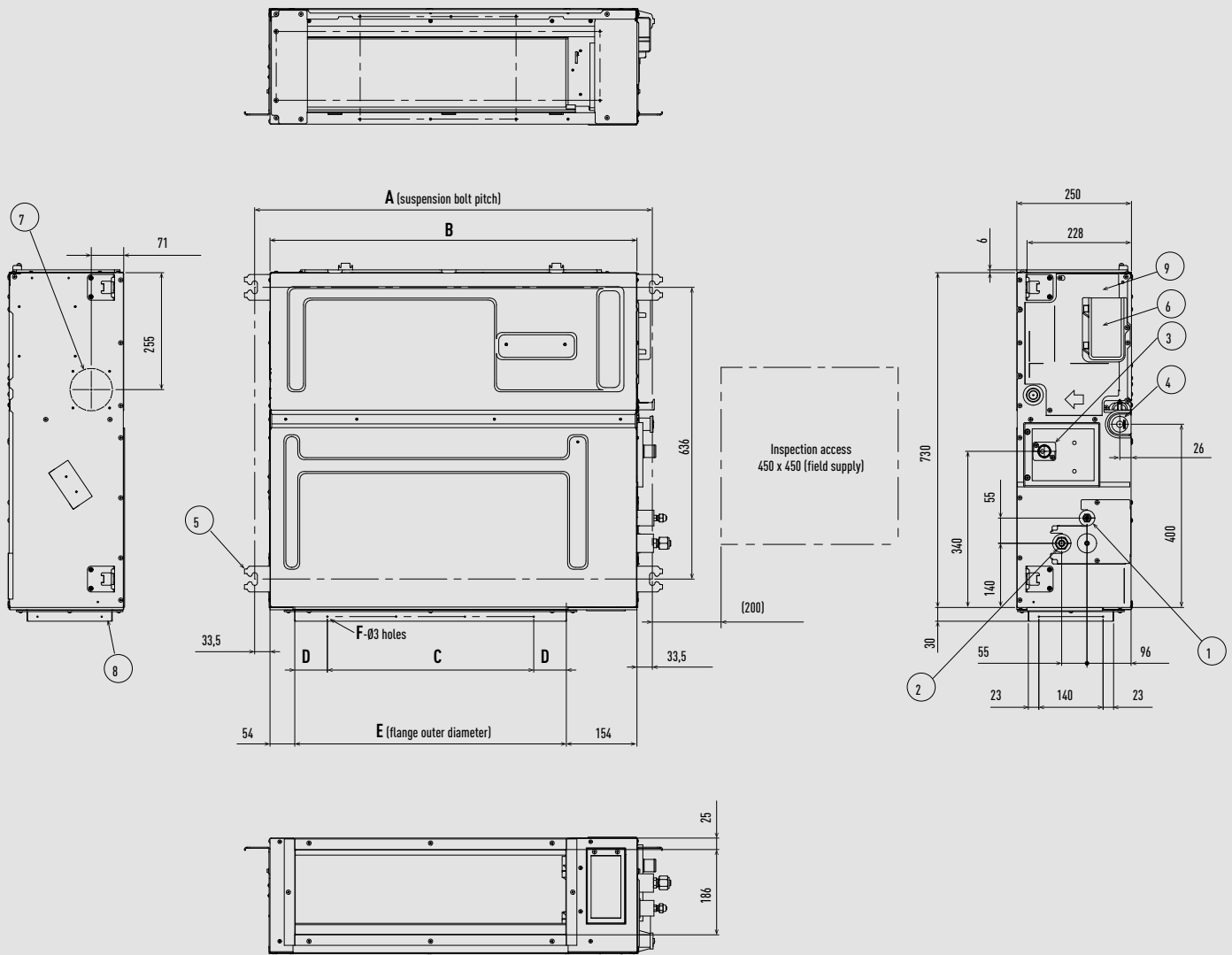

Type	A	B	C	D	E	F
	mm	mm	mm	mm	mm	Q'ty
S-3650PF3E	867	800	450 (pitch 150 x 3)	71	592	12
S-6071PF3E	1067	1000	750 (pitch 150 x 5)	21	792	16
S-1014PF3E	1467	1400	1050 (pitch 150 x 7)	71	1192	20

Type	S-3650PF3E	S-6071PF3E	S-1014PF3E
1 Refrigerant piping (liquid)	Ø6,35 (flared)	Ø9,52 (flared) <sup>1)</sup>	Ø9,52 (flared)
2 Refrigerant piping (gas)	Ø12,70 (flared)	60: Ø15,88 (flared) <sup>2)</sup> , 71: Ø15,88 (flared)	Ø15,88 (flared)
3 Upper drain piping connection port VP20	Outer diameter 26 mm, 200 mm flexible hose supplied		
4 Suspension lug	4-12x30		
5 Power supply port			
6 Bottom drain piping connection port VP20	Ø26 mm		
7 Fresh air inlet duct connection port	Ø100 <sup>3)</sup>		
8 Flange for flexible air outlet duct			
9 Electrical component box			

1) When connecting with U-60PZ3E5, U-71PZ3E5 or U-60PZH3E5, connect the liquid socket piping (Ø9,52 - Ø6,35) to the liquid piping side indoor unit.

2) When connecting with U-60PZ3E5 or U-60PZH3E5, connect the gas socket piping (Ø15,88 - Ø12,70) to the gas piping side indoor unit.

3) Necessary to attach duct connecting flange (field supply).

Filter dimension: 520 x 520 x 15 mm.

Big PACi NX high static pressure hide-away 20,0-25,0 kW.

- |   |   |
|---|---|
| 1 | Refrigerant piping (liquid) Ø12,70 (flared) |
| 2 | Refrigerant piping (gas) Ø22,22 (brazed)    |
| 3 | Power supply port                           |
| 4 | Communication wiring port                   |
| 5 | Drain piping connection port VP25           |
| 6 | Flange for air inlet duct                   |
| 7 | Flange for the air outlet duct              |

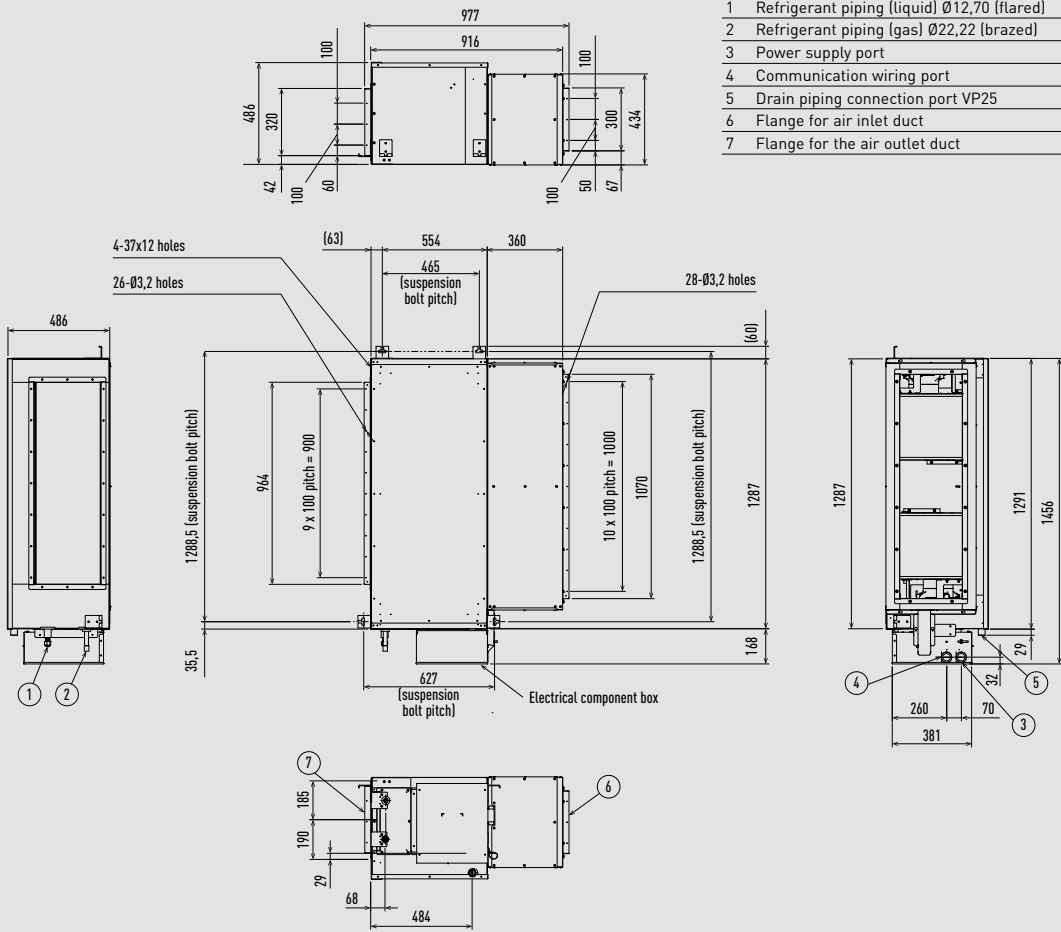

**Dimensions of suspension bolt pitch and unit.  
Required minimum space for installation and service**

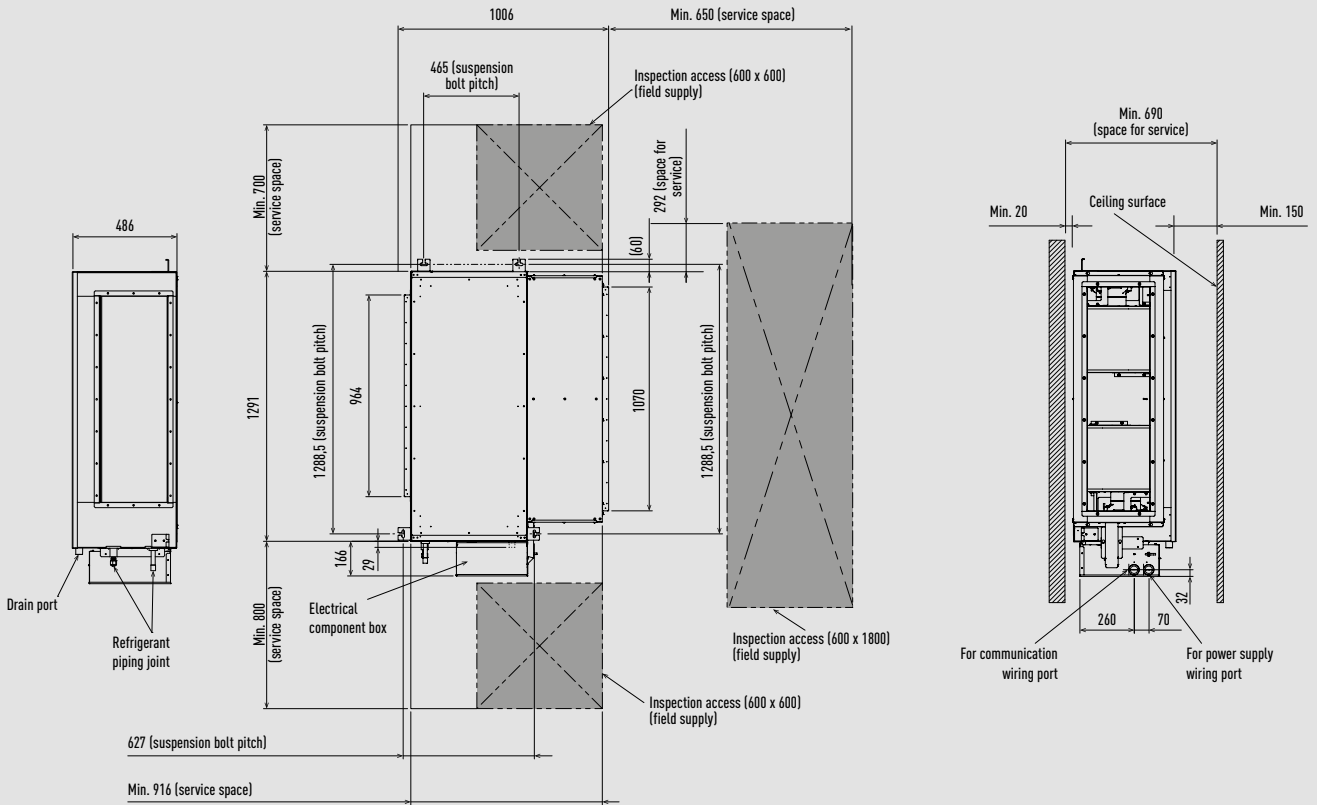



Jet Air Stream - P-VTVF140MC5-PE.

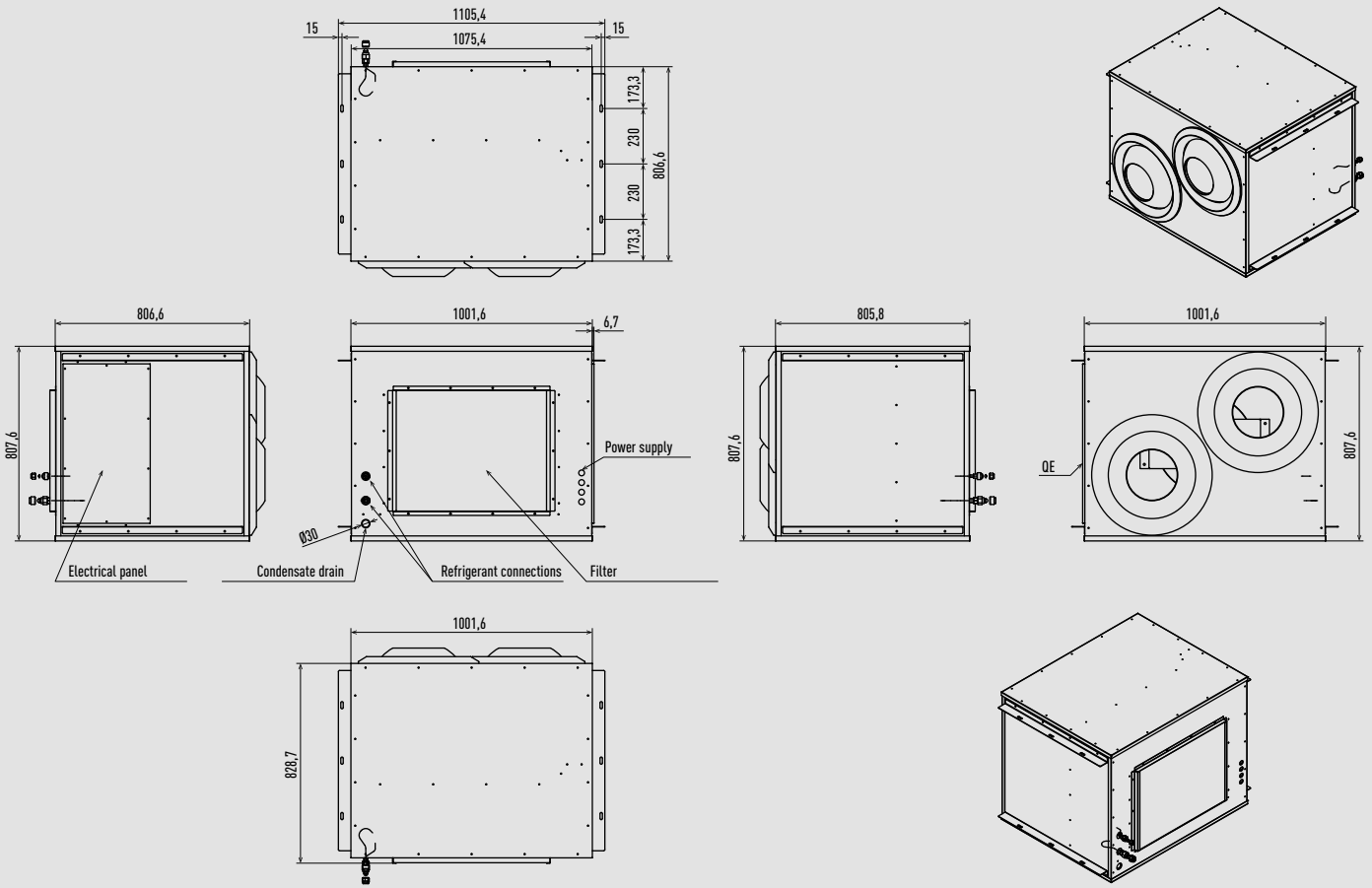

Unit: mm

Jet Air Stream - P-VTVF250MC5-PE.

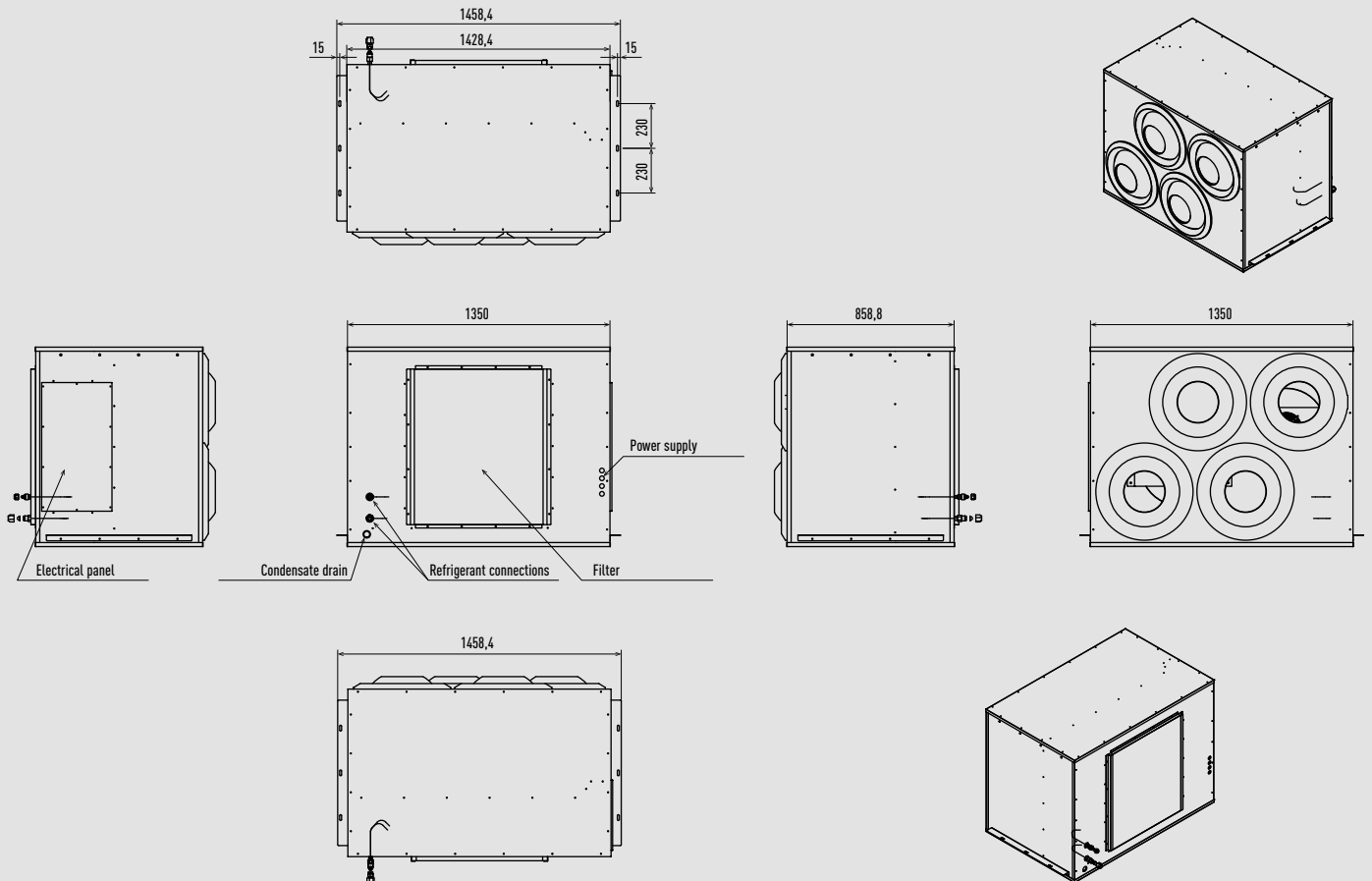

Unit: mm

PACi NX Series Elite outdoor units from 3,6 to 6,0 kW and Standard 6,0 and 7,1 kW.

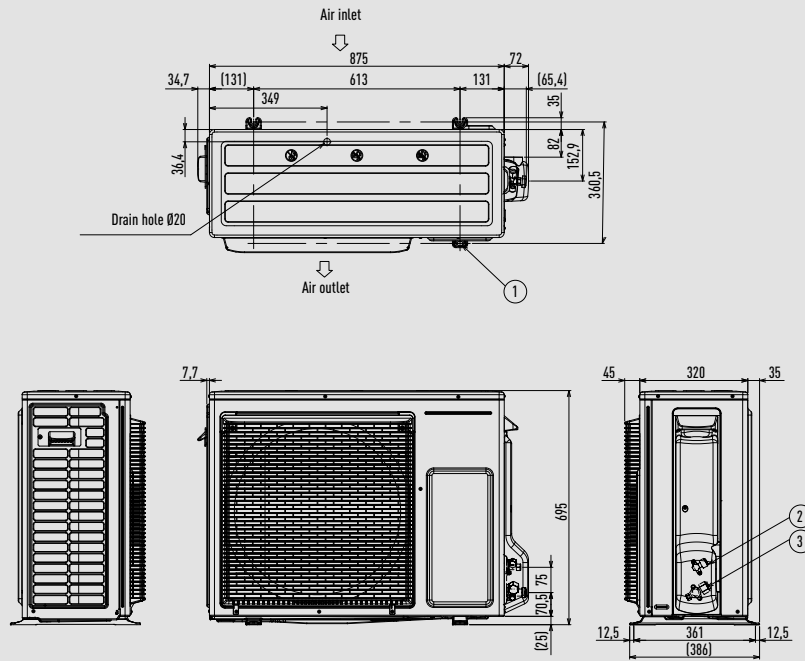

- 1 Mounting hole (4-R6,5), anchor bolt: M10
- 2 Refrigerant piping (liquid), Ø6,35 (flared)
- 3 Refrigerant piping (gas), Ø12,70 (flared). U-71PZ3E5, Ø15,88 (flared)

Unit: mm

PACi NX Series Elite outdoor units from 7,1 kW to 14,0 kW and Standard from 10,0 to 14,0 kW.

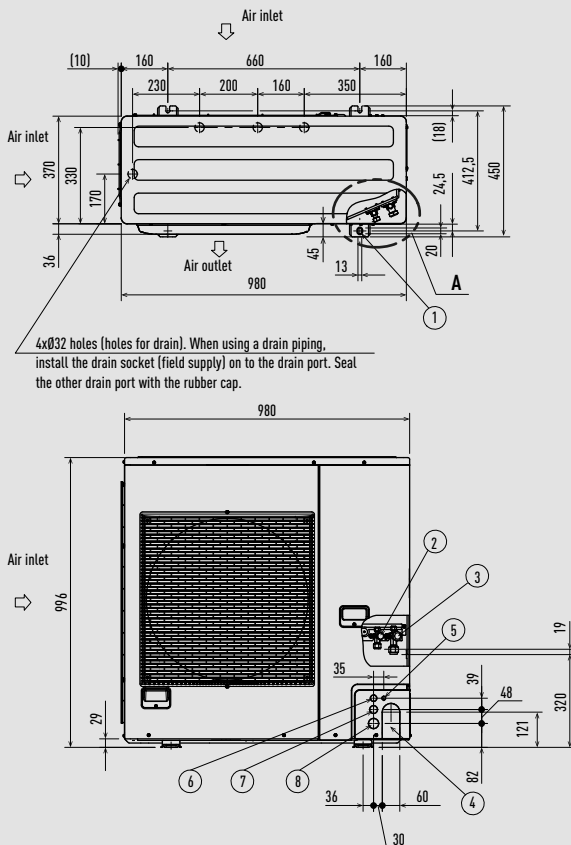

- 1 Mounting hole, anchor bolt: M10
- 2 Refrigerant piping (liquid), Ø9,52 (flared)
- 3 Refrigerant piping (gas), Ø15,88 (flared)
- 4 Refrigerant piping port
- 5 Electrical wiring port (Ø13)
- 6 Electrical wiring port (ØØ22)
- 7 Electrical wiring port (Ø27)
- 8 Electrical wiring port (Ø35)

4xØ32 holes (holes for drain). When using a drain piping, install the drain socket (field supply) on to the drain port. Seal the other drain port with the rubber cap.

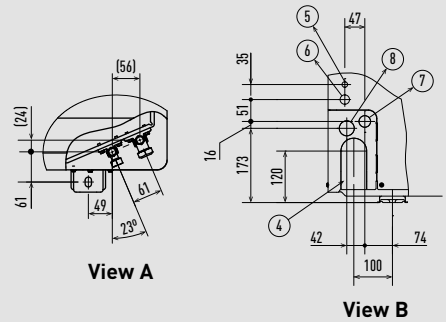

Unit: mm



PACi Water Heat Exchanger.

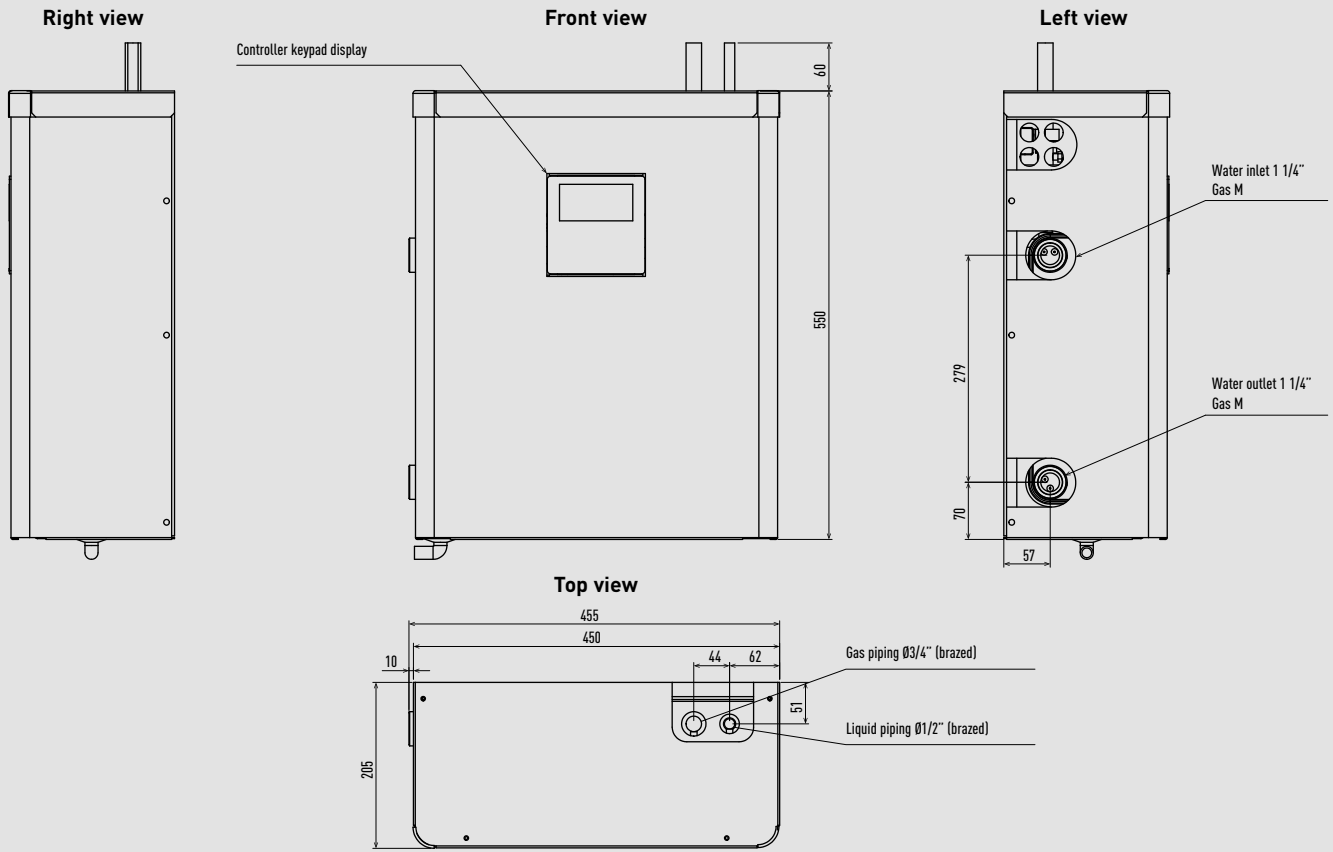

Unit: mm

Mini ECOi LZ2 Series from 4 to 6 HP.

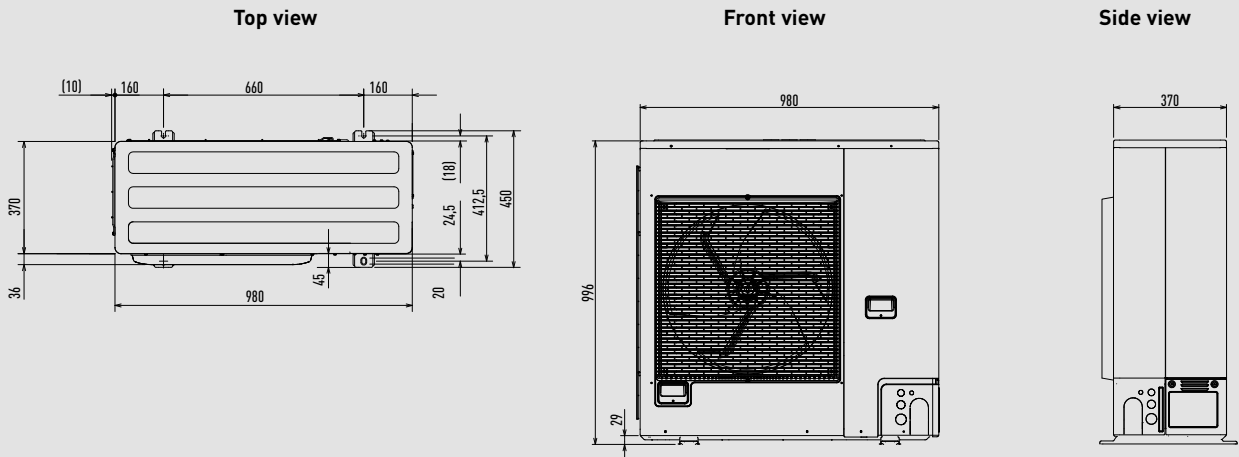

Unit: mm

Mini ECOi LZ2 Series 8 and 10 HP.

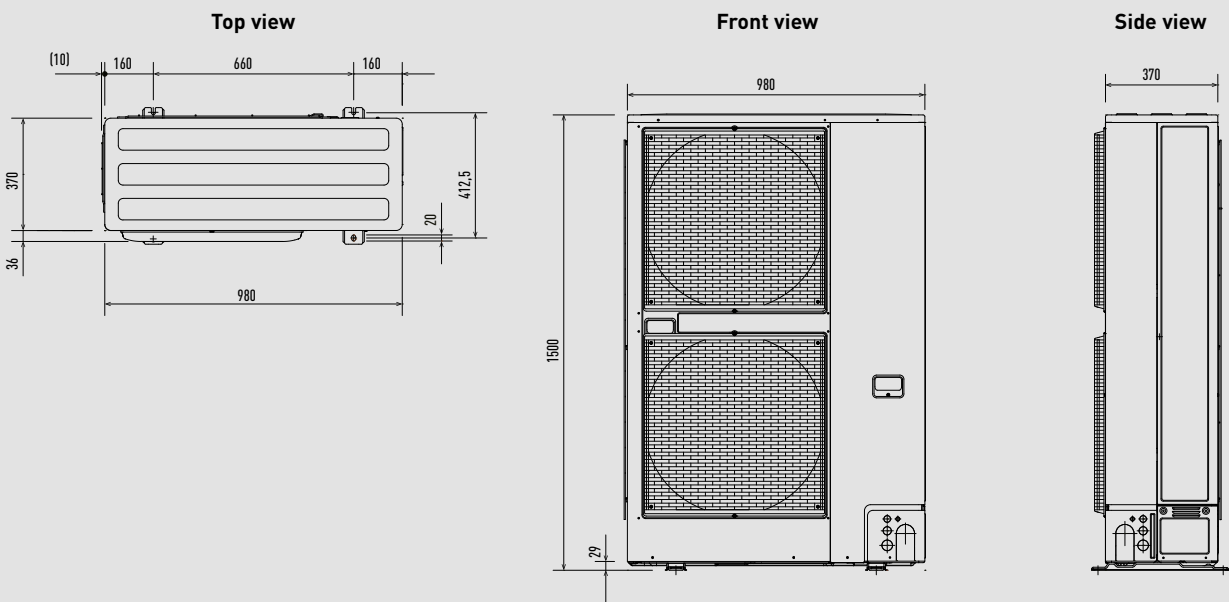

Unit: mm

### Mini ECOi LE2 Series from 4 to 6 HP.

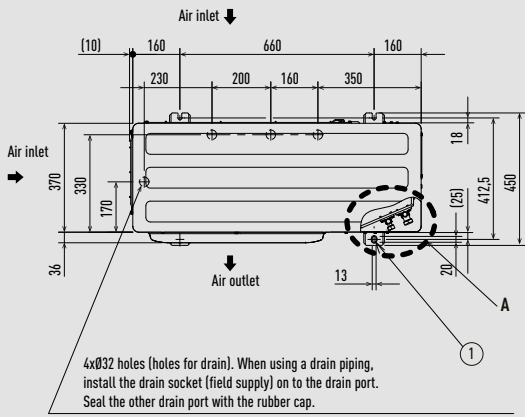

View A

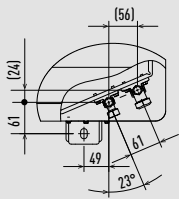

View Z

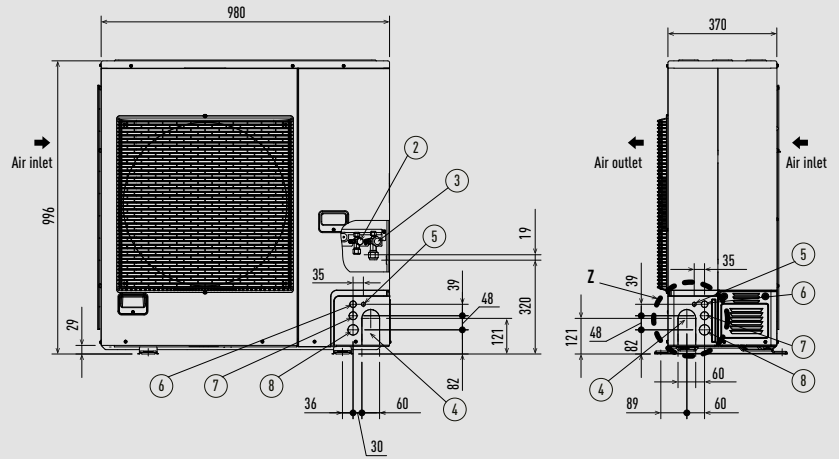
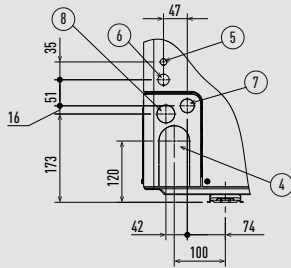

- 1 Mounting hole [4-R6,5], anchor bolt: M10
- 2 Refrigerant piping (liquid), Ø9,52 (flared)
- 3 Refrigerant piping (gas), Ø19,05 (flared)
- 4 Refrigerant piping port
- 5 Electrical wiring port (Ø13)
- 6 Electrical wiring port (Ø22)
- 7 Electrical wiring port (Ø27)
- 8 Electrical wiring port (Ø35)

Unit: mm

### Mini ECOi LE1 Series 8 and 10 HP.

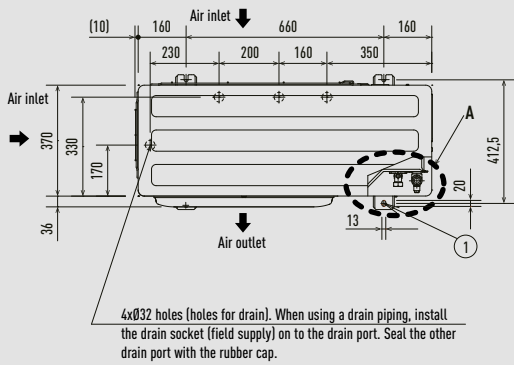

View A

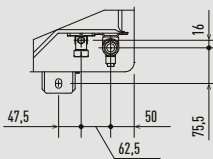

View Z

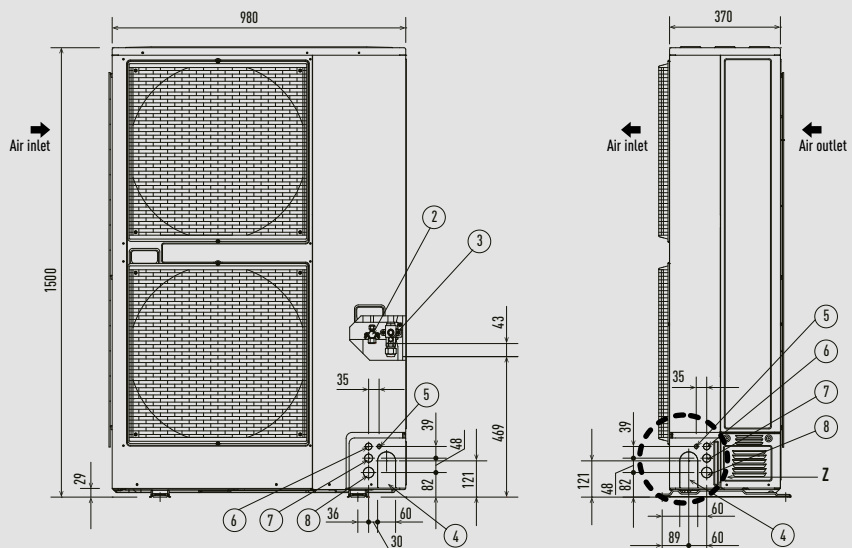
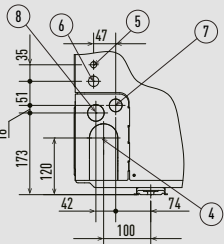

- 1 Mounting hole [4-R6,5], anchor bolt: M10
- 2 Refrigerant piping (liquid), Ø9,52 (flared)
- 3 Refrigerant piping (gas), Ø19,05 (flared)
- 4 Refrigerant piping port

- 5 Electrical wiring port (Ø13)
- 6 Electrical wiring port (Ø22)
- 7 Electrical wiring port (Ø27)
- 8 Electrical wiring port (Ø35)

The piping of the gas main has a diameter of Ø22,22, but the connection to the service valve of the outdoor unit has a diameter of Ø19,05, so a flare has to be used. Consequently, be sure to use the enclosed joint piping B and joint piping A in making connections (brazed).

Unit: mm

2-Pipe ECOi EX MZ1 Series 8, 10 and 12 HP.

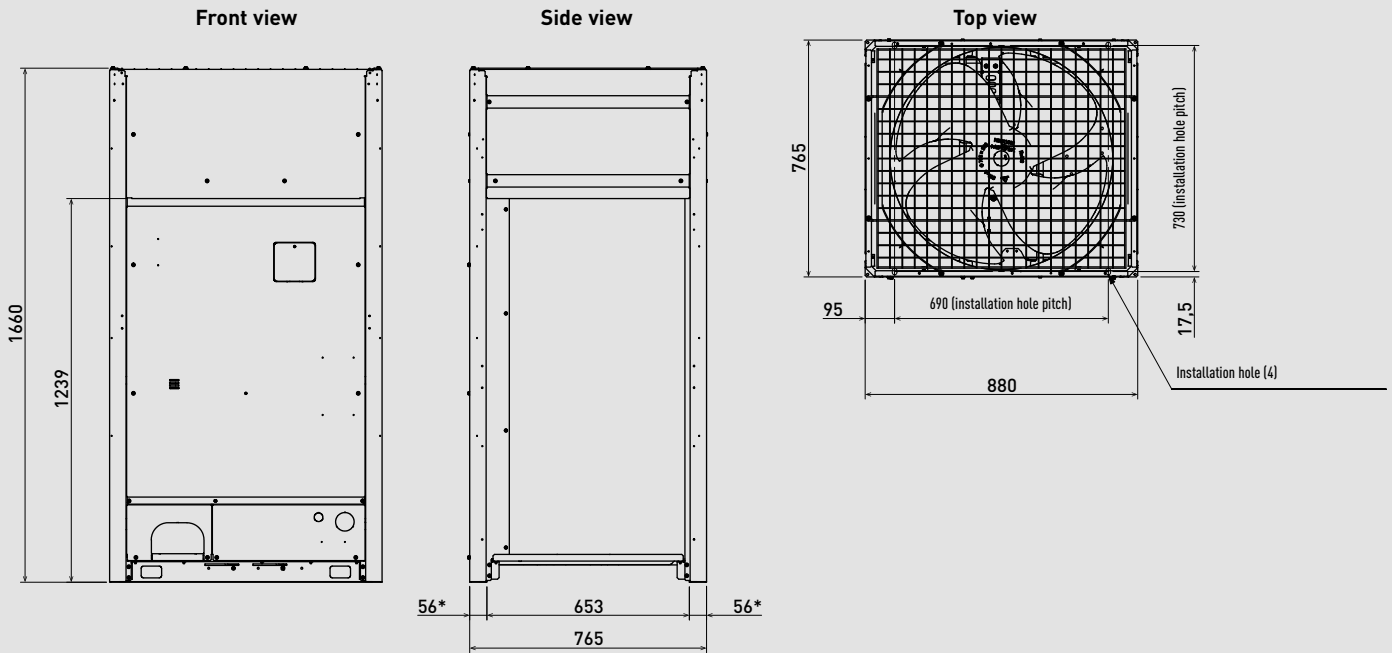

Unit: mm

2-Pipe ECOi EX ME2 Series 8 and 10 HP.

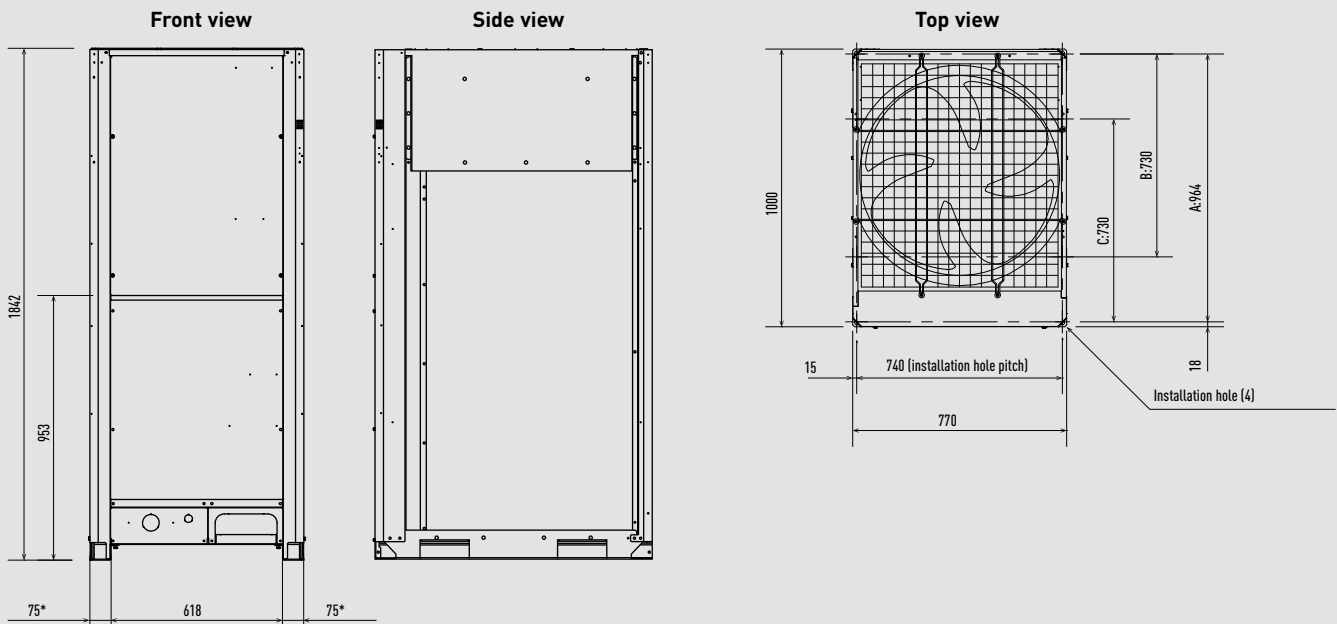

According to the installation site, you may choose the setting position in the depth direction of the anchor bolt from A, B or C.

A: 964 (installation hole pitch). The piping is routed out from the front.  
B: 730 (installation hole pitch)\*. The piping is routed out from the bottom.  
C: 730 (installation hole pitch).

\* Installation fixing bracket. Installation side.

Unit: mm

2-Pipe ECOi EX ME2 Series 12, 14 and 16 HP / 3-Pipe ECOi EX MF3 Series.

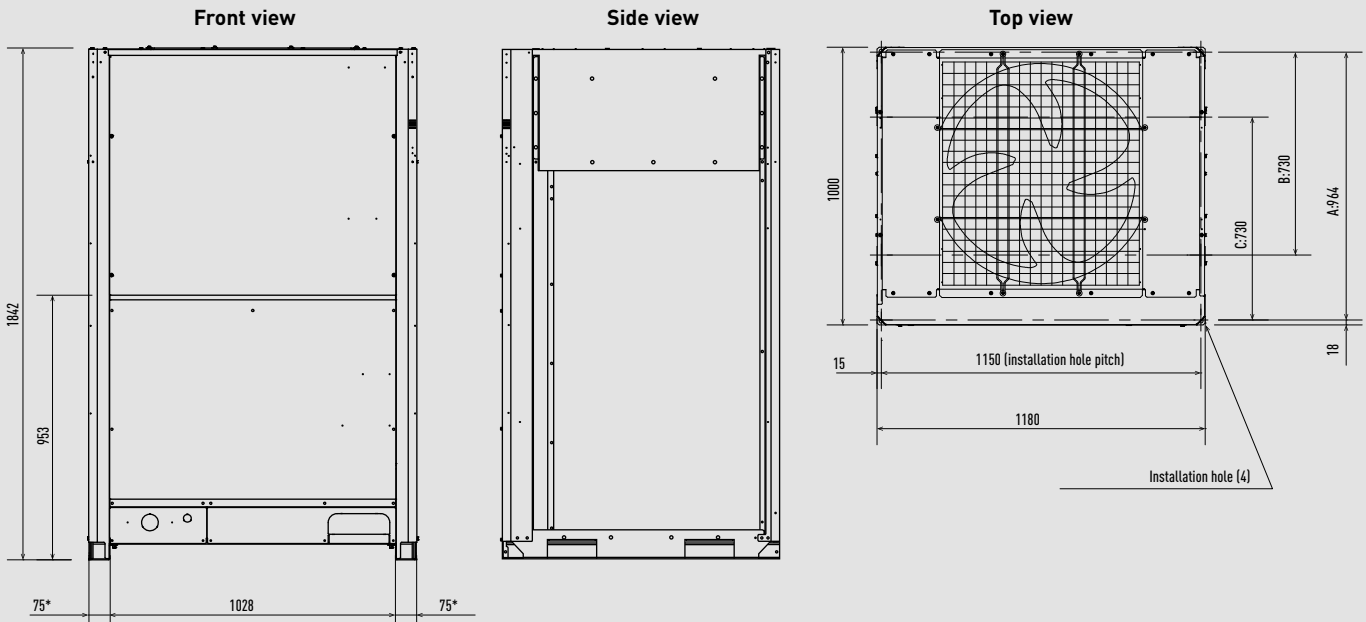

According to the installation site, you may choose the setting position in the depth direction of the anchor bolt from A, B or C.

- A: 964 (installation hole pitch). The piping is routed out from the front.
- B: 730 (installation hole pitch)\*. The piping is routed out from the bottom.
- C: 730 (installation hole pitch).

\* Installation fixing bracket. Installation side.

Unit: mm

2-Pipe ECOi EX ME2 Series 18 and 20 HP.

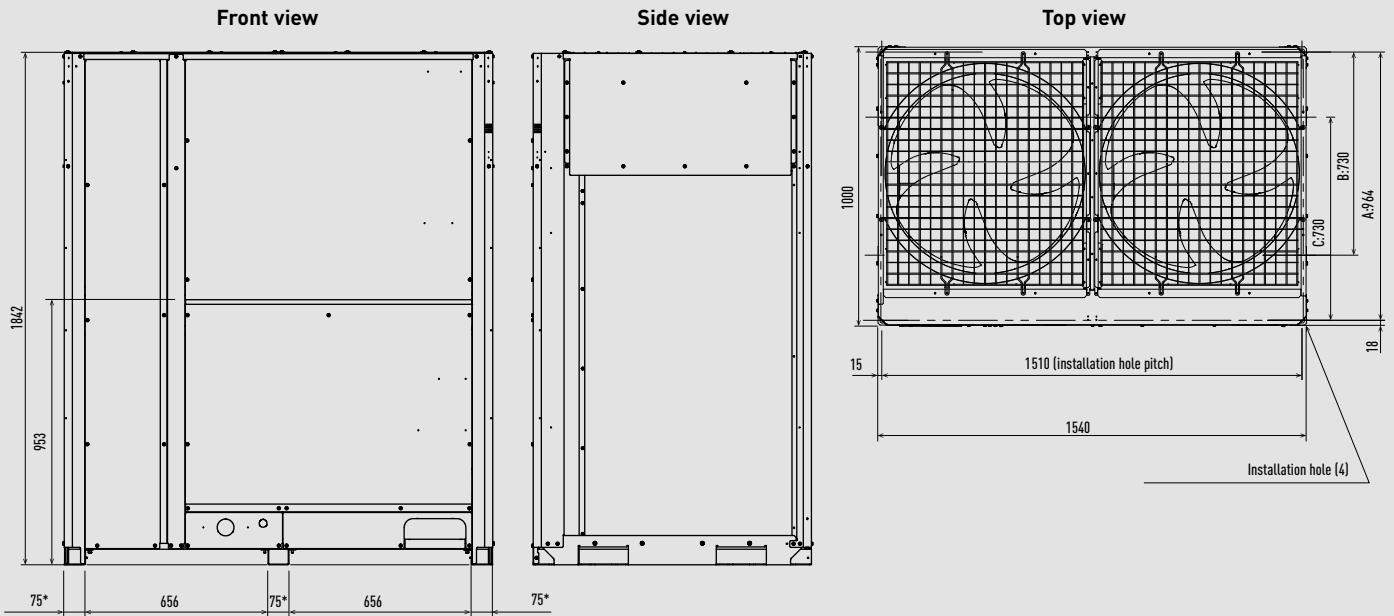

According to the installation site, you may choose the setting position in the depth direction of the anchor bolt from A, B or C.

- A: 964 (installation hole pitch). The piping is routed out from the front.
- B: 730 (installation hole pitch)\*. The piping is routed out from the bottom.
- C: 730 (installation hole pitch).

\* Installation fixing bracket. Installation side.

Unit: mm



### 2-Pipe ECO G GE3 Series 16 and 20 HP.

Type	16 HP	20 HP
1 Refrigerant piping (gas)	Ø28,58	
2 Refrigerant piping (liquid)	Ø12,70	Ø15,88
3 Exhaust gas drain port	Hose outer diameter: Ø25 (accessory)	
4 Electrical power supply port	Ø28	
5 Inter-unit cable port	Ø28	
6 Fuel gas port	R3/4	
7 Condensation drain opening	Ø20	
8 Rain and condensation outlet		

Type	16 HP	20 HP
9 Engine exhaust outlet		
10 Suspension holes 4-Ø20x30		
11 Anchor holes 4-22x30		
12 Segmented display		
13 Coolant intake (top)		
14 Air inlet		
15 Coolant level		
16 Hot water inlet	Rp3/4	
17 Hot water outlet	Rp3/4	

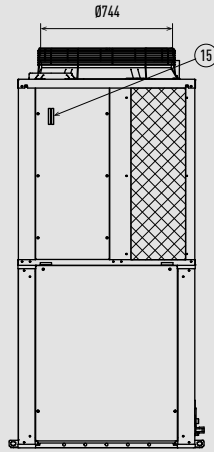
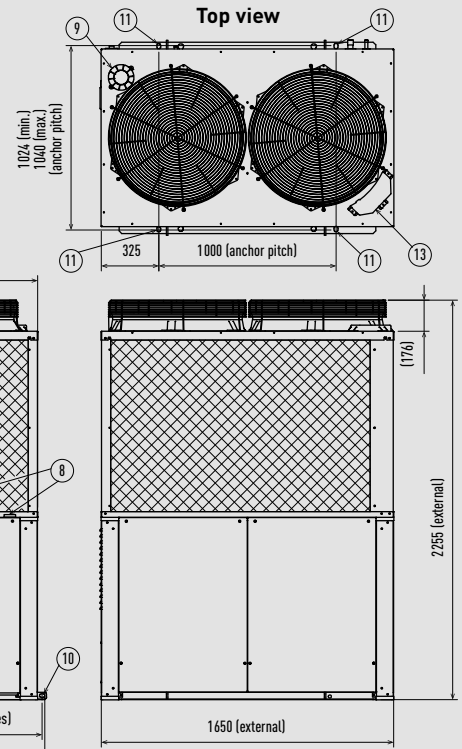

Right view

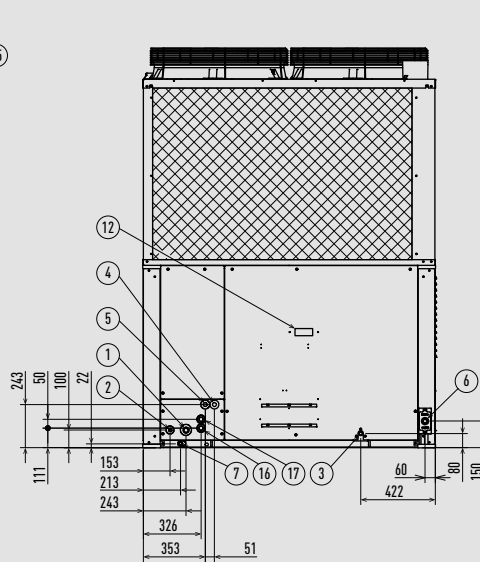

Rear view

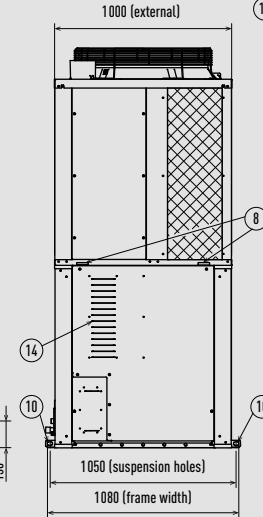

Left view

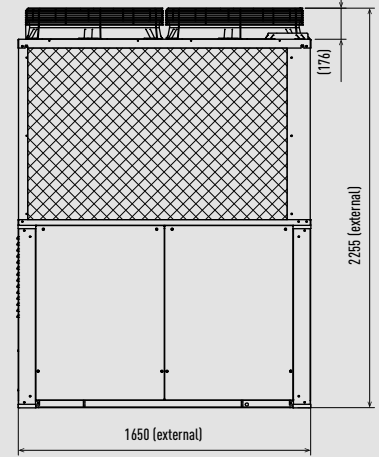

Front view

Unit: mm

### 2-Pipe ECO G GE3 Series 25 and 30 HP.

Type	25 HP	30 HP
1 Refrigerant piping (gas)	Ø28,58	Ø31,75
2 Refrigerant piping (liquid)	Ø15,88	Ø19,05
3 Exhaust gas drain port	Hose outer diameter: Ø25 (accessory)	
4 Electrical power supply port	Ø28	
5 Inter-unit cable port	Ø28	
6 Fuel gas port	R3/4	
7 Condensation drain opening	Ø20	
8 Rain and condensation outlet		

Type	25 HP	30 HP
9 Engine exhaust outlet		
10 Suspension holes 4-Ø20x30		
11 Anchor holes 4-22x30		
12 Segmented display		
13 Coolant intake (top)		
14 Air inlet		
15 Coolant level		
16 Hot water inlet	Rp3/4	
17 Hot water outlet	Rp3/4	

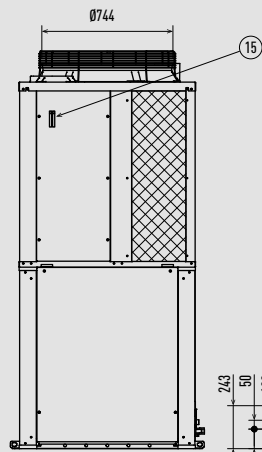
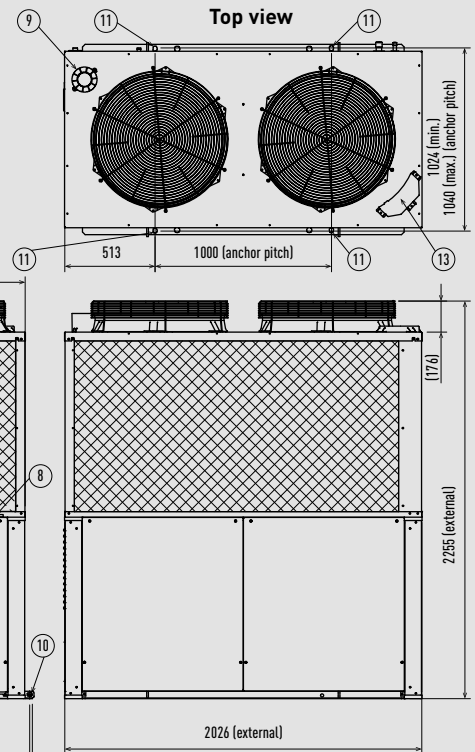

Right view

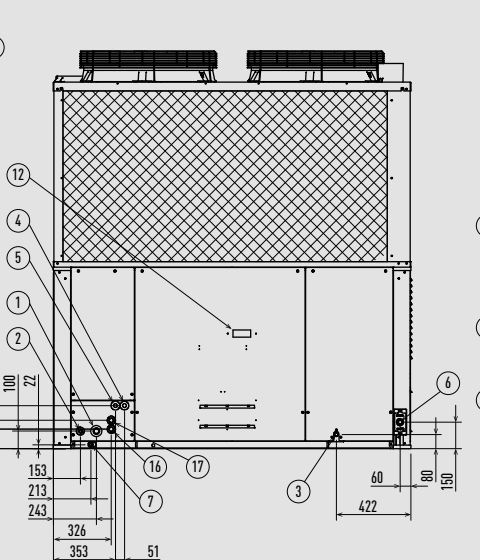

Rear view

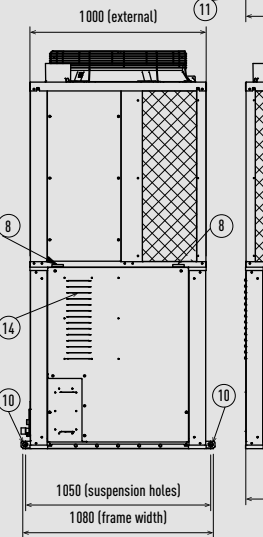

Left view

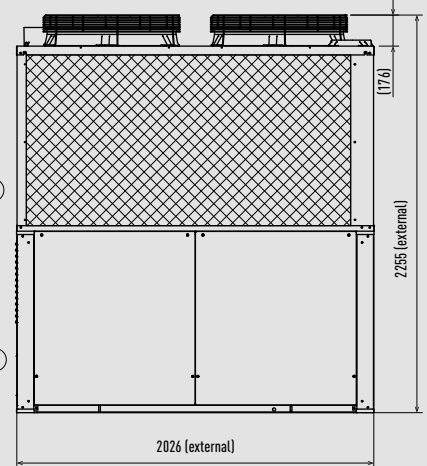

Front view

Unit: mm

### 3-Pipe ECO G GF3 Series 16 and 20 HP.

Type	16HP	20HP
1 Suction refrigerant piping (gas)	Ø28,58	
2 Discharge refrigerant piping (gas)	Ø22,22	Ø25,40
3 Refrigerant piping (liquid)	Ø19,05	
4 Exhaust gas drain port	Hose outer diameter: Ø25 (accessory)	
5 Electrical power supply port	Ø28	
6 Inter-unit cable port	Ø28	
7 Fuel gas port	R3/4	
8 Condensation drain opening	Ø20	

Type	16HP	20HP
9 Rain and condensation outlet		
10 Engine exhaust outlet		
11 Suspension holes 4-Ø20x30		
12 Anchor holes 4-22x30		
13 Segmented display		
14 Coolant intake (top)		
15 Air inlet		
16 Coolant level		
17 Hot water inlet	Rp3/4	
18 Hot water outlet	Rp3/4	

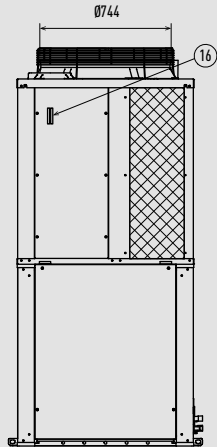
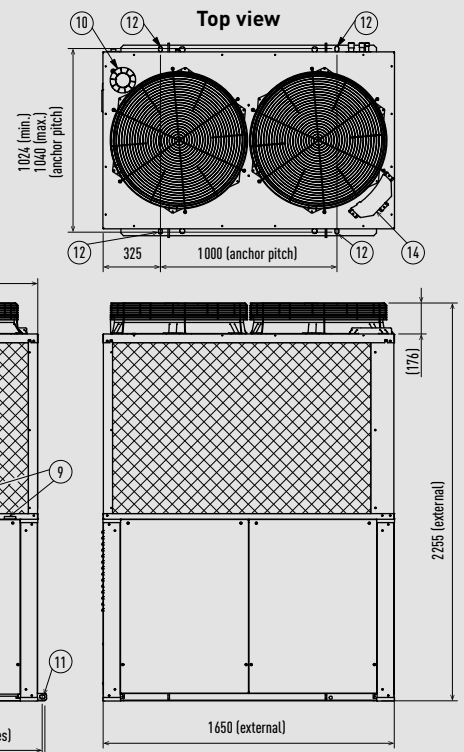

Right view

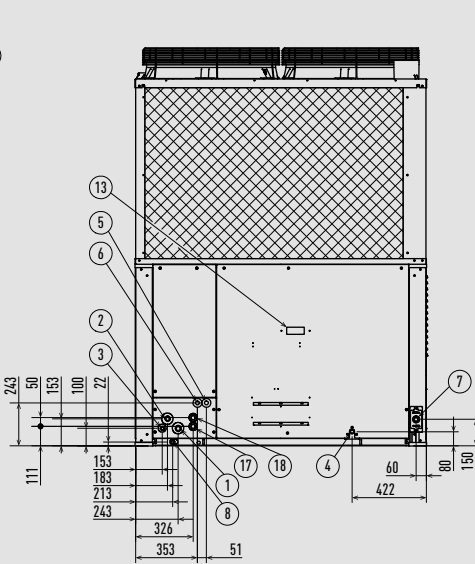

Rear view

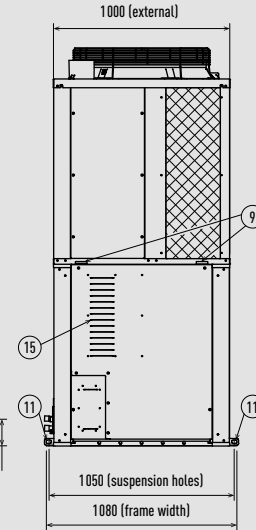

Left view

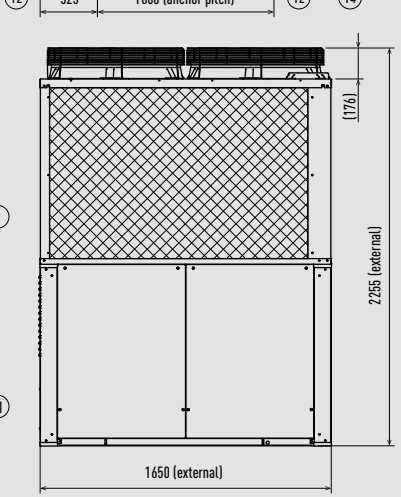

Front view

Unit: mm

### 3-Pipe ECO G GF3 Series 25 HP.

1 Suction refrigerant piping (gas)	Ø28,58	
2 Discharge refrigerant piping (gas)	Ø25,40	
3 Refrigerant piping (liquid)	Ø19,05	
4 Exhaust gas drain port	Hose outer diameter: Ø25 (accessory)	
5 Electrical power supply port	Ø28	
6 Inter-unit cable port	Ø28	
7 Fuel gas port	R3/4	
8 Condensation drain opening	Ø20	

9 Rain and condensation outlet		
10 Engine exhaust outlet		
11 Suspension holes 4-Ø20x30		
12 Anchor holes 4-22x30		
13 Segmented display		
14 Coolant intake (top)		
15 Air inlet		
16 Coolant level		
17 Hot water inlet	Rp3/4	
18 Hot water outlet	Rp3/4	

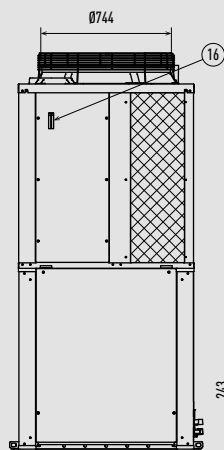
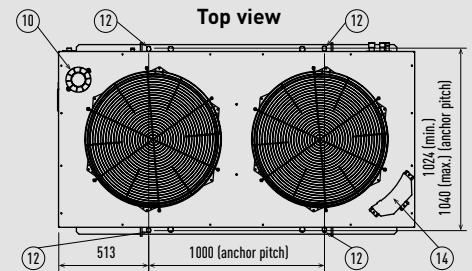

Right view

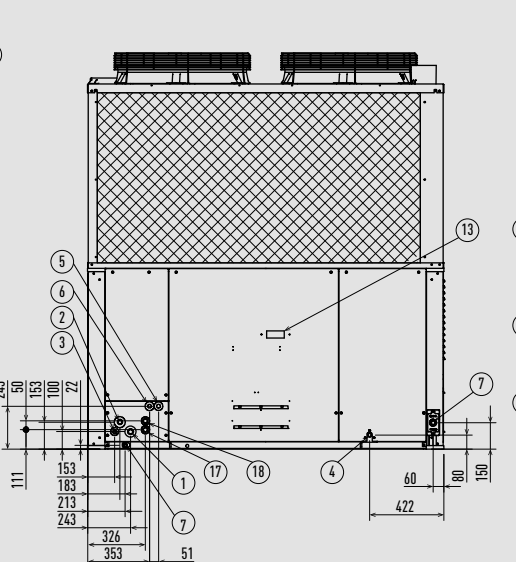

Rear view

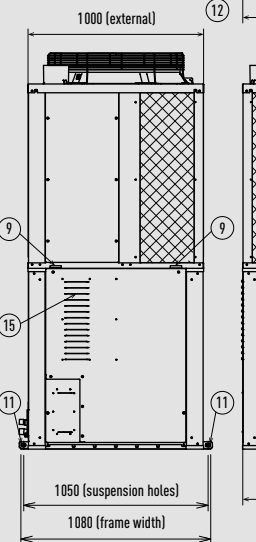

Left view

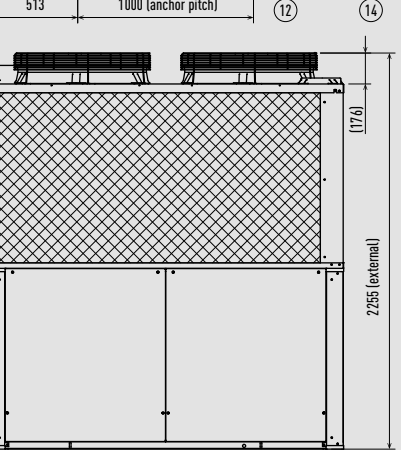

Front view

Unit: mm

### 3-Pipe Control Box Kit / Multiple connection type.

#### Heat recovery box dimensions

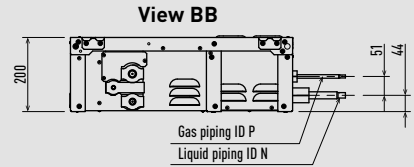
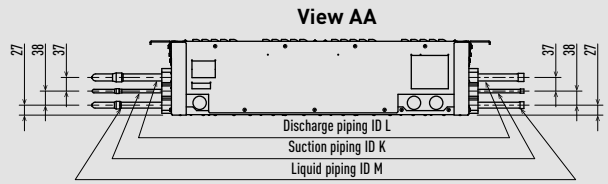
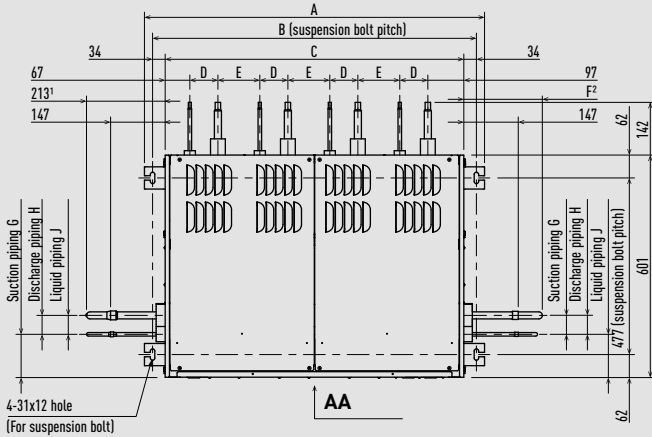

BB

	A	B	C	D	E	F	G	H	J	K	L	M	N	P
Type 456	919	874	807	67	113	213	51	51	117	Ø19,05	Ø15,88	Ø9,52	Ø6,35	Ø12,70
Type 4160	919	874	807	67	113	207	55	54	113	Ø9,52	Ø15,88	Ø28,58	Ø25,40	Ø15,88
Type 656	1297	1253	1185	67	113	213	54	55	115	Ø25,40	Ø19,05	Ø12,70	Ø6,35	Ø12,70
Type 856	1675	1631	1563	67	113	213	53	53	115	Ø28,58	Ø22,22	Ø12,70	Ø6,35	Ø12,70

- 1) In case of right side connection.
- 2) Including the protection tubes when connecting to the left side.

#### Valve dimensions

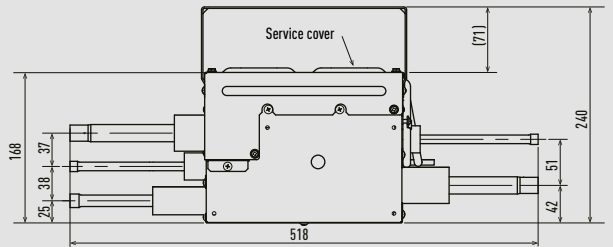
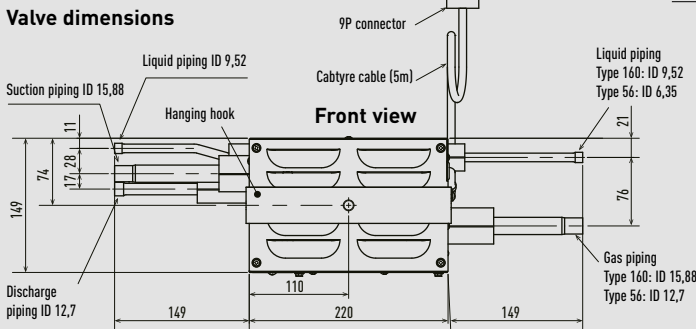

Unit: mm

### 2-Pipe Hybrid GHP - U-20GES3E5.

- |  |                              |
|--|------------------------------|
| 1 Refrigerant piping (gas), Ø28,58                             | 10 Engine exhaust outlet     |
| 2 Refrigerant piping (liquid), Ø15,88                          | 11 Suspension holes 4-Ø20x30 |
| 3 Knock-out hole. Refrigerant piping (balance)                 | 12 Anchor holes 4-22x30      |
| 4 Exhaust gas drain port. Hose outer diameter: Ø25 (accessory) | 13 7 segmented display       |
| 5 Electrical power supply port, Ø28                            | 14 Coolant intake (top)      |
| 6 Inter-unit cable port, Ø28                                   | 15 Air inlet                 |
| 7 Fuel gas port, R3/4  | 16 Coolant level             |
| 8 Condensation drain opening, Ø20                              | 17 Hot water inlet, Rp3/4    |
| 9 Rain and condensation outlet                                 | 18 Hot water outlet, Rp3/4   |

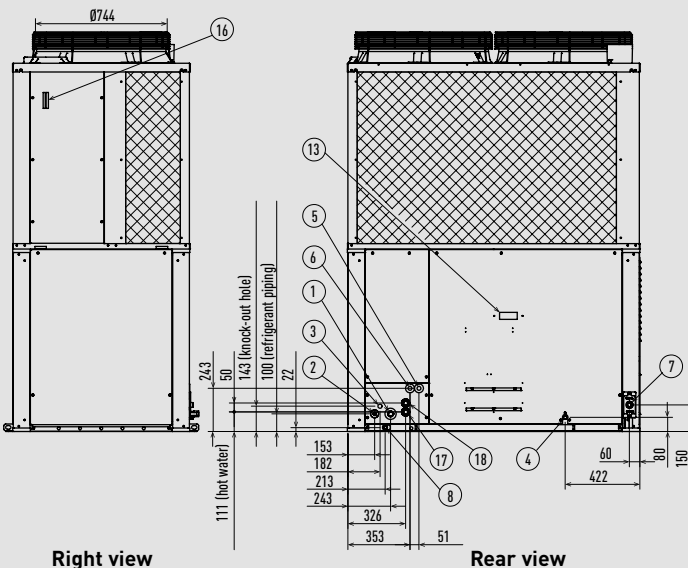
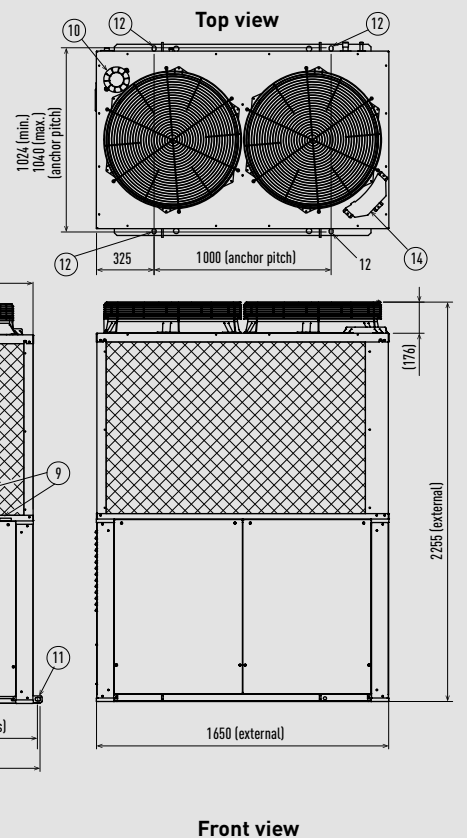

Unit: mm

## 2-Pipe Hybrid EHP - U-10MES2E8.

Top view

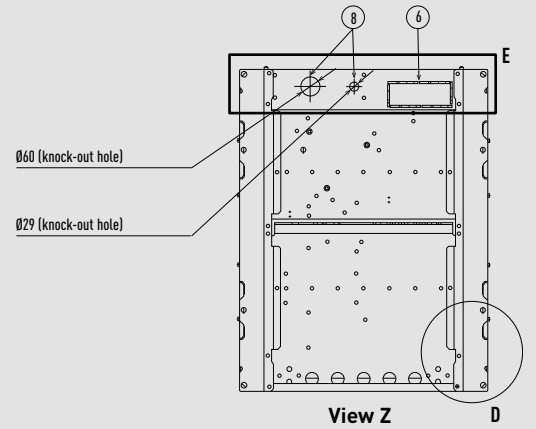
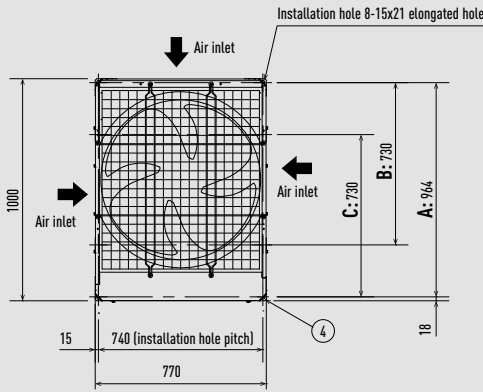

Front view

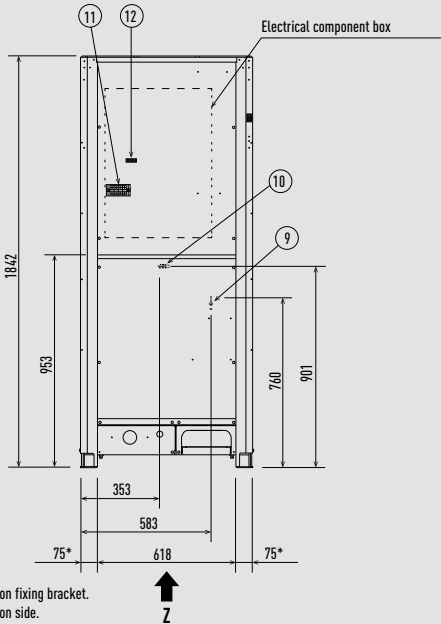

Side view

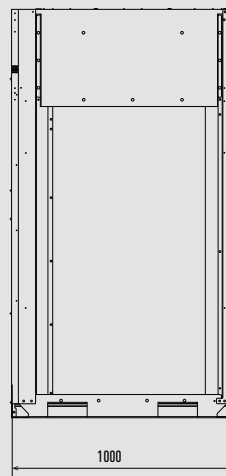

View D

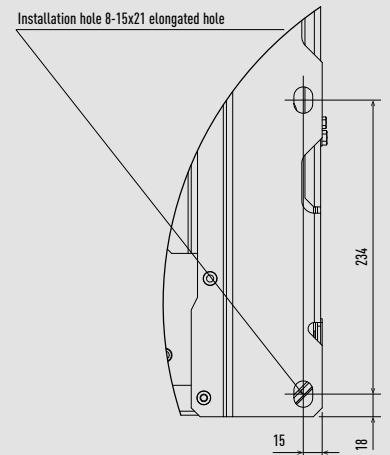

\* Installation fixing bracket.  
Installation side.

View E

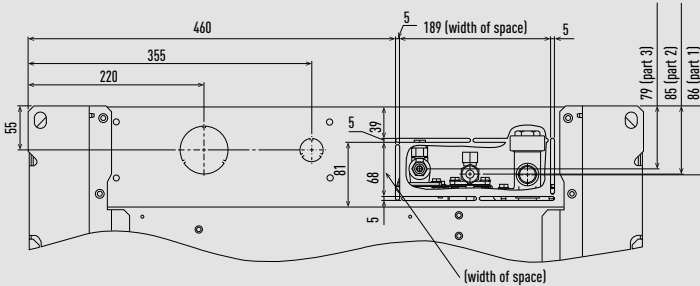

### Position of refrigerant piping connection

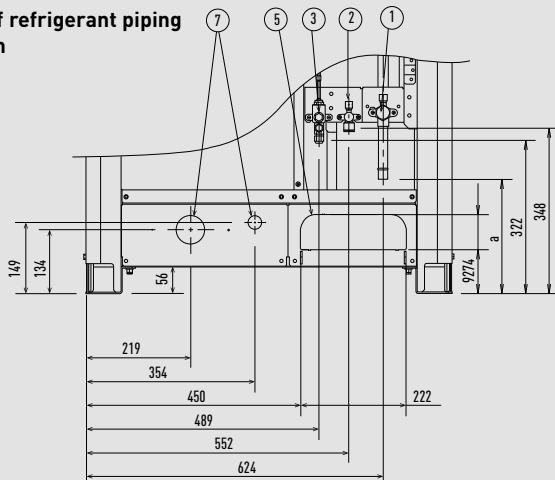

- 1 Refrigerant piping (gas), Ø22,22 (brazed)
- 2 Refrigerant piping (liquid), Ø9,52 (flared)
- 3 Refrigerant piping (balance), Ø6,35 (flared)
- 4 Installation hole (8-15x21 elongated holes), anchor bolts M12 or larger
- 5 Refrigerant piping port (front: knock-out hole)
- 6 Refrigerant piping port (bottom: slit hole)
- 7 Electrical wiring port (front: Ø60, Ø29 knock-out hole - for conduit connection)
- 8 Electrical wiring port (bottom: Ø60, Ø29 knock-out hole - for conduit connection)
- 9 Pressure outlet port (for high pressure: Ø7,94 Schrader type connection)
- 10 Pressure outlet port (for low pressure: Ø7,94 Schrader type connection)
- 11 Terminal plate
- 12 Terminal plate for inter-unit control wiring and/or inter-outdoor unit control wiring

According to the installation site, you may choose the setting position in the depth direction of the anchor bolt from A, B or C.

A: 964 (installation hole pitch). The piping is routed out from the front.  
B: 730 (installation hole pitch)\*. The piping is routed out from the bottom.  
C: 730 (installation hole pitch).

\* Installation fixing bracket. Installation side.

Water Heat Exchanger for chilled and hot water production.

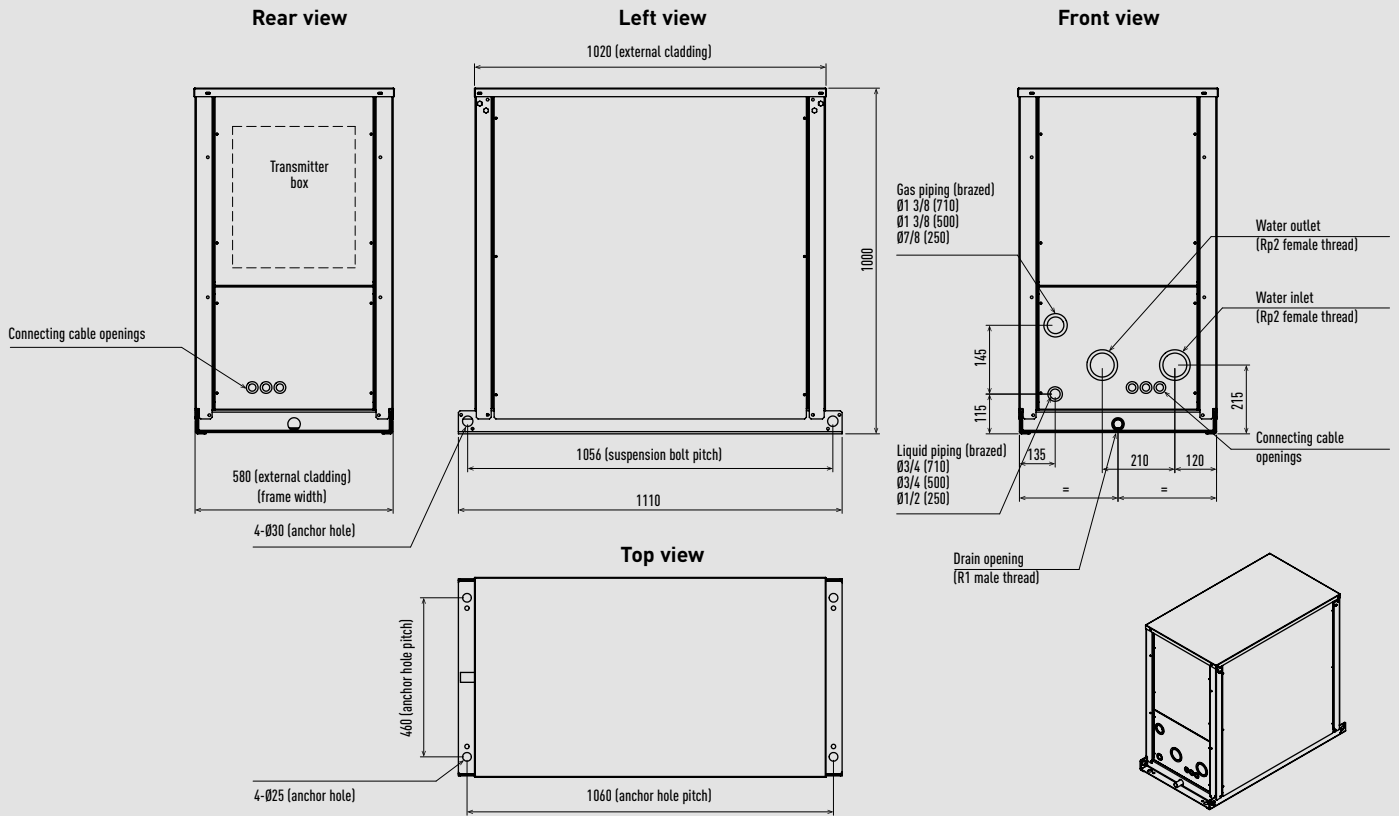

Unit: mm

U2 type 4 way 90x90 cassette.

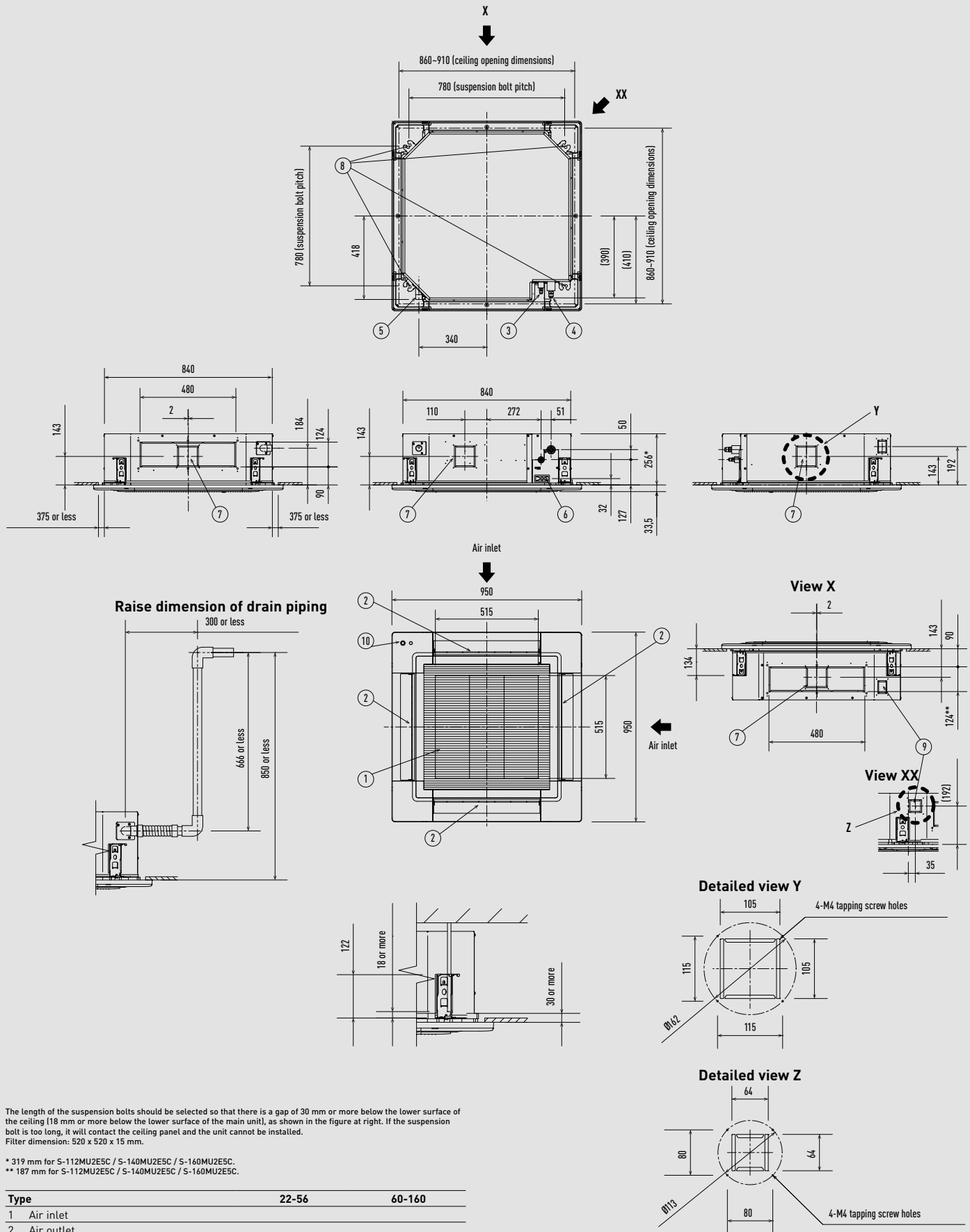

The length of the suspension bolts should be selected so that there is a gap of 30 mm or more below the lower surface of the ceiling (18 mm or more below the lower surface of the main unit), as shown in the figure at right. If the suspension bolt is too long, it will contact the ceiling panel and the unit cannot be installed.  
Filter dimension: 520 x 520 x 15 mm.

\* 319 mm for S-112MU2E5C / S-140MU2E5C / S-160MU2E5C.  
\*\* 187 mm for S-112MU2E5C / S-140MU2E5C / S-160MU2E5C.

Type	22-56	60-160
1 Air inlet		
2 Air outlet		
3 Refrigerant piping (liquid)	$\varnothing 6,35$ (flared)	$\varnothing 9,52$ (flared)
4 Refrigerant piping (gas)	$\varnothing 12,70$ (flared)	$\varnothing 15,88$ (flared)
5 Drain piping connection port VP25	Outer diameter 32 mm	
6 Power supply port		
7 Suspension bolt hole	4-12x30 elongated hole	
8 Fresh air inlet duct connection port	$\varnothing 100$ <sup>1)</sup>	
9 Suspension bolt hole	4-12x30 elongated hole	
10 Econavi sensor (only CZ-KPU3A)		

1) Necessary to attach duct connecting flange (field supplied).

Unit: mm

Y3 type 4 way 60x60 cassette.

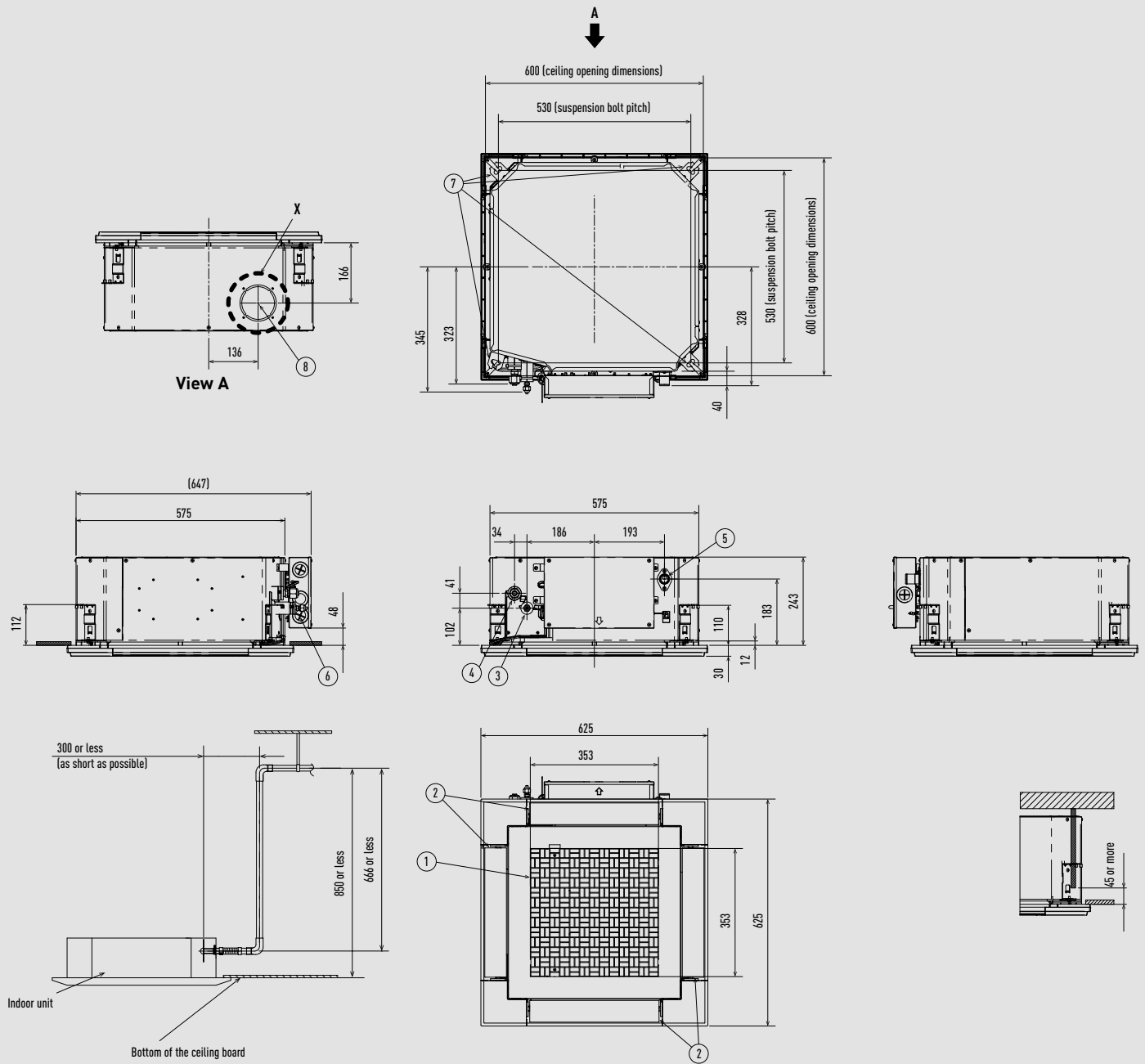

\* Length of supplied drain piping= 250 mm.

1	Air inlet	
2	Air outlet	
3	Refrigerant piping (liquid)	Ø6,35 (flared)
4	Refrigerant piping (gas)	Ø12,70 (flared)
5	Drain piping connection port VP20	
6	Power supply port	
7	Suspension bolt hole [4-11x26 slot]	
8	Fresh air inlet duct connection port (Ø100) <sup>1)</sup>	

1) Necessary to attach duct connecting flange (field supply).

Filter dimension: 362 x 362 x 15 mm.

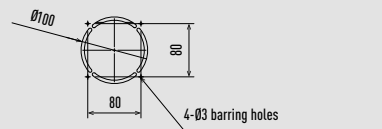

Detailed view X

L1 type 2 way cassette.

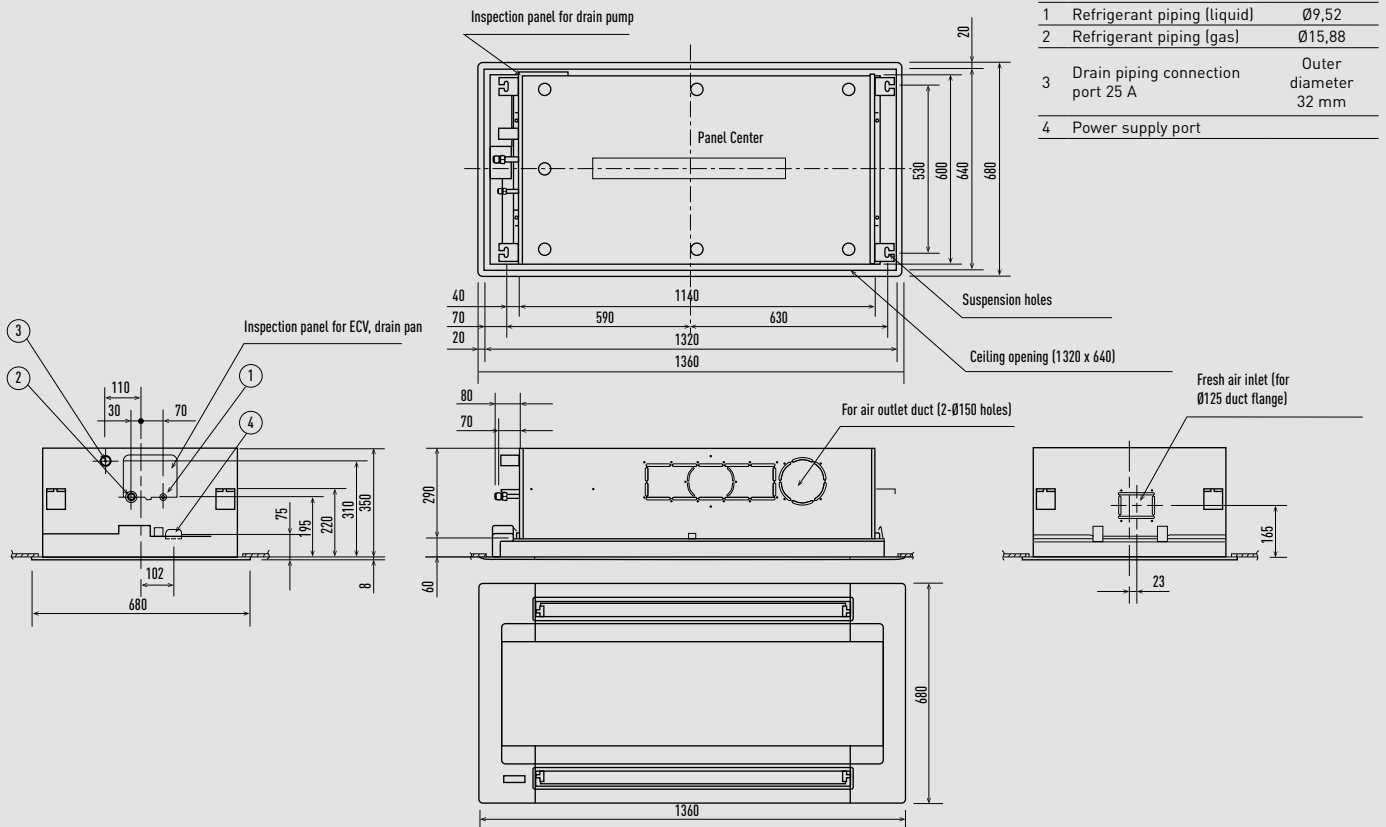

Unit: mm

D1 type 1 way cassette.

	28-56	73
1	Air inlet	
2	Air outlet	
3	Ø6,35 (flared)	Ø9,52 (flared)
4	Ø12,70 (flared)	Ø15,88 (flared)
5	Drain piping connection port VP25	Outer diameter 32 mm
6	Power supply port	
7	Air outlet duct connection port (for descending ceiling)	
8	Fresh air inlet duct connection port Ø100	
9	Wireless remote controller receiver installation location	
10	Suspension bolt hole 4-12x30 mm	

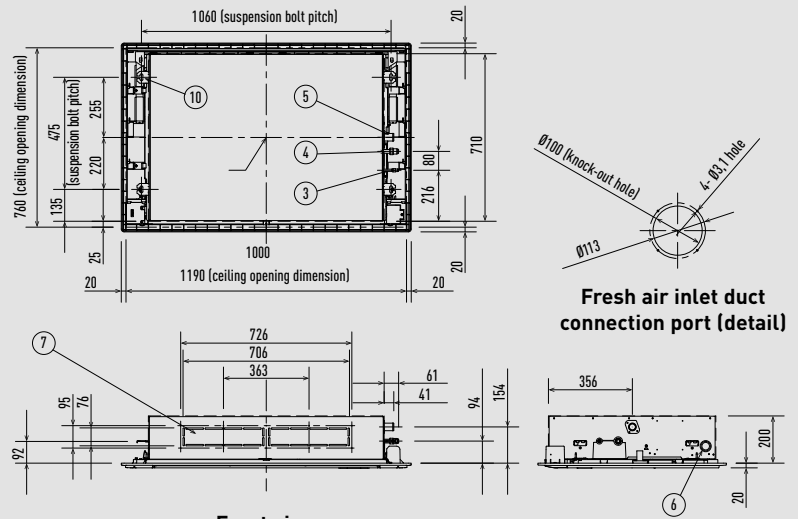

Fresh air inlet duct connection port (detail)

Space necessary for installation

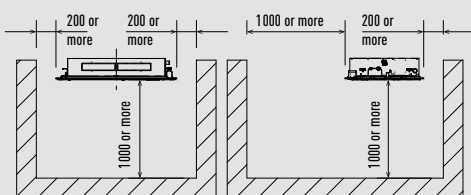

Front view

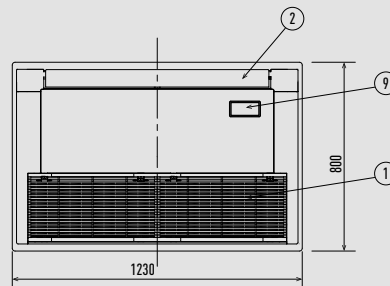

Unit: mm



F3 type variable static pressure adaptive duct.

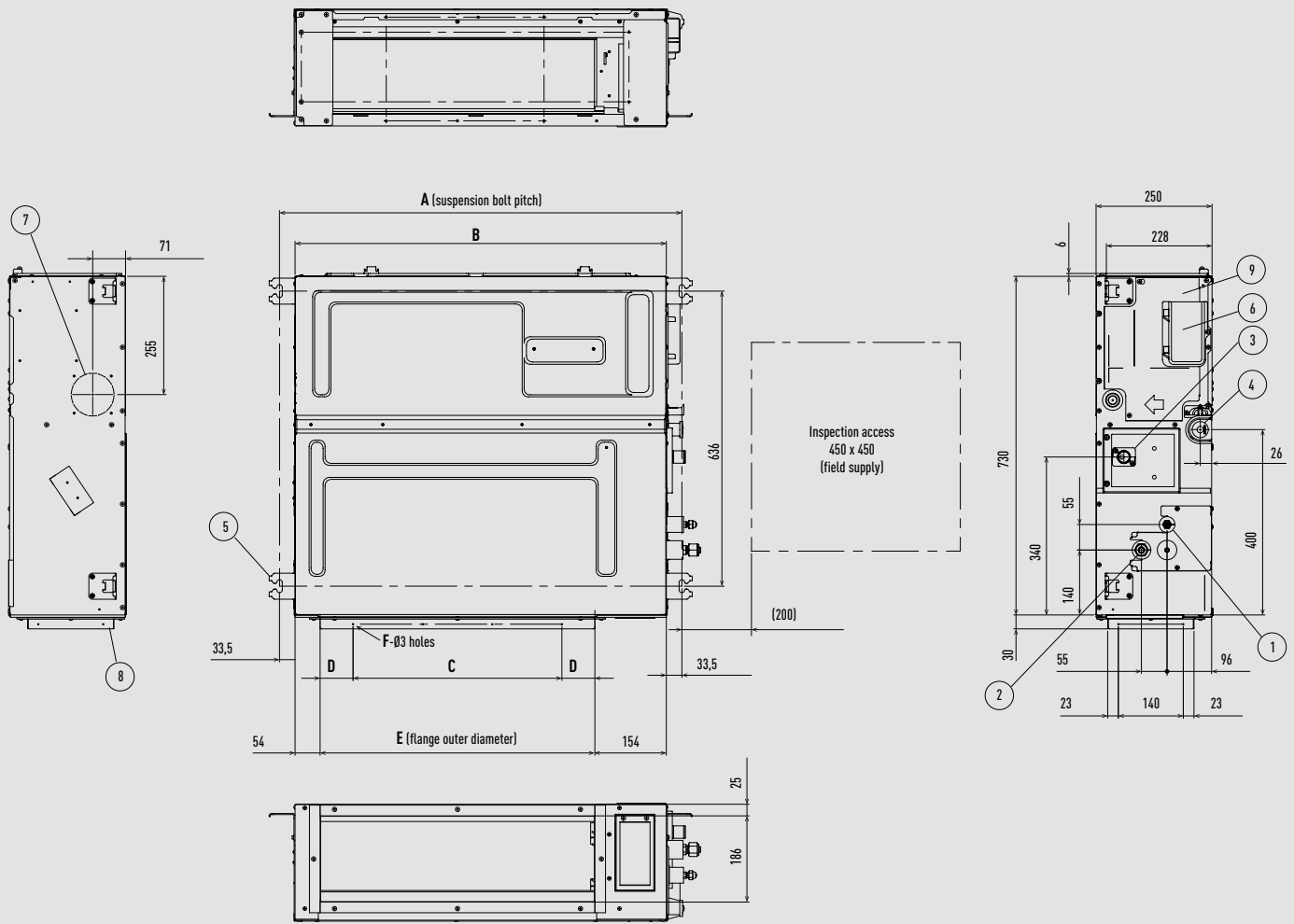

	A	B	C	D	E	F
	mm	mm	mm	mm	mm	Q'ty
<b>S-15MF3E5D, S-22MF3E5D, S-28MF3E5D, S-36MF3E5D, S-45MF3E5D, S-56MF3E5D</b>	867	800	450 [pitch 150 x 3]	71	592	12
<b>S-60MF3E5D, S-73MF3E5D, S-90MF3E5D</b>	1067	1000	750 [pitch 150 x 5]	21	792	16
<b>S-112MF3E5D, S-140MF3E5D, S-160MF3E5D</b>	1467	1400	1050 [pitch 150 x 7]	71	1192	20

Type	15-90	106-160	15-56	60-160
1 Refrigerant piping (liquid)	Ø6,35 (flared)	Ø9,52 (flared)	Ø12,70 (flared)	Ø15,88 (flared)
2 Refrigerant piping (gas)				
3 Upper drain piping connection port VP20		Outer diameter 26 mm, 200 mm flexible hose supplied		
4 Bottom drain piping connection port VP20		Outer diameter 26 mm		
5 Suspension lug		4-12x30 mm		
6 Power supply port				
7 Fresh air inlet duct connection port		Ø100 mm*		
8 Flange for flexible air discharge duct				
9 Electrical component box				

\* Necessary to attach duct connecting flange (field supply).

M2 type slim variable static pressure hide-away concealed duct.

S-10MM2EB / S-15MM2EB / S-22MM2EB / S-28MM2EB / S-36MM2EB

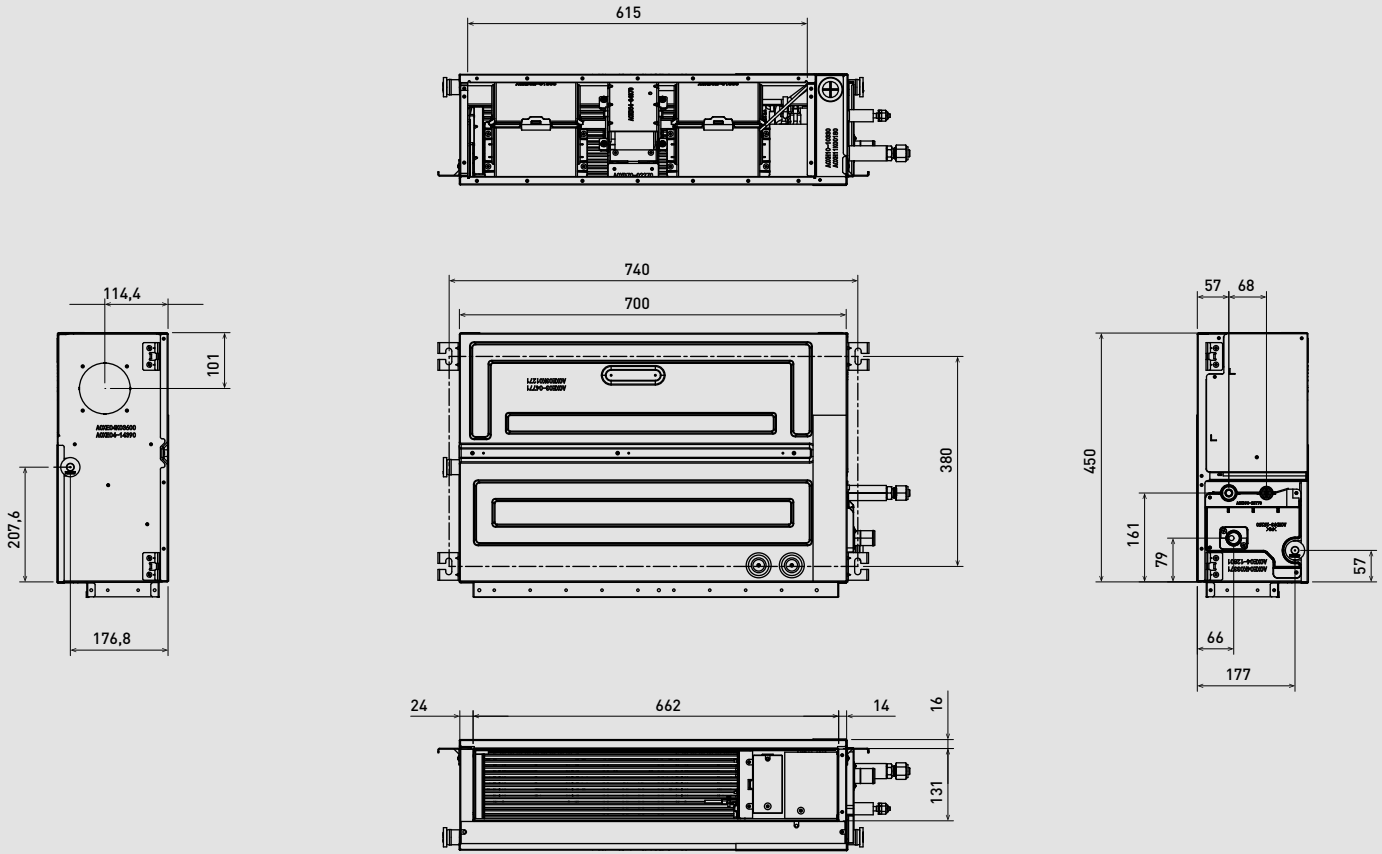

S-45MM2EB / S-56MM2EB

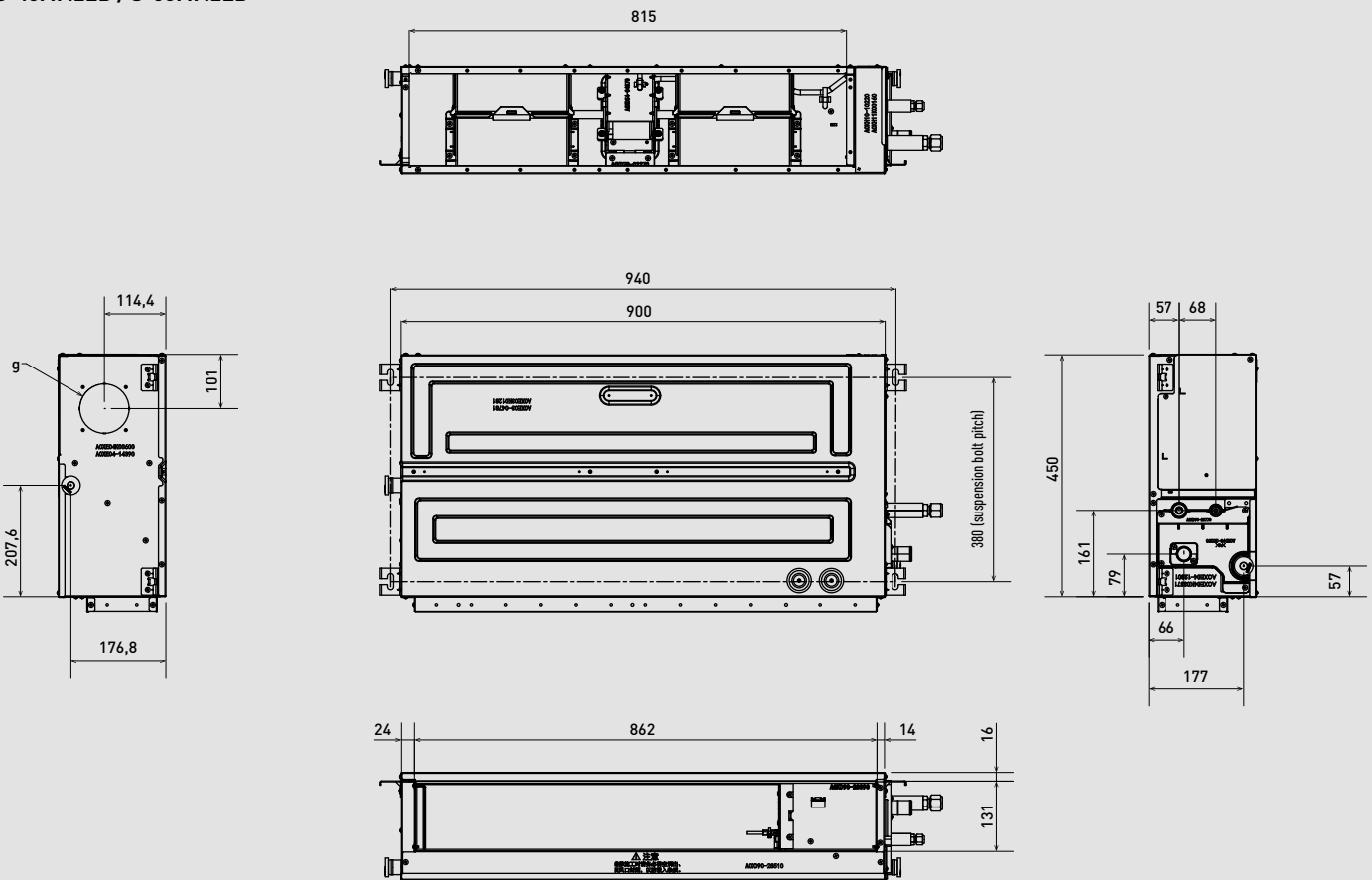

Unit: mm

E2 type high static pressure hide-away.

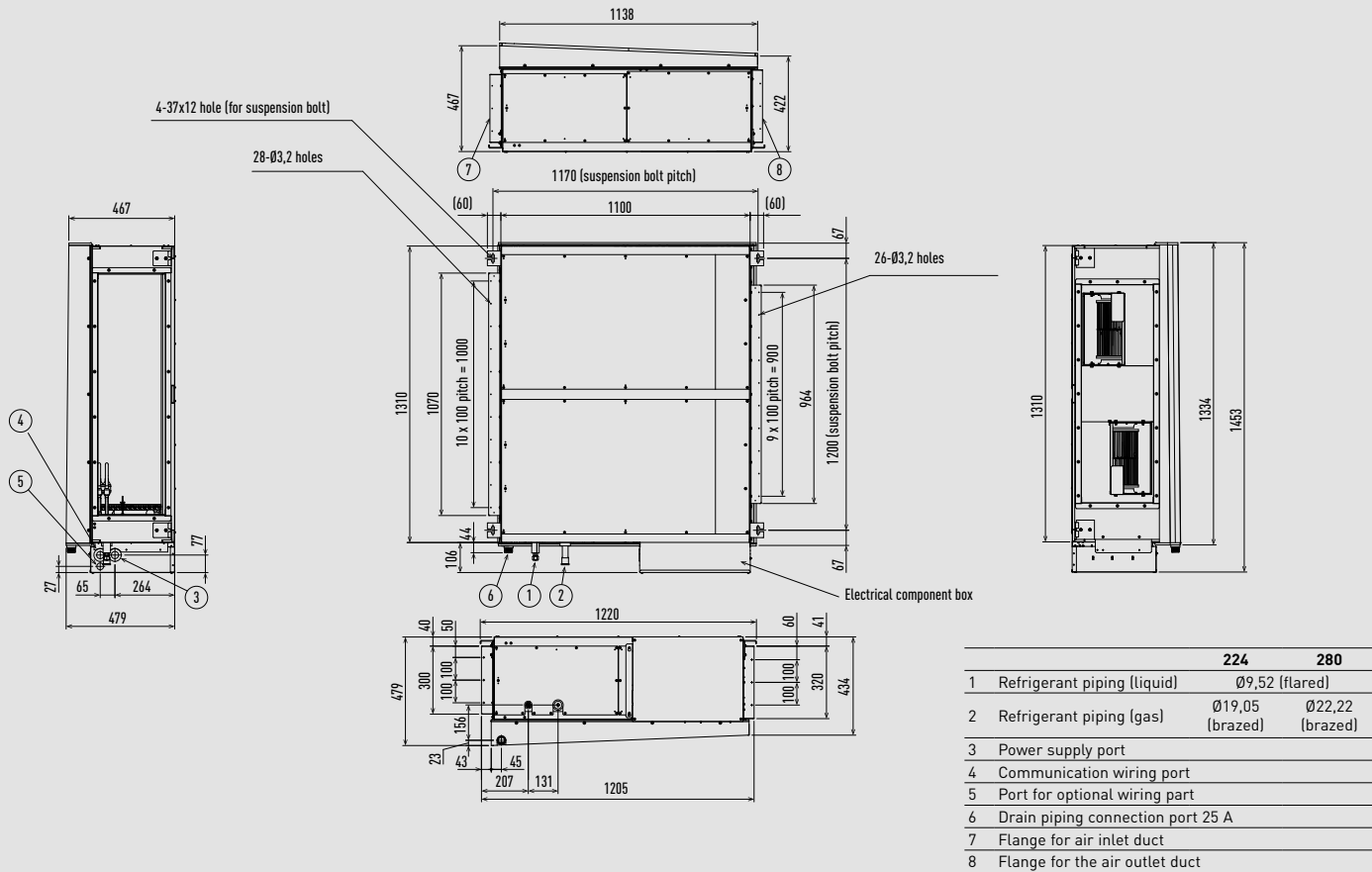

	224	280
1 Refrigerant piping (liquid)	Ø9,52 (flared)	
2 Refrigerant piping (gas)	Ø19,05 (brazed)	Ø22,22 (brazed)
3 Power supply port		
4 Communication wiring port		
5 Port for optional wiring part		
6 Drain piping connection port 25 A		
7 Flange for air inlet duct		
8 Flange for the air outlet duct		

Unit: mm

K3 type wall-mounted.

S-15MK3E / S-22MK3E / S-28MK3E / S-36MK3E / S-45MK3E

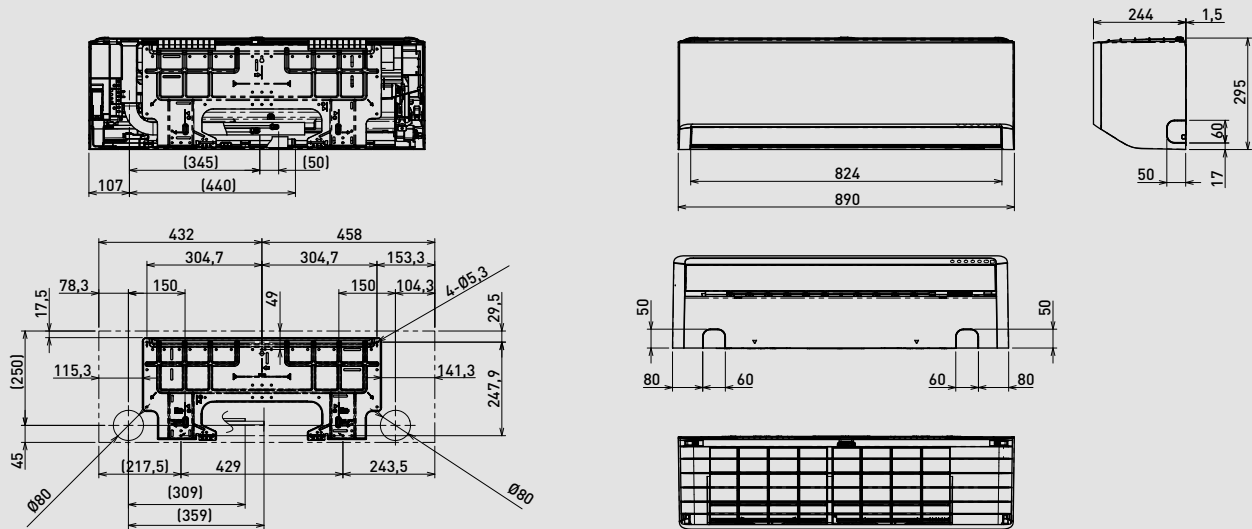

S-56MK3E

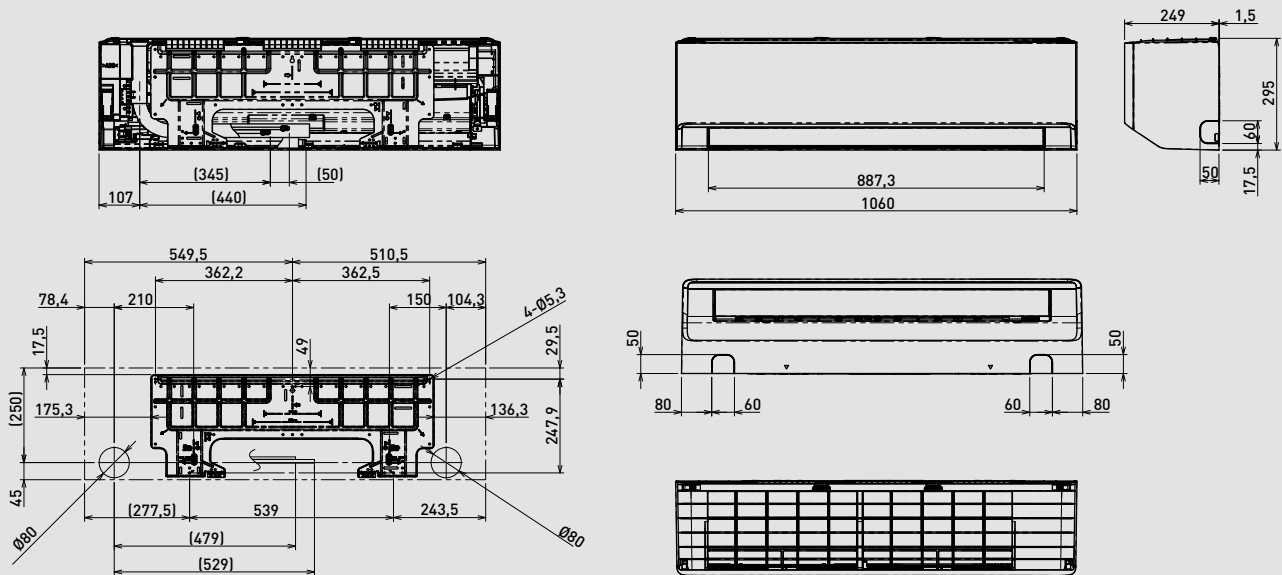

S-73MK3E / S-106MK3E

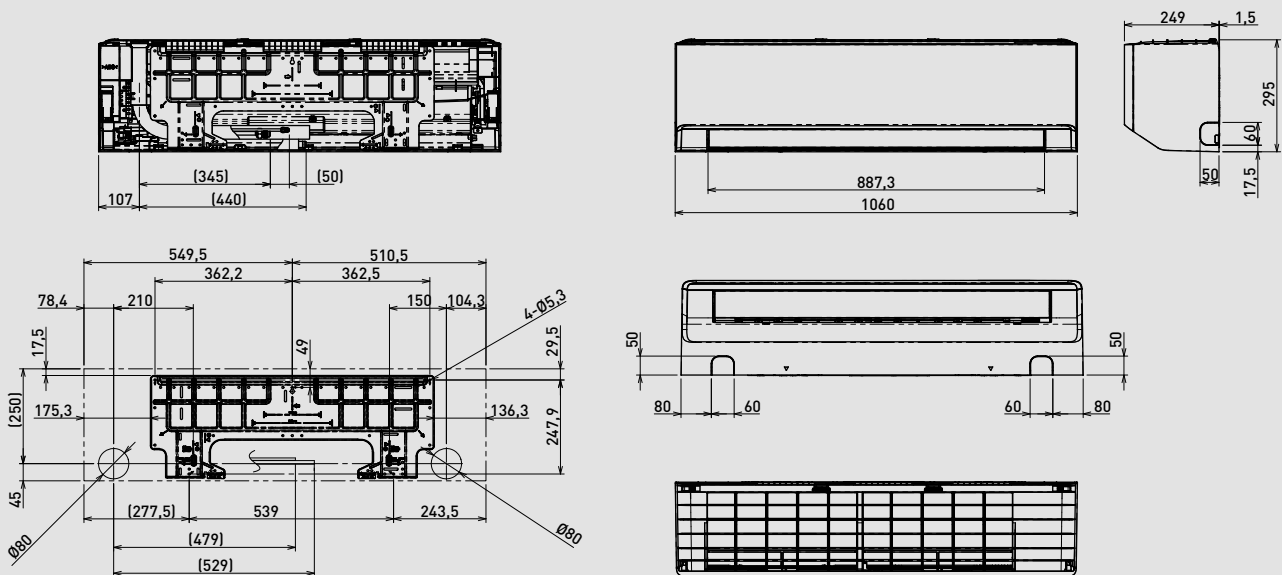

Unit: mm

T2 type ceiling.

S-36MT2E5A / S-45MT2E5A / S-56MT2E5A

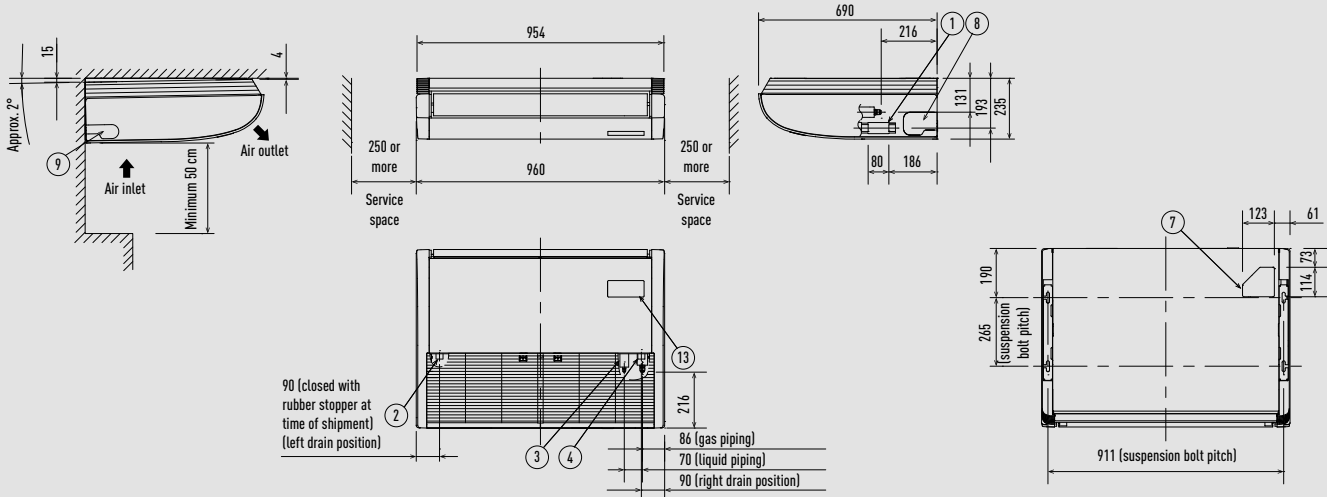

S-73MT2E5A

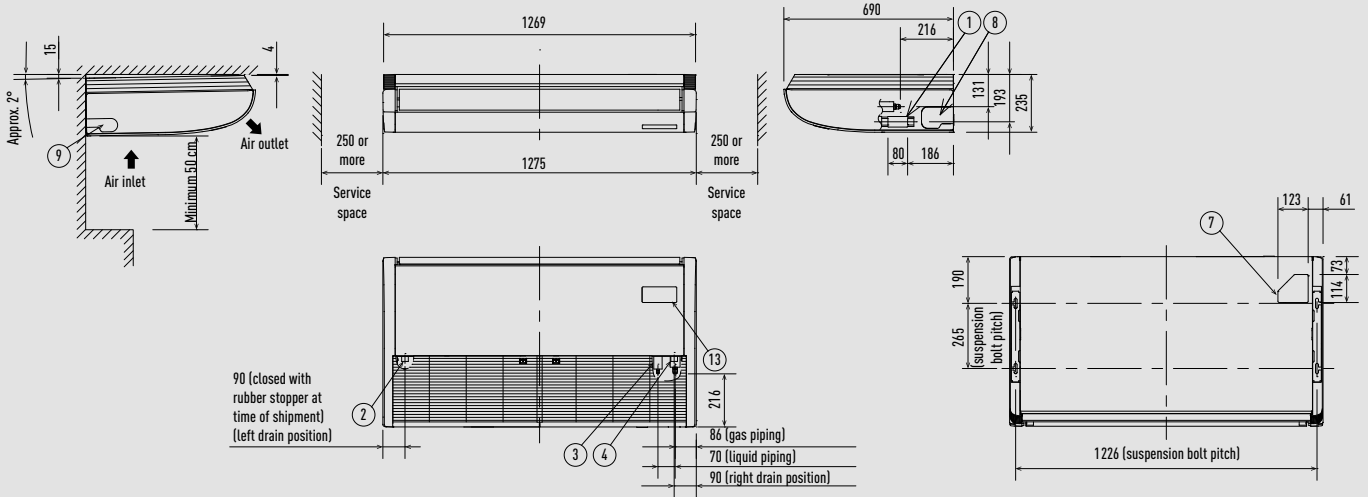

S-106MT2E5A / S-140MT2E5A

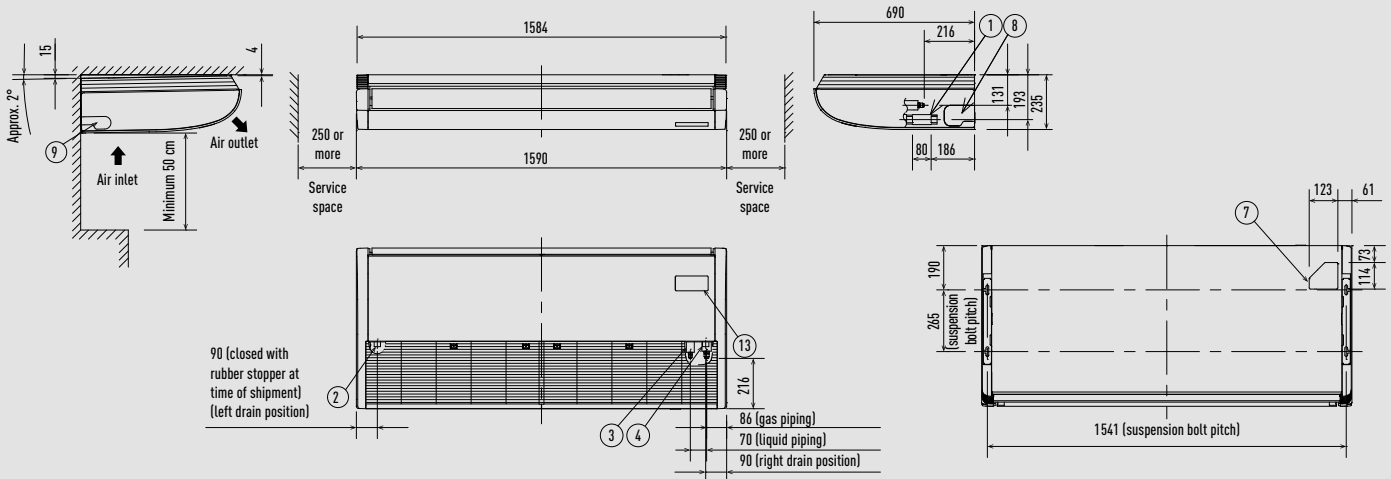

1	Drain piping connection port VP20	Inside diameter 26 mm, drain hose supplied	5	Left side drain hose outlet port (cutout)	
2	Left drain position		6	Piping hole on wall surface	Ø100 mm
3	Refrigerant piping (liquid)	Ø9,52 (flared)	7	Upper side piping port	
4	Refrigerant piping (gas)	Ø15,88 (flared)	8	Right side drain hose outlet port (cutout)	
			9	Wireless remote controller receiver installation location	

G1 type floor console.

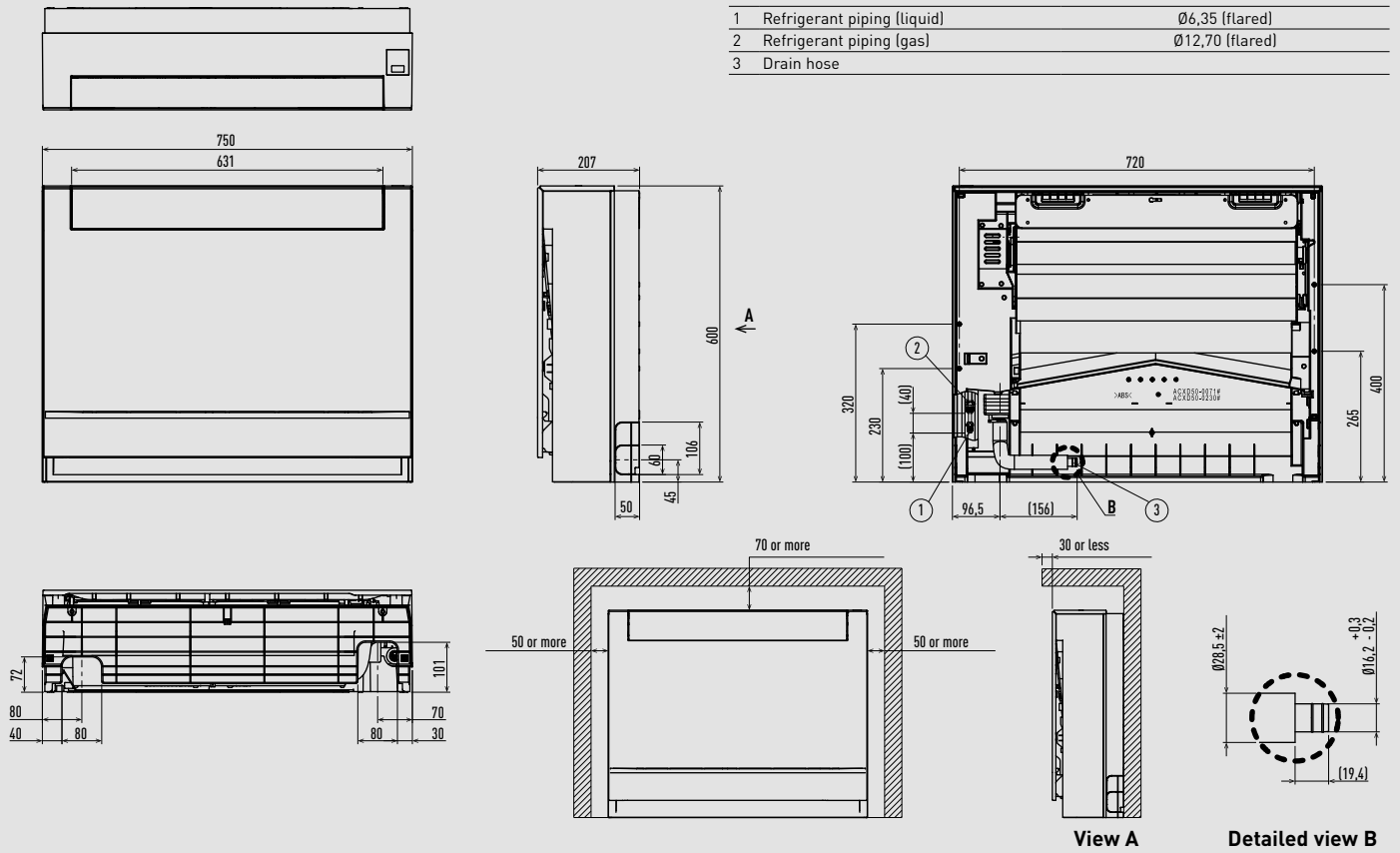

Unit: mm

P1 type floor-standing.

- 1 4- $\varnothing 12$  holes (for fastening the indoor unit to the floor with screws)
- 2 Air filter
- 3 Refrigerant piping (liquid)
- 4 Refrigerant piping (gas)
- 5 Level adjusting bolt
- 6 Drain piping connection port 20 A
- 7 Power cord outlet (downward, rear)
- 8 Refrigerant piping outlet (downward, rear)
- 9 Location for mounting the remote controller (remote controller can be attached within the room)

	A	B	C	Liquid piping	Gas piping
22-36	1065	665	632		
45				$\varnothing 6,35$	$\varnothing 12,70$
56	1380	980	947		
71				$\varnothing 9,52$	$\varnothing 15,88$

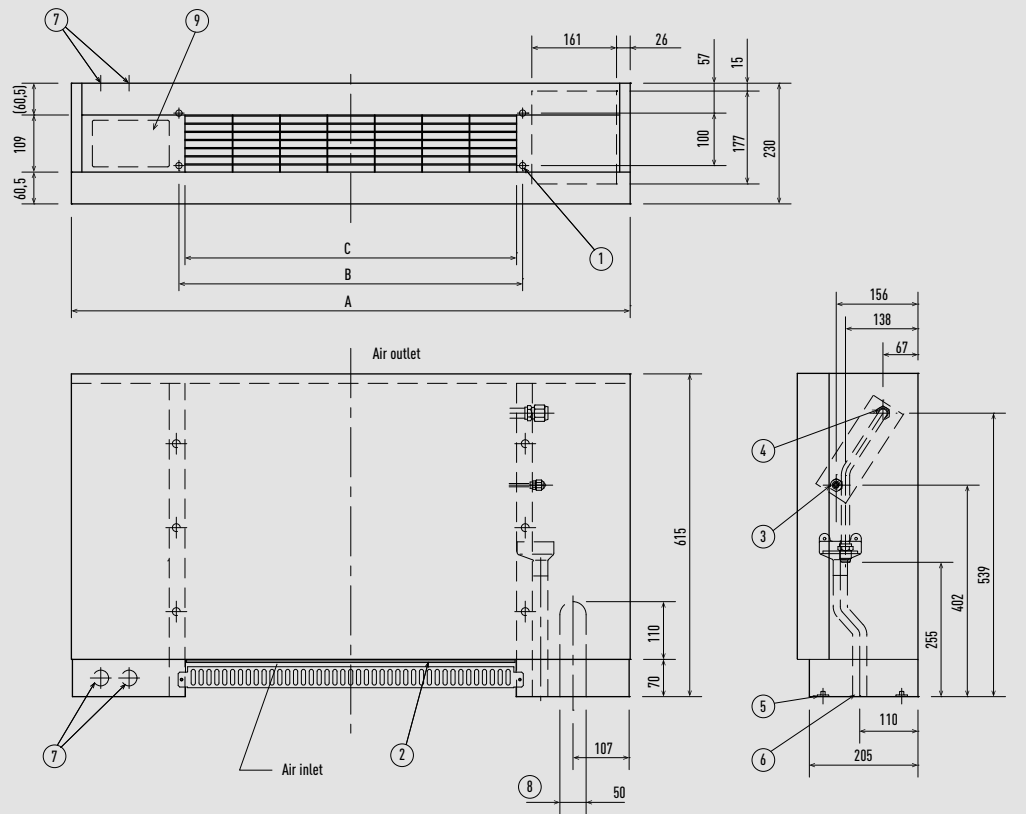

Unit: mm

R1 type concealed floor-standing.

- 1 4-Ø12 holes (for fastening the indoor unit to the floor with screws)
- 2 Air filter
- 3 Refrigerant piping (liquid)
- 4 Refrigerant piping (gas)
- 5 Level adjusting bolt
- 6 Drain piping connection port 20 A
- 7 Flange for the air outlet duct

	22-36	45	56	71
A	904	1219		
B	692	1007		
C	672	1002		
D	665	980		
E	500	900		
F	86	51		
Liquid piping	Ø6,35		Ø9,52	
Gas piping	Ø12,70		Ø15,88	

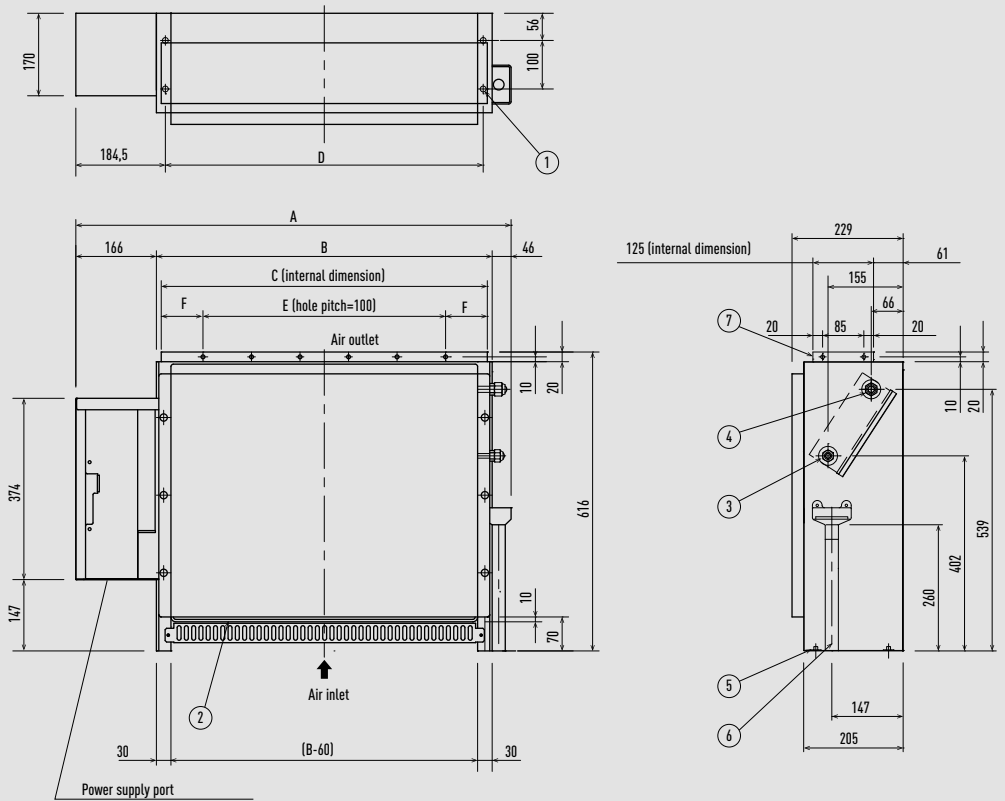

Unit: mm

Hydrokit for ECOi, water at 45 °C.

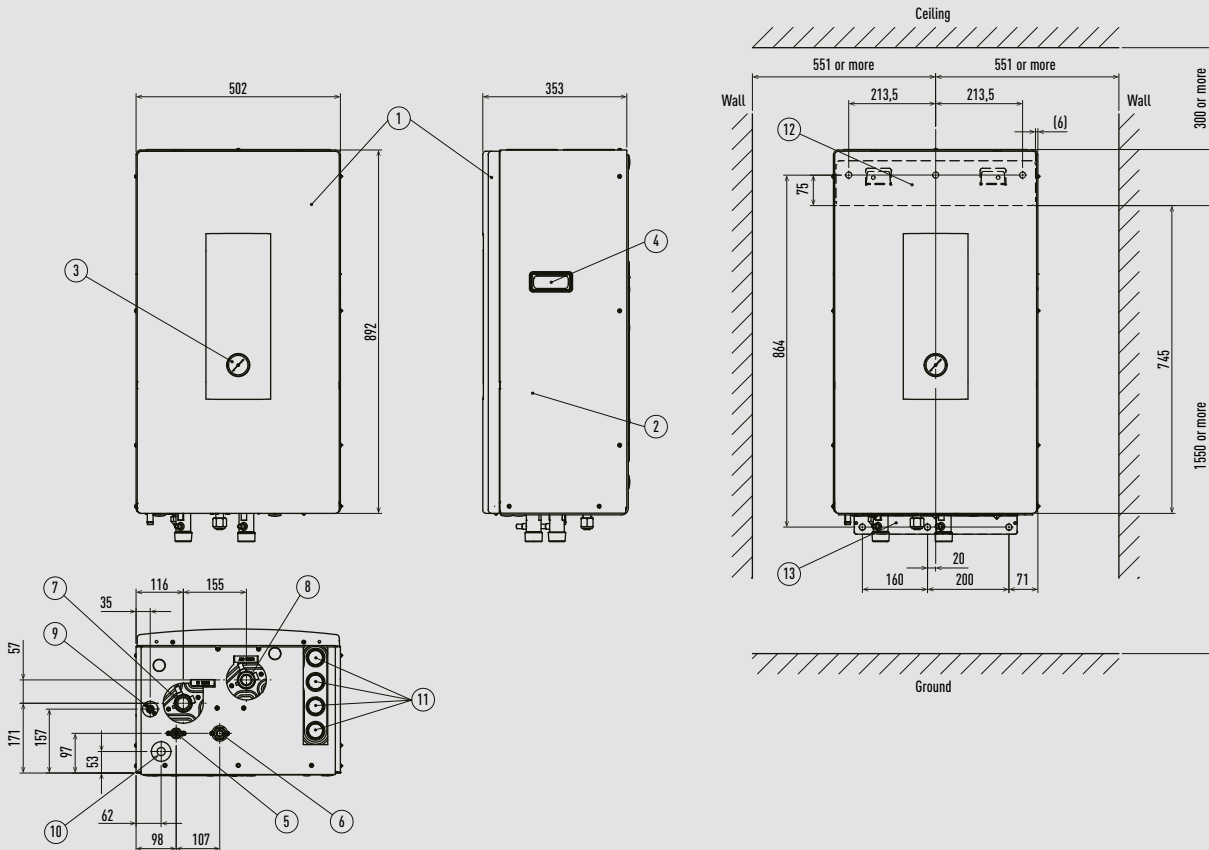

Unit: mm

AHU connection kit for PACi, ECOi and ECO G.

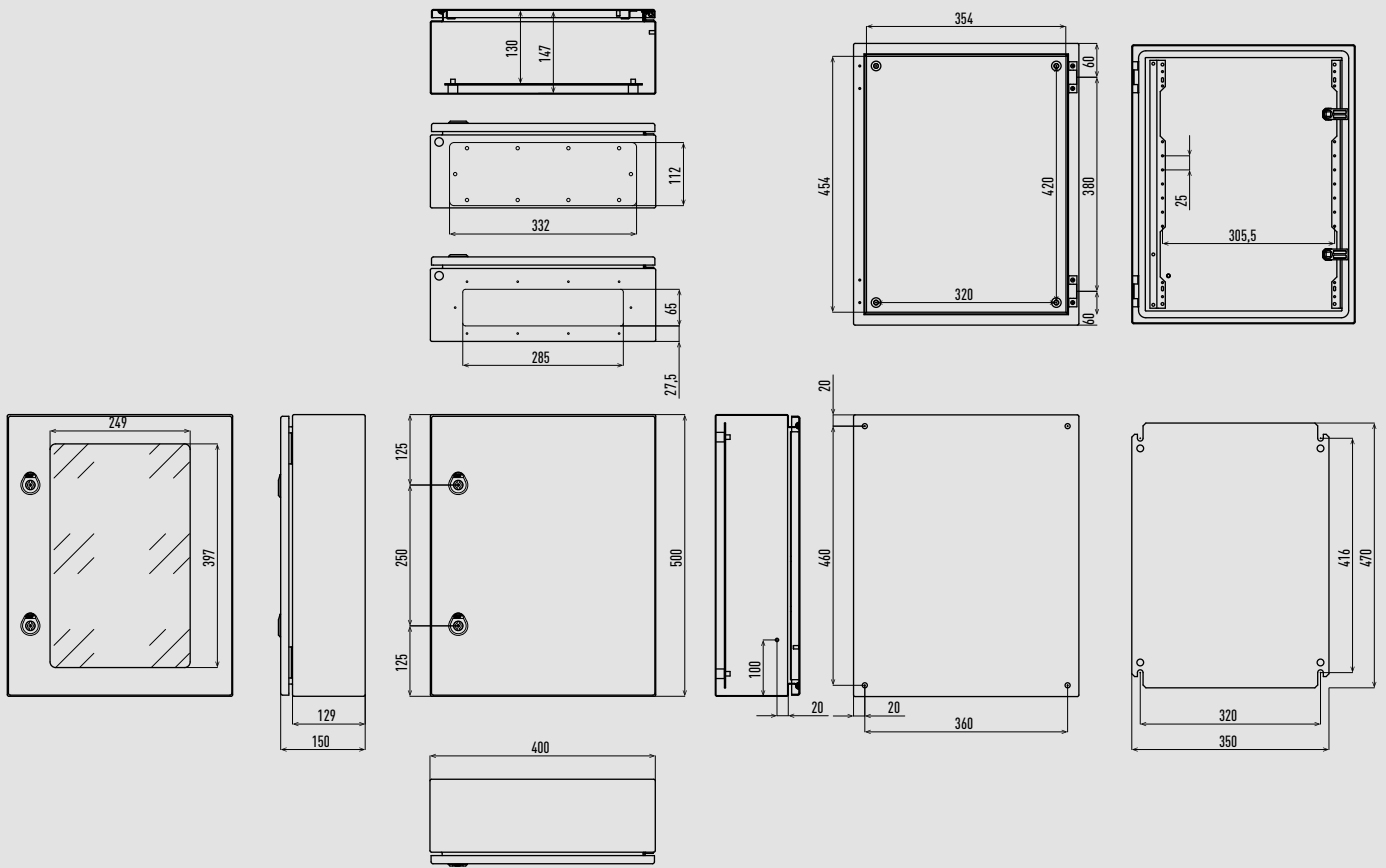

Unit: mm

Advanced energy recovery ventilation - ZY Series.

FV-15ZY1G / FV-25ZY1G / FV-35ZY1G / FV-50ZY1G / FV-65ZY1G / FV-80ZY1G / FV-1KZY1G

	A	B	C	D	E	F	G	H	J	K	L	M	N	Duct diameter
<b>FV-15ZY1G</b>	860	666	786	610	289	144,5	102	Ø97,6	Ø150	395	107,5	116	168	Ø100
<b>FV-25ZY1G</b>	860	791	786	735	289	144,5	102	Ø145	Ø200	470	132,5	116	168	Ø150
<b>FV-35ZY1G</b>	968	930	895	874	331	165,5	102	Ø145	Ø200	609	132,5	115	168	Ø150
<b>FV-50ZY1G</b>	968	1072	895	1016	331	165,5	114	Ø195	Ø250	665	175,5	115	168	Ø200
<b>FV-65ZY1G</b>	1008	1010	934	954	404	202	114	Ø195	Ø250	638	158	121	168	Ø200
<b>FV-80ZY1G</b>	1224	1060	1148	1004	404	202	122	Ø245	Ø300	633	185,5	121	168	Ø250
<b>FV-1KZY1G</b>	1224	1287	1148	1231	404	202	122	Ø245	Ø300	860	185,5	121	168	Ø250

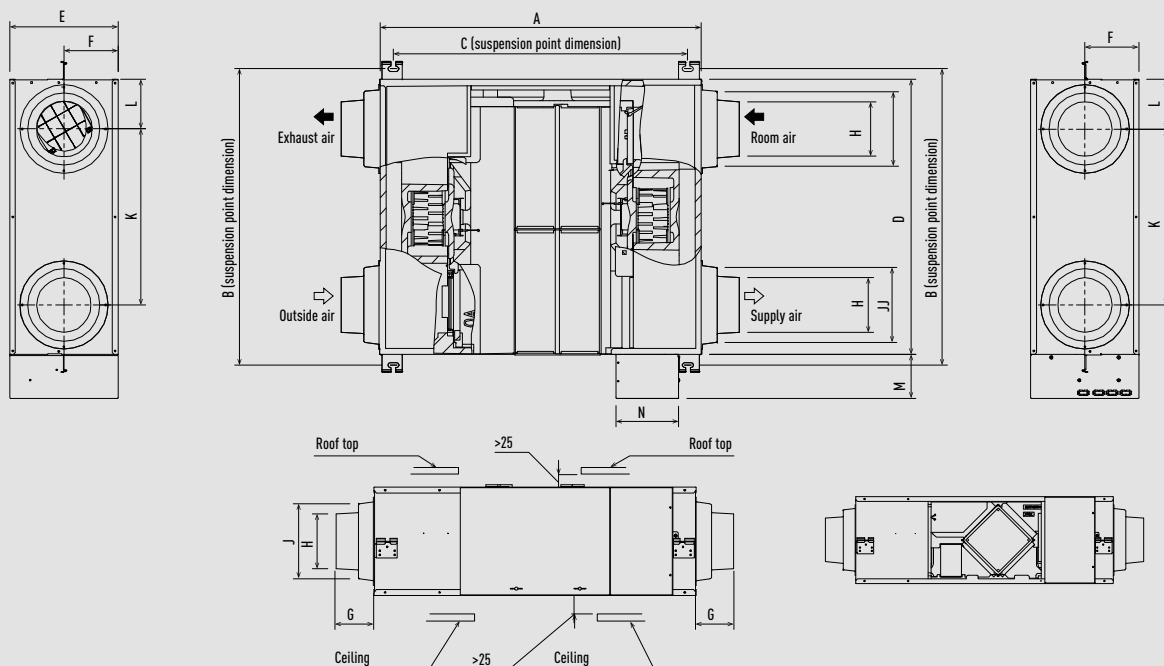

Unit: mm



Advanced energy recovery ventilation - ZY Series.

FV-1HZY1G / FV-2KZY1G

	A	B	C	D	E	F	G	H	J	K	L	M	N	Duct diameter
FV-1HZY1G	1224	1141	1127	1004	808	202	122	Ø245	Ø300	663	185.5	121	168	Ø250
FV-2KZY1G	1224	1368	1127	1231	808	202	122	Ø245	Ø300	860	185.5	121	168	Ø250

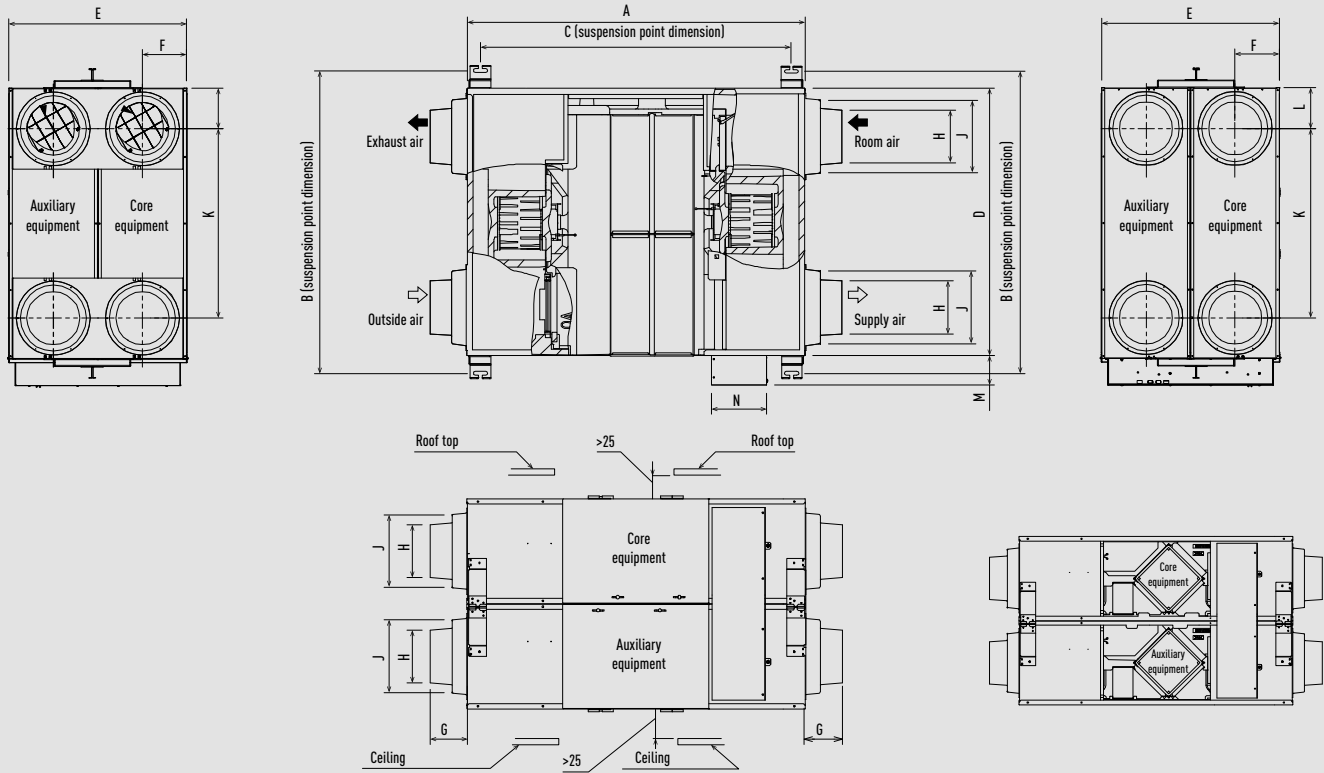

Unit: mm

ERV with DX coil - HRPT Series - PAW-HRPT40HX.

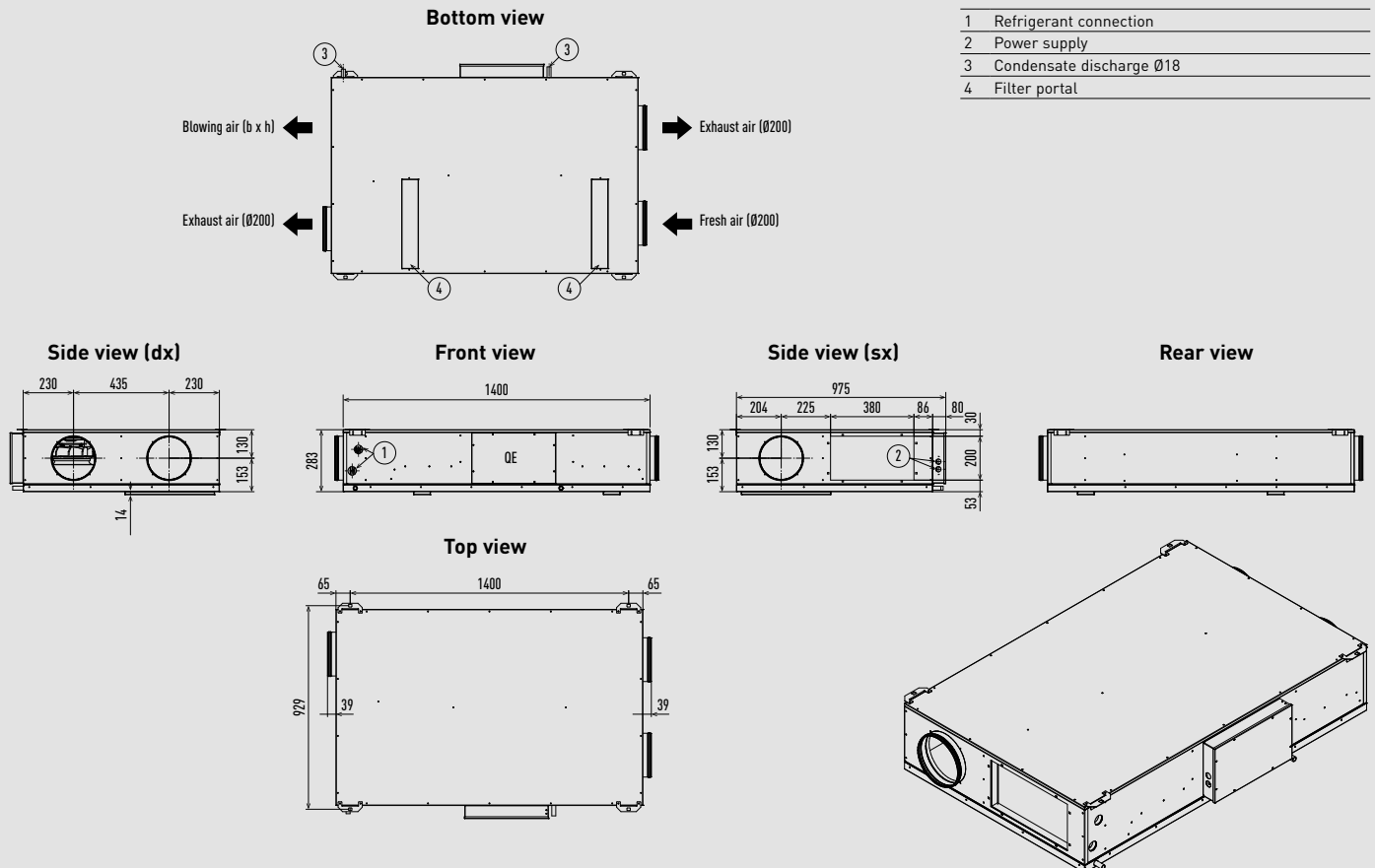

Unit: mm

ERV with DX coil - HRPT Series - PAW-HRPT80HX / PAW-HRPT120HX / PAW-HRPT160HX / PAW-HRPT200HX.

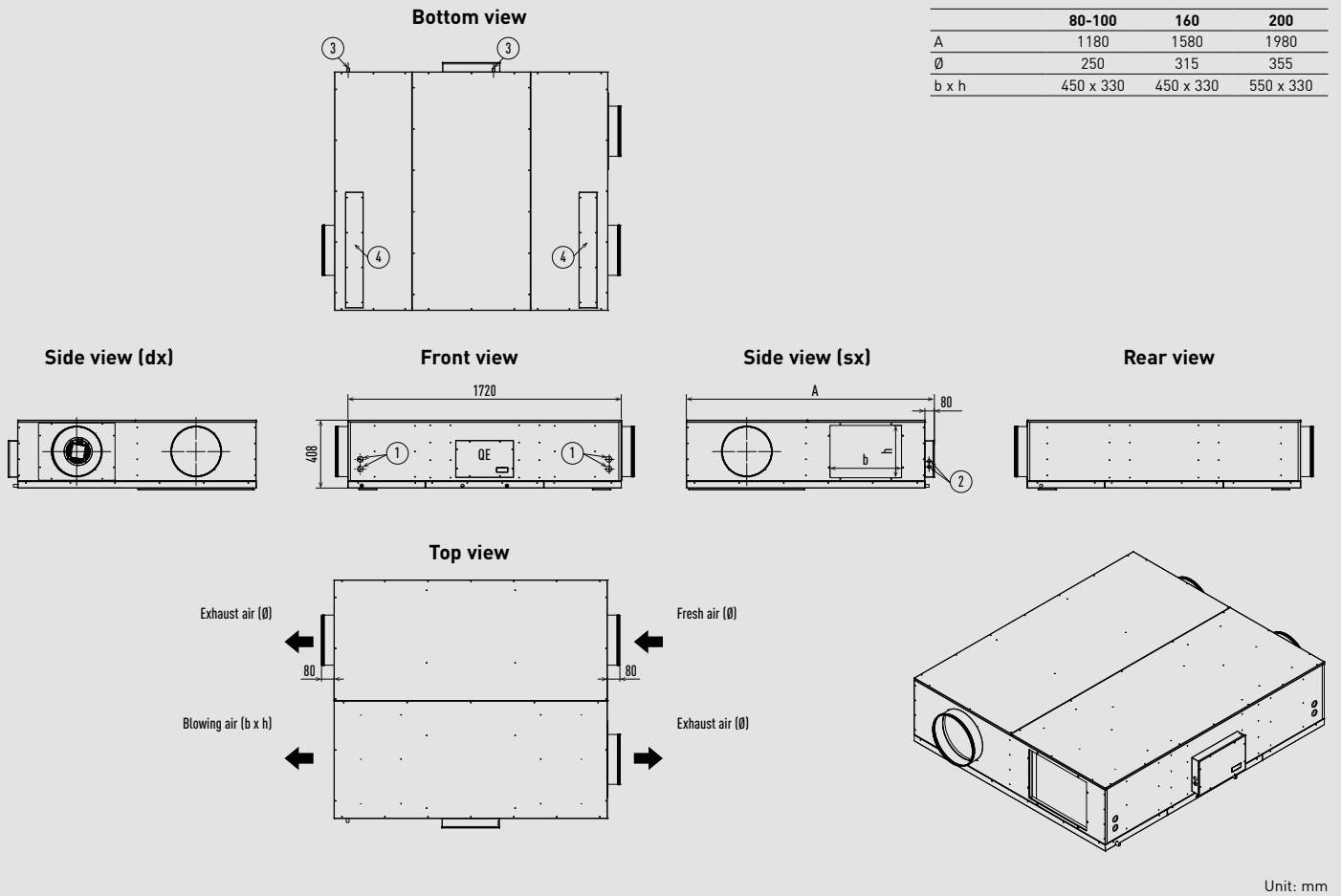

ERV with DX coil - HRPT Series - PAW-HRPT40HX.

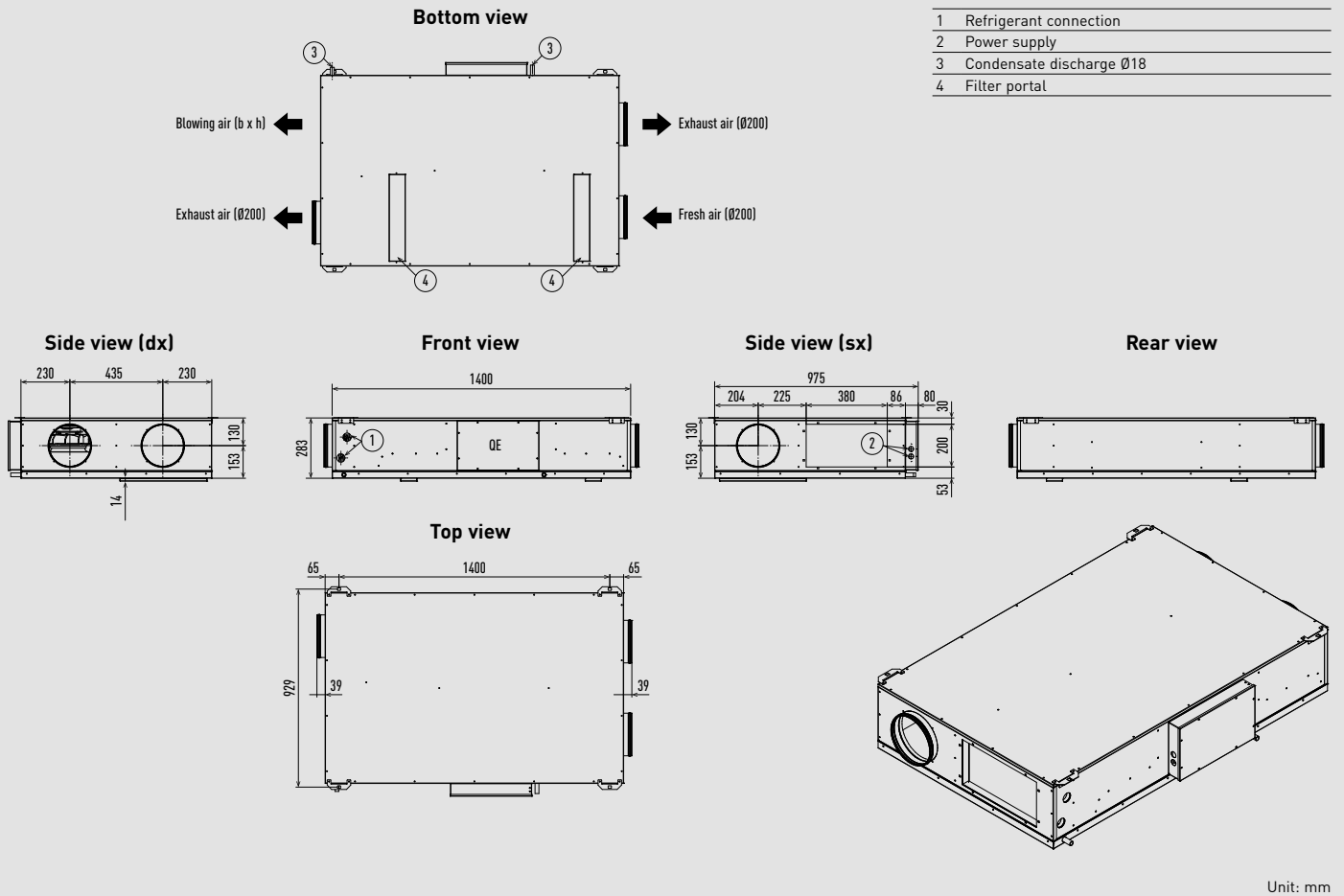

ERV with DX coil - HRPT Series - PAW-HRPT80HX / PAW-HRPT120HX / PAW-HRPT160HX / PAW-HRPT200HX.

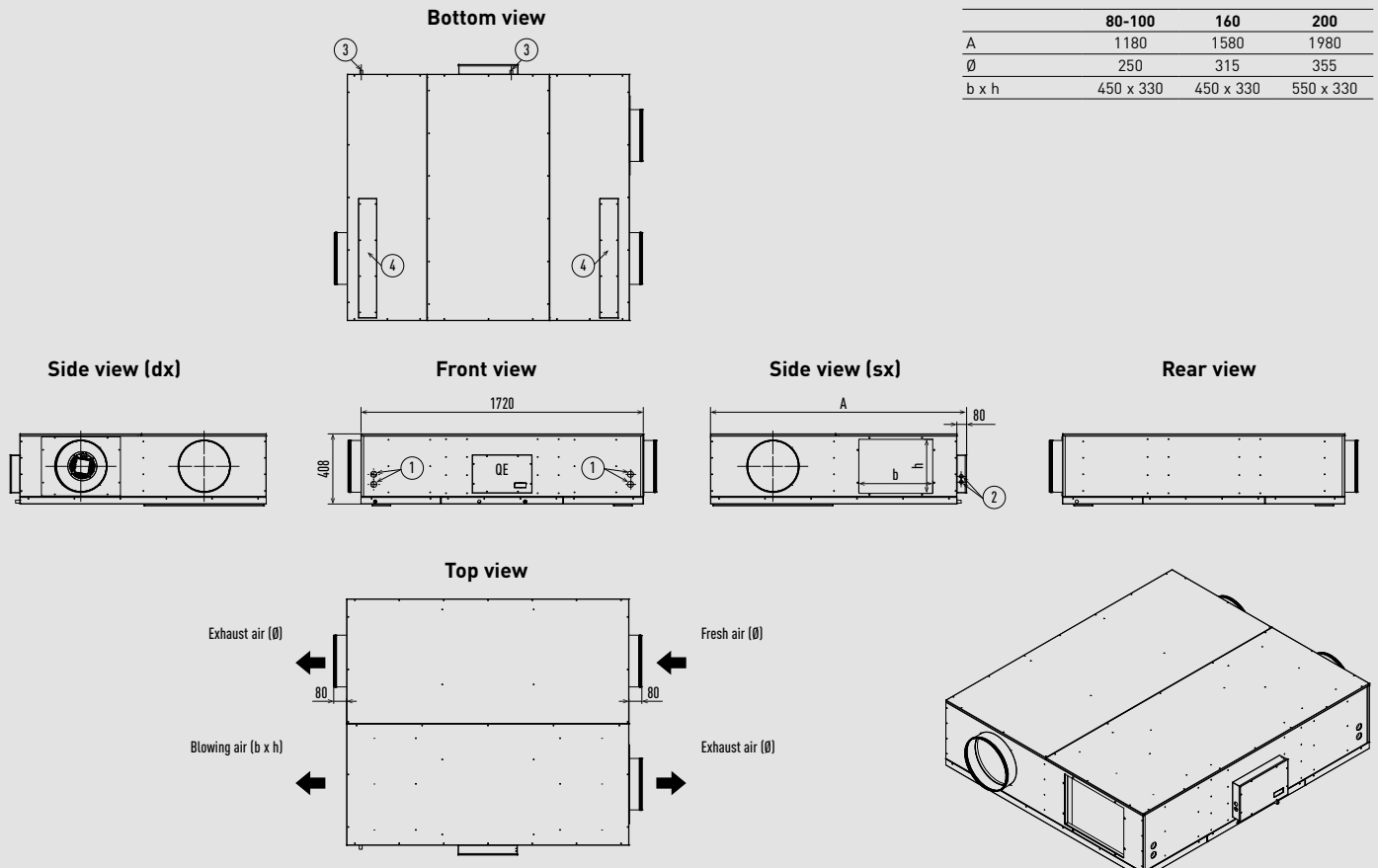

	80-100	160	200
A	1180	1580	1980
Ø	250	315	355
b x h	450 x 330	450 x 330	550 x 330

Unit: mm

Electric air curtain.

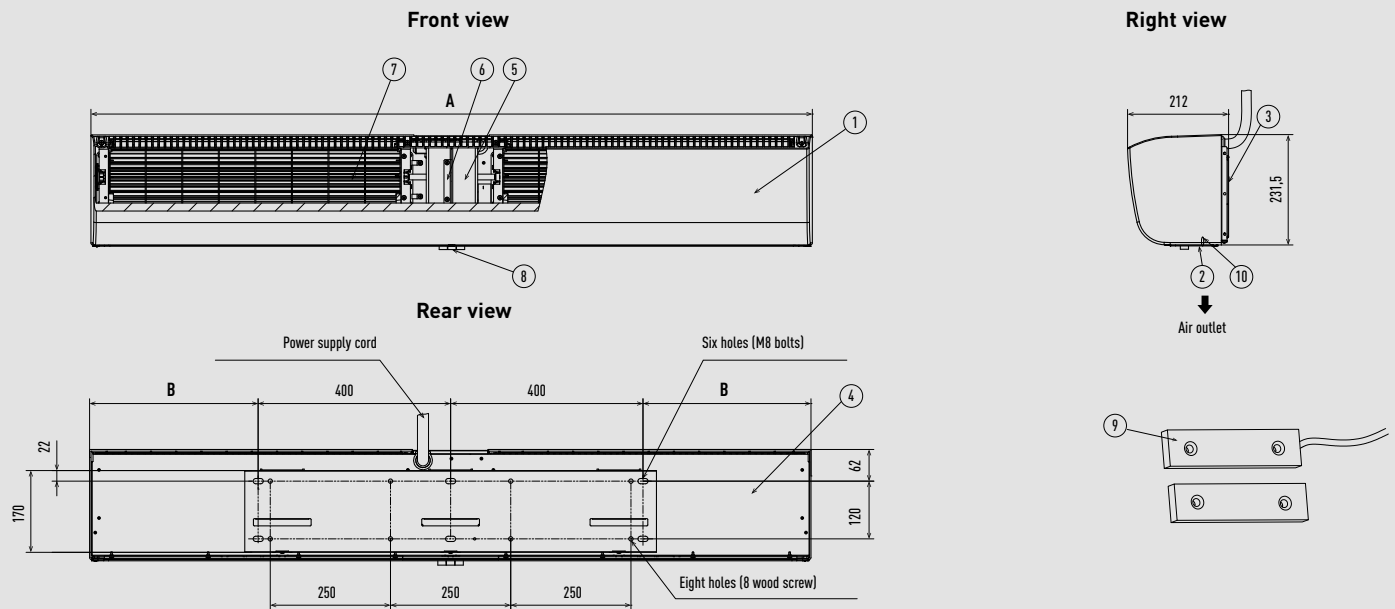

1	Front panel
2	Air outlet
3	Mounting plate
4	Back panel
5	Motor

6	Motor support
7	Cross-flow impeller
8	Push-button switch
9	Gate magnetic switch
10	Guide plate

	FY-3009U1	FY-3012U1	FY-3015U1
A	900	1200	1500
B	50	200	350

Unit: mm

Air curtain with DX coil.

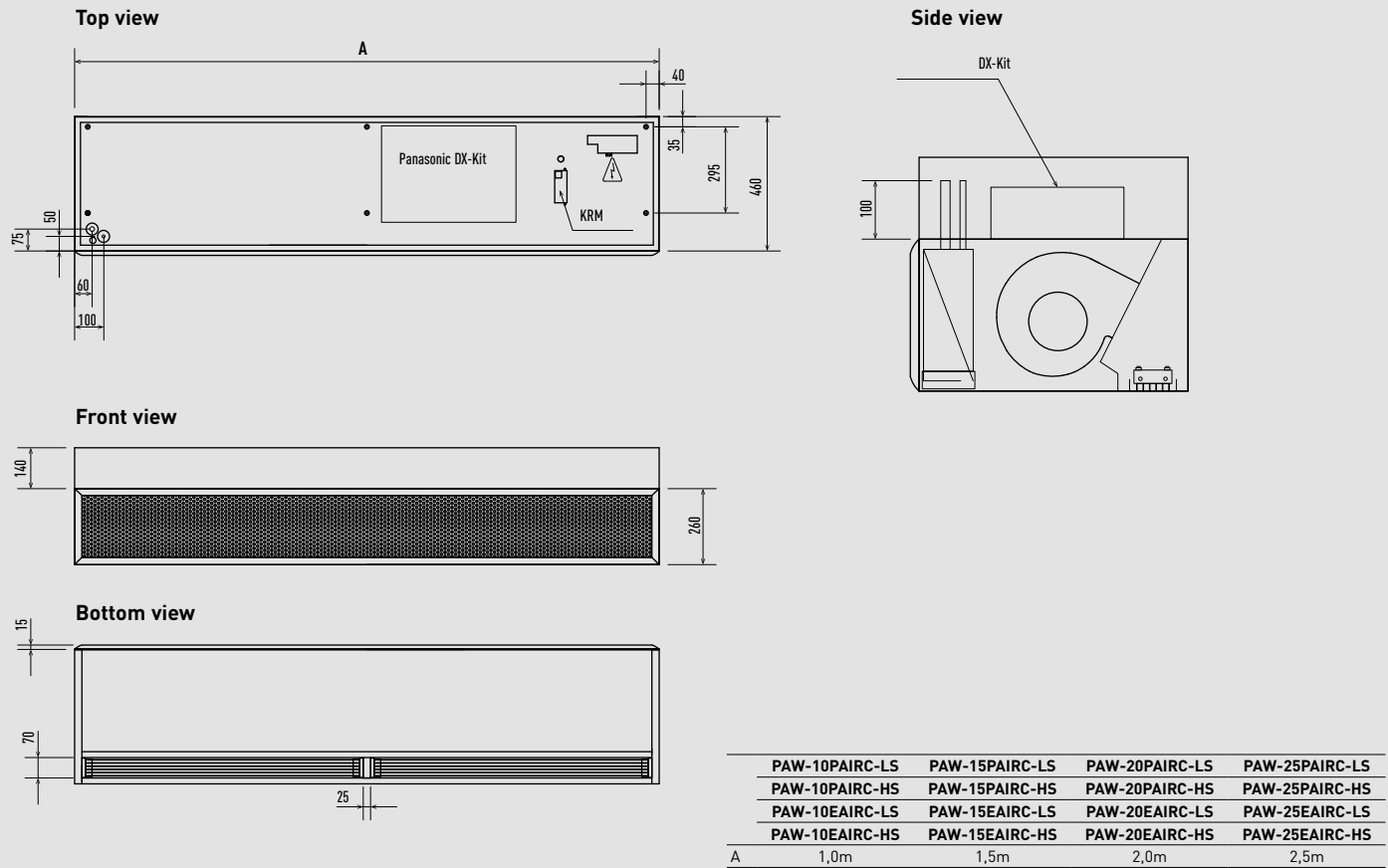

Unit: mm

E2 type high static pressure hide-away.

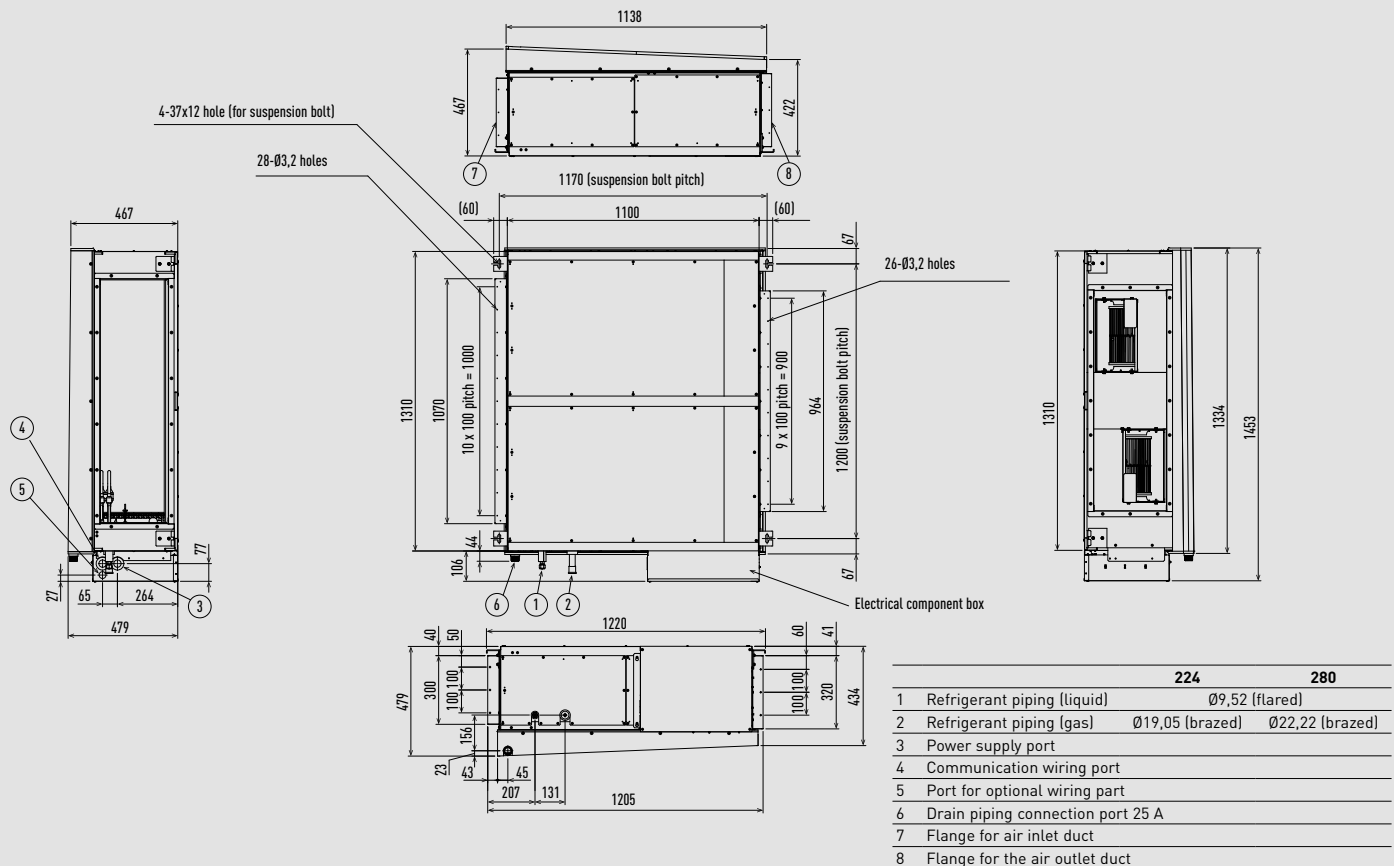

Unit: mm

Ceiling mounted air-e nanoe X Generator.

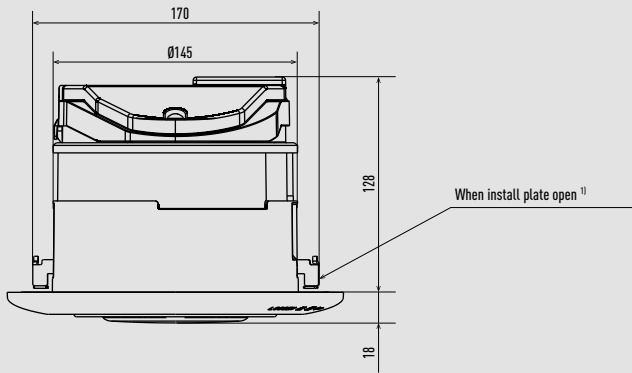

	Quantity
1 Louvre	1
2 Frame	1
3 Electric case assy	1
4 Motor	1
5 Fan	1
6 Orifice assy	1
7 nanoe™ X unit	1
8 Install screw	2
9 Install plate	2

1) Initial position of install plate is closed.

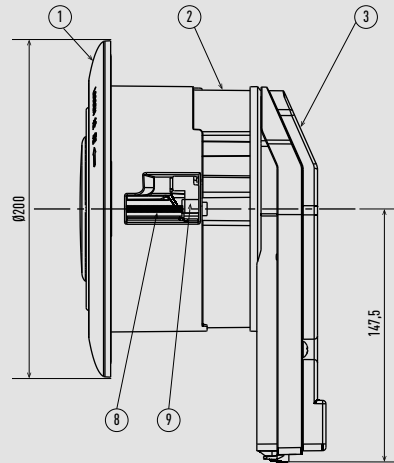
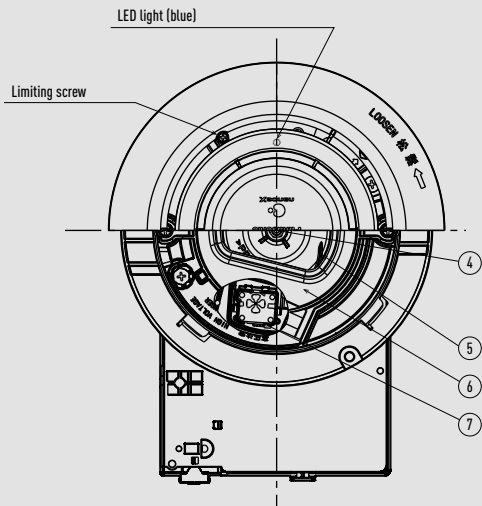

Unit: mm

Heat recovery ventilation unit.

Side view

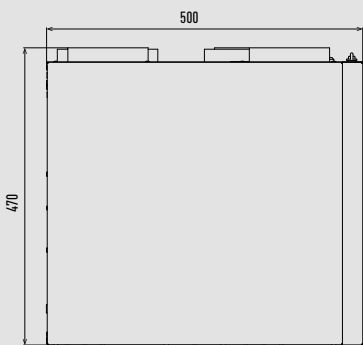

PAW-A2W-VENTA-L

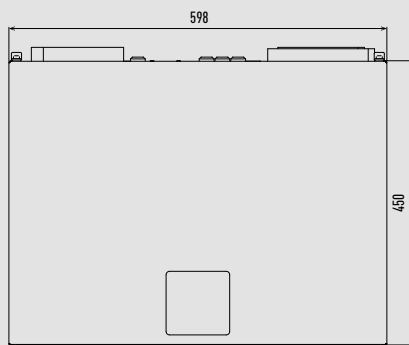

PAW-A2W-VENTA-R

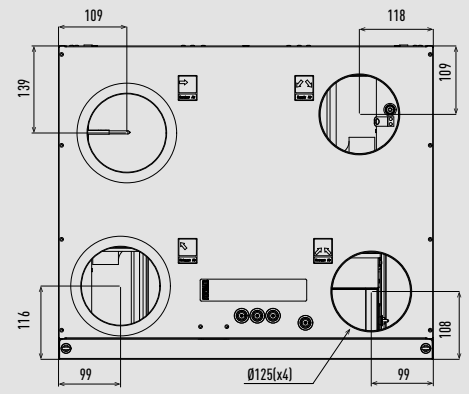
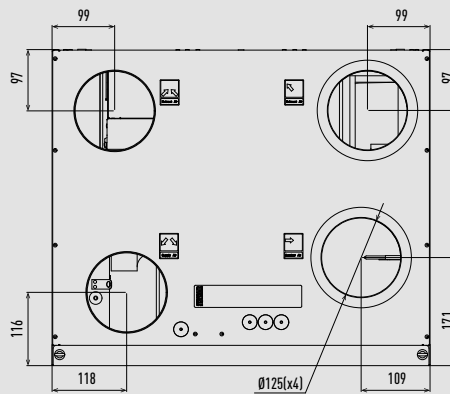
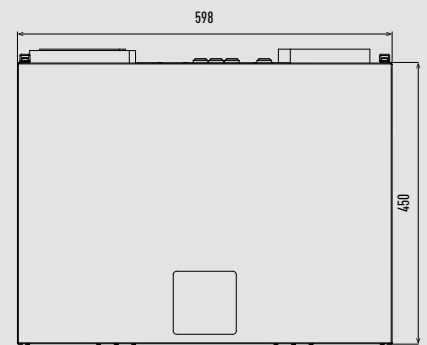

Unit: mm

### Room controller for SE8000.

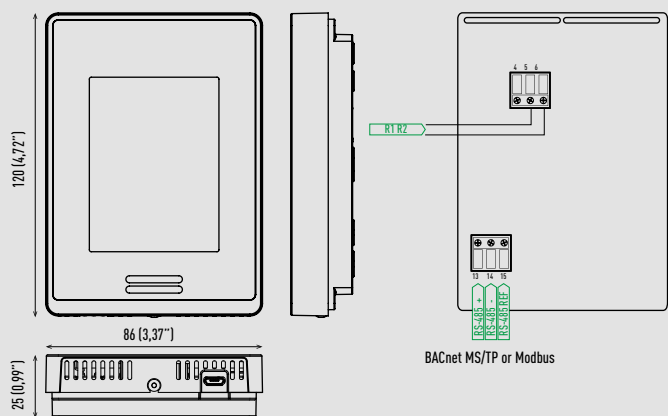

Check with your local government for instruction on disposal of these products.

THIS PRODUCT FOR COMMERCIAL USE ONLY.



**Dimensions:**  
 Height: 12 cm/4,72 in.  
 Width: 8,6 cm/3,39 in.  
 Depth: 2,7 cm/1,06 in.

**Power requirements:**  
 16 V DC from Panasonic R-R IDU connectors.  
 50/60 Hz, 4 VA, Class 2 Supply.

**Range from indoor unit:**  
 Recommended 500 ft (150 m).

**Operating conditions:**  
 0 °C to 50 °C [32 °F to 122 °F].  
 0% to 95% R.H. non-condensing.

**Storage conditions:**  
 -30 °C to 50 °C [-22 °F to 122 °F].  
 0% to 95% R.H. non-condensing.

**Temperature sensor:**  
 Local 10 K NTC type 2 thermistor.

**Temperature sensor resolution:**  
 ± 0,1 °C (± 0,2 °F).

**Temperature sensor accuracy:**  
 ± 0,5 °C (± 0,9 °F) @ 21 °C (70 °F) typical calibrated.

**Humidity sensor and calibration:**  
 Single point calibrated bulk polymer type sensor.

**Humidity sensor precision:**  
 Reading range from 10% to 90% R.H. non-condensing.  
 10% to 20% precision: 10%.  
 20% to 80% precision: 5%.  
 80% to 90% precision: 10%.

**Humidity sensor stability:**  
 Less than 1,0% yearly (typical drift).

**Wiring:**  
 Maximum wire length between last indoor unit to SER8150Rx B1194 equals 490 ft (150 m) with AWG #18 wire (0,82 mm<sup>2</sup>). Refer to Panasonic VRF guidelines "Wiring system diagram for remote controller" for this limitation.

**Approximate shipping weight:**  
 0,34 kg (0,75 lb)

Unit: mm

### SED-MTH-G-5045 wall/ceiling wireless sensor.

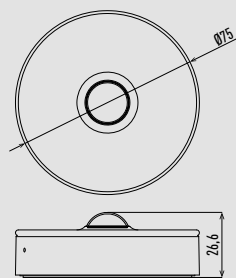

**Dimensions:**  
 70 mm diameter x 26,6 mm.

**Colour:**  
 White.

**Weight:**  
 59 g.

**Communication:**  
 ZigBee 3,0 HA.

**Detection range:**  
 Ceiling: Ø4m (installation height 2,5 m).  
 Wall: R5m (installation height 1,2 m).

**Battery voltage:**  
 3 V.

**Battery cell:**  
 LR03 AAA (2 pcs).

**Battery life:**  
 Up to 5 years.

**Ambient temperature:**  
 -10 °C ~ +50 °C.



Check with your local government for instruction on disposal of these products.

### SED-WDC-G-5045 door/window wireless sensor.

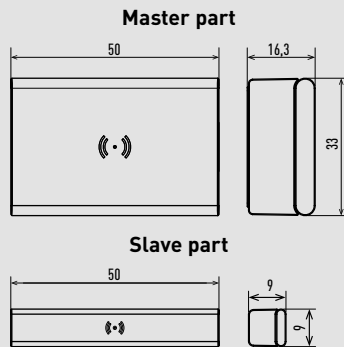

**Dimensions:**  
 Master part: 50 x 33 x 16,3 mm.  
 Slave part: 50 x 9 x 9 mm.

**Colour:**  
 White / transparent.

**Weight:**  
 30 g

**Communication:**  
 ZigBee 3,0 HA.

**Detection range:**  
 Trigger 'close': wood 30 mm, metal 18 mm.  
 Trigger 'open': wood 32 mm, metal 20 mm.

**Battery voltage:**  
 3 V.

**Battery cell:**  
 CR2450.

**Battery life:**  
 Up to 5 years.

**Ambient temperature:**  
 -10 °C ~ +50 °C.



Check with your local government for instruction on disposal of these products.

Unit: mm

SED-CO2-G-5045 CO<sub>2</sub> sensor.

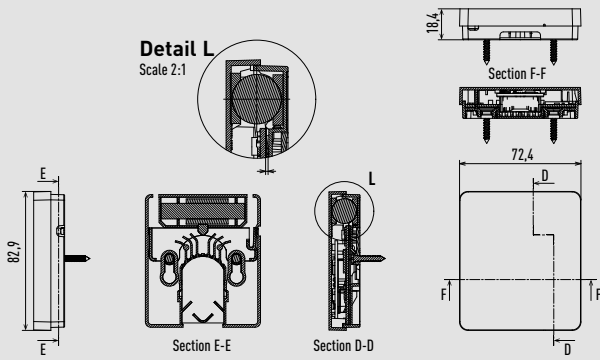

Certification



Check with your local government for instruction on disposal of these products.

**Dimensions:**

3,26 x 2,85 x 0,72 inches.  
82,9 x 72,4 x 18,4 mm.

**Operating temperature:**

0 °C to 50 °C (32 °F to 122 °F).

**Temperature accuracy:**

±0,3 °C (0,54 °F) typical within operating range.

**Humidity range:**

0% to 100%.

**Humidity accuracy:**

± 3% RH (typical within 0% to 80% RH).

**Measurement range:**

0 to 5000ppm.

**Measurement/Transmission intervals:**

2,5 minutes (day), 10 minutes (evening).  
Note: Battery life will be reduced should interval be shortened (i.e, using remote temperature/humidity functions).

**CO<sub>2</sub> accuracy at NTP:**

±60 ppm +3% of reading (400 - 2,000 ppm range).

**Communication:**

Zigbee 3,0 Green Power (encrypted, bi-directional).

**Battery voltage:**

3,6 V.

**Battery cell:**

AA Lithium ion.

**Battery life:**

10+ years (non-replaceable).  
Note: Battery life can be reduced when sensor is operated at temperatures approaching the operating limits.

**Ambient temperature:**

-30 °C to 70 °C.

Unit: mm

CZ-CAPWFC2 Commercial Wi-Fi Adaptor.

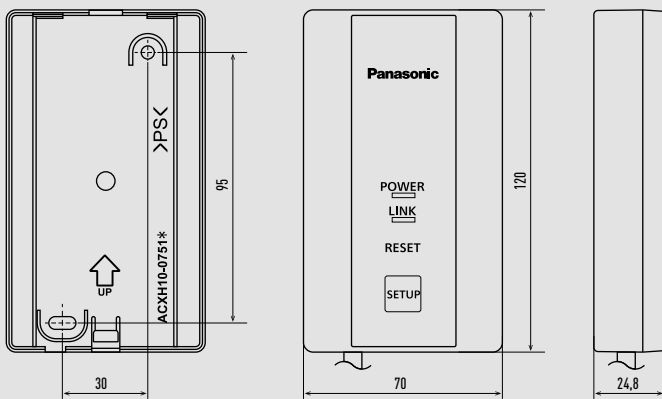

CZ-RTC6W/WBL/WBLW2 and CZ-RTC6/BL/BLW2 CONEX wired remote controller.

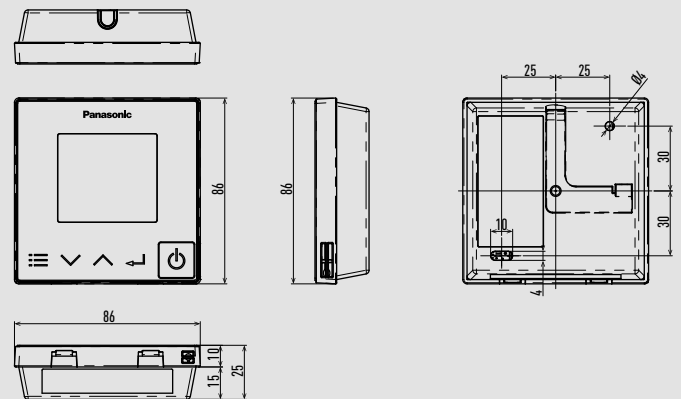

CZ-RTC5B design wired remote controller.

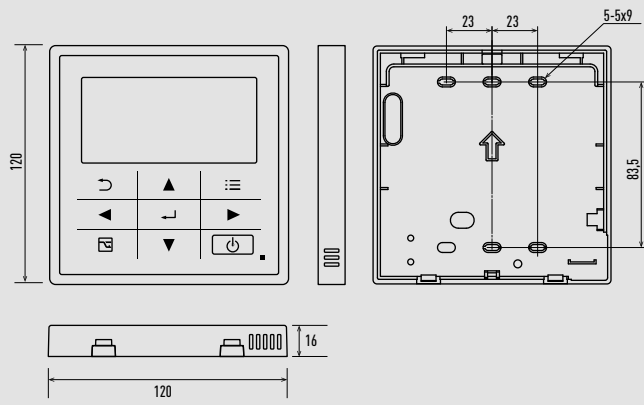

CZ-256ESMC3 intelligent controller (touch screen/web server).

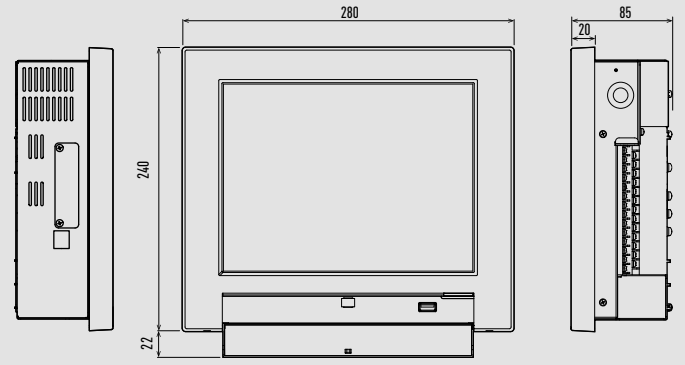

CZ-CENSC1 Econavi sensor.

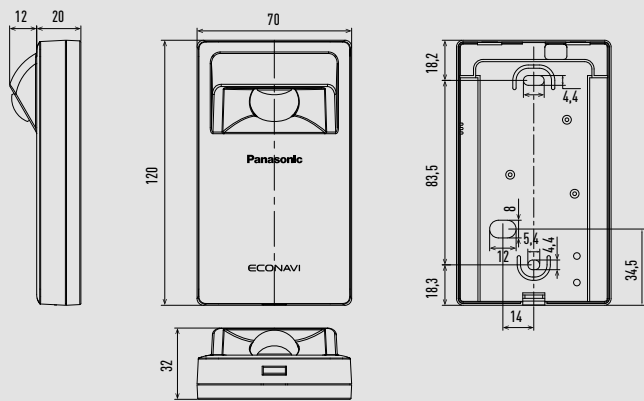

CZ-RWS3 infrared remote controller.

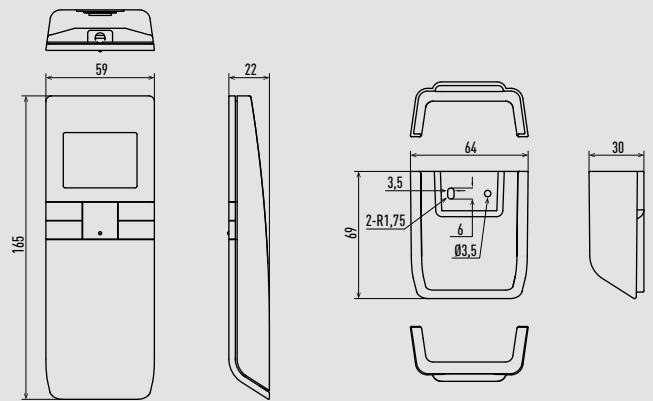

CZ-CSRC3 remote sensor.

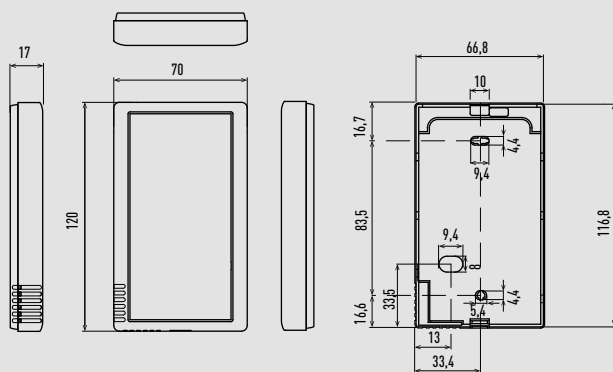

Unit: mm



CZ-64ESMC3 system controller with weekly timer.

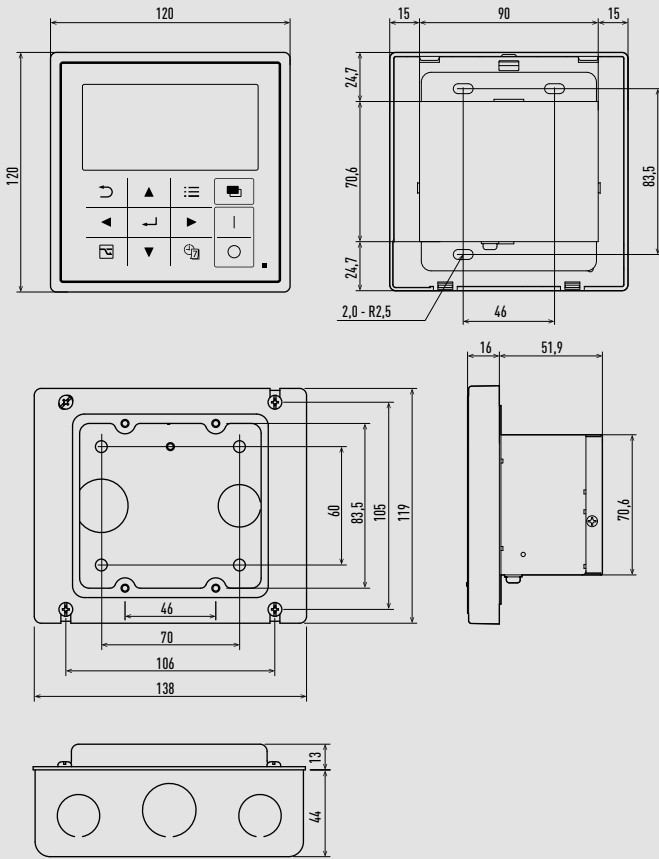

CZ-ANC3 central ON / OFF controller.

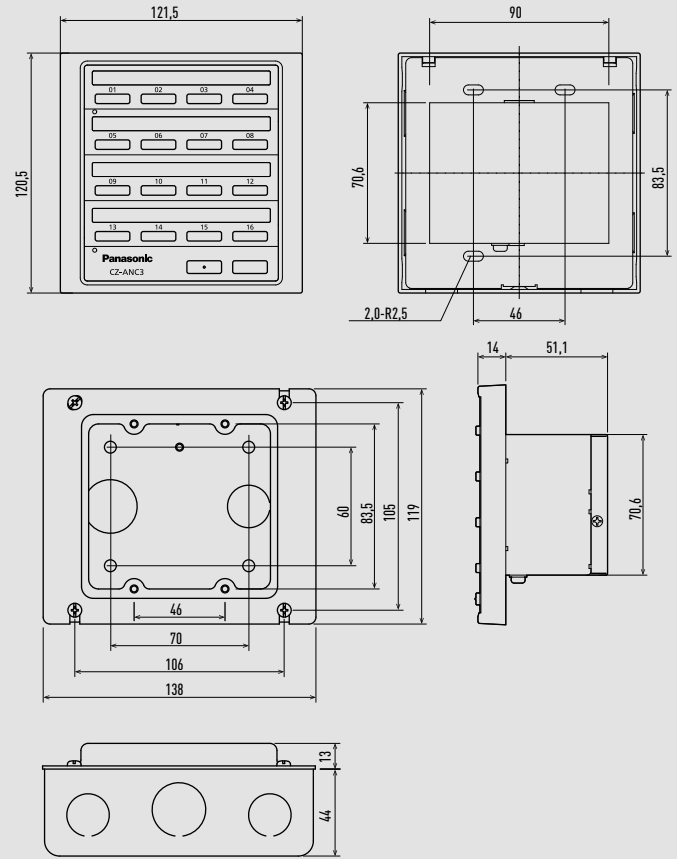

CZ-CAPC3 local adaptor for ON / OFF control.

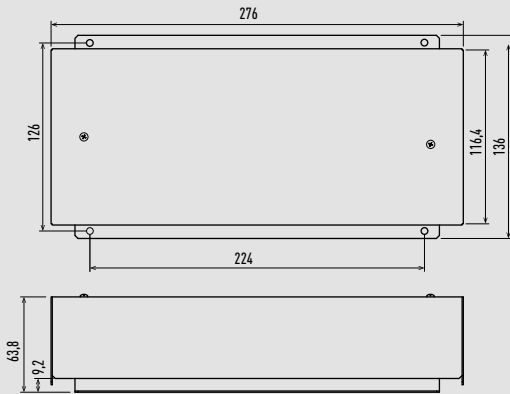

CZ-CAPBC2 Mini Seri-Para I/O Unit 0 - 10 V.

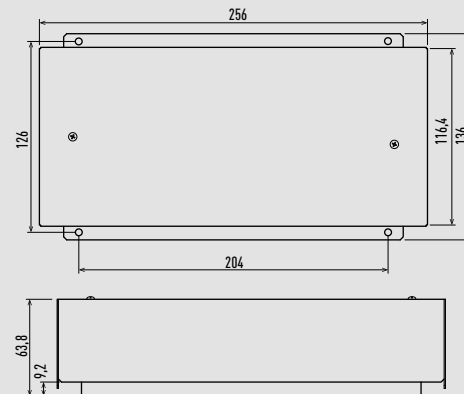

CZ-CFUNC2 communication adaptor.

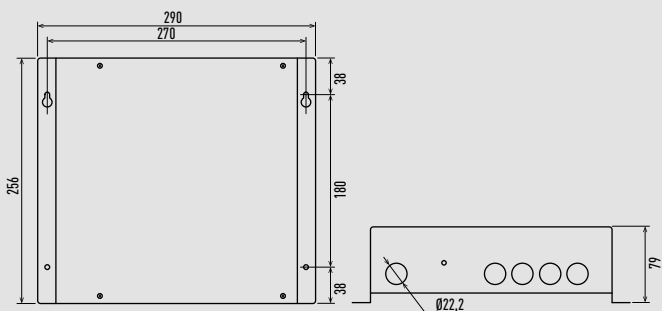

CO<sub>2</sub> condensing units - CR Series OCU-CR200VF5A / OCU-CR200VF5ASL.

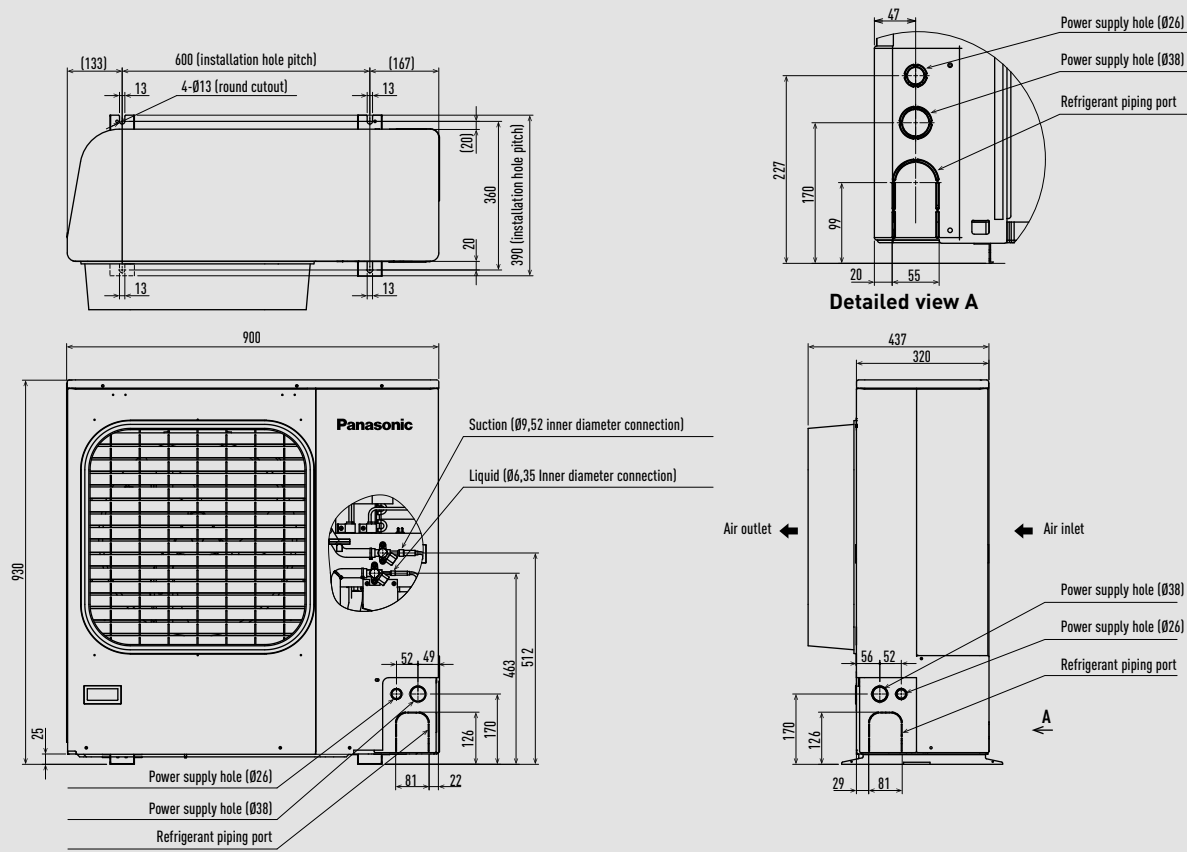

Unit: mm

CO<sub>2</sub> condensing units - CR Series OCU-CR400VF8 / OCU-CR400VF8SL / OCU-CR400VF8A / OCU-CR400VF8ASL.

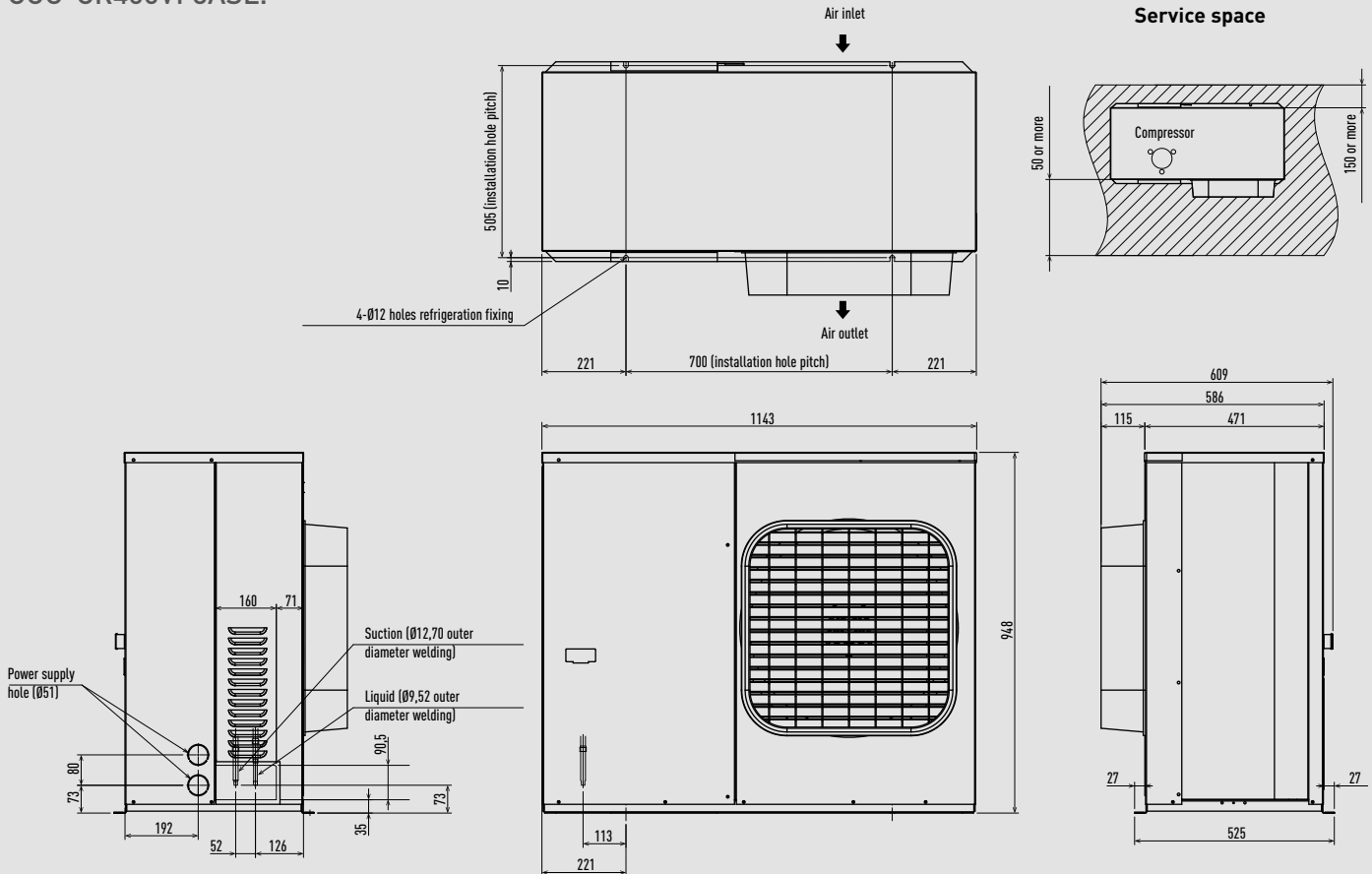

Unit: mm

CO<sub>2</sub> condensing units - CR Series OCU-CR1000VF8 / OCU-CR1000VF8SL / OCU-CR1000VF8A / OCU-CR1000VF8ASL.

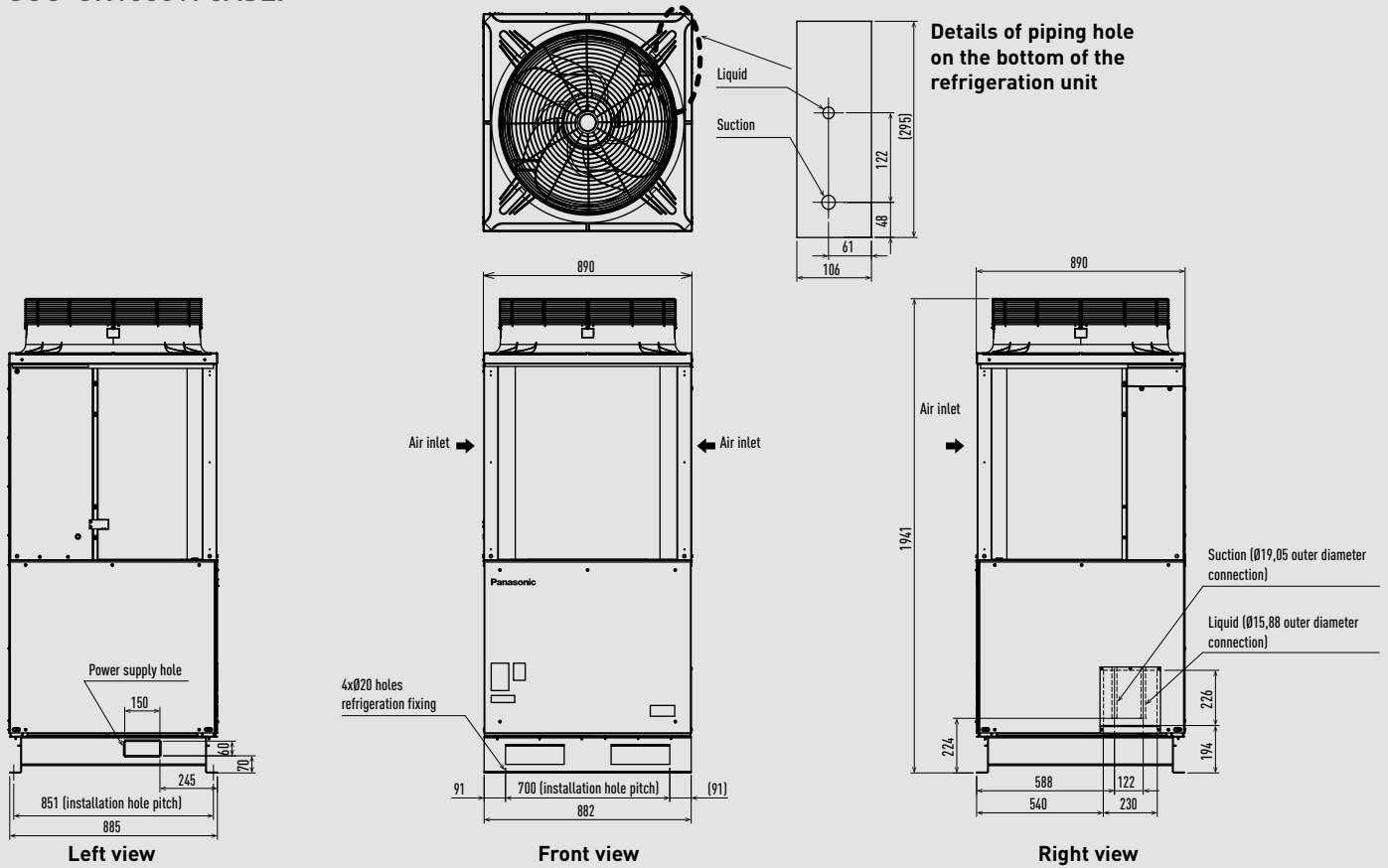

Unit: mm

CO<sub>2</sub> condensing units - CR Series OCU-CR2000VF8A / OCU-CR2000VF8ASL.

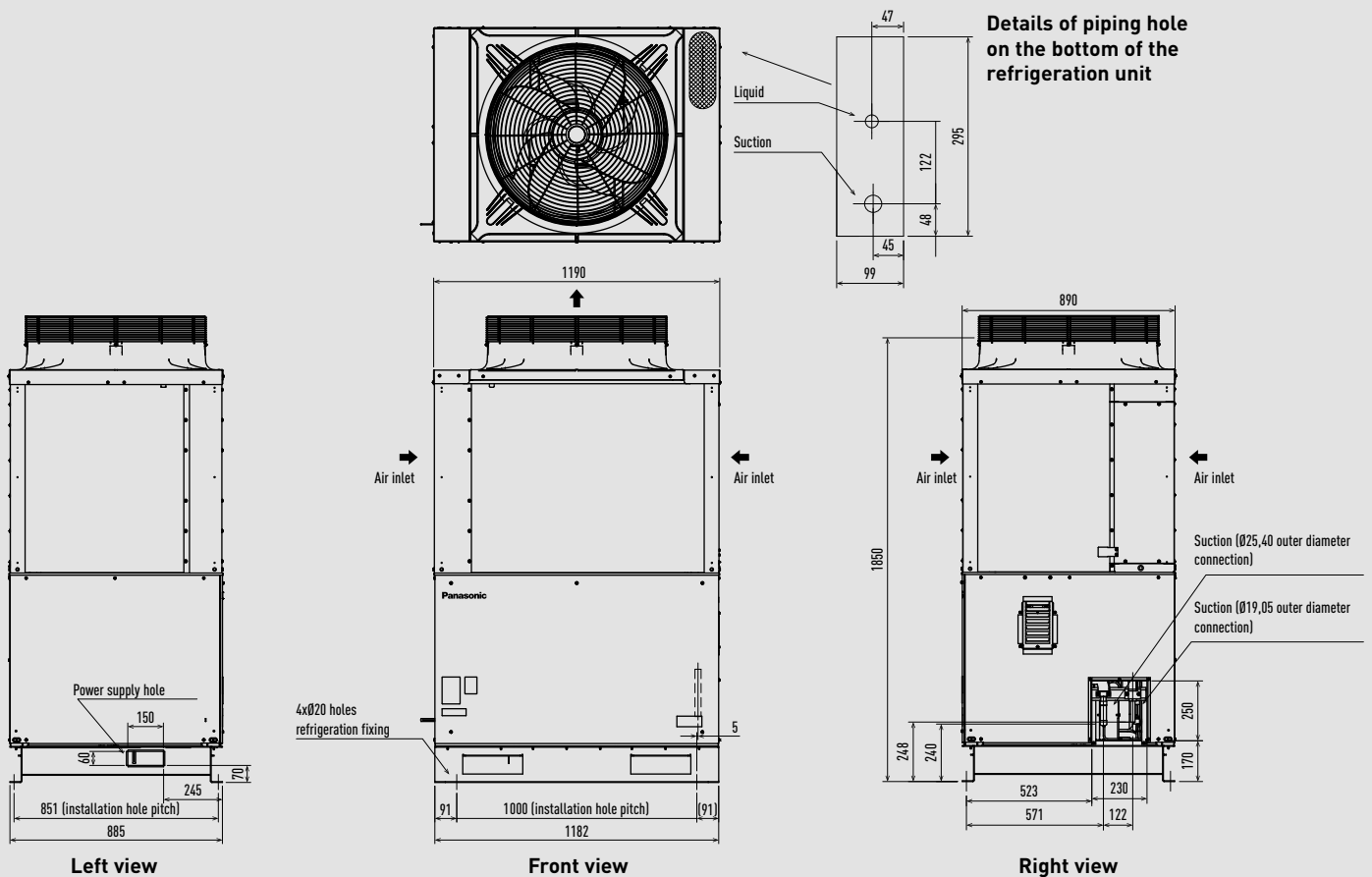

Unit: mm

# Wiring diagrams

## Domestic

Wall-mounted kits 1x1	→ 717
Floor console kits 1x1	→ 718
Low static pressure hide-away kits 1x1	→ 718
Multi system 2 rooms	→ 719
Multi system 3 rooms	→ 719
Multi system 4 rooms	→ 720
Multi system 5 rooms	→ 720

## Commercial

Wall-mounted Professional kits 1x1	→ 721
PACi NX wall-mounted kits 1x1	→ 721
PACi NX 4 way 60x60 cassette kits 1x1	→ 722
PACi NX 4 way 90x90 cassette kits 1x1	→ 722
PACi NX ceiling kits 1x1	→ 723
PACi NX adaptive ducted unit kits 1x1	→ 723
Big PACi NX hide-away kits 1x1	→ 724
PACi NX twin system	→ 724
PACi NX triple system	→ 725
PACi NX double-twin system	→ 725

## VRF Systems

Mini ECOi Series	→ 726
ECOi EX and ECO G Series	→ 727
Hybrid GHP/EHP	→ 727

**Please note: The wiring requirements indicated here are the minimum requirements in accordance with the installation instructions, please refer to the instructions for further details. Regulations on wire diameters and installation requirements differ from region to region. Please refer to your LOCAL ELECTRICAL CODES before commencing installation.**

## Wall-mounted kits 1x1.

Indoor unit



Outdoor unit



Attention: Wall-mounted Etherea and TZ super-compact have different connection terminals



Single phase  
Power supply  
230 V / 50 Hz



Infrared remote controller (included in the delivery)

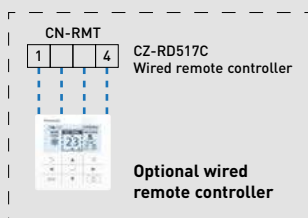

Power supply to indoor or outdoor depending on model, see table.

### Wall-mounted Heatcharge VZ - R32

Indoor unit	Power supply	Recommended fuse	Connection indoor / outdoor	Outdoor unit
CS-VZ9SKE	230 V (indoor)	16 A	4 x 1,5 mm <sup>2</sup>	CU-VZ9SKE
CS-VZ12SKE	230 V (indoor)	16 A	4 x 1,5 mm <sup>2</sup>	CU-VZ12SKE

### Wall-mounted Etherea Graphite grey, Silver and Matt white - R32

Indoor unit	Power supply	Recommended fuse	Power supply cable	Connection indoor / outdoor	Outdoor unit
CS-XZ20ZKEW-H / CS-XZ20ZKEW / CS-Z20ZKEW	230 V (indoor)	16 A	3 x 1,5 mm <sup>2</sup>	4 x 1,5 mm <sup>2</sup>	CU-Z20ZKE
CS-XZ25ZKEW-H / CS-XZ25ZKEW / CS-Z25ZKEW	230 V (indoor)	16 A	3 x 1,5 mm <sup>2</sup>	4 x 1,5 mm <sup>2</sup>	CU-Z25ZKE
CS-XZ35ZKEW-H / CS-XZ35ZKEW / CS-Z35ZKEW	230 V (indoor)	16 A	3 x 1,5 mm <sup>2</sup>	4 x 1,5 mm <sup>2</sup>	CU-Z35ZKE
CS-XZ42ZKEW-H / — / CS-Z42ZKEW	230 V (indoor)	16 A	3 x 1,5 mm <sup>2</sup>	4 x 1,5 mm <sup>2</sup>	CU-Z42ZKE
— / CS-XZ50ZKEW / CS-Z50ZKEW	230 V (indoor)	16 A	3 x 2,5 mm <sup>2</sup>	4 x 2,5 mm <sup>2</sup>	CU-Z50ZKE
— / — / CS-Z71ZKEW	230 V (indoor)	20 A	3 x 2,5 mm <sup>2</sup>	4 x 2,5 mm <sup>2</sup>	CU-Z71ZKE

### Wall-mounted TZ super-compact - R32

Indoor unit	Power supply	Recommended fuse	Power supply cable	Connection indoor / outdoor	Outdoor unit
CS-TZ20ZKEW	230 V (indoor)	16 A	3 x 1,5 mm <sup>2</sup>	4 x 1,5 mm <sup>2</sup>	CU-TZ20ZKE
CS-TZ25ZKEW	230 V (indoor)	16 A	3 x 1,5 mm <sup>2</sup>	4 x 1,5 mm <sup>2</sup>	CU-TZ25ZKE
CS-TZ35ZKEW	230 V (indoor)	16 A	3 x 1,5 mm <sup>2</sup>	4 x 1,5 mm <sup>2</sup>	CU-TZ35ZKE
CS-TZ42ZKEW	230 V (indoor)	16 A	3 x 1,5 mm <sup>2</sup>	4 x 1,5 mm <sup>2</sup>	CU-TZ42ZKE
CS-TZ50ZKEW	230 V (indoor)	16 A	3 x 2,5 mm <sup>2</sup>	4 x 2,5 mm <sup>2</sup>	CU-TZ50ZKE
CS-TZ60ZKEW	230 V (indoor)	20 A	3 x 2,5 mm <sup>2</sup>	4 x 2,5 mm <sup>2</sup>	CU-TZ60ZKE
CS-TZ71ZKEW	230 V (indoor)	20 A	3 x 2,5 mm <sup>2</sup>	4 x 2,5 mm <sup>2</sup>	CU-TZ71ZKE

### Wall-mounted BZ super-compact - R32

Indoor unit	Power supply	Recommended fuse	Power supply cable	Connection indoor / outdoor	Outdoor unit
CS-BZ25ZKE	230 V (indoor)	16 A	3 x 1,5 mm <sup>2</sup>	4 x 1,5 mm <sup>2</sup>	CU-BZ25ZKE
CS-BZ35ZKE	230 V (indoor)	16 A	3 x 1,5 mm <sup>2</sup>	4 x 1,5 mm <sup>2</sup>	CU-BZ35ZKE
CS-BZ50ZKE	230 V (indoor)	16 A	3 x 2,5 mm <sup>2</sup>	4 x 2,5 mm <sup>2</sup>	CU-BZ50ZKE
CS-BZ60ZKE	230 V (indoor)	20 A	3 x 2,5 mm <sup>2</sup>	4 x 2,5 mm <sup>2</sup>	CU-BZ60ZKE

### Wall-mounted UZ super-compact - R32

Indoor unit	Power supply	Recommended fuse	Power supply cable	Connection indoor / outdoor	Outdoor unit
CS-UZ25WKE	230 V (indoor)	16 A	3 x 1,5 mm <sup>2</sup>	4 x 1,5 mm <sup>2</sup>	CU-UZ25WKE
CS-UZ35WKE	230 V (indoor)	16 A	3 x 1,5 mm <sup>2</sup>	4 x 1,5 mm <sup>2</sup>	CU-UZ35WKE
CS-UZ50WKE	230 V (indoor)	16 A	3 x 2,5 mm <sup>2</sup>	4 x 2,5 mm <sup>2</sup>	CU-UZ50WKE

### Floor console kits 1x1.

Indoor unit



Infrared remote controller (included in the delivery)



Outdoor unit



Single phase Power supply 230 V / 50 Hz

#### Floor console - R32

Indoor unit	Power supply	Recommended fuse	Power supply cable	Connection indoor / outdoor	Outdoor unit
CS-Z25UFEAW	230 V (outdoor)	16 A	3 x 1,5 mm <sup>2</sup>	4 x 1,5 mm <sup>2</sup>	CU-Z25UBEA
CS-Z35UFEAW	230 V (outdoor)	16 A	3 x 1,5 mm <sup>2</sup>	4 x 1,5 mm <sup>2</sup>	CU-Z35UBEA
CS-Z50UFEAW	230 V (outdoor)	16 A	3 x 2,5 mm <sup>2</sup>	4 x 2,5 mm <sup>2</sup>	CU-Z50UBEA

### Low static pressure hide-away kits 1x1.

Indoor unit



CN-DISP CZ-RD52CP Included wired remote controller



Outdoor unit



Single phase Power supply 230 V / 50 Hz

#### Low static pressure hide-away - R32

Indoor unit	Power supply	Recommended fuse	Power supply cable	Connection indoor / outdoor	Outdoor unit
CS-Z25UD3EAW	230 V (outdoor)	16 A	3 x 1,5 mm <sup>2</sup>	4 x 1,5 mm <sup>2</sup>	CU-Z25UBEA
CS-Z35UD3EAW	230 V (outdoor)	16 A	3 x 1,5 mm <sup>2</sup>	4 x 1,5 mm <sup>2</sup>	CU-Z35UBEA
CS-Z50UD3EAW	230 V (outdoor)	16 A	3 x 2,5 mm <sup>2</sup>	4 x 1,5 mm <sup>2</sup>	CU-Z50UBEA
CS-Z60UD3EAW	230 V (outdoor)	16 A	3 x 2,5 mm <sup>2</sup>	4 x 1,5 mm <sup>2</sup>	CU-Z60UBEA

### Multi system 2 rooms.

Indoor unit

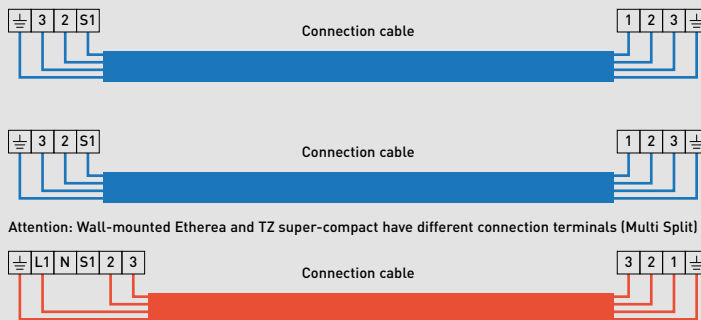

Attention: Wall-mounted Etherea and TZ super-compact have different connection terminals (Multi Split)

Outdoor unit



Single phase  
Power supply  
230 V / 50 Hz / 16 A

### Multi system - R32

Outdoor unit	Power supply	Recommended fuse	Power supply cable	Connection indoor / outdoor
CU-2Z35TBE	230 V	16 A	3 x 1,5 mm <sup>2</sup>	4 x 1,5 mm <sup>2</sup>
CU-2Z41TBE	230 V	16 A	3 x 1,5 mm <sup>2</sup>	4 x 1,5 mm <sup>2</sup>
CU-2Z50TBE	230 V	16 A	3 x 1,5 mm <sup>2</sup>	4 x 1,5 mm <sup>2</sup>
CU-2TZ41TBE	230 V	16 A	3 x 1,5 mm <sup>2</sup>	4 x 1,5 mm <sup>2</sup>
CU-2TZ50TBE	230 V	16 A	3 x 1,5 mm <sup>2</sup>	4 x 1,5 mm <sup>2</sup>
CU-2Z50ABEC	230 V	16 A	3 x 2,5 mm <sup>2</sup>	4 x 1,5 mm <sup>2</sup>

### Multi system 3 rooms.

Indoor unit

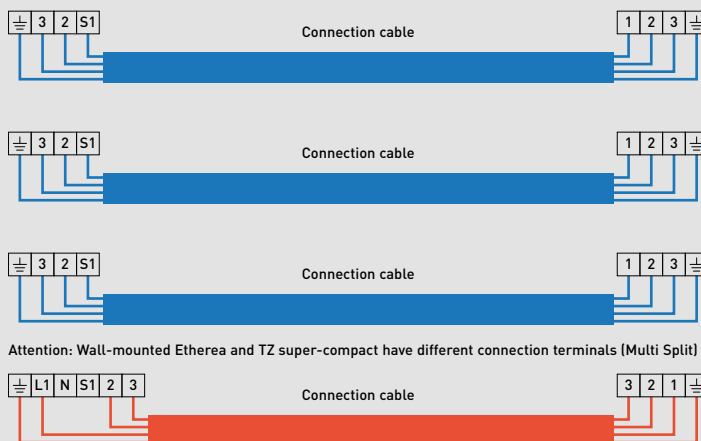
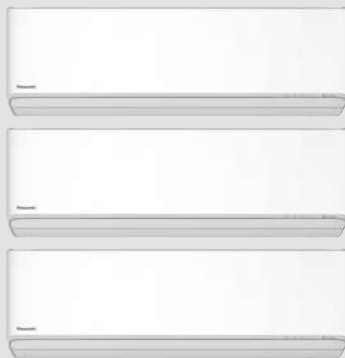

Attention: Wall-mounted Etherea and TZ super-compact have different connection terminals (Multi Split)

Outdoor unit



Single phase  
Power supply  
230 V / 50 Hz / 16 A

### Multi system - R32

Outdoor unit	Power supply	Recommended fuse	Power supply cable	Connection indoor / outdoor
CU-3Z52TBE	230 V	16 A	3 x 2,5 mm <sup>2</sup>	4 x 1,5 mm <sup>2</sup>
CU-3Z68TBE	230 V	16 A	3 x 2,5 mm <sup>2</sup>	4 x 1,5 mm <sup>2</sup>
CU-3TZ52TBE	230 V	16 A	3 x 2,5 mm <sup>2</sup>	4 x 1,5 mm <sup>2</sup>
CU-3Z75ABEC	230 V	16 A	3 x 2,5 mm <sup>2</sup>	4 x 1,5 mm <sup>2</sup>

### Multi system 4 rooms.

Indoor unit

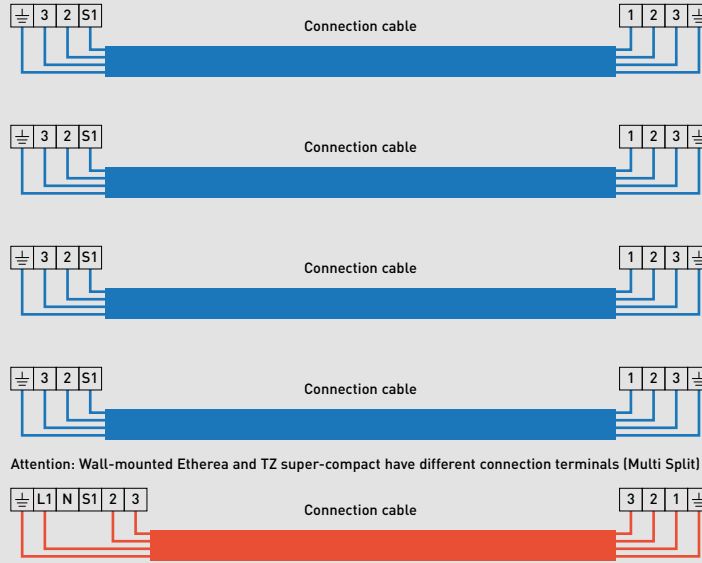

Attention: Wall-mounted Etherea and TZ super-compact have different connection terminals (Multi Split)

Outdoor unit



Single phase  
Power supply  
230 V / 50 Hz / 20 A

### Multi system · R32

Outdoor unit	Power supply	Recommended fuse	Power supply cable	Connection indoor / outdoor
CU-4Z68TBE	230 V	20 A	3 x 2,5 mm <sup>2</sup>	4 x 1,5 mm <sup>2</sup>
CU-4Z80TBE	230 V	20 A	3 x 2,5 mm <sup>2</sup>	4 x 1,5 mm <sup>2</sup>

### Multi system 5 rooms.

Indoor unit

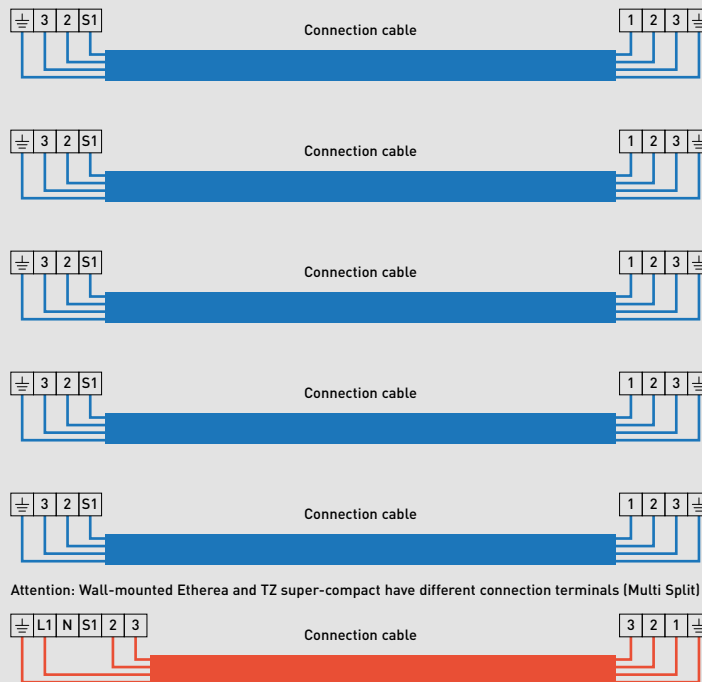
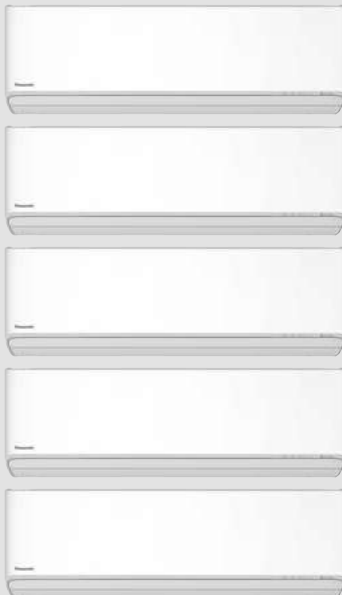

Attention: Wall-mounted Etherea and TZ super-compact have different connection terminals (Multi Split)

Outdoor unit



Single phase  
Power supply  
230 V / 50 Hz / 25 A

### Multi system · R32

Outdoor unit	Power supply	Recommended fuse	Power supply cable	Connection indoor / outdoor
CU-5Z90TBE	230 V	25 A	3 x 4,0 mm <sup>2</sup>	4 x 1,5 mm <sup>2</sup>



### Wall-mounted Professional kits 1x1.

Indoor unit



Outdoor unit

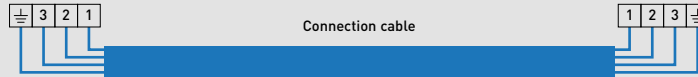

Single phase  
Power supply  
230 V / 50 Hz

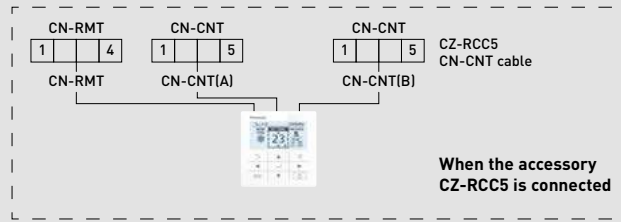
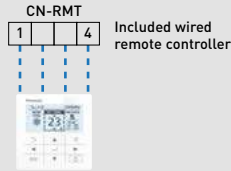

### Wall-mounted Professional -25 °C · R32

Indoor unit	Power supply	Recommended fuse	Connection indoor / outdoor	Outdoor unit
CS-Z25YKEA-1	230 V (indoor)	16 A	4 x 1,5 mm <sup>2</sup>	CU-Z25YKEA-1
CS-Z35YKEA-1	230 V (indoor)	16 A	4 x 1,5 mm <sup>2</sup>	CU-Z35YKEA-1
CS-Z42YKEA-1	230 V (indoor)	16 A	4 x 1,5 mm <sup>2</sup>	CU-Z42YKEA-1
CS-Z50YKEA-1	230 V (indoor)	16 A	4 x 2,5 mm <sup>2</sup>	CU-Z50YKEA-1
CS-Z71YKEA-1	230 V (indoor)	20 A	4 x 2,5 mm <sup>2</sup>	CU-Z71YKEA-1

### PACi NX wall-mounted kits 1x1.

Indoor unit

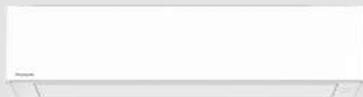

Outdoor unit

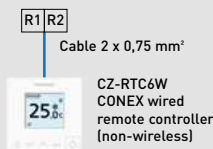

Single phase  
Power supply  
230 V / 50 Hz / \*

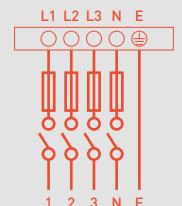

Three phase  
Power supply  
3 x 400 V / 1 N - 50 Hz / \*\*

#### Single phase

Indoor unit	Connection indoor / outdoor	Outdoor unit	Power supply	Circuit breaker*
S-2545PK4E	4 x 1,5 mm <sup>2</sup>	U-36PZH3E5	220/230/240V	20 A
S-5010PK4E	4 x 1,5 mm <sup>2</sup>	U-50PZH3E5		20 A
S-5010PK4E	4 x 1,5 mm <sup>2</sup>	U-60PZH3E5		25 A
S-5010PK4E	4 x 2,5 mm <sup>2</sup>	U-71PZH4E5		25 A
S-5010PK4E	4 x 2,5 mm <sup>2</sup>	U-100PZH4E5		35 A
S-2545PK4E	4 x 1,5 mm <sup>2</sup>	U-25PZ3E5		16 A
S-2545PK4E	4 x 1,5 mm <sup>2</sup>	U-36PZ3E5		16 A
S-5010PK4E	4 x 1,5 mm <sup>2</sup>	U-50PZ3E5		16 A
S-5010PK4E	4 x 1,5 mm <sup>2</sup>	U-60PZ3E5A		20 A
S-5010PK4E	4 x 1,5 mm <sup>2</sup>	U-71PZ3E5A		20 A
S-5010PK4E	4 x 2,5 mm <sup>2</sup>	U-100PZ3E5		35 A

#### Three phase

Indoor unit	Connection indoor / outdoor	Outdoor unit	Power supply	Circuit breaker**
S-5010PK4E	4 x 2,5 mm <sup>2</sup>	U-71PZH4E8	380/400/415V	16 A
S-5010PK4E	4 x 2,5 mm <sup>2</sup>	U-100PZH4E8		16 A
S-5010PK4E	4 x 2,5 mm <sup>2</sup>	U-100PZ3E8		16 A

PACi NX 4 way 60x60 cassette kits 1x1.

Indoor unit



Outdoor unit

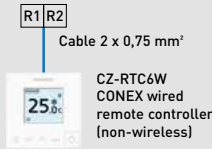

Single phase Power supply 230 V / 50 Hz / 16 A

Single phase

Indoor unit	Connection indoor / outdoor	Outdoor unit	Power supply	Circuit breaker
S-36PY3E	4 x 1,5 mm <sup>2</sup>	U-36PZH3E5	220/230/240 V	20 A
S-50PY3E	4 x 1,5 mm <sup>2</sup>	U-50PZH3E5		20 A
S-60PY3E	4 x 1,5 mm <sup>2</sup>	U-60PZH3E5		20 A
S-25PY3E	4 x 1,5 mm <sup>2</sup>	U-25PZ3E5		16 A
S-36PY3E	4 x 1,5 mm <sup>2</sup>	U-36PZ3E5		16 A
S-50PY3E	4 x 1,5 mm <sup>2</sup>	U-50PZ3E5		16 A
S-60PY3E	4 x 1,5 mm <sup>2</sup>	U-60PZ3E5A		20 A

PACi NX 4 way 90x90 cassette kits 1x1.

Indoor unit



Outdoor unit

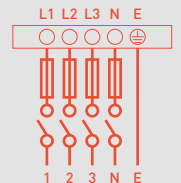
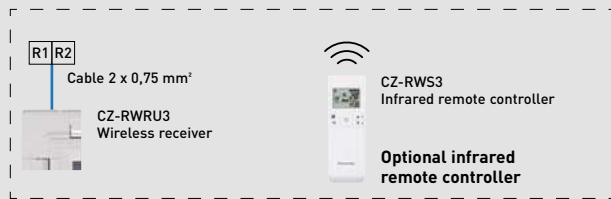
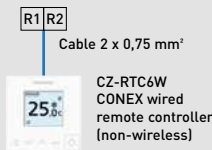

Single phase Power supply 230 V / 50 Hz / \*

Three phase Power supply 3 x 400 V / 1 N - 50 Hz / \*\*

Single phase

Indoor unit	Connection indoor / outdoor	Outdoor unit	Power supply	Circuit breaker*
S-3650PU3E	4 x 1,5 mm <sup>2</sup>	U-36PZH3E5	220/230/240 V	20 A
S-3650PU3E	4 x 1,5 mm <sup>2</sup>	U-50PZH3E5		20 A
S-6071PU3E	4 x 1,5 mm <sup>2</sup>	U-60PZH3E5		25 A
S-6071PU3E	4 x 2,5 mm <sup>2</sup>	U-71PZH4E5		25 A
S-1014PU3E	4 x 2,5 mm <sup>2</sup>	U-100PZH4E5		35 A
S-1014PU3E	4 x 2,5 mm <sup>2</sup>	U-125PZH4E5		40 A
S-1014PU3E	4 x 2,5 mm <sup>2</sup>	U-140PZH4E5		40 A
S-3650PU3E	4 x 1,5 mm <sup>2</sup>	U-36PZ3E5		16 A
S-3650PU3E	4 x 1,5 mm <sup>2</sup>	U-50PZ3E5		16 A
S-6071PU3E	4 x 1,5 mm <sup>2</sup>	U-60PZ3E5A		20 A
S-6071PU3E	4 x 1,5 mm <sup>2</sup>	U-71PZ3E5A		20 A
S-6010PU3E	4 x 2,5 mm <sup>2</sup>	U-100PZ3E5		35 A
S-1014PU3E	4 x 2,5 mm <sup>2</sup>	U-125PZ3E5		40 A
S-1014PU3E	4 x 2,5 mm <sup>2</sup>	U-140PZ3E5		40 A

Three phase

Indoor unit	Connection indoor / outdoor	Outdoor unit	Power supply	Circuit breaker**
S-6071PU3E	4 x 2,5 mm <sup>2</sup>	U-71PZH4E8	380/400/415 V	16 A
S-1014PU3E	4 x 2,5 mm <sup>2</sup>	U-100PZH4E8		16 A
S-1014PU3E	4 x 2,5 mm <sup>2</sup>	U-125PZH4E8		16 A
S-1014PU3E	4 x 2,5 mm <sup>2</sup>	U-140PZH4E8		16 A
S-1014PU3E	4 x 2,5 mm <sup>2</sup>	U-100PZ3E8		16 A
S-1014PU3E	4 x 2,5 mm <sup>2</sup>	U-125PZ3E8		20 A
S-1014PU3E	4 x 2,5 mm <sup>2</sup>	U-140PZ3E8		20 A

### PACi NX ceiling kits 1x1.

Indoor unit

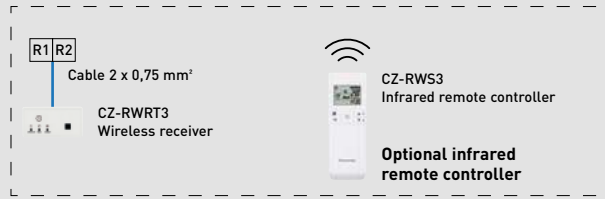
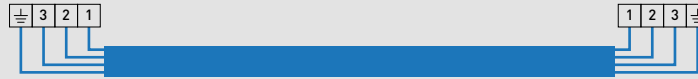
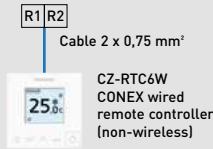

Outdoor unit

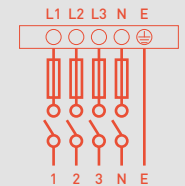

#### Single phase

Indoor unit	Connection indoor / outdoor	Outdoor unit	Power supply	Circuit breaker*
S-3650PT3E	4 x 1,5 mm <sup>2</sup>	U-36PZH3E5	220 / 230 / 240 V	20 A
S-3650PT3E	4 x 1,5 mm <sup>2</sup>	U-50PZH3E5		20 A
S-6071PT3E	4 x 1,5 mm <sup>2</sup>	U-60PZH3E5		25 A
S-6071PT3E	4 x 2,5 mm <sup>2</sup>	U-71PZH4E5		25 A
S-1014PT3E	4 x 2,5 mm <sup>2</sup>	U-100PZH4E5		35 A
S-1014PT3E	4 x 2,5 mm <sup>2</sup>	U-125PZH4E5		40 A
S-1014PT3E	4 x 2,5 mm <sup>2</sup>	U-140PZH4E5		40 A
S-3650PT3E	4 x 1,5 mm <sup>2</sup>	U-36PZ3E5		16 A
S-3650PT3E	4 x 1,5 mm <sup>2</sup>	U-50PZ3E5		16 A
S-6071PT3E	4 x 1,5 mm <sup>2</sup>	U-60PZ3E5A		20 A
S-6071PT3E	4 x 1,5 mm <sup>2</sup>	U-71PZ3E5A		20 A
S-6010PT3E	4 x 2,5 mm <sup>2</sup>	U-100PZ3E5		35 A
S-1014PT3E	4 x 2,5 mm <sup>2</sup>	U-125PZ3E5		40 A
S-1014PT3E	4 x 2,5 mm <sup>2</sup>	U-140PZ3E5		40 A

#### Three phase

Indoor unit	Connection indoor / outdoor	Outdoor unit	Power supply	Circuit breaker**
S-6071PT3E	4 x 2,5 mm <sup>2</sup>	U-71PZH4E8	380 / 400 / 415 V	16 A
S-1014PT3E	4 x 2,5 mm <sup>2</sup>	U-100PZH4E8		16 A
S-1014PT3E	4 x 2,5 mm <sup>2</sup>	U-125PZH4E8		16 A
S-1014PT3E	4 x 2,5 mm <sup>2</sup>	U-140PZH4E8		16 A
S-1014PT3E	4 x 2,5 mm <sup>2</sup>	U-100PZ3E8		16 A
S-1014PT3E	4 x 2,5 mm <sup>2</sup>	U-125PZ3E8		20 A
S-1014PT3E	4 x 2,5 mm <sup>2</sup>	U-140PZ3E8		20 A

### PACi NX adaptive ducted unit kits 1x1.

Indoor unit

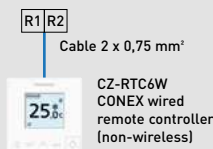

Outdoor unit

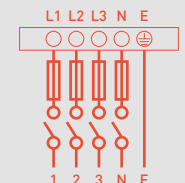

#### Single phase

Indoor unit	Connection indoor / outdoor	Outdoor unit	Power supply	Circuit breaker*
S-3650PF3E	4 x 1,5 mm <sup>2</sup>	U-36PZH3E5	220 / 230 / 240 V	20 A
S-3650PF3E	4 x 1,5 mm <sup>2</sup>	U-50PZH3E5		20 A
S-6071PF3E	4 x 1,5 mm <sup>2</sup>	U-60PZH3E5		25 A
S-6071PF3E	4 x 2,5 mm <sup>2</sup>	U-71PZH4E5		25 A
S-1014PF3E	4 x 2,5 mm <sup>2</sup>	U-100PZH4E5		35 A
S-1014PF3E	4 x 2,5 mm <sup>2</sup>	U-125PZH4E5		40 A
S-1014PF3E	4 x 2,5 mm <sup>2</sup>	U-140PZH4E5		40 A
S-3650PF3E	4 x 1,5 mm <sup>2</sup>	U-36PZ3E5		16 A
S-3650PF3E	4 x 1,5 mm <sup>2</sup>	U-50PZ3E5		16 A
S-6071PF3E	4 x 1,5 mm <sup>2</sup>	U-60PZ3E5A		20 A
S-6071PF3E	4 x 1,5 mm <sup>2</sup>	U-71PZ3E5A		20 A
S-6010PF3E	4 x 2,5 mm <sup>2</sup>	U-100PZ3E5		35 A
S-1014PF3E	4 x 2,5 mm <sup>2</sup>	U-125PZ3E5		40 A
S-1014PF3E	4 x 2,5 mm <sup>2</sup>	U-140PZ3E5		40 A

#### Three phase

Indoor unit	Connection indoor / outdoor	Outdoor unit	Power supply	Circuit breaker**
S-6071PF3E	4 x 2,5 mm <sup>2</sup>	U-71PZH4E8	380 / 400 / 415 V	16 A
S-1014PF3E	4 x 2,5 mm <sup>2</sup>	U-100PZH4E8		16 A
S-1014PF3E	4 x 2,5 mm <sup>2</sup>	U-125PZH4E8		16 A
S-1014PF3E	4 x 2,5 mm <sup>2</sup>	U-140PZH4E8		16 A
S-1014PF3E	4 x 2,5 mm <sup>2</sup>	U-100PZ3E8		16 A
S-1014PF3E	4 x 2,5 mm <sup>2</sup>	U-125PZ3E8		20 A
S-1014PF3E	4 x 2,5 mm <sup>2</sup>	U-140PZ3E8		20 A

### Big PACi NX high static pressure hide-away 20,0-25,0 kW kits 1x1.

Indoor unit

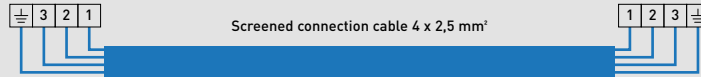

Outdoor unit

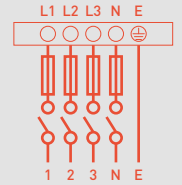
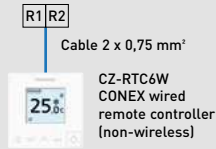

Three phase  
Power supply  
3 x 400 V / 1 N - 50 Hz

#### Three phase

Indoor unit	Outdoor unit	Power supply	Circuit breaker
S-200PE4E	U-200PZH4E8	380/400/415 V	20 A
S-250PE4E	U-250PZH4E8		25 A

### PACi NX twin system.

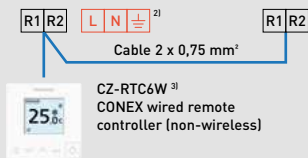
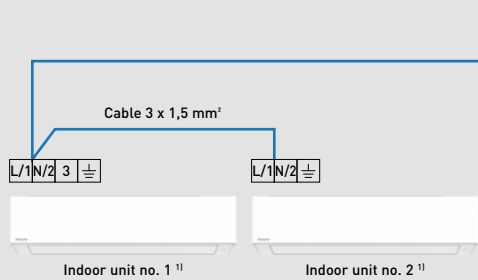

Outdoor unit

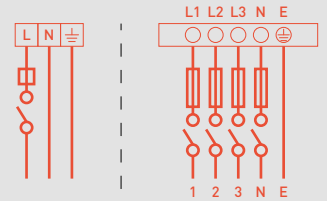

Single phase  
Power supply  
230 V / 50 Hz / \*

Three phase  
Power supply  
3 x 400 V / 1 N - 50 Hz / \*\*

#### Single phase

Outdoor unit	Power supply	Circuit breaker*
U-50PZH3E5	220/230/240 V	20 A
U-71PZH4E5		25 A
U-100PZH4E5		35 A
U-125PZH4E5		40 A
U-140PZH4E5		40 A
U-100PZ3E5		35 A
U-125PZ3E5		40 A
U-140PZ3E5		40 A

#### Three phase

Outdoor unit	Power supply	Circuit breaker**
U-71PZH4E8	380/400/415 V	16 A
U-100PZH4E8		16 A
U-125PZH4E8		16 A
U-140PZH4E8		16 A
U-200PZH4E8		20 A
U-250PZH4E8		30 A
U-100PZ3E8		16 A
U-125PZ3E8		20 A
U-140PZ3E8		20 A

1) Available system combinations vary by indoor unit type. 2) Optional connection of single phase power supply connection to unit no. 2. Please refer to installation instructions for details. 3) Optional infrared remote controller is also possible. Wireless receivers may be required depending on indoor units.

### PACi NX triple system.

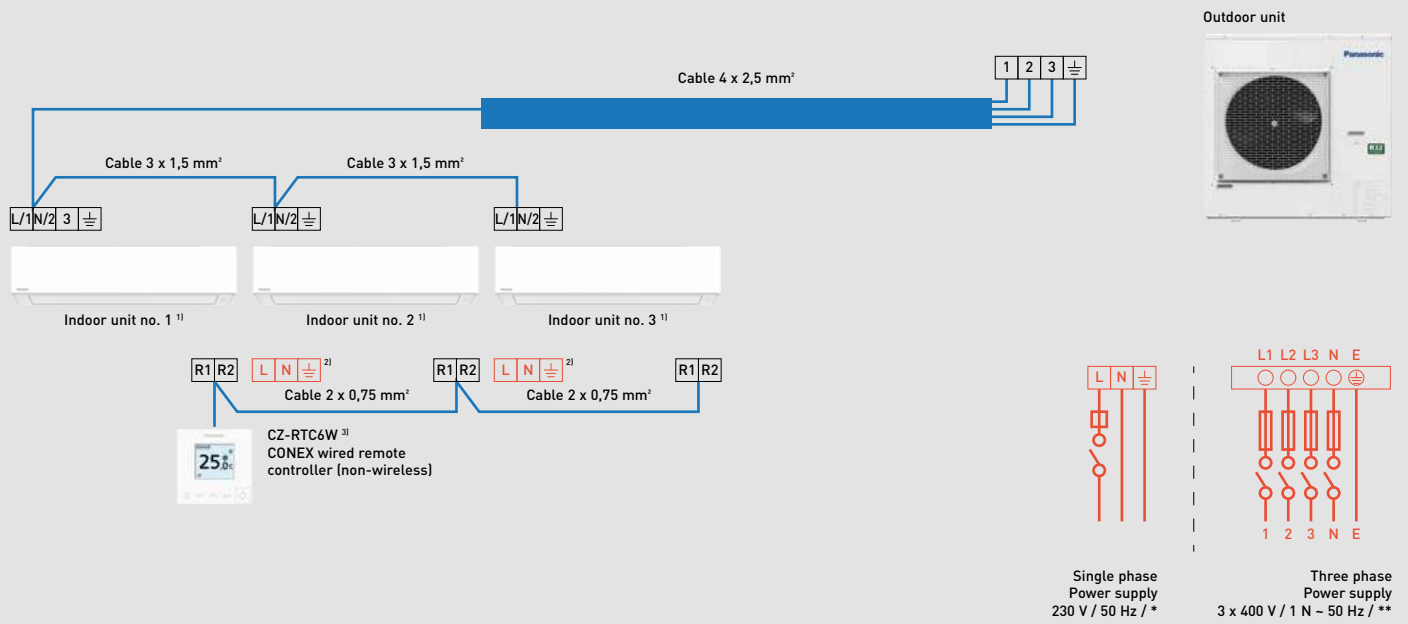

#### Single phase

Outdoor unit	Power supply	Circuit breaker*
U-71PZH4E5	220 / 230 / 240 V	25 A
U-100PZH4E5		35 A
U-125PZH4E5		40 A
U-140PZH4E5		40 A

1) Available system combinations vary by indoor unit type. 2) Optional connection of single phase power supply connection to unit no. 2 and unit no. 3. Please refer to installation instructions for details. 3) Optional infrared remote controller is also possible. Wireless receivers may be required depending on indoor units.

#### Three phase

Outdoor unit	Power supply	Circuit breaker**
U-71PZH4E8	380 / 400 / 415 V	16 A
U-100PZH4E8		16 A
U-125PZH4E8		16 A
U-140PZH4E8		16 A
U-200PZH4E8		20 A
U-250PZH4E8		25 A

### PACi NX double-twin system.

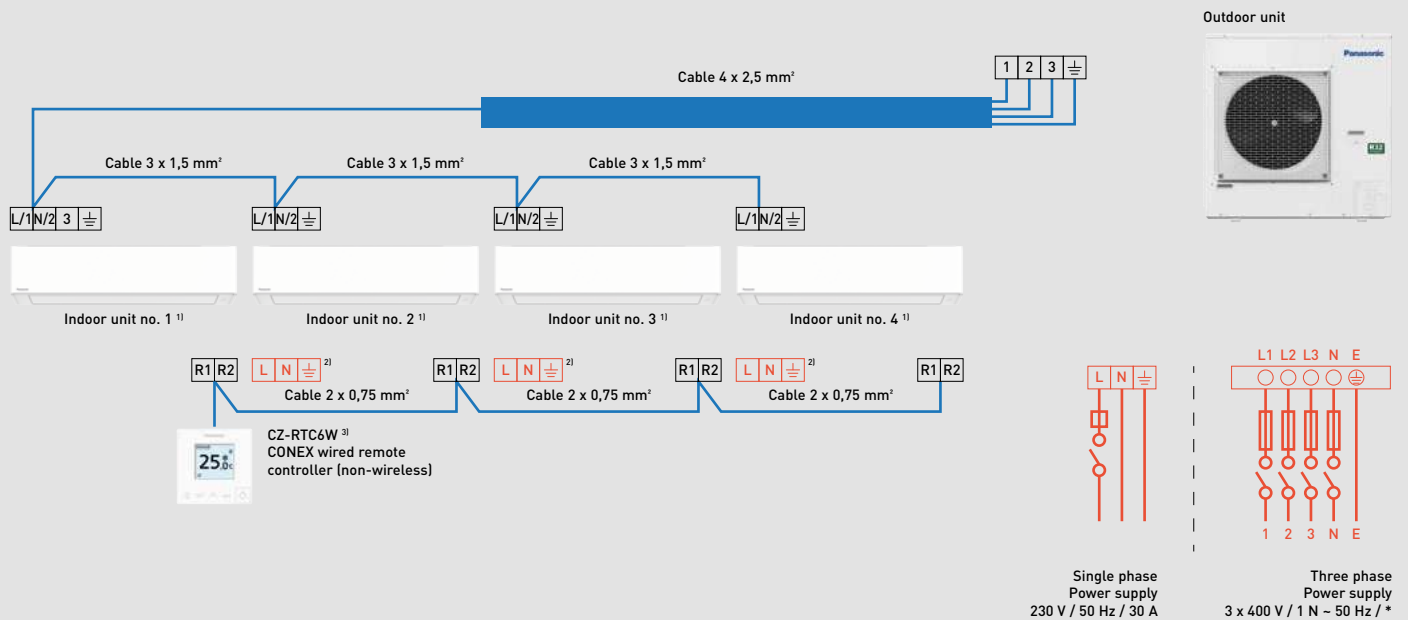

#### Single phase

Outdoor unit	Power supply	Circuit breaker
U-100PZH4E5	220 / 230 / 240 V	35 A
U-125PZH4E5		40 A

1) Available system combinations vary by indoor unit type. 2) Optional connection of single phase power supply connection to unit no. 2, unit no. 3 and unit no. 4. Please refer to installation instructions for details. 3) Optional infrared remote controller is also possible. Wireless receivers may be required depending on indoor units.

#### Three phase

Outdoor unit	Power supply	Circuit breaker*
U-100PZH4E8	380 / 400 / 415 V	16 A
U-125PZH4E8		16 A
U-200PZH4E8		20 A
U-250PZH4E8		25 A

Mini ECOi Series.

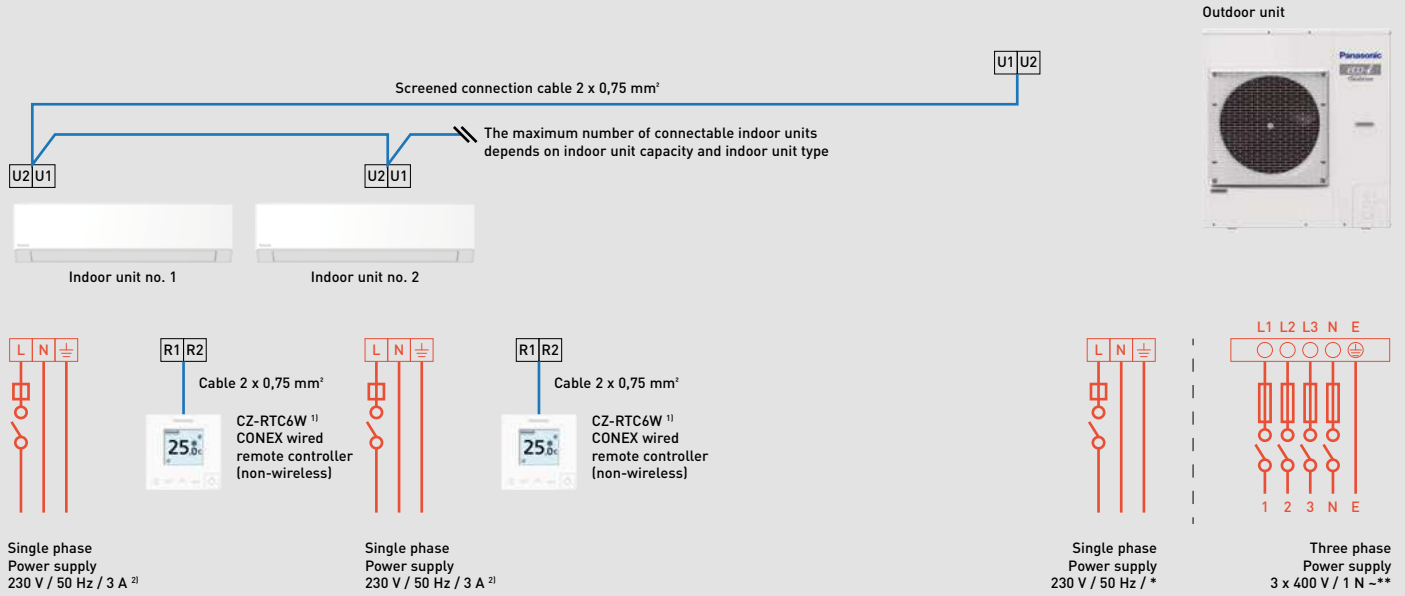

Single phase

Outdoor unit	Power supply	Circuit breaker*
U-4LZ2E5	220 / 230 / 240 V	20 A
U-5LZ2E5		25 A
U-6LZ2E5		30 A
U-4LE2E5		20 A
U-5LE2E5		25 A
U-6LE2E5		30 A

1) Optional infrared remote controller is also possible. Wireless receivers may be required depending on indoor units.  
 2) 10 A for single indoor connection to S-224ME2E5 / S-280ME2E5, in combination with U-8LE1E8 / U-10LE1E8.

Three phase

Outdoor unit	Power supply	Circuit breaker**
U-4LZ2E8	380 / 400 / 415 V	10 A
U-5LZ2E8		16 A
U-6LZ2E8		16 A
U-8LZ2E8		16 A
U-10LZ2E8		20 A
U-4LE2E8		10 A
U-5LE2E8		16 A
U-6LE2E8		16 A
U-8LE1E8		16 A
U-10LE1E8		20 A

ECOi EX and ECO G Series.

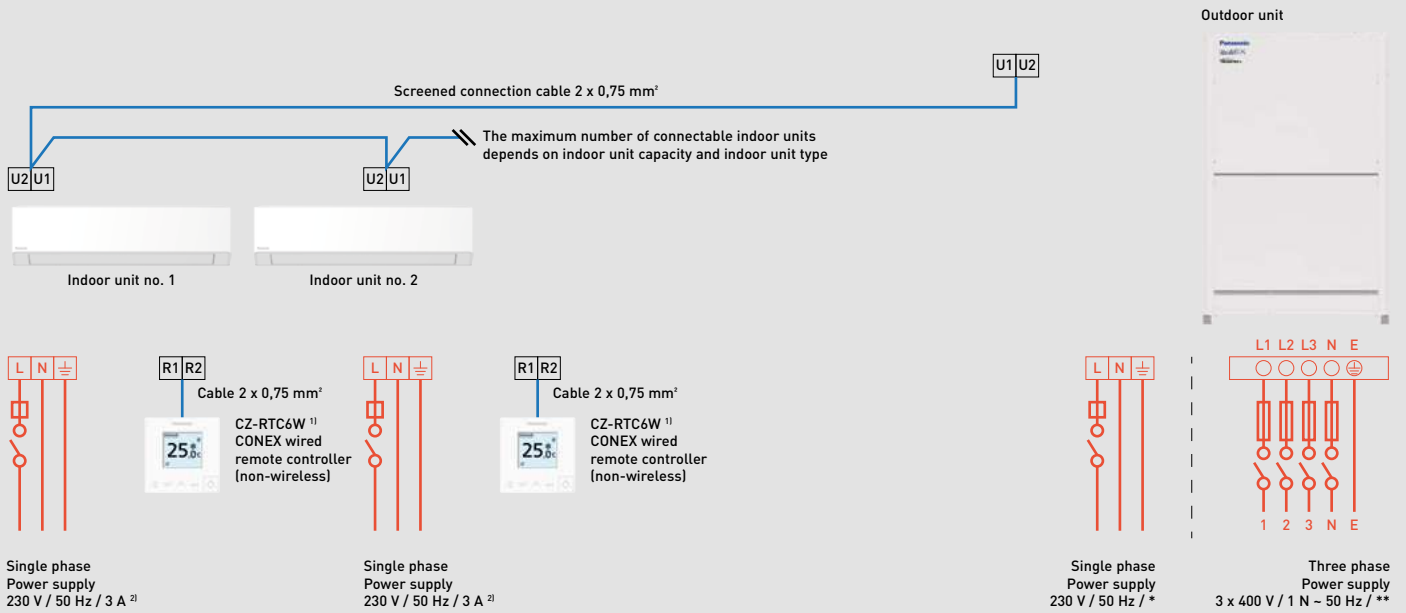

ECOi EX Series

2-Pipe		3-Pipe			
Outdoor unit	Power supply	Circuit breaker**	Outdoor unit	Power supply	Circuit breaker**
U-8MZ1E8		20 A	U-8MF3E8		16 A
U-10MZ1E8		25 A	U-10MF3E8	380 / 400 / 415 V	20 A
U-12MZ1E8		25 A	U-12MF3E8		25 A
U-8ME2E8		16 A	U-14MF3E8		40 A
U-10ME2E8	380 / 400 / 415 V	16 A	U-16MF3E8	30 A	
U-12ME2E8		20 A			
U-14ME2E8		25 A			
U-16ME2E8		30 A			
U-18ME2E8		40 A			
U-20ME2E8		40 A			

ECO G Series

2-Pipe		3-Pipe			
Outdoor unit	Power supply	Circuit breaker*	Outdoor unit	Power supply	Circuit breaker*
U-16GE3E5		16 A	U-16GF3E5	220 / 230 / 240 V	16 A
U-20GE3E5	220 / 230 / 240 V	16 A	U-20GF3E5		16 A
U-25GE3E5		16 A	U-25GF3E5		16 A
U-30GE3E5		16 A			

- 1) Optional infrared remote controller is also possible. Wireless receivers may be required depending on indoor units.
- 2) 10 A for single indoor connection to S-224ME2E5 / S-280ME2E5.

Hybrid GHP/EHP.

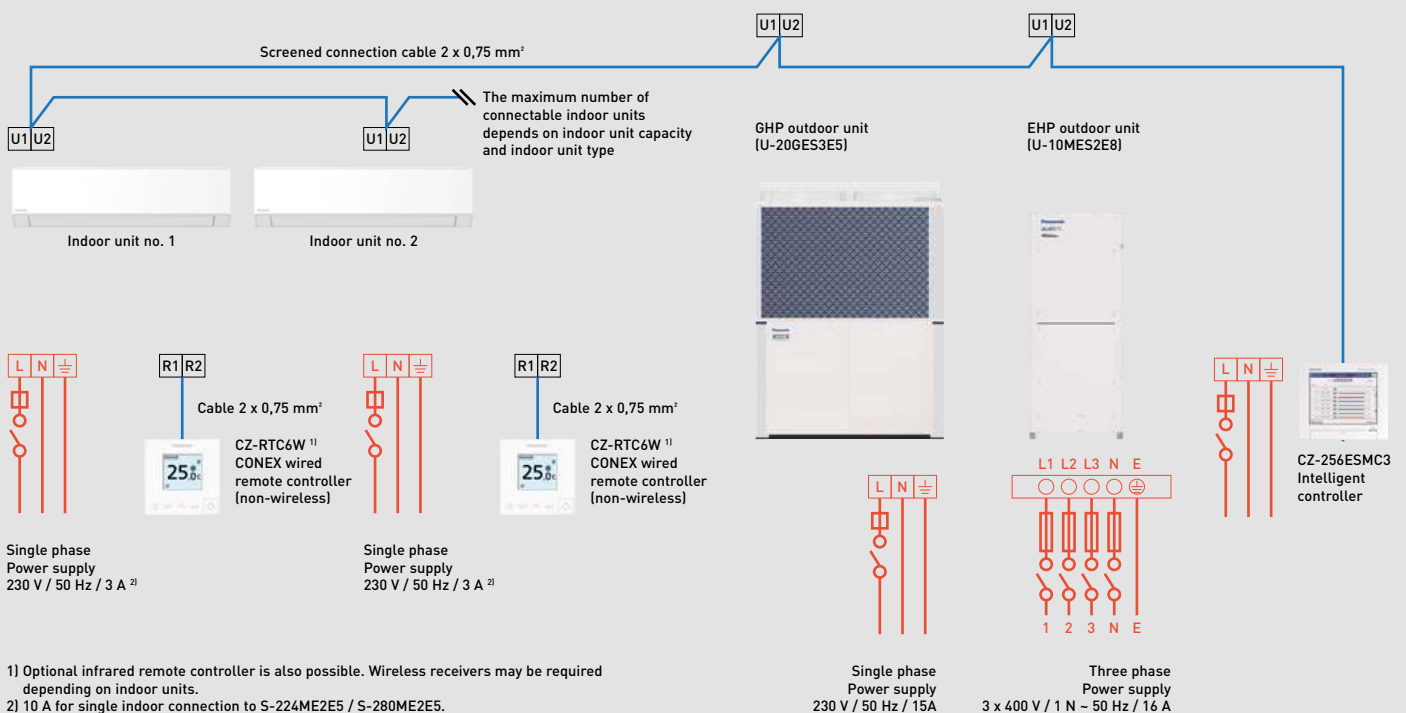

- 1) Optional infrared remote controller is also possible. Wireless receivers may be required depending on indoor units.
- 2) 10 A for single indoor connection to S-224ME2E5 / S-280ME2E5.

# Notes

A large grid of small dots for taking notes, consisting of 20 columns and 40 rows.



# Notes

A large grid of small dots, intended for taking notes.

## Panasonic service

Our Panasonic Service teams are committed to ensuring your peace of mind. Best service is our aim.

Panasonic provides a team of highly trained technicians and engineers to deliver professional and responsive services that meet the highest levels of quality and safety while being efficient and cost effective.

To find out more about Panasonic Heating & Cooling Solutions, please visit [www.aircon.panasonic.eu](http://www.aircon.panasonic.eu).



### Maintenance.

To meet the requirements of the standard warranty, the product must be maintained and serviced annually by a suitably trained and qualified engineer. This way we can extend the lifetime of the product.



### Repair.

Panasonic offers a wide range of service agreements, like Panasonic Service+ for a maximized product lifetime. Leave the care of your Panasonic products to the experts. In the unlikely event that something goes wrong, trust one of our qualified and Panasonic trained experts to get things back on track.



### Warranty.

In accordance with the regulations, Panasonic guarantees its products against hidden defects. Moreover, Panasonic grants to the professional purchaser a commercial warranty, specific to the product families, subject to compliance of all the rules of installation and use of its products.

## Panasonic Heating & Cooling Solutions customer service

Panasonic enables different channels for end users or professionals to get in touch with us:

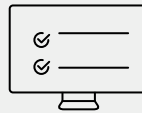

Use our European website [www.aircon.panasonic.eu](http://www.aircon.panasonic.eu) for contacting us.

Panasonic has implemented a contact page on the Panasonic Heating & Cooling Solutions website for potential or existing Panasonic customers.



Another option is to contact the highly experienced teams at the Panasonic customer service center, who are more than qualified to support Panasonic clients in 13 different languages across Europe.

### Our service center in Europe for end customers:

Country	B2C support center	Opening times
Spain	900 82 87 87	Mo-Fr 9-17h
Portugal	800 78 22 20	Mo-Fr 9-17h
France	0800 805 215	Mo-Fr 9-17h
Italy	+39 2 6433235	Mo-Fr 9-17h
United Kingdom	0808 208 2115	Mo-Fr 9-17h
Ireland	1800 939 977	Mo-Fr 9-17h
Poland	800 080 911	Mo-Fr 9-17h
Denmark	+45 89 87 45 00	Mo-Fr 9-17h
Sweden	+46 85 221 81 00	Mo-Fr 9-17h
Finland	+35 8646041590	Mo-Fr 9-17h

Country	B2C support center	Opening times
Norway	+47 69 67 61 00	Mo-Fr 9-17h
Germany	+49 611 71187211	Mo-Sat 7-18h
Hungary	+36 1 700 89 65	Mo-Fr 9-17h
Switzerland DE	+41 415615366	Mo-Fr 9-17h
Switzerland FR	+41 435880049	Mo-Fr 9-17h
Switzerland IT	+41 435880048	Mo-Fr 9-17h
The Netherlands	+31 73 6402 538	Mo-Sat 7-18h
Belgium NL	+32 2 320 55 38	Mo-Fr 9-17h
Belgium FR	+32 2 320 55 38	Mo-Fr 9-17h
Luxemburg	+32 2 320 55 38	Mo-Fr 9-17h



**Panasonic**

heating & cooling solutions

**Panasonic Marketing Europe GmbH**  
**Panasonic Heating & Ventilation Air-Conditioning Europe**

Hagenauer Strasse 43, 65203 Wiesbaden, Germany  
**www.aircon.panasonic.eu**

**Ireland**

**Panasonic Heating & Cooling Solutions**

1 The Courtyard, Kiltcarbery Business Park, Nangor  
 Road, Dublin D22 R791, Ireland  
 ☎ 1800 939 977  
 www.aircon.panasonic.ie

**France / Belgium / Luxembourg**

**Panasonic Solutions Chauffage & Refroidissement**

1 à 7 Rue du 19 Mars 1962, 92238, Gennevilliers  
 Cedex, France  
 ☎ 0800 805 215 (France)  
 +32 2 320 55 38 (Belgium & Luxembourg)  
 www.aircon.panasonic.eu

**Germany / Austria / Switzerland**

**Panasonic Heiz- & Kühlsysteme**

Hagenauer Str. 43, 65203 Wiesbaden, Germany  
 +49 611 711 87 211 (Germany)  
 ☎ +43 1 253 22 120 (Austria)  
 +41 41 561 53 66 (Switzerland)  
 HLK-Support-DE@eu.panasonic.com (Germany)  
 ☎ HLK-Support-AT@eu.panasonic.com (Austria)  
 HLK-Support-CH@eu.panasonic.com (Switzerland)  
 www.aircon.panasonic.eu

**Poland**

**Panasonic Heating & Cooling Solutions**

Wotoska 9, 02-583, Warszawa, Polska  
 ☎ 800 080 911  
 ☎ info.pl@panasonicproclub.com  
 www.aircon.panasonic.pl

**The Netherlands**

**Panasonic Heating & Cooling Solutions**

Europalaan 28E, 5332 BC, 's-Hertogenbosch,  
 The Netherlands  
 ☎ +31 736 402 538  
 www.aircon.panasonic.nl

**Spain / Portugal**

**Panasonic Heating & Cooling Solutions**

WTC Almeda Park, plaza de la Pau s/n, Edificio 6,  
 planta 4ª, Local D – 08940 Cornellà de Llobregat,  
 Spain  
 ☎ 900 82 87 87 (Spain)  
 ☎ 800 78 22 20 (Portugal)  
 www.aircon.panasonic.eu

**Italy / Malta / Cyprus / Greece**

**Panasonic Heating & Cooling Solutions**

Viale dell'Innovazione, 3, 20126, Milano, Italy  
 ☎ +39 02 6433235 (Customer Service)  
 www.aircon.panasonic.eu

**Sweden / Denmark / Norway / Finland**

**Panasonic Heating & Cooling Solutions**

Sundbybergsvägen 1, 171 73 Solna, Sweden  
 +46 85 221 81 00 (Sweden)  
 ☎ +45 89 87 45 00 (Denmark)  
 ☎ +47 69 67 61 00 (Norway)  
 +35 86 46 04 15 90 (Finland)  
 www.aircon.panasonic.eu

**Czech Republic / Slovakia**

**Panasonic Heating & Cooling Solutions**

Křižíkova 148/34, 186 00 Praha 8, Czech Republic  
 ☎ +420 236 032 911  
 ☎ panasonic.praha@eu.panasonic.com  
 www.aircon.panasonic.cz

**Hungary / Albania / Bosnia / Bulgaria / Croatia / Kosovo / Montenegro / Romania / Serbia / Slovenia**

**Panasonic Heating & Cooling Solutions**

Alíz utca 3. – Office Garden III, 1117 Budapest,  
 Hungary  
 ☎ +36 1 700 89 65  
 ☎ panasonicaquarea@eu.panasonic.com  
 www.aircon.panasonic.eu

**United Kingdom**

**Panasonic Heating & Ventilation Air-Conditioning UK Ltd.**

Building 3, Albany Place, Hydeway, Welwyn Garden City, AL7 3BT, United Kingdom  
 ☎ +44 1707 378 670  
 ☎ sales.PHVACUK@eu.panasonic.com  
**www.aircon.panasonic.co.uk**



Do not add or replace refrigerant other than the specified type. Manufacturer is not responsible for the damage and deterioration in safety due to usage of the other refrigerant.  
 The outdoor units in this catalogue contains fluorinated greenhouse gases with a GWP higher than 150.

**Panasonic®**

To find out how Panasonic cares for you,  
 log on to: **www.aircon.panasonic.eu**

**Panasonic Marketing Europe GmbH**  
**Panasonic Heating & Ventilation Air-conditioning Europe**  
 Hagenauer Strasse 43, 65203 Wiesbaden, Germany